



BELT DRIVE

Preventive Maintenance + Safety

Safety, installation, storage, handling, and troubleshooting.

TABLE OF CONTENTS

Safety Policy	1
Sources of Drive Problems	2
Preventive Maintenance	3
Safety	4
Drive Shutdown & Thorough Inspection	
Simple Inspection	5
Preventive Maintenance Checklist	6
Preventive Maintenance Procedure	7
Measuring Belt Tension	8
Installation	14
Belt Storage & Handling	18
Belt Identification	20
Belt Types	25
Belt Styles	28
Static Conductive Belts	30
Belt Drive Performance	31
Noise	33
Sprocket Corrosion Prevention	35
Troubleshooting Guide	37
Problem/Solution Summary Table	39
Maintenance Tools	48
Technical Information	51
NEMA Minimum Diameters	52
Minimum Recommended Diameters	54
Installation & Tensioning Allowances	56
Idler Hardware	60
Drive Survey Worksheet	
High Speed	63
Low Speed	64
Design IQ	65
Trademarks & Warranty	66

SAFETY POLICY

Warning! Be Safe! Gates belt drive systems are very reliable when used safely and within Gates application recommendations. However, there are specific **USES THAT MUST BE AVOIDED** due to the risk of serious injury or death. These prohibited misuses include:

Primary In-Flight Aircraft Systems

Do not use Gates belts, pulleys or sprockets on aircraft, propeller or rotor drive systems or in-flight accessory drives. Gates belt drive systems are not intended for aircraft use.

Lift Systems

Do not use Gates belts, pulleys or sprockets in applications that depend solely upon the belt to raise/lower, support or sustain a mass without an independent safety backup system. For applications requiring special "Lift" or "Proof" type chains with minimum tensile strength or certified/test tensile strength requirements, be advised that because Gates belts have different drive design procedures from metal chains, the tensile strength of a belt when compared to the tensile strength of a chain should only be a part of the design process. Diligent analysis with the customer's participation should be used when considering any such application.

Braking Systems

Do not use Gates belts, pulleys or sprockets in applications that depend solely upon the belt to slow or stop a mass, or to act as a brake without an independent safety backup system. Gates belt drive systems are not intended to function as a braking device in "emergency stop" systems.

DRIVE DESIGN SOFTWARE

Drive design software can be found at www.gates.com/drivedesign.

This software assists designers in quickly selecting optimum drive solutions.



SOURCES OF DRIVE PROBLEMS

Improper Belt or Pulley Installation

- Rolling or prying on belts
- Misalignment
- Incorrect tension
- Improper handling of belts
- Mis-matched belts and/or pulley used
- Idler not taking tension up correctly
- Guard interference

Poor Drive Design

- Sub-minimal diameters
- Under-designed drive
- Over-designed drive
- Excessive rim speed
- Incorrect belt type

Improper Belt Storage or Handling

- Temperature
- High Humidity
- Storing for too long
- Too near ozone generating equipment
- Exposed to sunlight

Environmental Factors

- Dust
- Debris
- Water/humidity
- Oil/grease
- Heat/cold
- Rust

Improper Drive Maintenance

- No retensioning
- Not replacing worn sheave
- Not cleaning guards
- Not checking for weak bracketry & drive components
- Not checking alignment

Defective Drive Components

- Check for worn pulleys or sheaves
- Check for cracked or weakened bracketry
- Check for weak mounting brackets
- Check for worn belts
- Check for nonfunctioning idlers
- Check for damaged guards

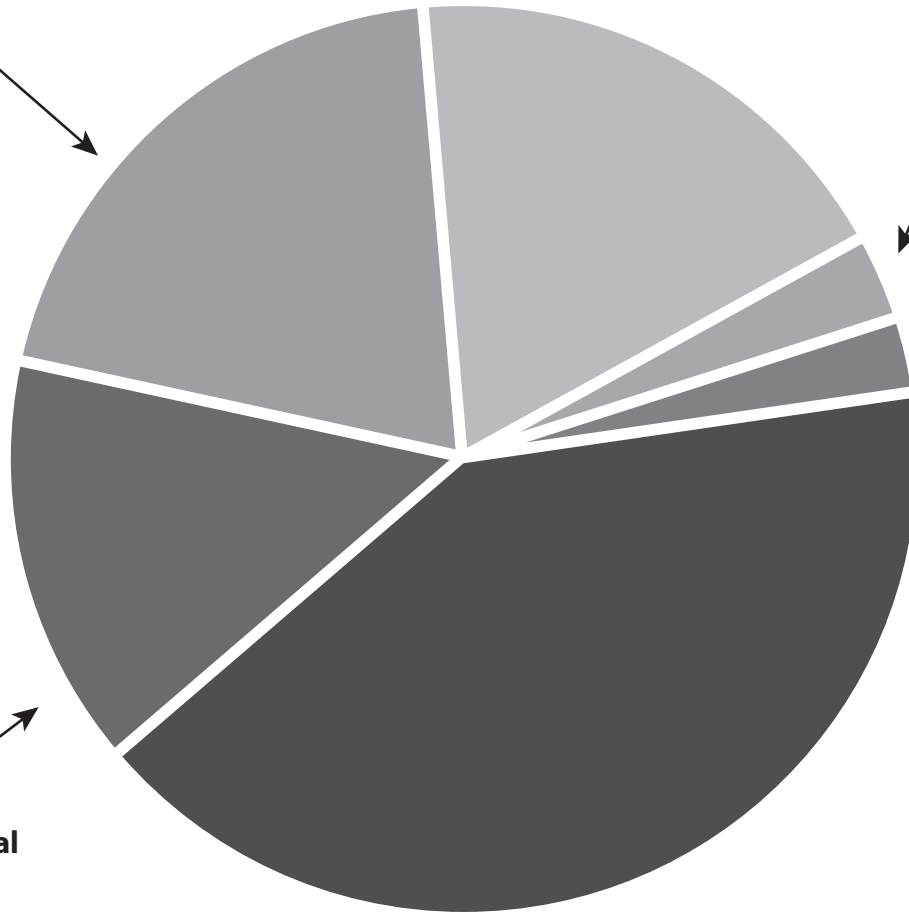

PREVENTIVE MAINTENANCE

Why have a preventive maintenance program?

When compared to the constant lubrication problems associated with chain drives, or the mechanical problems and high costs associated with gear drives, belts are the most cost-effective, reliable means of power transmission.

However, optimum belt drive performance requires proper maintenance. The potential for long service life is built into every Gates belt. When coupled with a regularly scheduled maintenance program, belt drives will run relatively trouble-free for a long time.



Power should be shut off and controls locked before inspecting

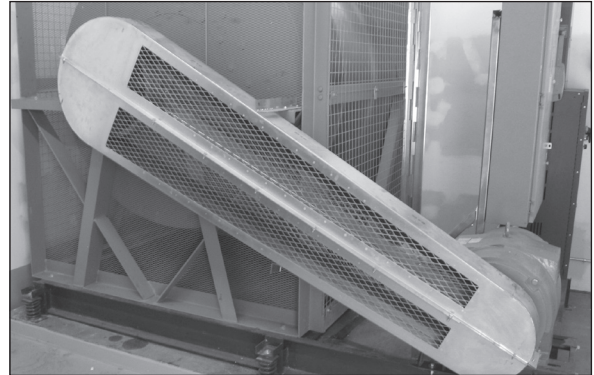

Belt drive should have adequate guard



Carefully inspect all belts

** Note - If belt looks bad, it probably is*

Important to your business

An effective preventive maintenance program saves time and money. Inspecting and replacing belts and faulty drive components before they fail will reduce costly downtime and production delays.

What is a good belt maintenance program?

A comprehensive, effective program of preventive maintenance consists of several elements:

- Maintaining a safe working environment.
- Regularly scheduled belt drive inspections.
- Proper belt installation procedures.
- Belt drive performance evaluations.
- Belt product knowledge.
- Belt storage and handling.
- Troubleshooting.

SAFETY

Maintaining A Safe Working Environment

It is common sense to establish a safe working environment in and around belt drives. The following precautions will make belt drive inspection and maintenance easier and safer.



Power should be shut off and controls locked before inspecting

Wear Proper Clothing

Never wear loose or bulky clothes, such as neckties, exposed shirttails, loose sleeves or loose lab coats around belt drives. Remove jewelry and tie up or restrain long hair. Wear gloves while inspecting sheaves or sprockets to avoid being cut by nicks, burrs or sharply worn pulley edges. Wear safety glasses to avoid eye injuries. Don't be foolish! Wear proper clothing. Always wear proper personal protective equipment, including gloves, eye & ear protection, steel toe shoes, and a hard hat.



No loose or bulky clothing. This technician's bulky lab coat is a hazard near moving components

Maintain Safe Access to Drives

Always maintain safe access to the belt drives. Keep area around drives free of clutter, debris and other obstructions. Floors should be clean and free of oil and debris to insure good footing and balance while working on machinery.



Don't clutter area around belt drive

Drive Guards

Always keep drives properly guarded. Every belt drive must be guarded when in operation. Guard must be designed and installed according to OSHA standards.

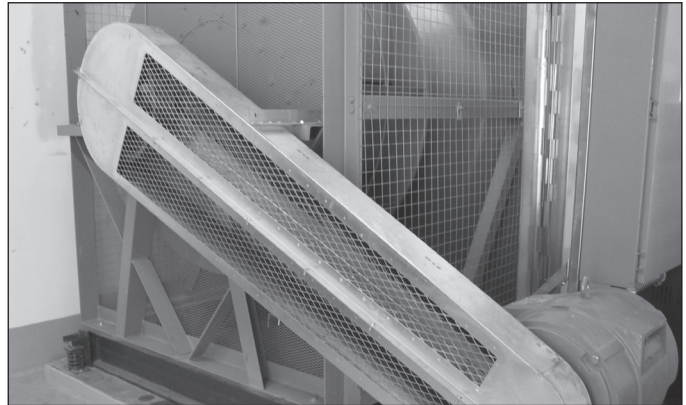

A properly guarded belt drive

A Properly Guarded Belt Drive

A properly designed guard has the following features:

- Completely encloses drive.
- Grills or vents for good ventilation.
- Accessible inspection door or panels.
- Can easily be removed and replaced if damaged.
- Where necessary, should protect the drive from weather, debris and damage.

Follow these precautions to make your preventive maintenance easier.

DRIVE SHUTDOWN & THOROUGH INSPECTION

Simple Drive Inspection

Begin preventive maintenance with a periodic drive inspection as a normal part of your maintenance rounds. Look and listen for any unusual vibration or sound while observing the guarded drive in operation. A well designed and maintained drive will operate smoothly and quietly.

Inspect guard for looseness or damage. Keep it free of debris or dust and grime buildup on either the inside or the outside of the guard. Any accumulation of material on the guard acts as insulation and could cause drives to run hotter.

The effect of temperature on belt life is important. For example, an internal temperature increase of 18°F (or approximately 36°F rise in ambient drive temperature) may cut belt life in half. Beware of hot surfaces and the potential for injury.

Also look for oil or grease dripping from guard. This may indicate over-lubricated bearings. If this material gets on rubber belts, they may swell and become distorted, leading to early belt failure.

It's a good idea to check motor mounts for proper tightness. Check take-up slots or rails to see that they are clean and lightly lubricated.

How Often To Inspect

The following factors influence how often to inspect a drive.

- Critical nature of equipment
- Drive operating cycle
- Accessibility of equipment
- Drive operating speed
- Environmental factors
- Temperature extremes in environment

Experience with specific equipment is the best guide to how often to inspect belt drives. Drives operating at high speeds, heavy loads, frequent stop/start conditions and at temperature extremes or operating on critical equipment require frequent inspection.

When To Perform Preventive Maintenance

To help establish a preventive maintenance schedule, keep the following in mind.

Critical Drives

A quick visual and noise inspection may be needed every one to two weeks.

Normal Drives

With most drives, a quick visual and noise inspection can be performed once a month.

Complete Inspection

A drive shutdown for a thorough inspection of belts, sheaves or sprockets and other drive components may be required every three to six months.

Remember, a well-designed industrial belt drive is capable of operating for several years when properly maintained and used under normal conditions.

Follow the Preventive Maintenance Procedure on the following page when performing detailed maintenance during equipment shutdowns.

DRIVE SHUTDOWN & THOROUGH INSPECTION

Preventive Maintenance Check List

By following these steps, belt drives can be maintained efficiently and safely.

1. Always turn off the power to the drive. Lock the control box and tag it with a warning sign "Down For Maintenance. Do Not Turn Power On."
Make sure the power is turned off for the correct drive. Never have contact with a belt drive unless the system is tagged and locked out.
2. Test to make sure correct circuit has been turned off.
3. Place all machine components in a safe (neutral) position. Make sure that moving components are locked down or are in a safe position. Make sure that fans cannot unexpectedly freewheel.
4. Beware of pinch points. Keep hands and fingers clear, especially where belts enter sheaves and sprockets.
5. Remove guard and inspect for damage. Check for signs of wear or rubbing against drive components. Clean and realign guard to prevent rubbing if necessary.
6. Inspect belt for wear or damage. Replace as needed.
7. Inspect sheaves or sprockets for wear and misalignment. Replace if worn.



Turn off power, lock controls and tag

8. Inspect other drive components such as bearings, shafts, motor mounts and take-up rails.
9. Inspect static conductive grounding system (if used) and replace components as needed.
10. Check belt tension and adjust as needed.
11. Recheck sheave or sprocket alignment.
12. Reinstall belt guard.
13. Turn power back on and restart drive. Look and listen for anything unusual.

DRIVE SHUTDOWN & THOROUGH INSPECTION

Preventive Maintenance Procedure

Once the power is off, locked and tagged, and the machine components are in safe positions, remove the guard and begin the inspection.

How to Inspect a Belt

Observing signs of unusual belt wear or damage will help troubleshoot possible drive problems.

Mark or note a point on the belt, or on one of the belts in a multiple V-belt drive. Wearing gloves, work around the belt(s), checking for cracks, frayed spots, cuts, or unusual wear patterns. Beware of pinch points. Keep hands and fingers clear, especially where belts enter sheaves and sprockets.



Begin by inspecting the belt

Check the belt for exposure to excessive heat. Excessive heat can come from a hot environment or from belt slip that generates heat. A typical maximum environmental temperature for a properly maintained V-belt is 160°F to 180°F. The maximum environmental temperature for a properly maintained synchronous belt is 185°F.

Rubber belts that are running hot, or running in a hot environment will harden and develop cracks from the bottom of the belt upwards.

Refer to the PROBLEM/SOLUTION SUMMARY TABLE for other symptoms.

Belts should be replaced if there are obvious signs of cracking, fraying, unusual wear or loss of teeth.

How to Check Alignment

While the drive is shut down, it is a good idea to check the sheaves or sprockets for proper alignment.

To check alignment, use a straight edge, string, or Gates EZ Align® laser alignment tool.



Using a straight edge to check alignment



Using a string to check alignment



Using EZ Align® laser alignment tool on both ends

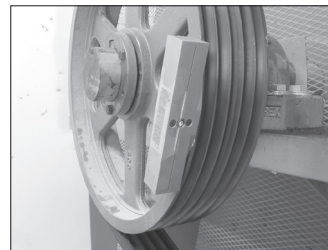

Using EZ Align® laser alignment tool, showing reflected laser on emitter

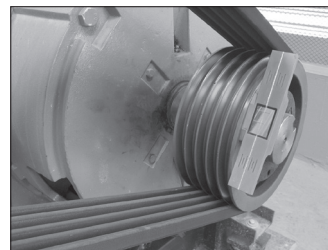

Using EZ Align® laser alignment tool showing laser line on target

If using a straight edge (or string), line the straight edge along the outside face of both sheaves or sprockets as shown in the photo. If the drive is properly aligned, the straight edge or string will contact each sheave or sprocket evenly. The straight edge or string (pulled tight) should touch the two outer edges of each sheave or pulley for a total of four points of contact. Misalignment of sprockets and shafts will show up as a gap between the outside face of the sheave or sprocket and the straight edge. Check for tilting or shaft misalignment by using a bubble level. For proper alignment, the bubble should be in the same position as measured on each shaft.

DRIVE SHUTDOWN & THOROUGH INSPECTION

If using the Gates EZ Align® laser alignment tool, follow the detailed instructions included with the tool. The EZ Align laser alignment tool makes it very quick and easy to check alignment of shafts, sheaves and sprockets. EZ Align is available with a red laser, or a green laser for outdoor or brighter environment use.

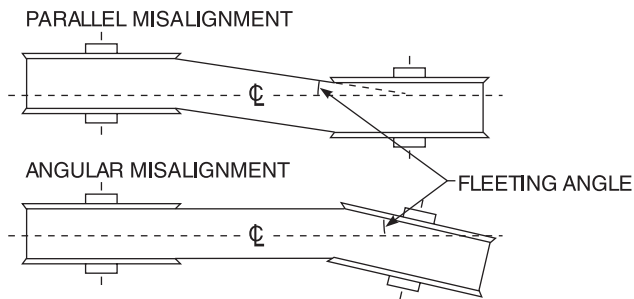

There are three possible causes and solutions of sheave or sprocket misalignment:

1. Angular Misalignment: The motor shafts and driven machine shafts are not parallel.
 - a. Correct alignment by adjusting the motor shaft into alignment with the driveN shaft.
2. Parallel Misalignment: Sheaves or sprockets are not properly located on the shafts.
 - a. Loosen and reposition one or both sheaves or sprockets until properly aligned.
3. Sheaves or sprockets are tilted on the shaft due to incorrect bushing installation.
 - a. Rotate drive by hand and look for excessive wobble. Beware of pinch points. Keep hands and fingers clear, especially where belts enter sheaves and sprockets. If wobble is observed, remove and reinstall sheave or sprocket. Follow the bushing installation procedures explained in the INSTALLATION section. Further check alignment by using one of the previously mentioned methods.

Misalignment on V-belt drives should be less than 1/2° or 1/10" per foot of center distance. Misalignment for synchronous, Polyflex®, or Micro-V® belts should be less than 1/4° or 1/16" per foot of center distance.

When a synchronous belt drive has been aligned (following the procedure discussed above in the "How to Check Alignment" section), do not continue to adjust alignment in an attempt to make the synchronous belt ride in the center of the sprocket's face width. Synchronous belts, while neutral tracking, will tend to ride in contact with a flange on one side of the sprockets. Synchronous belts on drives that are properly aligned will lightly contact the flanges. Synchronous belts on misaligned drives will ride hard against the flanges and generate additional noise. Attempting to adjust a synchronous belt drive's alignment to force the belt to ride in the center of the sprocket's face width will typically result in misalignment.

Guard Inspection

Check the guard for wear or possible damage. Don't overlook wear on the inside of the guard. Check for any areas that may be contacting the belt. Clean the guard to prevent it from becoming blocked and closed to ventilation. Clean off any grease or oil that may have spilled onto the guard from over-lubricated bearings.

Check Other Drive Components

It is always a good idea to examine bearings for proper lubrication. Check the motor base bolts and adjustment screws to make sure they are not loose. If loose, tighten to the recommended torque value. Make sure that adjustment screws are free of debris, dirt, or rust.

Check Belt Tension

Following the drive component inspection, the final step is to check belt tension. Rotate the drive two or three revolutions by hand and check the belt tension. If necessary, retension the belt and make a final alignment check.

If V-belts are undertensioned, they can slip. Slippage generates heat and will result in cracking and belt failure.

If synchronous belts are undertensioned, they can jump teeth or ratchet. Ratcheting will damage the belt and result in premature belt failure.

If belts are overtensioned, belt and bearing life can be reduced.

The proper way to check belt tension is to use a tension tester. Gates has a variety of tension testers, ranging from the simple spring scale type tester to the sophisticated Sonic Tension Meter.

DRIVE SHUTDOWN & THOROUGH INSPECTION

Measuring Belt Tension

The spring scale type tester measures how much force is required to deflect the belt a specified distance at the center of its span. This is the force deflection method of tensioning belts.

The Sonic Tension Meter measures the vibration of the belt span and instantly converts the vibration frequency into belt static tension. This is the span vibration method of tensioning belts.



For more information, refer to the Troubleshooting Tools section.

Force Deflection Tension Method

The force deflection tension method does not directly measure belt span tension or static tension. The deflection force is a calculated value that is based on the amount of static tension required in the belt. Static tension is the tension force that is actually in the belt, while deflection force is simply a measurement to check how much static tension is in the belt. The tension testers used for the force deflection tension method are available in one, two, or five barrel configurations. The one barrel tension tester can measure up to 30 lb. of force; the two barrel tension tester can measure up to 66 lb. of force; and the five barrel tension tester can measure up to 165 lb. of force. Add the force readings from each barrel to determine the total force being measured.

1. Measure span length (t). Span length is the distance from where the belt exits one pulley to where it enters the next pulley.

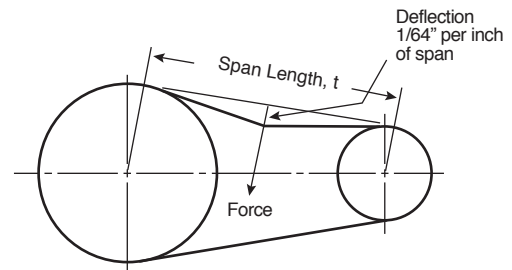

2. Position the lower of the two O-Rings using either of these methods:
 - a. On the scale reading "Deflection Inches", set the O-Ring to show a deflection equal to $1/64$ " per inch of span length (t).
 - b. On the scale reading "Inches of Span Length", set O-Ring to show a deflection equal to the inches of measured span length (t).
3. At the center of the span (t), apply force using the appropriately sized Gates tension testers. Apply the force perpendicular to the span. If the belt is a wide synchronous belt or a PowerBand belt, place a piece of steel or angle iron across the belt width and deflect the entire width of the belt evenly. Deflect the belt until the bottom edge of the lower O-Ring is at the correct deflection distance. If multiple individual V-belts are used on the drive, the deflection distance can be measured against an adjacent belt. For drives with only one belt, use a straightedge or string pulled tight across the sheaves, sprockets, or top of the belt to establish a reference line. When the belt is deflected to measure tension, measure the deflection distance by measuring from the belt to the straight edge or string reference line.

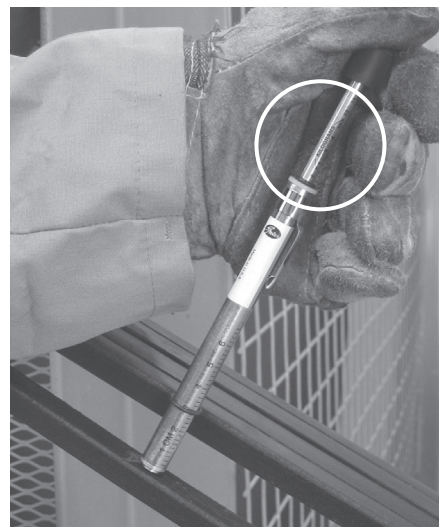

DRIVE SHUTDOWN & THOROUGH INSPECTION

- Find the amount of deflection force on the upper scale of the tension tester. The sliding rubber O-Ring slides up the scale as the tool compresses and stays up for a reading of the deflection force. Read at the bottom edge of the ring. Remember to slide the O-Ring down before using again.
- Installation tension forces should ideally be calculated for each specific drive. The tension calculations are included in all Gates drive design manuals. Additionally, the Gates drive design and selection computer program, Design Flex® Pro™ can be used to quickly calculate the proper installation tensions. Design Flex® Pro™ and Design Flex Web® are available at www.gates.com/drivedesign.

If installation tension values for a specific V-belt drive are not available, the tables shown can be used to determine generic tension values based on the V-belt cross section. As synchronous belt drives are more sensitive to proper belt tensioning, there are no similar quick reference tension tables for them.

Compare the deflection force with the range of forces recommended. If less than the minimum recommended deflection force, the belts are too loose and should be tightened. If more than the maximum recommended deflection force, the belts are too tight and should be loosened.

Recommended Deflection Force Per Belt For Hi-Power® II V-Belts, Hi-Power II PowerBand Belts or Tri-Power® Molded Notch V-Belts							
V-Belt Cross Section	Small Sheave Diameter (in)	Small Sheave RPM Range	Speed Ratio Range	Recommended Deflection Force (Lbs.)			
				Hi-Power® II		Tri-Power Molded Notch	
				Min.	Max.	Min.	Max.
A AX	3.0	1750 to 3600	2.00 to 4.00	2.7	3.8	3.8	5.4
	3.2			2.9	4.2	3.9	5.6
	3.4 - 3.6			3.3	4.8	4.1	5.9
	3.8 - 4.2			3.8	5.5	4.3	6.3
B BX	4.6	1160 to 1800	2.00 to 4.00	5.1	7.4	7.1	10.0
	5.0 - 5.2			5.8	8.5	7.3	11.0
	5.4 - 5.6			6.2	9.1	7.4	11.0
	6.0 - 6.8			7.1	10.	7.7	11.0
C CX	7.4 - 9.4	870 to 1800	2.00 to 4.00	8.1	12.0	7.9	12.0
	7.0			9.1	13.0	12.0	18.0
	7.5			9.7	14.0	12.0	18.0
	8.0 - 8.5			11.0	16.0	13.0	18.0
D	9.0 - 10.5	690 to 1200	2.00 to 4.00	12.0	18.0	13.0	18.0
	11.0 - 16.0			14.0	21.0	13.0	18.0
	12.0 - 13.0			19.0	27.0		
	13.5 - 15.5			21.0	30.0		
D	16.0 - 20.0			24.0	36.0		

Recommended Deflection Force Per Belt For Super HC® V-Belts, Super HC® PowerBand® Belts Super HC® Molded Notch V-Belts or Super HC® Molded Notch PowerBand® Belts					
V-Belt Cross Section	Small Sheave Diameter (in)	Small Sheave RPM Range	Speed Ratio Range	Recommended Deflection Force (Lbs.)	
				Minimum	Maximum
3V	2.65 - 2.80	1200-3600	2.00 to 4.00	3.0	4.3
	3.00 - 3.15	1200-3600		3.3	4.8
	3.35 - 3.65	1200-3600		3.7	5.4
	4.12 - 5.00	900-3600		4.4	6.4
	5.30 - 6.90	900-3600		4.8	7.1
3VX	2.20	1200-3600	2.00 to 4.00	2.8	4.1
	2.35 - 2.50	1200-3600		3.2	4.7
	2.65 - 2.80	1200-3600		3.5	5.1
	3.00 - 3.15	1200-3600		3.8	5.5
	3.35 - 3.65	1200-3600		4.1	6.0
	4.12 - 5.00	900-3600		4.8	7.1
5VX	5.30 - 6.90	900-3600	2.00 to 4.00	5.8	8.6
	4.40 - 4.65	1200-3600		9.0	13.0
	4.90 - 5.50	1200-3600		10.0	15.0
	5.90 - 6.70	1200-3600		11.0	17.0
	7.10 - 8.00	600-1800		13.0	19.0
	8.50 - 10.90	600-1800		14.0	20.0
5V	11.80 - 16.00	400-1200	2.00 to 4.00	15.0	23.0
	7.10 - 8.00	600-1800		11.0	16.0
	8.50 - 10.90	600-1800		13.0	18.0
8V	11.80 - 16.00	400-1200	2.00 to 4.00	14.0	21.0
	12.50 - 17.00	600-1200		28.0	41.0
	18.00 - 24.00	400-900		32.0	48.0

DRIVE SHUTDOWN & THOROUGH INSPECTION

Recommended Deflection Force Per Belt For Metric-Power V-Belts						
V-Belt Cross Section	Small Sheave Diameter (in)		Small Sheave RPM Range	Speed Ratio Range	Recommended Deflection Force (Lbs.)	
					Minimum	Maximum
SPZ	2.20	2.64	1200-3600	2.00 to 4.00	3.2	4.5
		2.80	1200-3600		3.6	5.0
	2.95	3.15	1200-3600		4.1	5.9
	3.35	3.74	1200-3600		4.5	6.8
	3.94	4.92	900-3600		5.4	7.7
	5.20	7.09	900-3600	5.9	8.6	
SPA	3.15	3.74	1200-3600	2.00 to 4.00	5.4	7.3
	3.94	4.92	900-3600		6.4	9.5
	5.20	7.87	600-1800		8.6	12.7
	8.35	9.84	600-1800		9.1	13.6
SPB	4.41	5.91	1200-3600	2.00 to 4.00	10.4	16.3
	6.30	7.87	600-1800		13.2	20.0
	8.35	11.02	600-1800		16.3	22.7
	11.81	15.75	400-1200		17.2	26.3
SPC	7.09	9.29	600-1800	2.00 to 4.00	18.1	27.2
	9.84	13.98	400-1200		23.1	34.0
	14.76	20.87	400-900		27.2	40.8
XPZ		2.20	1200-3600	2.00 to 4.00	3.2	5.0
	2.36	2.48	1200-3600		3.6	5.9
	2.64	2.80	1200-3600		4.1	6.4
	2.95	3.15	1200-3600		4.5	6.8
	3.35	3.74	1200-3600		5.0	7.3
	3.94	4.92	900-3600		5.9	8.6
XPA	3.15	4.92	900-3600	2.00 to 4.00	8.2	12.2
	5.20	7.87	900-3600		10.0	14.1
XPB	4.41	4.65	1200-3600	2.00 to 4.00	10.9	16.3
	4.92	5.51	1200-3600		12.2	18.6
	5.91	6.69	1200-3600		13.6	21.3
	7.09	7.87	600-1800		16.3	24.0
	8.35	11.02	600-1800		17.2	24.9
	11.81	15.75	400-1200		18.6	29.0
XPC	7.09	9.29	600-1800	2.00 to 4.00	22.7	34.0
	9.84	13.98	400-1200		29.5	43.1
	14.76	20.87	400-900		36.3	49.9
10X		2.20	1200-3600	2.00 to 4.00	2.8	4.1
	2.35	2.50	1200-3600		3.2	4.7
	2.65	2.80	1200-3600		3.5	5.1
	3.00	3.15	1200-3600		3.8	5.5
	3.35	3.65	1200-3600		4.1	6.0
	4.12	5.00	900-3600		4.8	7.1
13X		3.00	1750 to 3600	2.00 to 4.00	3.8	5.4
		3.20			3.9	5.6
	3.40	3.60			4.1	5.9
	3.80	4.20			4.3	6.3
	4.60	7.00			4.9	7.1
17X		4.60	1160 to 1800	2.00 to 4.00	7.1	10.0
	5.00	5.20			7.3	11.0
	5.40	5.60			7.4	11.0
	6.00	6.80			7.7	11.0
	7.40	9.40			7.9	12.0

Span Vibration Method

The Gates Sonic Tension Meter can be used with all Gates belts. The Sonic Tension Meter measures the vibration in the belt span, and converts that measurement into a reading of the actual static tension in the belt. To use the Sonic Tension Meter, you will need to enter the belt unit weight, belt width for synchronous belts or number of ribs or strands for V-belts, and the span length. To measure the span vibration, press the "Measure" key on the meter, tap the belt span to vibrate the belt, and hold the microphone approximately 3/8" to 1/2" away from the back of the belt. The Sonic Tension Meter will display the static tension, and can also display the vibration frequency.

Since the span vibration method is intended to be a very accurate method of measuring actual tension in a belt, it is important that the proper recommended tension is calculated for the specific belt drive. Procedures for calculating belt tension are included in each of the appropriate Gates drive design manuals. To determine the belt tension recommended for specific drive applications, refer to the appropriate belt drive design manual, download the Gates belt drive selection program DesignFlex® Pro™ at www.gates.com/drivedesign, or download the PT Toolkit mobile app at www.gates.com/pttoolkit. Alternatively, Gates Power Transmission Product Application engineers can be contacted at ptpasupport@gates.com or (303) 744-5800.

On-the-go belt tensioning information is available in our PT Toolkit mobile app. Download today.



DRIVE SHUTDOWN & THOROUGH INSPECTION

The adjusted belt weights for use with the Gates Sonic Tension Meter are shown in the following table.

Belt Product Family	Belt Cross Section	Belt Type	Adjusted Belt Weight (grams/meter)
Super HC® V-Belts	3VX	Single	53
	5VX	Single	140
	8VX	Single	383
	3V	Single	72
	5V	Single	200
	8V	Single	510
	3VX	PowerBand®	65
	5VX	PowerBand®	157
	3V	PowerBand®	96
	5V	PowerBand®	241
Super HC® XPT™ V-Belts	5VXP	Single	163
	5VXP	PowerBand®	
Predator® V-Belts	5VP	Single	217
	8VP	Single	528
	AP	Single	114
	BP	Single	174
	CP	Single	323
	SPBP	Single	208
	SBCP	Single	375
	3VP	PowerBand®	89
	5VP	PowerBand®	217
	8VP	PowerBand®	528
	BP	PowerBand®	212
	CP	PowerBand®	332
Tri-Power® V-Belts	AX	Single	79
	BX	Single	136
	CX	Single	216
	AX	PowerBand®	100
	BX	PowerBand®	163
	CX	PowerBand®	281
Hi Power® II V-Belts	A	Single	95
	B	Single	168
	C	Single	275
	D	Single	553
	E	Single	965
	A	PowerBand®	151
	B	PowerBand®	200
	C	PowerBand®	342
Hi Power® II Dubl-V Belts	AA	Single	125
	BB	Single	194
	CC	Single	354
	DD	Single	750
Micro-V® Belts	H	Single	5.3
	J	Single	7.0
	K	Single	18
	L	Single	29
	M	Single	109
Metric Power™ V-Belts Lengths ≤ 3000mm	XPZ	Single	51
	XPA	Single	87
	XPB	Single	156
	XPC	Single	249
	10X	Single	44
	13X	Single	82
	17X	Single	138

DRIVE SHUTDOWN & THOROUGH INSPECTION

Belt Product Family	Belt Cross Section	Belt Type	Adjusted Belt Weight (grams/meter)
Metric Power™ V-Belts Lengths ≤ 3000mm	SPZ	Single	72
	SPA	Single	115
	SPB	Single	186
	SPC	Single	337
	13X	Single	77
Truflex® V-Belts	17X	Single	138
	2L	Single	19
	3L	Single	38
	4L	Single	66
PoweRated® V-Belts	5L	Single	108
	3L	Single	45
	4L	Single	71
Polyflex® V-Belts	5L	Single	119
	3M	Single	3.5
	5M	Single	9.9
	7M	Single	24
	11M	Single	49
	3M	JB®	5.2
	5M	JB®	11
PowerGrip® Timing Belts	7M	JB®	30
	11M	JB®	64
	MXL	Synchronous	1.3
	XL	Synchronous	2.4
	L	Synchronous	3.2
PowerGrip® Timing Twin Power® Belts	H	Synchronous	3.9
	XH	Synchronous	11.3
	XXH	Synchronous	14.9
PowerGrip® HTD® Belts	XL	Synchronous	1.9
	L	Synchronous	3.2
	H	Synchronous	4.6
	3M	Synchronous	2.4
	5M	Synchronous	3.9
PowerGrip® HTD® Twin Power® Belts	8M	Synchronous	6.2
	14M	Synchronous	9.9
	20M	Synchronous	12.8
	3M	Synchronous	2.7
PowerGrip® GT®2 Belts	5M	Synchronous	4.6
	8M	Synchronous	7.2
	14M	Synchronous	12.3
	2M	Synchronous	1.4
PowerGrip® GT®2 Twin Power® Belts	3M	Synchronous	2.8
	5M	Synchronous	4.1
	8M	Synchronous	5.5
	14M	Synchronous	9.6
PowerGrip® GT®3 Belts	3M	Synchronous	2.8
	5M	Synchronous	4.1
	8M	Synchronous	5.8
	14M	Synchronous	9.7
Poly Chain® GT®2, Poly Chain® GT® Carbon™ and Poly Chain® Carbon™ Volt™ Belts	5M	Synchronous	3.0
	8M	Synchronous	4.7
	14M	Synchronous	7.9
	19M	Synchronous	10.5



INSTALLATION

How to Install Belts

When a belt is being installed, the same basic steps must be followed, regardless of whether the belt is a V-belt or a synchronous belt.

Preparation

1. Confirm that the power is off, locked, and tagged. Never work on a belt drive until this important step is completed. Wear proper safety equipment (hardhat, gloves, safety glasses, steel toe shoes).
2. Remove belt guard and place away from drive so that it does not interfere with working on the drive.

Removal

3. Loosen motor mounting bolts or adjusting screws.

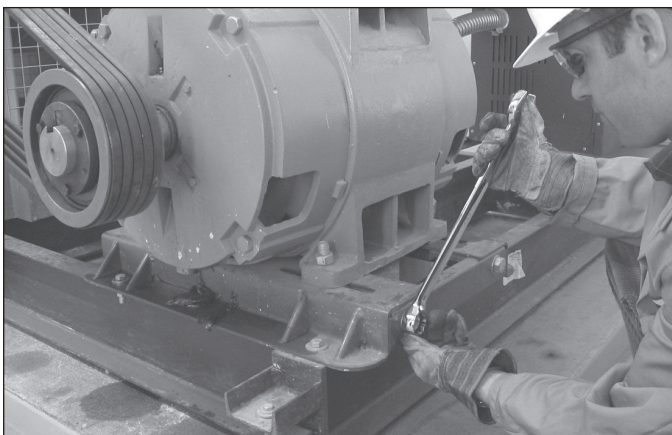

4. Move the motor in until the belt is slack and can be removed easily without prying. Never pry off a belt, as the sheave or sprocket can be damaged. Prying off belts also adds the risk of injury.



5. Remove old belt.

Inspection

6. Inspect the old belt for any unusual wear. Excessive or unusual wear may indicate problems with the drive design or past maintenance procedures. Refer to the Problem/Solution Summary Table in the Belt Performance and Troubleshooting section for guidelines in matching belt appearance to possible problem causes.
7. Inspect the sheaves or sprockets for unusual or excessive wear. Belt life will be reduced if the sheaves or sprockets are worn. Wear gloves for protection from nicks or sharp surfaces.

For V-belt sheaves: Inspect grooves for wear and nicks. Use Gates sheave gauges to determine if the grooves are worn. Place the proper sheave gauge into the groove and check for wear. If more than 1/32" of wear can be seen between the gauge and groove side wall, the sheaves are worn and should be replaced. A light source such as a flashlight may be used to backlight the gauge.



Do not be misled by "shiny" grooves. Grooves that are "shiny" are often polished because of heavy wear.

Inspect the sheave grooves for rust or pitting. If rusted or pitted surfaces are found, the sheave should be replaced.

For Synchronous sprockets: Inspect sprocket grooves for unusual or excessive wear. Check for excessive wear by both visually inspecting the grooves and by running your finger along the sprocket grooves. If you can feel or see noticeable wear, the sprockets are worn and should be replaced.

INSTALLATION

Do not be misled by “shiny” grooves. Grooves that are “shiny” are often polished because of heavy wear.

Inspect the sprocket grooves for rust or pitting. If rusted or pitted surfaces are found, the sprocket should be replaced.

Check the sprocket flanges and make sure that they are not loose or bent. Bent flanges can interfere with the belt and cause premature belt wear and failure.

8. If necessary, clean sheave and sprocket grooves by wiping the surface with a rag slightly dampened with a light, non-volatile solvent. Do not sand or scrape the grooves to remove debris.

Installation

9. If necessary, install new sheaves or sprockets. Refer to page 14 for detailed instructions for installing QD or Taper-Lock® bushings.
10. Check the sheave or sprocket alignment. In order to achieve optimum belt life, it is important that the drive's sheaves or sprockets be aligned properly. Use a straightedge or Gates EZ Align® laser alignment tool. Adjust the sheave or sprocket position as necessary.
11. Install the new belt or set of belts.

Replace all belts on multiple V-belt drives. Never replace a single belt or a portion of a multiple belt drive. Always use belts from the same manufacturer on a multiple belt drive. If a new belt is used with old belts, the load will not be shared evenly between the belts on a multiple V-belt drive. Mixing new and old belts very possibly could lead to premature belt failure and uneven sheave wear.

When installing the belt, make sure that there is clearance to slip the belt over the sheave or sprocket. Do not pry or use force to install the belt. Do not roll the belt onto the drive.

12. Adjust the motor base adjustment screws to take up the center distance on the belt drive until the belts are tight.
13. Check belt tension, using a tension gauge or Sonic Tension Meter. Adjust the belt drive's center distance until the correct tension is measured.

On multiple belt drives, some belts may appear to hang unevenly when installed. It is normal for belts within RMA length and matching tolerances to have noticeable differences in the distance the belt span sags. This is called the “catenary effect”.

Catenary effect is a curve made by a cord of uniform weight suspended between two points.

Follow the recommended run-in and retensioning procedure to minimize the visible difference in belt sag.

14. Rotate the belt drive by hand for a few revolutions. Re-check the belt tension and adjust as necessary.
15. Re-check the drive alignment and adjust as necessary.

Completion

16. Secure motor mounting bolts to the correct torque.
17. Re-check the belt tension and adjust as necessary. Tightening the motor mounting bolts may have changed the belt tension.
18. Replace the belt guard.
19. Start the drive, looking and listening for any unusual noise or vibration. If possible, shut down the drive and check the bearings and motor for unusual heat. If the motor or bearings are hot, the belt tension may be too high, or bearings may not be properly lubricated. Temperatures can be checked with an infrared pyrometer.

V-Belt Run-In Procedure

20. A run-in procedure is recommended for all V-belt drives so that the optimum belt life can be achieved. A run-in consists of starting the drive and letting it run under full load for up to 24 hours. If a 24 hour run-in is not possible, let the belt drive run overnight, to the next shift, or at least a few hours. After the belts have run-in, stop the belt drive and check the belt tension. Running the belts under full load for an extended period of time will seat the V-belts into the sheave grooves.

V-belt tension will drop after the initial run-in and seating process. This is normal. Adjust the belt tension as necessary.

Since tension in V-belts will drop after the initial run-in and seating process, failure to check and retension the belt will result in low belt tension and belt slippage. This slippage will result in premature belt failure.



INSTALLATION

How to Install Taper-Lock® and QD® Bushed Sheaves and Sprockets

It is important that new or replacement sheaves or sprockets be properly installed. Most sheaves or sprockets are attached to a shaft with a tapered bushing that fits a mating tapered bore in the sheave or sprocket. Bushings come in several different bore size diameters. This allows for a reduction in the parts inventory required in your plant because one bushing size with multiple bore sizes can be used with a number of different sizes of sheaves or sprockets.

There are two styles of bushings: Taper-Lock® and QD®. Installation and removal instructions for each style are noted below.

Taper-Lock® Type Sprocket Installation and Removal

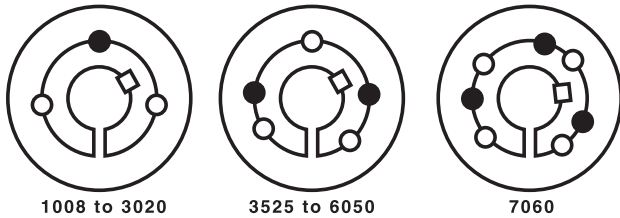

To Install Taper-Lock® Type Hardware

1. Clean the shaft, bushing bore, tapered bushing barrel and the sprocket hub bore of all oil, paint and dirt (*Note: Lubricants are not to be applied to bushings or sprockets*). Remove any burrs with a file or emery cloth.
2. Insert bushing into sprocket hub matching hole patterns, not threaded holes. Tightening holes ("○" in diagram above) will be threaded on the sprocket hub side only. Removal holes ("●" in diagram above) will be threaded on the bushing side only. Thread screws into the installation or "○" holes.
3. LIGHTLY oil the set screws and thread them into the half-threaded holes indicated in the diagram above. (*Note: Do not lubricate the bushing taper, hub taper, bushing bore, or the shaft. Doing so could result in sprocket breakage.*)
4. With the key in the shaft keyway "□", position the assembly onto the shaft at the desired location. Allow for small axial sprocket movement on bushing during tightening. (*Note: When mounting sprockets on vertical shafts, precautions must be taken to prevent the sprocket/bushing from falling during the tightening.*)

5. Alternately torque screws to the recommended torque level specified in the table below. *Note: Using worn hex key wrenches may damage screw heads preventing proper tightening torque and removal.*
6. Check the alignment and sprocket axial runout (wobble), and correct as necessary.

Taper-Lock® Bolt Torque

Bushing Style	Bolts		Torque Wrench	
	Qty.	Size	lb-ft	lb-in
1008	2	1/4-20 x 1/2	4.6	55
1108	2	1/4-20 x 1/2	4.6	55
1210	2	3/8-16 x 5/8	14.6	175
1610	2	3/8-16 x 5/8	14.6	175
2012	2	7/16-14 x 7/8	23.3	280
2517	2	1/2-13 x 1	35.8	430
3020	2	5/8-11 x 1 1/4	66.7	800
3525	3	1/2-13 x 1 1/2	83.3	1000
4030	3	5/8-11 x 1 3/4	141.7	1700
4535	3	3/4-10 x 2	204.2	2450
5040	3	7/8-9 x 2 1/4	258.3	3100
6050	3	1 1/4-7 x 3 1/2	651.7	7820
7060	4	1 1/4-7 x 3 1/2	651.7	7820

7. To increase and ensure bushing gripping force, firmly tap the bushing face using a drift or punch (*do not hit bushing face directly with hammer*), then re-torque screws to the recommended torque level.

Note: Do not continue tightening screws further after target torque has been reached as bushing over insertion and hub fracture may occur.
8. Recheck all screw torque values after the initial drive run-in, and periodically thereafter. Repeat steps 5 through 7 if loose.

To Remove TL Type Hardware

1. Release belt tension and lift belt off of sprockets (*Note: Do not pry or roll belts off*).
2. Loosen and remove screws securing sprockets to bushings.
3. Insert screws into removal holes ("●").
4. Alternately tighten screw or screws in small but equal increments until sprockets disengage from bushings.
5. Remove sprockets and bushings from shafts as necessary.

INSTALLATION

QD Type Hardware Installation and Removal

To Install QD Type Hardware

- Clean the shaft, bushing bore, tapered bushing barrel and the sheave hub bore of all oil, paint and dirt (*Note: Lubricants are not to be applied to bushings or sheaves*). Remove any burrs with a file or emery cloth.
- Determine the type of mounting that will be used:

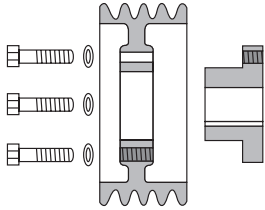

Conventional Mounting

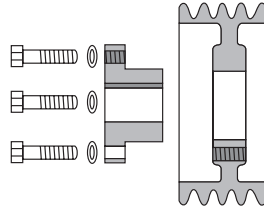

Reverse Mounting

- Conventional Mounting:
 - Insert key into the shaft keyway (*Note: If key is furnished with bushing, it is special and must be used*).
 - Insert a screw driver blade (or similar) into the bushing flange saw cut to enlarge bore slightly (*Caution: Excessive enlargement can split bushing*).
 - Slide bushing onto shaft with the flange side towards the equipment. Position bushing and tighten set screw to prevent sliding on shaft.
 - Place sheave onto bushing and insert cap screws. Align drilled holes in sheave hub with tapped holes in bushing flange. (*Note: Install M thru S bushings so that the two tapped removal holes in sheave hubs are located far away from bushing saw cuts*). Finger-tighten the screws.
- Reverse Mounting:
 - Insert key into the shaft keyway (*Note: If key is furnished with bushing, it is special and must be used*).
 - Place sheave onto shaft without bushing.
 - Insert a screw driver blade (or similar) into the bushing flange saw cut to enlarge bore slightly (*Caution: Excessive enlargement can split bushing*).
 - Slide bushing onto shaft with flange facing outward, away from equipment. Position bushing and tighten the set screw enough to prevent sliding on shaft.
 - Place sheave onto the bushing and insert cap screws. Align drilled holes in bushing flange with

tapped holes in sheave hub (*Note: Install M thru S bushings so that the two tapped removal holes in sheave hubs are located far away from bushing saw cuts*). Finger-tighten the screws.

- When positioned to the desired location, secure the first sheave/bushing assembly to the shaft by tightening the bushing cap screws. Allow for small axial sheave movement on bushing during tightening. Using a torque wrench, tighten the cap screws evenly in an alternating pattern until the recommended torque level in the following table is reached. (*Note: When mounting sprockets on vertical shafts, precautions must be taken to prevent the sheave/bushing from falling during the tightening*).

Note: Do not continue tightening cap screws further after target torque has been reached as bushing over insertion and hub fracture may occur. The gap between the bushing flange and sheave hub is intentional and necessary.

QD Bolt Torque

Bushing Style	Bolts		Torque Wrench	
	Qty.	Size	lb-ft	lb-in
H	2	1/4 x 3/4	7.9	95
JA	3	10-24 x 1	4.5	54
SH & SDS	3	1/4-20 x 1 3/8	9.0	108
SD	3	1/4-20 x 1 7/8	9.0	108
SK	3	5/16-18 x 2	15.0	180
SF	3	3/8-16 x 2	30.0	360
E	3	1/2-13 x 2 3/4	60.0	720
F	3	9/16-12 x 3 5/8	75.0	900
J	3	5/8-11 x 4 1/2	135.0	1620
M	4	3/4-10 x 6 3/4	225.0	2700
N	4	7/8-9 x 8	300.0	3600
W	4	1 1/8-7 x 11 1/2	600.0	7200
S	5	1 1/4-7 x 15 1/2	750.0	9000
P	4	1-8 x 9 1/2	450.0	5400

To Remove QD Type Hardware

- Release belt tension and lift belts off of sheaves (*Note: Do not pry or roll belts off*).
- Loosen and remove cap screws securing sheaves to bushings. If applicable, loosen keyway set screws.
- Insert cap screws into the tapped removal holes adjacent the drilled holes.
- Alternately tighten cap screws in small but equal increments until sheaves disengage from bushings. (*Note: Uneven or excessive pressure on cap screws can break bushing flanges making removal extremely difficult*)
- Remove sheaves and bushings from shafts as necessary.



BELT STORAGE AND HANDLING

Storage Recommendations

Proper preventive maintenance should not be limited to the actual belt drive operating on equipment, but should also include following proper storage procedures. In order to retain their serviceability and dimensions, proper storage procedures must be followed for all belt types. Quite often premature belt failures can be traced to improper belt storage procedures that damaged the belt before it was installed on the drive. By following a few common sense steps, these types of belt failures can be avoided.

General Guidelines

Recommended

Belts should be stored in a cool and dry environment with no direct sunlight. Ideally, less than 85° F and 70% relative humidity.

Store on shelves or in boxes or containers. If the belt is packaged in a box, like Poly Chain® GT® Carbon™ belts, store the belt in its individual box.

V-belts may be stored by hanging on a wall rack if they are hung on a saddle or diameter at least as large as the minimum diameter sheave recommended for the belt cross section.

When the belts are stored, they must not be bent to diameters smaller than the minimum recommended sheave or sprocket diameter for that cross section. (see Technical Information section) Belts should not be stored with back bends that are less than 1.3 times the minimum recommended sheave or sprocket diameter for that cross section.

If stored in containers, make sure that the belt is not distorted when in the container. Limit the contents in a container so that the belts at the bottom of the container are not damaged by the weight of the rest of the belts in the container.

Not Recommended

Belts should not be stored near windows, which may expose the belts to direct sunlight or moisture.

Belts should not be stored near heaters, radiators, or in the direct airflow of heating devices.

Belts should not be stored near any devices that generate ozone. Ozone generating devices include transformers and electric motors.

Belts should not be stored where they are exposed to solvents or chemicals in the atmosphere.

Do not store belts on the floor unless they are in a protective container. Floor locations are exposed to traffic that may damage the belts.

Do not crimp belts during handling or while stored.

Belts are crimped by bending them to a diameter smaller than the minimum recommended diameter sheave or sprocket for that cross section. Do not use ties or tape to pull belt spans tightly together near the “end” of the belt. This will crimp the belt and cause premature belt failure. Do not hang on a small diameter pin that suspends all of the belt weight and bends the belt to a diameter smaller than the minimum recommended sheave or sprocket diameter. Improper storage will damage the tensile cord and the belt will fail prematurely. Handle belts carefully when removing from storage and going to the application. Do not inadvertently crimp or damage the belts by careless handling.

Storage Methods

V-Belts

V-belts can be coiled in loops for storage purposes. Each coil results in a number of loops. One coil results in three loops, two coils results in five loops, etc. The maximum number of coils that can be used depends on the belt length. If coiling a belt for storage, consult the table on the next page and follow the limits shown.

BELT STORAGE AND HANDLING

Belt Cross Section	Belt Length (in)	Belt Length (mm)	Number of Coils	Number of Loops
3L, 4L, 5L, A, AX, AA, B, BX, 3V, 3VX, 9R, 13R, 13C, 13CX, 13D, 16R, 16C, 16CX, 9N	Under 60	Under 1500	0	1
	60 up to 120	1500 up to 3000	1	3
	120 up to 180	3000 up to 4600	2	5
	180 and over	4600 and over	3	7
BB, C, CX, 5V, 5VX, 16D, 22C, 22CX, 15N	Under 75	Under 1900	0	1
	75 up to 144	1900 up to 3700	1	3
	144 up to 240	3700 up to 6000	2	5
	240 and over	6000 and over	3	7
CC, D, 22D, 32C	Under 120	Under 3000	0	1
	120 up to 240	3000 up to 6100	1	3
	240 up to 330	6100 up to 8400	2	5
	330 up to 420	8400 up to 10,600	3	7
	420 and over	10,600 and over	4	9
8V, 8VX, 25N	Under 180	Under 4600	0	1
	180 up to 270	4600 up to 6900	1	3
	270 up to 390	6900 up to 9900	2	5
	390 up to 480	9900 up to 12,200	3	7
	Over 480	12,200 and over	4	9

PowerBand® V-Belts, Synchronous Belts, Micro-V® Belts

Poly Chain® GT® Carbon™ belts are shipped in individual boxes. Poly Chain® GT® Carbon™ belts should be stored in the box in which it was shipped.

These belts may be stored by hanging on a wall rack if they are hung on a saddle or diameter at least as large as the minimum diameter sheave or sprocket recommended for the belt cross section, and the belts are not distorted.

PowerBand® V-belts, Synchronous belts, and Micro-V® belts up to 120 inches (3000 mm) may be stored in a nested configuration. Nests are formed by laying a belt on its side on a flat surface and placing as many belts inside the first belt as possible without undue force. When nests are formed, do not bend the belts to a diameter that is smaller than the minimum recommended sheave or sprocket diameter. Nests may be stacked without damaging the belts if they are tight and stacked with each nest rotated 180° from the nest below.

PowerBand® V-belts and Micro-V® belts over 120 inches (3000 mm) may be rolled up and tied for shipment. These individual rolls may be stacked for easy storage. When the belts are rolled, they must not be bent to a diameter that is smaller than the minimum diameter recommended for the cross section.

Variable Speed V-Belts

Variable speed belts have a thicker cross section and are more sensitive to distortion than other V-belts. Do not hang variable speed belts from pins, racks, or saddles. Store variable speed belts on their edge on shelves. Variable speed belts that are in sleeves may be stacked, taking care to avoid distorting the belts at the bottom of the stack.

Storage Effects

In order to retain their serviceability and dimensions, proper storage procedures must be followed for all belt types. Quite often premature belt failures can be traced to improper belt storage procedures that damaged the belt before it was installed on the drive.

Belts may be stored up to six years if properly stored at temperatures less than 85°F and relative humidity less than 70%.

If the storage temperature is higher than 85°F, the storage limit for normal service performance is reduced by one half for each 15°F increase in temperature. Belts should never be stored at temperatures above 115°F.

At relative humidity levels above 70%, fungus or mildew may form on stored belts. This has minimal affect on belt performance, but should be avoided.

When equipment is stored for prolonged periods of time (over six months), the belt tension should be relaxed so that the belt does not take a set, and the storage environment should meet the 85°F and 70% or less relative humidity condition. If this is not possible, belts should be removed and stored separately in a proper environment.



BELT IDENTIFICATION

When preventive maintenance inspections indicate that belts need replacing, it is important to install the correct belts.

Consequently, it is important to identify the various types and sizes of belts available, and then quickly be able to specify the correct replacement.

The information on the following pages will help identify the belt types used in industry. Gates makes a belt to fit nearly any application.

V-Belts

Super HC® V-Belts

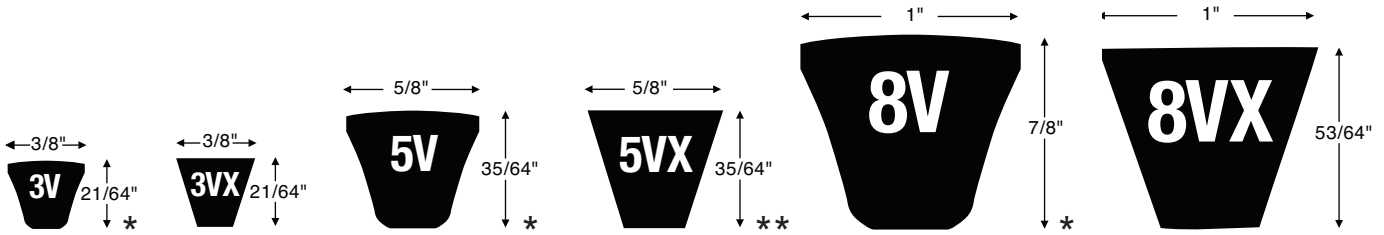

Hi-Power® II V-Belts

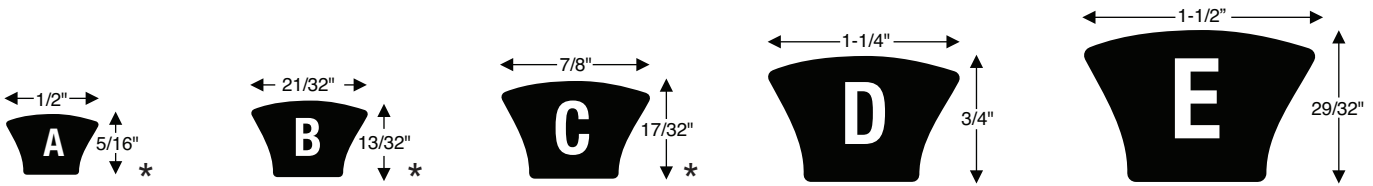

Tri-Power® V-Belts

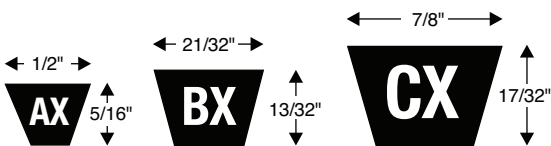

PowerBand® – Hi-Power® II, Super HC®, Tri-Power®, Predator® and XP™



Metric Power™ V-Belts

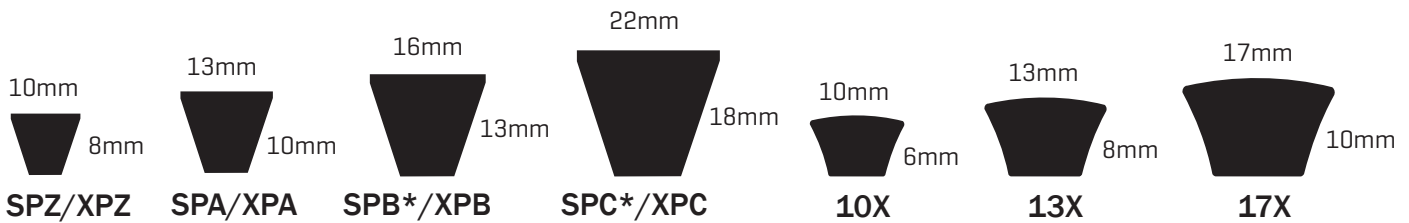

*Also available in Predator® belt construction.

**Also available in XP™ belt construction.

BELT IDENTIFICATION

Multi-Speed Belts Top Width-Sheave Angle

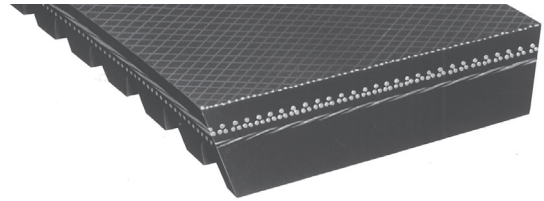

Example: Belt No. 2326V310 designates:

23	:	26	:	V	:	310
Top Width in 16ths of an Inch: $23/16" = 1-7/16"$:	Sheave Angle in Degrees (26)	:	Multi-Speed	:	Pitch Circumference to the Nearest 10th Inch: 31.0"

Truflex® (Light Duty) V-Belts

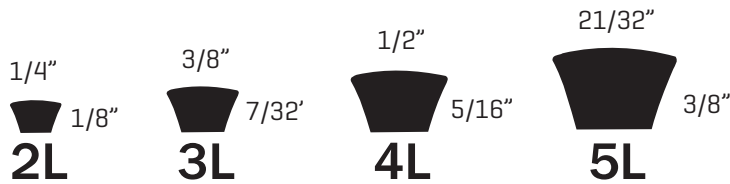

PowerRated® V-Belts

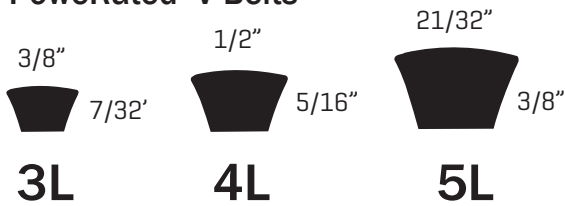

Dubl-V Belts

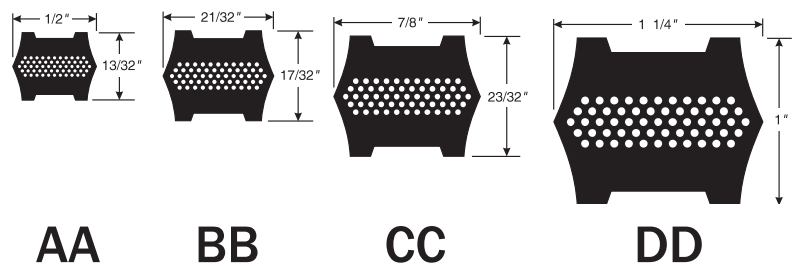

Micro-V® Belts



Standard Polyflex® V-Belts

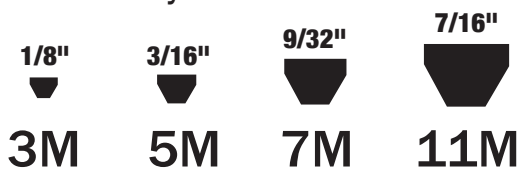

Polyflex® JB® V-Belts



BELT IDENTIFICATION

Synchronous Belts

All synchronous belts are identified in a similar manner, in either English or metric units. Belts are measured by:

1. Pitch: Distance in inches or millimeters between two adjacent tooth centers as measured on the belt pitch line.

2. Pitch Length: Total length (circumference) in inches or millimeters as measured along the pitch line. It is equal to the pitch multiplied by the number of teeth in the belt.

3. Width: Denoted in inches or millimeters.

Poly Chain® GT® Carbon™ Belts

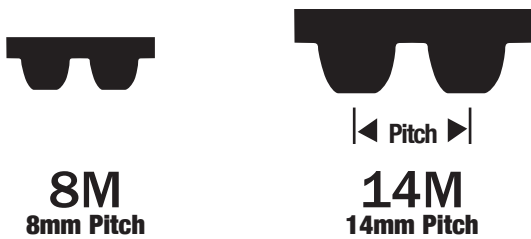

Also available in static conductive Poly Chain Carbon Volt™ construction

PowerGrip® HTD® Belts

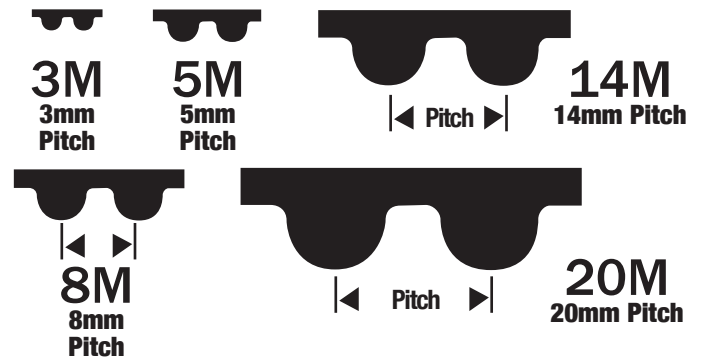

PowerGrip® GT®3 Belts

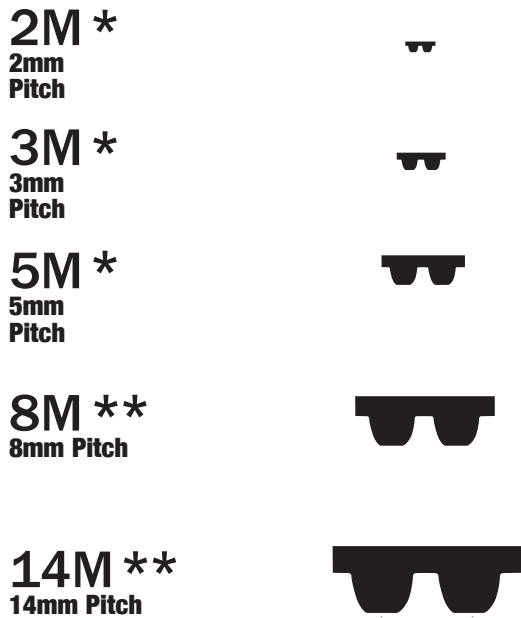

PowerGrip® Timing Belts

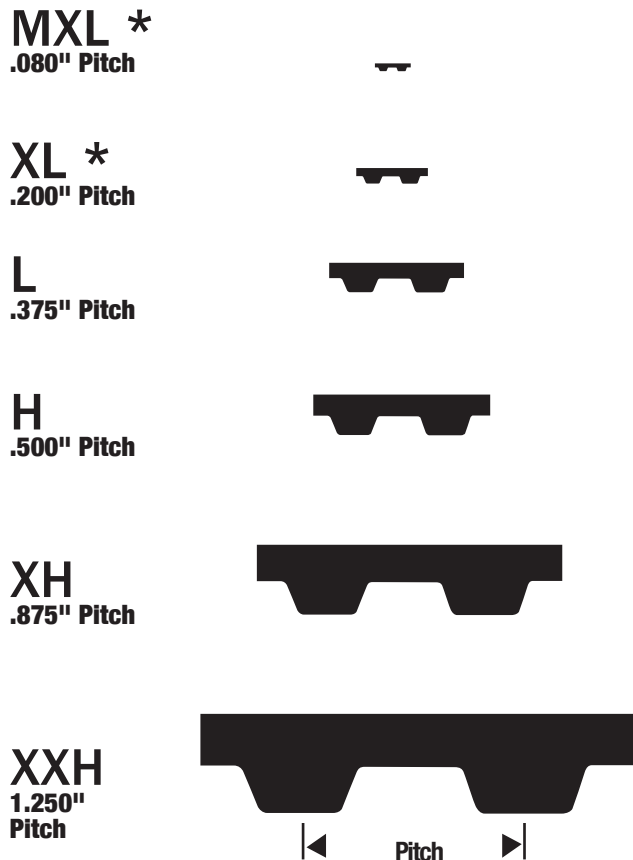

*Also available in TruMotion® belt construction

**Static conductive to ISO 9563 industry standard

BELT IDENTIFICATION

Twin Power® Timing Belts

XL
.200" Pitch



L
.375" Pitch



H
.500" Pitch



Twin Power® PowerGrip® GT®2 Belts

3M
3mm Pitch



5M
5mm Pitch



8M
8mm Pitch



14M
14mm Pitch

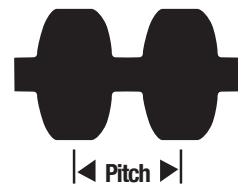

BELT IDENTIFICATION

Synchro-Power® Polyurethane Belts

T5
5mm Pitch



T10
10mm Pitch



T20
20mm Pitch



AT5
5mm Pitch



AT10
10mm Pitch



AT20
20mm Pitch



5M HTD
5mm Pitch



8M HTD
8mm Pitch



14M HTD
14mm Pitch



BELT TYPES

Narrow Section V-Belts

These high capacity belts are used to substantially reduce drive costs and decrease space requirements. This V-belt handles the complete range of drive horsepower recommended with three narrow cross sections instead of the five regular cross sections needed for classical heavy-duty belts. Specified by 3V, 5V or 8V cross sections. Specify Gates Super HC® V-belts.

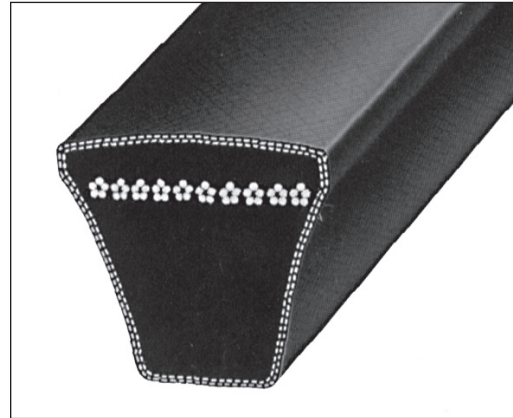

Classical Section V-Belts

These are the original belts used in heavy duty applications. They are specified by cross section and standard length. The size is designated as A, B, C, D or E. The easiest way to select a replacement is by finding the belt number on the worn belt. If not legible, measure the belts outside circumference with a flexible tape, preferably while it is still on the drive.

Then, order the Gates **Hi-Power® II** V-belt which has the next shorter standard length. For example: For an "A" section belt with a 28.0" O.C., order an A26 replacement belt.

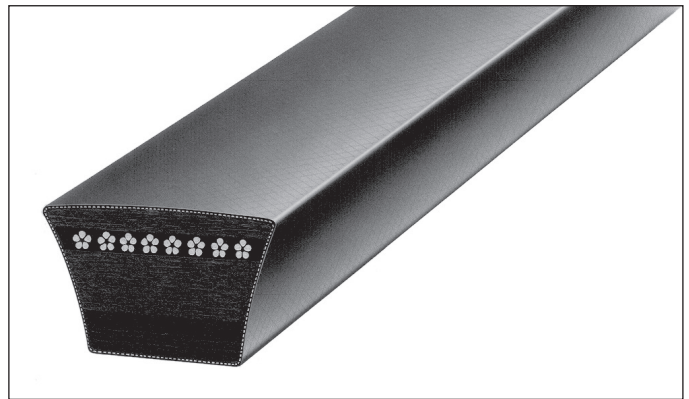

Banded and Bandless Belts

Banded belts, also called wrapped or covered belts, have a fabric cover. Un-notched and generally with concave sidewalls, banded belts have rounded bottom corners and arched tops.

Bandless belts have no fabric cover, straight cut-edge sidewalls, and special molded notches. The notches reduce bending stress which allows belts to run on smaller diameter sheaves than comparable non-notched banded belts.

Gates offers these two types in both the classical and narrow sections. In the classical section, Gates **Tri-Power®** molded notch is available in AX, BX and CX cross sections. Its length is specified by the same standard belt number as other classical section belts.

Gates also offers **Super HC® Molded Notch** V-belts in 3VX, 5VX and 8VX sizes.

In both cases, an "X" is used in the belt number to designate a molded notch construction. For example: An AX26 is a bandless, molded notch classical section belt. A 5VX1400 is a narrow section, bandless, molded notch belt with a 140" O.C.

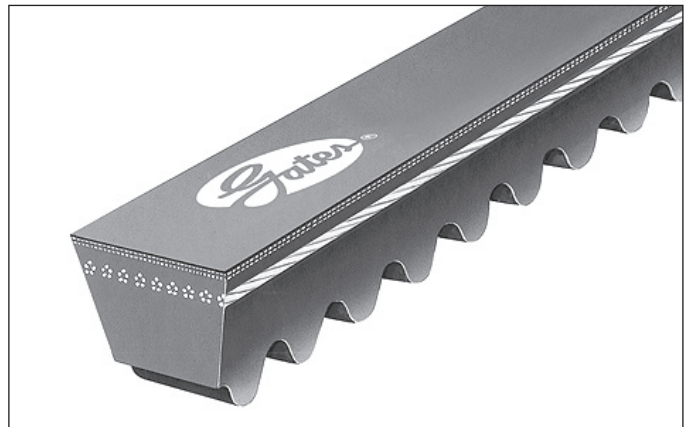

Note: The revolutionary Gates belt construction is used in the notched belts.



BELT TYPES

Light Duty Belts

These are used on light duty fractional horsepower drives and are designed for use with backside idlers. **Gates Truflex®** and **PowerRated®** V-belts are offered in this category and are specified by cross section and outside circumference. **Truflex®** is recommended for the lower lighter duty range. **PowerRated®**, a special belt designed for clutching, heavier shock-load and backside idler drives, is recognized by its green color. Reinforced with an aramid fiber tensile (pound for pound stronger than steel). **PowerRated®** can interchange with **Truflex®**, but **Truflex®** cannot interchange with **PowerRated®**.

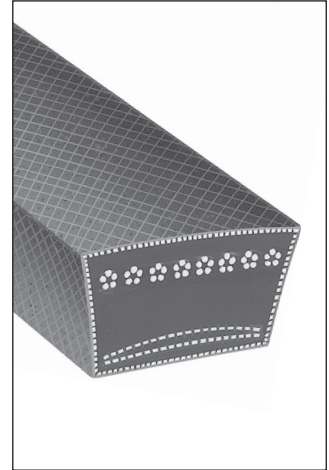

Synchronous Belts

These belts are also known as timing or positive drive belts and are used where driveN shaft speeds must be synchronized to the rotation of the driveR shafts. They can also be used to eliminate noise and maintenance problems caused by chain drives.

Synchronous belts, such as **Gates Poly Chain® GT® Carbon™**, can be used in high horsepower drives, drives where space is severely limited and where there is limited take up.

Synchronous drives are extremely efficient – as much as 98% with properly maintained **Poly Chain® GT® Carbon™** or **PowerGrip® GT®3** systems. By contrast, chain drives are in the 91-98% efficiency range, while V-belts average in the 93-98% range.

Distinctive tooth profiles (shapes) identify synchronous belts. Various sizes and constructions are available to meet a wide range of applications. The three important dimensions of a synchronous belt are pitch, width and pitch length. Tooth profiles must also be identified.

Belt Pitch - Distance in inches or millimeters between two adjacent tooth centers as measured on the belt's pitch line.

Belt Pitch Length - Circumference in inches or millimeters as measured along the pitch line.

Width - Top width in inches or millimeters.

Tooth Profile - See the Belt Identification section for the easiest way to identify tooth profile.

Synchronous belts run on sprockets, which are specified by the following:

Pitch - Distance between groove centers, measured on the sprocket pitch circle. The pitch circle coincides with the pitch line of the mating belt.

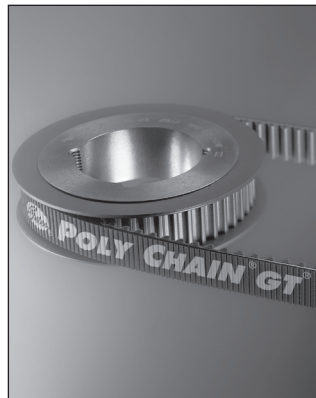

Number of Sprocket Grooves

Width - Face width.

Note: The sprocket's pitch diameter is always greater than its outside diameter.

Note: PowerGrip® GT®3 belts must be used with PowerGrip® GT®2 sprockets for new designs.

Note: 8 and 14 mm pitch PowerGrip® GT®3 belts can be used as replacement belts for competitive curvilinear tooth profiles. See page 32.

Example: 14mm-170mm width – substitute a PowerGrip® GT®3-14mm-115 without any performance loss. Refer to page 32 for crossover information.

BELT TYPES

Polyflex® JB® V-Belts

Polyflex® is a unique belt with a distinctive 60° belt angle and ribbed top specifically designed for long life in small diameter sheave drives. **Polyflex® JB®** is ideal for compact drives, drives with high speed ratios, and drives requiring especially smooth operation.

The “JB” refers to the belt’s configuration: two, three or five belts joined together to provide extra stability and improved performance. This joined belt style should be used instead of matched single belts whenever possible.

Polyflex® JB® belts are ideal for these applications:

- Milling, grinding or drilling machines
- Lathes
- Machine spindle drives
- Centrifuges
- Blowers
- High speed compressors

Polyflex® JB® belts are specified by Top Width and Effective Length



Multi-Speed Belts

(Variable Speed Drives)

Multi-Speed belts have a distinct shape. Multi-Speed belt top widths are usually greater than their thicknesses. This permits a greater range of speed ratios than standard belts. Usually cogged or notched on the underside, **Multi-Speed** belts are specified for equipment which require changes in driveN speed during operation.

Multi-Speed belts are specified by **Top Width**, **Outside Circumference**, and the required **Groove Angle**. The groove angle can be measured from the drive pulleys.

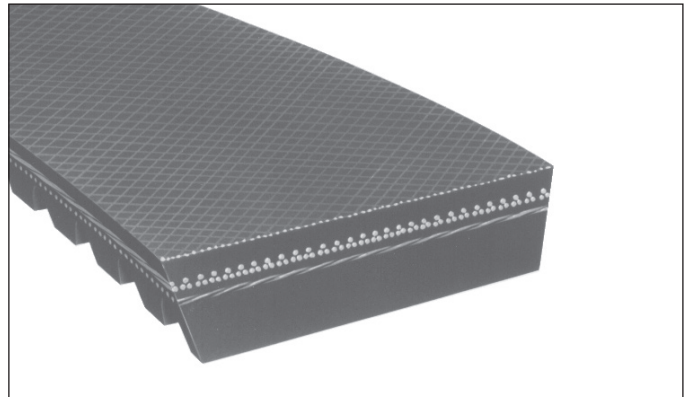

Micro-V® or V-Ribbed Belts

Gates Micro-V® belts outperform other V-ribbed belts because the tips of the “V” are truncated (shorter). This shorter profile gives the new **Micro-V belts** increased flexibility, reduced heat buildup and allows them to operate at extra high speeds on smaller diameter sheaves.

Additional advantages of the truncated tips are: (1) the belt does not bottom in the sheave, therefore providing a higher degree of wedging and (2) the belt can better tolerate debris in the sheave groove. They are extremely smooth running and highly resistant to oil, heat and other adverse conditions.

Three cross sections are available for industrial applications: J, L and M.

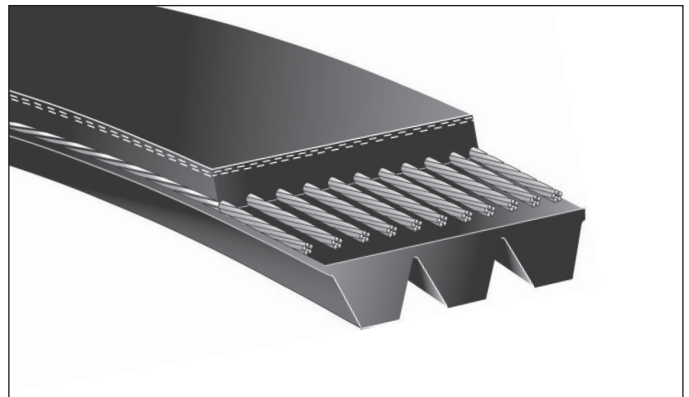

BELT STYLES

Spliced and Linked Belting

Used on drives with little or no take-up, or as an emergency belt replacement.

Belting is sold on reels in standard V-belt cross sections.

Easy-Splice V-belting ends are spliced with fasteners that require special assembly tools. Always use the correct fasteners with the correct belt type and cross section.



Nu-T-Link®, a high performance, linked belt, is also available for use as emergency belting, and for drives where conditions are detrimental to rubber belts.

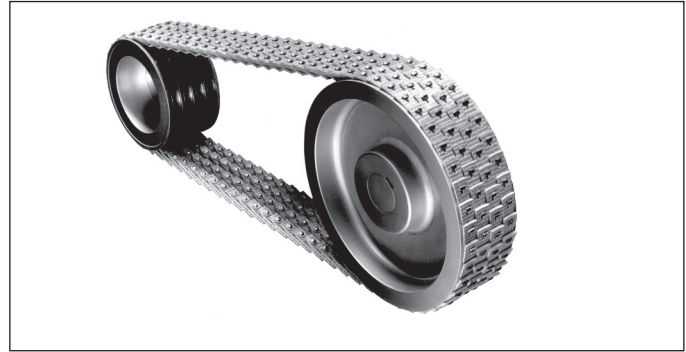

PowerBand® Belts

PowerBand belts were developed by Gates for drives subjected to pulsating loads, shock loads or extreme vibrations where single belts could flip over on the pulleys. A high-strength tie band permanently joins two or more belts to provide lateral rigidity. This keeps the belts running in a straight line in the pulley grooves. PowerBand® construction is offered with **Gates Hi-Power® II**, **Super HC®** and **Super HC® Molded Notch Belts**.

Predator® V-Belts

Gates Predator® V-belts are available in single, or multi-layered **PowerBand®** construction that adds strength, durability, shear and tear resistance and lateral rigidity to handle the toughest shock-loaded applications.

PREDATOR®

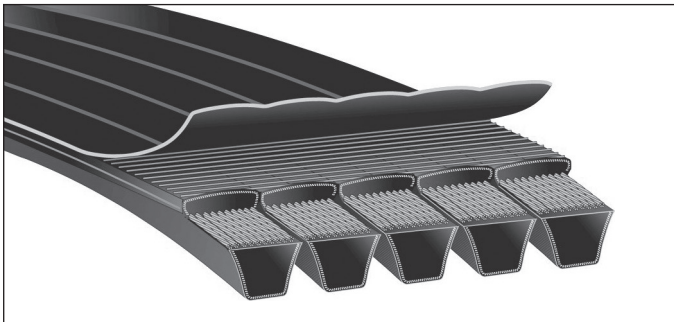

Primary features of **Predator® V-belts**:

- Aramid tensile cords for extraordinary strength, durability and virtually zero stretch.
- Chloroprene rubber compounds for superb oil and heat resistance.
- Specially-treated extra tough cover withstands slip and shear forces at peak loads without generating excessive heat. It also fends off penetration by foreign materials.
- Gates curves that compensate for effects that occur when belts bend around a sheave for uniform loading and maximum life.
- Matched by request to maximize power absorption and belt life.

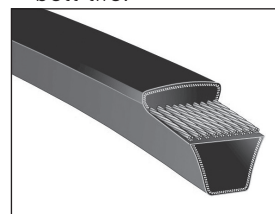

BELT STYLES

Round Endless Belts

Recommended for replacing leather belting on serpentine or quarter-turn drives. They are specified by **Diameter** and **Inside Length**.

If your current drive has leather or round endless belting, you should consider a new drive design. V-belt drives offer many advantages in performance, even on serpentine or quarter-turn drives.

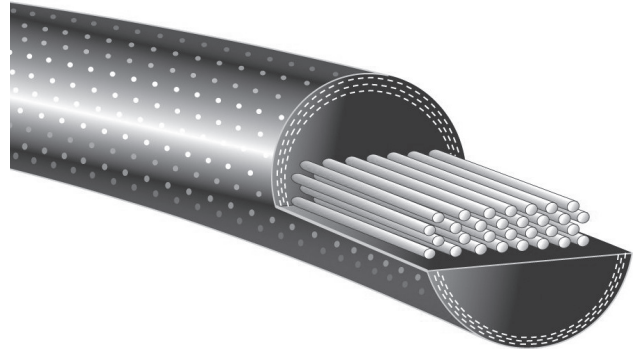

Also available in Heavy-Duty PowerRound® construction

PowerBack® V-Belts

PowerBack® belts are “B” section V-belts with a flat back surface. The flat back surface makes PowerBack® belts ideal for driving roll-to-roll conveyor applications.

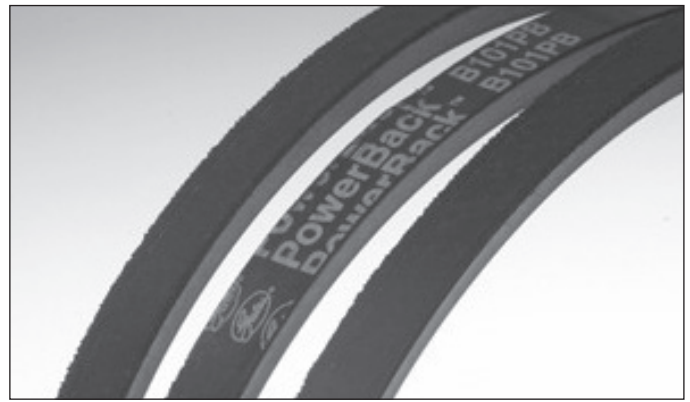

Power Curve® V-Belts

Power Curve® belts are “B” section V-belts offering increased flexibility for demanding power turn conveyor applications. The belts “bend” around corners and drive the rollers in most conveyor applications.



BELT STYLES

Dubl-V Belts

A special version of Gates Hi-Power® II for serpentine drives where power is transmitted by both the top and bottom of the belt. Dubl-V belts are specified by A, B, C or D cross sections, and by Effective Length.

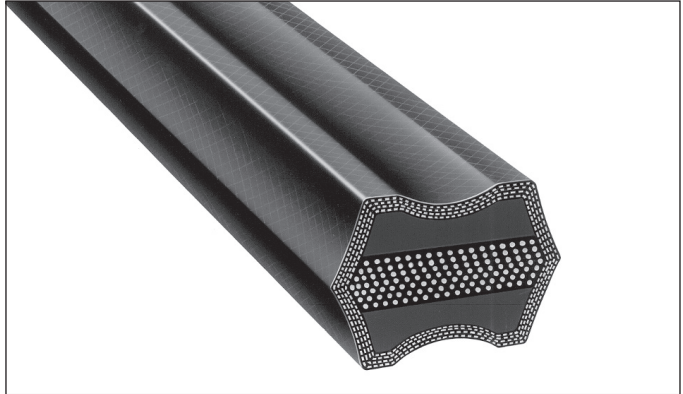

Static Conductive Belts

Static discharge can pose a hazard on belt drives that operate in potentially explosive environments. Static discharge can also interfere with radios, electronic instruments, or controls used in a facility. While uncommon, static discharge can also cause bearing pitting if the discharge occurs through the bearing. Static conductivity is a required belt characteristic in these cases in order to prevent static discharge.

V-belts are generally manufactured to be static conductive in accordance with the ARPM (Association for Rubber Products Manufacturers - Formerly RMA) IP 3-3 bulletin, but it is important to confirm with the belt manufacturer that a specific belt product or product line is static conductive.

Gates Hi-Power® II, Tri-Power®, Super HC®, Super HC® Molded Notch, Metric Power™, Micro-V®, Truflex® V-belts are all static conductive when new as defined by ARPM Bulletin IP 3-3. 8m, 14m Poly Chain® Carbon™ Volt® and 8m, 14m PowerGrip® GT3® belts are conductive as defined by ISO 9563.

PowerGrip® GT®2* in 2mm, 3mm, 5mm pitches, PowerGrip® Timing, Poly Chain® GT®, Poly Chain® GT®2, Poly Chain® GT® Carbon™, Polyflex®, Polyflex® JB®, PowerRated®, and Predator® belts are not considered to be static conductive.

PowerGrip® GT®3* in 2mm, 3mm, 5mm pitches and PowerGrip® Timing belts can be manufactured in a static conductive construction on a made-to-order basis.

When a belt is used in a hazardous environment, additional protection must be employed to assure that there are no accidental static spark discharges. The portion of the belt that contacts the sheave or sprocket must be conductive to ensure that static charge is conducted into the drive hardware. V-belts must have a static conductive sidewall in contact with a conductive sheave. Synchronous belts must have a static conductive tooth surface in contact with a conductive sprocket.

Unusual or excessive debris or contaminant on the belt contact surface or sheave or sprocket grooves should be cleaned and removed. Banded V-belts (V-belts with a fabric bandply on the driving surface) should be inspected for bandply wear. If the fabric bandply on the belt sidewall has worn away, the belts should be replaced immediately. Bandless V-belts do not have to be replaced if wear is evident on the belt sidewall. If there is any question about the belt's physical condition and its static conductivity characteristics, replace the belt.

Any belt drive system, whether it uses a synchronous belt or V-belt, that operates in a potentially hazardous environment must be properly grounded. A continuous conductive path to ground is necessary to bleed off the static charge. This path includes a static conductive belt, a conductive sheave or sprocket, a conductive bushing, a conductive shaft, conductive bearings, and the ground. As an additional measure of protection, a static-conductive brush or similar device should be employed to bleed off any residual static buildup that might remain around the belt.

* NOTE: 8mm pitch PGGT2 and PGGT3 belts at 12mm wide are NOT static conductive.

BELT DRIVE PERFORMANCE

To provide proper maintenance, you must understand the nature of the belt drives in your plant. You know the expected belt service life on each drive, and you are aware of the capabilities and limitations of this equipment.

On occasion, however, it is necessary to give some thought to belt service life, especially when belt service life is below the expected performance level and the situation must be improved.

Upgrade Drive Performance

A belt drive can sometimes be upgraded to improve performance. The first step is to see if simple improvements can be made at minimal costs. This involves checking the drive design for adequate capacity using the appropriate drive design manual or Gates Design Flex® Pro™ drive design software.

If further improvement is needed, the next step is to upgrade the drive to a higher performance belt system.

Here are examples of minor changes that could improve performance.

- Increase sheave or sprocket diameters
- Increase the number of belts, or use wider belt
- Add vibration dampening to system
- Improve guard ventilation to reduce operating temperature
- Use at least the correct, minimum recommended pulley diameters on inside and backside idlers
- Use premium belts rather than general purpose types
- Replace sheaves or sprockets when they are worn
- Keep sheaves or sprockets properly aligned
- Place idler on span with lowest tension
- Re-tension newly installed belts after a 4 to 24 hour run-in period
- Review proper belt installation and maintenance procedures

Gates Corporation is the recognized industry leader in product innovation and belt drive technology. New products and applications are continually made available to Gates customers. Here are examples of advanced Gates belt innovations.

Advanced Gates Belt Drive Products & Solutions

- Poly Chain® GT® Carbon™ positive drive (synchronous) belts
- Poly Chain® GT® Carbon™ Volt® positive drive (synchronous) belts
- PowerGrip® GT®3
- Polyflex® JB® belts
- PoweRated® light-duty V-Belts
- Super HC® Molded Notch V-Belts
- Super HC® XP™ (Notched Premium) V-Belts
- Predator® Single & PowerBand® belts
- Power Curve® V-Belts
- PowerBack® V-Belts
- Stainless steel sprockets & bushings (stock)
- Gates Design Flex® Pro™ Software
- Gates Design Flex® Mobile Online
- Gates Design IQ™ Software

Your local Gates distributor or representative can work with you to upgrade your existing drives and reduce your maintenance and down time costs.

Or, you may have a problem or excessive maintenance costs with a non-belt drive, such as gear or chain. Again, your local Gates distributor or representative can offer you excellent advice as to whether or not a belt drive could solve the problem and reduce your maintenance costs.



BELT DRIVE PERFORMANCE

In most cases, synchronous belt drives that are using non-Gates curvilinear belts can be changed to a Gates PowerGrip® GT®3 belt to reduce width. Use the table below to identify product types that can be converted, and what widths are recommended.

PowerGrip® GT®3 – 8 & 14mm belts can be used to replace other non-Gates curvilinear belts in the next smallest width.

Company	Product Trade Name	Profile	Nomenclature	Belt-Pitch
Bando	Syncro-Link® – HT	H†	1600-8M-20-H	8 & 14MM
Dodge	HT100	GT	1600-8M-20	8 & 14MM
Gates	HTD®	HTD	1600-8M-20	8 & 14MM
Jason	HTB®	H†	1600-8M-20	8 & 14MM
Browning	HPT®	RPP	1600-14M-20	8* & 14MM
Goodyear	HPPD™	RPP	1600-14M-20	8* & 14MM
Dayco/Carlisle	RPP®/RPP Plus®	RPP	1600-14M-20	8* & 14MM
Dodge	HT150	GT	1600-14M-20	8 & 14MM
T.B. Wood's	RPP®/RPP Plus®	RPP	1600-14M-20	8* & 14MM

Competitors' Width	PowerGrip GT3 – Width
8MM – Pitch	8MM – Pitch
20	20
30	20
50	30
85	50

Competitors' Width	PowerGrip GT3 – Width
14MM – Pitch	14MM – Pitch
40	40
55	40
85	55
115	85

* Replacement only on sprockets with fewer than 50 grooves

† See Association of Rubber Products Manufacturers bulletin IP-27 (1997) for H type tooth profile specification information

For example, a competitor's belt in 14mm pitch, 85mm wide, can be replaced with a narrower 55mm Gates PowerGrip® GT®3 belt.

Reference www.gates.com/interchange for electronic interchange information.

NOISE

V-belt, synchronous belt, roller chain, and gear drives will all generate noise while transmitting power. Each type of system has its own characteristic sound. V-belt drives tend to be the quietest belt drives, and synchronous belt drives are much quieter than roller chain drives. When noise is an issue, there are several design and maintenance tips that should be followed to achieve the quietest possible belt drive.

Noise: Decibel and Frequency

Noise is an unwanted or unpleasant sound that can be described with two criteria – frequency and decibel (dBA) levels. Frequency is measured in Hertz.

The human ear is capable of distinguishing frequencies typically from 20 to 20,000 Hertz. The human ear generally does not perceive frequencies higher than 20,000 Hertz.

The noise level or intensity of noise is measured in terms of decibels (dBA). The decibel has become the basic unit of measure since it is an objective measurement that approximately corresponds to the subjective measurement made by the human ear. Since sound is composed of several distinct and measurable parts and the human ear doesn't differentiate between these parts, measuring scales that approximate the human ear's reaction have been adopted. Three scales – A, B, and C are used to duplicate the ear's response over the scale's ranges. The A scale is most commonly used in industry because of its adoption as the standard in OSHA regulations.

Noise described in decibels (dBA) is generally perceived as the loudness or intensity of the noise.

While the human ear can distinguish frequencies from 20 to 20,000 Hertz, the ear is most sensitive in the range of normal speech – 500 to 2000 Hertz. As a consequence, this range is the most common concern for noise control. Frequency is most closely related to what the ear hears as pitch. High frequency sounds are perceived as whining or piercing, while low frequency sounds are perceived as rumbling.

The combination of decibel and frequency describes the overall level of loudness to the human ear. One without the other does not adequately describe the loudness potential of the noise. For example, an 85 dBA noise at 3000 Hertz is going to be perceived as much louder than an 85 dBA noise at 500 Hertz.

For comparison, some typical noise levels and their sources are listed below.

Normal Speech	60 dBA
Busy Office	80 dBA
Textile Weaving Plant	90 dBA
Canning Plant	100 dBA
Heavy City Traffic	100 dBA
Punch Press	110 dBA
Air Raid Siren	130 dBA
Jet Engine	160 dBA

Reducing Noise

Following proper installation and maintenance procedures, as well as some simple design alternatives can reduce belt drive noise.

Belt Drive Tension and Alignment

Properly tensioning and aligning a belt drive will allow the belt drive to perform at its quietest level.

Improperly tensioned V-belt drives can slip and squeal. Improper tension in synchronous belt drives can affect how the belt fits in the sprocket grooves. Proper tension minimizes tooth to groove interference, and thereby reduces belt noise. Check to make sure that the drive is properly tensioned by using Gates tension measurement gauges.

Misaligned V-belt drives will be noisier than properly aligned drives since interference is created at the belt's entry point into the sheave. Misaligned synchronous belt drives tend to be much noisier than properly aligned drives due to the even greater amount of interference that is created between the belt teeth and the sprocket grooves. Misaligned synchronous belt drives may cause belt tracking that forces the edge of the belt to ride hard against a sprocket flange. Misalignment causing belt contact with a flange will generate noise that is easily detected. Follow the guidelines discussed in the installation section of this manual for checking and correcting alignment.

Noise Barriers and Absorbers

Sometimes, even properly aligned and tensioned belt drives may be too noisy for a work environment. When this occurs, steps can be taken to modify the drive guard to reduce the noise level.

Noise barriers are used to block and reflect noise. Noise barriers do not absorb or deaden the noise; they block the noise and generally reflect most of the noise back towards its point of origin. Good noise barriers are dense, and should not vibrate. A sheet metal belt guard is a noise barrier. The more complete the enclosure is, the more effective it is as a noise barrier. Noise barrier belt guards can be as sophisticated as a completely enclosed case, or as simple as sheet metal covering the front of the guard to prevent direct sound transmission.

Noise absorbers are used to reduce noise reflections and to dissipate noise energy. Noise absorbers should be used in combination with a noise barrier. Noise absorbers are commonly referred to as acoustic insulation. Acoustic insulation (the noise absorber) is used inside of belt guards (the noise barrier) where necessary. A large variety of acoustic insulation manufacturers are available to provide different products for the appropriate situation.

A combination of noise barrier (solid belt guard) and noise absorber (acoustic insulation) will provide the largest reduction in belt drive noise. While the noise reduction cannot be predicted, field experience has shown that noise levels have been reduced by 10 to 20 dBA when using complete belt guards with acoustic insulation.

SPROCKET CORROSION PREVENTION

Poly Chain® GT® Carbon™ belt drives are excellent replacements for roller chain drives. Poly Chain® GT® Carbon™ belt drives offer significant maintenance savings and performance advantages over roller chain drives on applications that operate in corrosive environments. Synchronous belt drives also provide energy savings compared to V-belt drives. Some of these applications may also operate in corrosive environments.

Corrosive Environments

Many applications in the food and beverage industry are located in areas that require periodic wash down. Unless a drive is completely shielded and protected from wash down, rust and corrosion will be rapidly apparent in these types of environments.

Applications that are located in environments that have high humidity or moisture content will also develop sprocket and bushing corrosion. Examples of these types of environments are pulp processing applications and cooling tower applications that pass moist air over the belt drive.

Effects of Corrosion

Corrosion will attack the sprocket grooves, building up rust deposits. The corrosion will increase over time, building up in the sprocket grooves and non-driving surfaces (flanges, sprocket faces, bushing face).

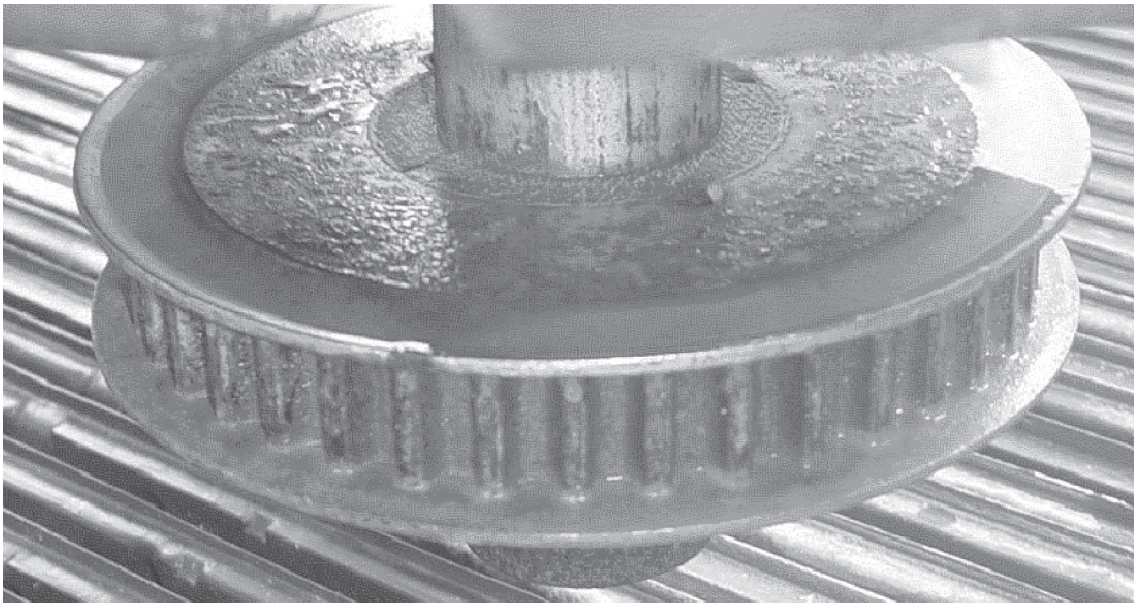

Sprockets with corrosion in the grooves will rapidly wear the belt's teeth. Sprockets with corroded grooves will wear through the abrasion resistant tooth fabric, resulting in tooth shear and premature belt failure.

SPROCKET CORROSION PREVENTION

Preventing Corrosion

Sprocket corrosion can be prevented by using Gates stainless steel Poly Chain® GT®2 sprockets and bushings. Sprockets can also be electroless nickel plated. Both solutions will eliminate corrosion as a cause of failure on belt drives located in these damaging environments.

The sprocket shown below has been electroless nickel plated. Compare the grooves to the unprotected corroded sprocket shown on page 35.

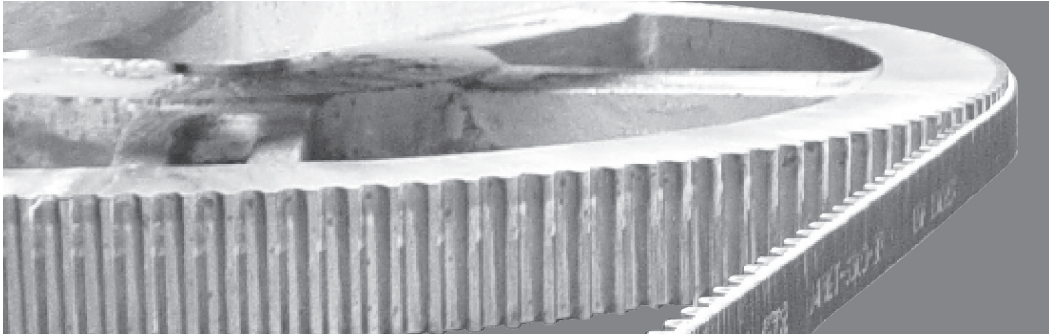

The photo below illustrates the difference in wear between belts running on properly plated sprockets and those running on corroded sprockets. The wear on the belt running on corroded sprockets is severe and will result in a greatly shortened belt life.

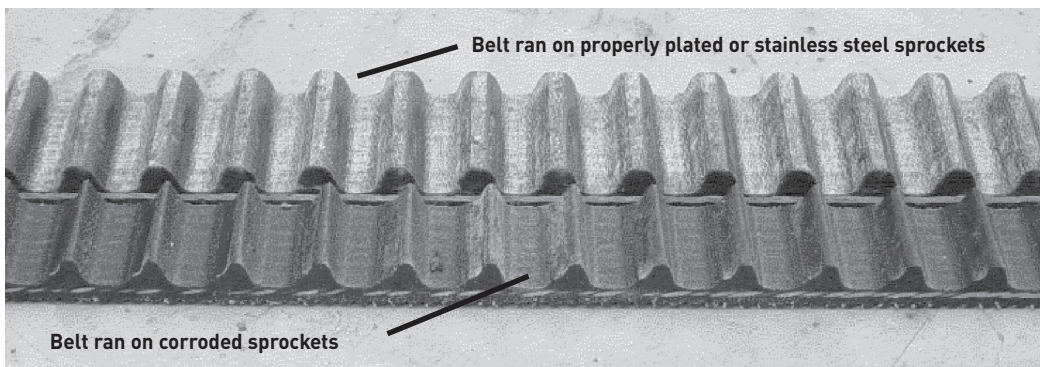

TROUBLESHOOTING GUIDE

When troubleshooting a drive problem, the goal is to identify the cause(s), then take appropriate corrective action. The following steps should be followed to help with this process.

1. Describe the drive problem as accurately as possible. Use Step 1 as a guide. Use this step as a guide in the troubleshooting process.
2. Go through the list of "Drive Symptoms". Check those symptoms that are observed and record them, as well as observations of anything unusual about the drive.
3. Go through the "Problem/Solution Summary Table". List the probable cause(s) and corrective action. Also, review the list of observations.
4. After identifying probable causes and corrective action, review and implement.

What to Do When All Else Fails

If the problem still exists after all troubleshooting efforts have been exhausted, contact the local Gates distributor. If the local distributor cannot solve the problem, a qualified Gates representative can be contacted. Save the failed belt(s) for further inspection.

Gates Power Transmission Product Application engineers are also available at ptpasupport@gates.com or (303) 744-5800 to answer additional drive design and troubleshooting questions.



Step 1

Describe the problem

- *What is wrong?*
- *When did it happen?*
- *How often does it happen?*
- *What is the drive application?*
- *Have the machine operations or output changed?*
- *What kind of belt(s) are being used?*
- *What are the expectations for belt performance in this application?*

Step 2

Identify symptoms and record observations of anything unusual.

V-Belt Drive Symptoms

Check List

(Check those that are observed)

• Premature Belt Failure

- Broken belt(s)
- Belt(s) fail to carry load (slip). No visible reason
- Edge cord failure
- Belt delamination or undercord separation

• Severe or Abnormal Belt Wear

- Wear on belt top surface
- Wear on top corners of belt
- Wear on belt sidewall
- Wear on belt bottom corners
- Wear on bottom surface of belt
- Undercord cracking
- Burn or hardening on bottom or sidewall
- Belt surface flaking, sticky or swollen
- Belt stretch
- Extensive hardening of belt exterior

TROUBLESHOOTING GUIDE

V-Belt Drive Symptoms Checklist—cont.

• Problems with PowerBand® Belts

- Tie-band separation
- Top of tie-band frayed, worn or damaged
- Band comes off drive
- One or more ribs run outside of pulley

• V-Belt Turns Over or Jumps off Sheave

- Single belt
- One or more belts in a set
- Joined or banded belts

• Problems with Belt Take-Up

- Single belt
- Multiple belts stretch unequally
- All belts stretch equally
- Belts do not match

• V-Belt Noise

- Squeal or “chirp”
- Slapping noise
- Rubbing sound
- Grinding
- Unusually loud drive

• Unusual Vibration

- Belts flopping
- Excessive vibration in drive system

• Problem With Sheaves

- Broken or damaged
- Severe, rapid groove wear

• Problems With Drive Components

- Bent or broken shafts
- Hot bearings

Synchronous Drive Symptoms Checklist

• Belt Problems

- Unusual noise
- Tension loss
- Excessive belt edge wear
- Tensile break
- Cracking
- Premature tooth wear
- Tooth shear
- Belt ratcheting
- Land area worn

• Sprocket Problems

- Flange failure
- Unusual wear
- Rusted or corroded

• Performance Problems

- Incorrect driveN speeds
- Belt tracking problems
- Excessive temperature: bearings, housings, shafts, etc.
- Shafts out of sync
- Vibration

PROBLEM/SOLUTION SUMMARY TABLE

V-Belt Drive Symptoms

Premature Belt Failure

Symptoms	Probable Cause	Corrective Action
<p>Broken belt(s)</p> 	<ol style="list-style-type: none"> 1. Under-designed drive 2. Belt rolled or pried onto sheave 3. Object falling into drive 4. Severe shock load 	<ol style="list-style-type: none"> 1. Redesign, using Gates manual. 2. Use drive take-up when installing. 3. Provide adequate guard or drive protection. 4. Redesign to accommodate shock load.
<p>Belts fail to carry load, no visible reason</p>	<ol style="list-style-type: none"> 1. Underdesigned drive 2. Damaged tensile member 3. Worn sheave grooves 4. Center distance movement 	<ol style="list-style-type: none"> 1. Redesign, using Gates manual. 2. Follow correct installation procedure. 3. Check for groove wear; replace as needed. 4. Check drive for center distance movement during operation.
<p>Edge cord failure</p>	<ol style="list-style-type: none"> 1. Pulley misalignment 2. Damaged tensile member 	<ol style="list-style-type: none"> 1. Check alignment and correct. 2. Follow correct installation procedure.
<p>Belt de-lamination or undercord separation</p>	<ol style="list-style-type: none"> 1. Too small sheaves 2. Use of too small backside idler 	<ol style="list-style-type: none"> 1. Check drive design, replace with larger sheaves. 2. Increase backside idler to acceptable diameter.

NOTE: Belt Failure Analysis poster #12975 available. Contact your Gates Representative.



PROBLEM/SOLUTION SUMMARY TABLE

Severe or Abnormal V-Belt Wear

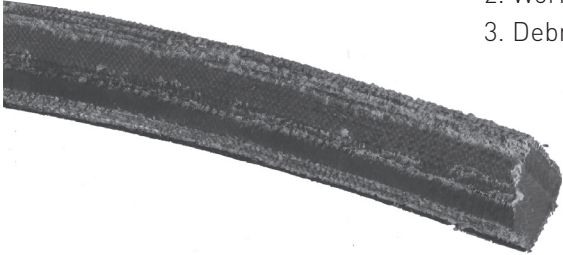
Symptoms	Probable Cause	Corrective Action
Wear on top surface of belt	<ol style="list-style-type: none"> 1. Rubbing against guard 2. Idler malfunction 	<ol style="list-style-type: none"> 1. Replace or repair guard. 2. Replace idler.
Wear on top corner of belt	<ol style="list-style-type: none"> 1. Belt-to-sheave fit incorrect (belt too small for groove) 	<ol style="list-style-type: none"> 1. Use correct belt-to-sheave combination.
		
Wear on belt sidewalls	<ol style="list-style-type: none"> 1. Belt slip 2. Misalignment 3. Worn sheaves 4. Incorrect belt 	<ol style="list-style-type: none"> 1. Retention until slipping stops. 2. Realign sheaves. 3. Replace sheaves. 4. Replace with correct belt size.
Wear on bottom corner of belt	<ol style="list-style-type: none"> 1. Belt-to-sheave fit incorrect 2. Worn sheaves 	<ol style="list-style-type: none"> 1. Use correct belt-to-sheave combination. 2. Replace sheaves.
Wear on bottom surface of belt	<ol style="list-style-type: none"> 1. Belt bottoming on sheave groove 2. Worn sheaves 3. Debris in sheaves 	<ol style="list-style-type: none"> 1. Use correct belt/sheave match. 2. Replace sheaves. 3. Clean sheaves.
		
Undercord cracking	<ol style="list-style-type: none"> 1. Sheave diameter too small 2. Belt slip 3. Backside idler too small 4. Improper storage 	<ol style="list-style-type: none"> 1. Use larger diameter sheaves. 2. Retention. 3. Use larger diameter backside idler. 4. Don't coil belt too tightly, kink or bend. Avoid heat and direct sunlight.

PROBLEM/SOLUTION SUMMARY TABLE

Severe or Abnormal V-Belt Wear—cont.

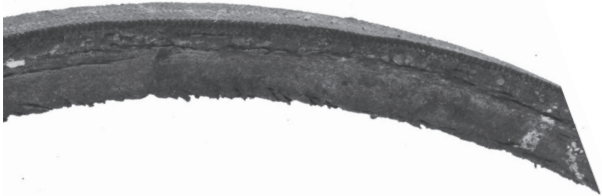
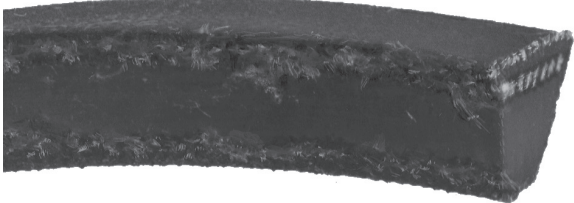
Symptoms	Probable Cause	Corrective Action
Undercord or sidewall burn or hardening 	<ol style="list-style-type: none"> 1. Belt slipping 2. Worn sheaves 3. Underdesigned drive 4. Shaft movement 	<ol style="list-style-type: none"> 1. Retension until slipping stops. 2. Replace sheaves. 3. Refer to Gates drive manual. 4. Check for center distance changes.
Belt surface hard or stiff	<ol style="list-style-type: none"> 1. Hot drive environment 	<ol style="list-style-type: none"> 1. Improve ventilation to drive.
Belt surface flaking, sticky or swollen 	<ol style="list-style-type: none"> 1. Oil or chemical contamination 	<ol style="list-style-type: none"> 1. Do not use belt dressing. Eliminate sources of oil, grease or chemical contamination.

Problems With PowerBand® Belts

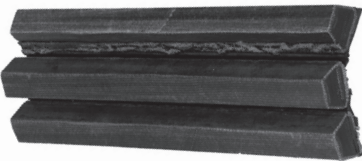
Symptoms	Probable Cause	Corrective Action
Tie band separation 	<ol style="list-style-type: none"> 1. Worn sheaves 2. Improper groove spacing 	<ol style="list-style-type: none"> 1. Replace sheaves. 2. Use standard groove sheaves.
Top of tie band frayed or worn 	<ol style="list-style-type: none"> 1. Interference with guard 2. Backside idler malfunction or damaged 	<ol style="list-style-type: none"> 1. Check guard. 2. Replace or repair backside idler
PowerBand® belt comes off drive repeatedly	<ol style="list-style-type: none"> 1. Debris in sheaves 2. Misalignment 	<ol style="list-style-type: none"> 1. Clean grooves. Use single belts to prevent debris from being trapped in grooves. 2. Realignment drive.

PROBLEM/SOLUTION SUMMARY TABLE

Problems With PowerBand® Belts—cont.

Symptoms	Probable Cause	Corrective Action
One or more “ribs” runs out of pulley	<ol style="list-style-type: none"> 1. Misalignment 2. Undertensioned 	<ol style="list-style-type: none"> 1. Realign drive. 2. Retension.

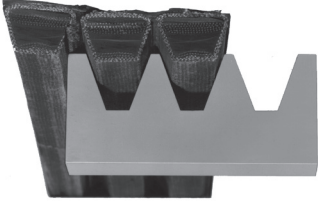

V-Belts Turn Over or Come Off Drive

Symptoms	Probable Cause	Corrective Action
Involves single or multiple belts	<ol style="list-style-type: none"> 1. Shock loading or vibration 2. Foreign material in grooves 3. Misaligned sheaves 4. Worn sheave grooves 5. Damaged tensile member 6. Incorrectly placed flat idler 7. Mismatched belt set 8. Poor drive design 	<ol style="list-style-type: none"> 1. Check drive design. Use Gates PowerBand® belts or Power Cable® belts. 2. Shield grooves and drive. 3. Realign the sheaves. 4. Replace sheaves. 5. Use correct installation and belt storage procedure. 6. Carefully align flat idler on slack side of drive as close as possible to driver sheaves. 7. Replace with Gates matched belts. <u>Do not mix old and new belts.</u> 8. Check for center distance stability and vibration dampening.

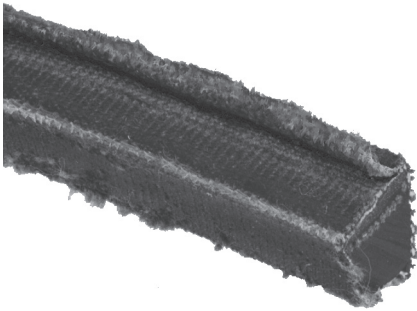

Problems with V-Belt Take-Up

Symptoms	Probable Cause	Corrective Action
Multiple belts stretch unequally	<ol style="list-style-type: none"> 1. Misaligned drive 2. Debris in sheaves 3. Broken tensile member or cord damaged 4. Mismatched belt set 	<ol style="list-style-type: none"> 1. Realign and retension drive. 2. Clean sheaves. 3. Replace all belts, install properly. 4. Install Gates matched belt set.
Single belt, or where all belts stretch evenly	<ol style="list-style-type: none"> 1. Insufficient take-up allowance 2. Grossly overloaded or under designed drive 3. Broken tensile members 	<ol style="list-style-type: none"> 1. Check take-up. Use allowance specified in Gates design manuals. 2. Redesign drive. 3. Replace belt, install properly.
Belts do not match	<ol style="list-style-type: none"> 1. Not all belts are from the same manufacturer 	<ol style="list-style-type: none"> 1. Use Gates belts.

PROBLEM/SOLUTION SUMMARY TABLE

V-Belt Noise

Symptoms	Probable Cause	Corrective Action
Belt squeals or chirps	<ol style="list-style-type: none"> 1. Belt slip 2. Contamination 	<ol style="list-style-type: none"> 1. Retension. 2. Clean belts and sheaves.
Slapping Sound	<ol style="list-style-type: none"> 1. Loose belts 2. Mismatched set 3. Misalignment 	<ol style="list-style-type: none"> 1. Retension. 2. Install matched belt set. 3. Realign pulleys so all belts share load equally.
Rubbing sound	<ol style="list-style-type: none"> 1. Guard interference 	<ol style="list-style-type: none"> 1. Repair, replace or redesign guard.
Grinding sound	<ol style="list-style-type: none"> 1. Damaged bearings 	<ol style="list-style-type: none"> 1. Replace, align & lubricate.
Unusually loud drive	<ol style="list-style-type: none"> 1. Incorrect belt 2. Incorrect Tension 3. Worn sheaves 4. Debris in sheaves 	<ol style="list-style-type: none"> 1. Use correct belt size. Use correct belt tooth profile for sprockets on synchronous drive. 2. Check tension and adjust. 3. Replace sheaves. 4. Clean sheaves, improve shielding, remove rust, paint, or remove dirt from grooves.

Unusual Vibration

Symptoms	Probable Cause	Corrective Action
Belts flopping	<ol style="list-style-type: none"> 1. Loose belts (under tensioned) 2. Mismatched belts 3. Pulley misalignment 	<ol style="list-style-type: none"> 1. Retension. 2. Install Gates matched belts. 3. Align pulley.
Unusual or excessive vibration	<ol style="list-style-type: none"> 1. Incorrect belt 2. Poor machine or equipment design 3. Pulley out of round 4. Loose drive components 	<ol style="list-style-type: none"> 1. Use correct belt cross section in pulley. Use correct tooth profile and pitch in sprocket. 2. Check structure and brackets for adequate strength. 3. Replace with non-defective pulley. 4. Check machine components and guards, motor mounts, motor pads, bushings, brackets and framework for stability, adequate design strength, proper maintenance and proper installation.

Problems With Sheaves

Symptoms	Probable Cause	Corrective Action
Broken or damaged sheave	<ol style="list-style-type: none"> 1. Incorrect sheave installation 2. Foreign objects falling into drive 3. Excessive rim speeds 4. Incorrect belt installation 	<ol style="list-style-type: none"> 1. Do not tighten bushing bolts beyond recommended torque values. 2. Use adequate drive guard. 3. Keep pulley rim speeds below maximum recommended value. 4. Do not pry belts onto pulleys.
Severe Groove Wear	<ol style="list-style-type: none"> 1. Excessive belt tension 2. Sand, debris or contamination 3. Wrong belt 	<ol style="list-style-type: none"> 1. Retension, check drive design. 2. Clean and shield drive as well as possible. 3. Make sure belt and sheave combination is correct.



PROBLEM/SOLUTION SUMMARY TABLE

Problem With Other Drive Components

Symptoms	Probable Cause	Corrective Action
Bent or broken shaft	<ol style="list-style-type: none"> 1. Extreme belt overtension 2. Overdesigned drive* 3. Accidental damage 4. Machine design error 5. Accidental damage to guard or poor guard design 6. Pulley mounted too far away from outboard bearing 	<ol style="list-style-type: none"> 1. Retension. 2. Check drive design, may need to use smaller or fewer belts. 3. Redesign drive guard. 4. Check machine design. 5. Repair, redesign for durability. 6. Move pulley closer to bearing.
Hot Bearings	<ol style="list-style-type: none"> 1. Worn grooves - belts bottoming and won't transmit power until overtensioned* 2. Improper tension 3. Motor manufacturer's sheave diameter recommendation not followed 4. Bearing underdesigned 5. Bearing not properly maintained 6. Sheaves too far out on shaft 7. Belt Slippage 	<ol style="list-style-type: none"> 1. Replace sheaves. Tension drive properly. 2. Retension. 3. Redesign using drive design manual. 4. Check bearing design. 5. Align and lubricate bearing. 6. Place sheaves as close as possible to bearings. Remove obstructions 7. Retension.

* Using too many belts, or belts that are too large, can severely stress motor or driveN shafts. This can happen when load requirements are reduced on a drive, but the belts are not redesigned accordingly. This can also happen when a drive is greatly overdesigned. Forces created from belt tensioning are too great for the shafts.

Synchronous Drive Symptoms

Synchronous Belt Problems

Symptoms	Probable Cause	Corrective Action
Unusual noise	<ol style="list-style-type: none"> 1. Misaligned drive 2. Too low or high tension 3. Backside idler 4. Worn sprocket 5. Bent guide flange 6. Belt speed too high 7. Incorrect belt profile for sprocket 8. Subminimal diameter 9. Excessive load 	<ol style="list-style-type: none"> 1. Correct alignment. 2. Adjust to recommended value. 3. Use inside idler. 4. Replace. 5. Replace. 6. Redesign drive. 7. Use proper belt/sprocket combination. 8. Redesign drive using larger diameters. 9. Redesign drive for increased capacity.

NOTE: Belt Failure Analysis poster #12975 available. Contact your Gates Representative.

PROBLEM/SOLUTION SUMMARY TABLE

Synchronous Belt Problems—cont.

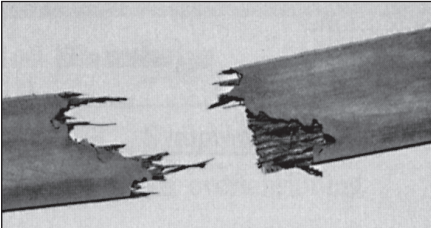
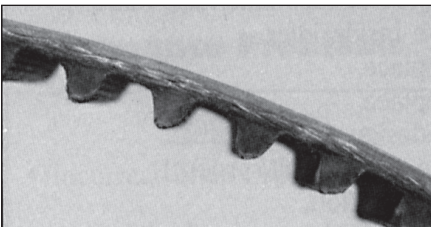
Symptoms	Probable Cause	Corrective Action
Tension Loss	<ol style="list-style-type: none"> 1. Weak support structure 2. Excessive sprocket wear 3. Fixed (non-adjustable) centers 4. Excessive debris 5. Excessive load 6. Subminimal diameter 7. Belt, sprocket or shafts running too hot 8. Unusual belt degradation 	<ol style="list-style-type: none"> 1. Reinforce structure. 2. Use alternate sprocket material. 3. Use inside idler for belt adjustment. 4. Remove debris, check guard. 5. Redesign drive for increased capacity. 6. Redesign drive using larger diameters. 7. Check for conductive heat transfer from prime mover. 8. Reduce ambient drive temperature to 185°F maximum.
Excessive Belt Edge Wear	<ol style="list-style-type: none"> 1. Damage due to handling 2. Flange damage 3. Belt too wide 4. Belt tension too low 5. Rough flange surface finish 6. Improper tracking 7. Belt hitting drive guard or bracketry 8. Misalignment 	<ol style="list-style-type: none"> 1. Follow proper handling instructions. 2. Repair flange or replace sprocket. 3. Use proper width sprocket. 4. Adjust tension to recommended value. 5. Replace or repair flange (to eliminate abrasive surface). 6. Correct alignment. 7. Remove obstruction or use inside idler. 8. Realign drive.
Tensile Break 	<ol style="list-style-type: none"> 1. Excessive shock load 2. Subminimal diameter 3. Improper belt handling and storage prior to installation (crimping) 4. Debris or foreign object in drive 5. Extreme sprocket run-out 	<ol style="list-style-type: none"> 1. Redesign drive for increased capacity. 2. Redesign drive using larger diameters. 3. Follow proper storage and handling procedures. 4. Remove objects and check guard. 5. Replace sprocket.
Belt Cracking	<ol style="list-style-type: none"> 1. Subminimal diameter 2. Backside idler 3. Extreme low temperature at start-up. 4. Extended exposure to harsh chemicals 5. Cocked bushing/sprocket assembly 	<ol style="list-style-type: none"> 1. Redesign drive using larger diameter. 2. Use inside idler or increase diameter of backside idler. 3. Pre-heat drive environment. 4. Protect drive. 5. Install bushing per instructions.
Premature Tooth Wear 	<ol style="list-style-type: none"> 1. Too low or high belt tension 2. Belt running partly off unflanged sprocket 3. Misaligned drive 4. Incorrect belt profile for sprocket 5. Worn sprocket 6. Rough sprocket teeth 	<ol style="list-style-type: none"> 1. Adjust to recommended value. 2. Correct alignment. 3. Correct alignment. 4. Use proper belt/sprocket combination. 5. Replace. 6. Replace sprocket.

PROBLEM/SOLUTION SUMMARY TABLE

Synchronous Belt Problems-cont.

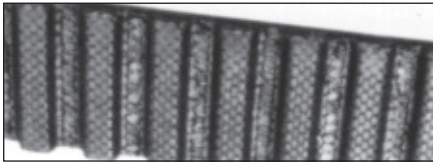
Symptoms	Probable Cause	Corrective Action
Premature Tooth Wear-cont.	<ol style="list-style-type: none"> 7. Damaged sprocket 8. Sprocket not to dimensional specification 9. Belt hitting drive bracketry or other structure 10. Excessive load 11. Insufficient hardness of sprocket material 12. Excessive debris 13. Cocked bushing/sprocket assembly 	<ol style="list-style-type: none"> 7. Replace. 8. Replace. 9. Remove obstruction or use idler. 10. Redesign drive for increased capacity. 11. Use a more wear-resistant sprocket. 12. Remove debris, check guard. 13. Install bushing per instructions.
Tooth Shear 	<ol style="list-style-type: none"> 1. Excessive shock loads 2. Less than 6 teeth-in-mesh 3. Extreme sprocket run-out 4. Worn sprocket 5. Backside idler 6. Incorrect belt profile for the sprocket 7. Misaligned drive 8. Belt undertensioned 	<ol style="list-style-type: none"> 1. Redesign drive for increased capacity. 2. Redesign drive. 3. Replace sprocket. 4. Replace. 5. Use inside idler. 6. Use proper belt/sprocket combination. 7. Realign. 8. Adjust tension to recommended value.
Belt Ratcheting	<ol style="list-style-type: none"> 1. Drive is undertensioned 2. Excessive shock loads 3. Drive framework not rigid 	<ol style="list-style-type: none"> 1. Adjust tension to recommended value. 2. Redesign drive for increased capacity. 3. Reinforce system.
Land Area Worn	<ol style="list-style-type: none"> 1. Excessive tension 2. Excessive sprocket wear 	<ol style="list-style-type: none"> 1. Adjust tension to recommended value. 2. Check sprocket condition. Replace if necessary.

Synchronous Sprocket Problems

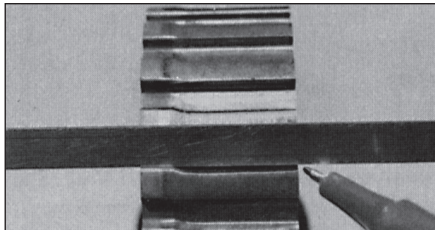
Symptoms	Probable Cause	Corrective Action
Flange Failure	<ol style="list-style-type: none"> 1. Belt forcing flange off 	<ol style="list-style-type: none"> 1. Correct alignment or properly secure flange to sprocket.
Unusual Sprocket Wear 	<ol style="list-style-type: none"> 1. Sprocket has too little wear resistance (i.e. plastic, aluminum, soft metals) 2. Misaligned drive 3. Excessive debris 4. Excessive load 5. Belt tension too low or high 6. Incorrect belt profile 	<ol style="list-style-type: none"> 1. Use alternate sprocket material. 2. Correct alignment. 3. Remove debris, check guard. 4. Redesign drive for increased capacity. 5. Adjust tension to recommended value. 6. Use proper belt/sprocket combination.

PROBLEM/SOLUTION SUMMARY TABLE

Synchronous Sprocket Problems-cont.

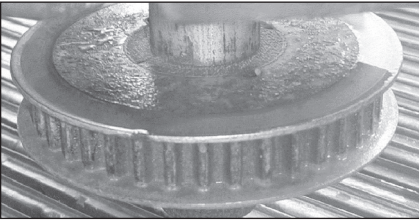
Symptoms	Probable Cause	Corrective Action
Rust and Corrosion 	1. Rust caused by high moisture conditions in the production area, or by the use of water-based cleaning solutions.	1. Replace cast iron sprockets with nickel plated or stainless steel sprockets and use stainless steel bushings.

Performance Problems

Symptoms	Probable Cause	Corrective Action
Incorrect driveN speed	1. Design error	1. Use correct driveR/driveN sprocket size for desired speed ratio.
Belt Tracking	1. Belt running partly off unflanged sprocket 2. Centers exceed 8 times small sprocket diameter 3. Excessive belt edge wear	1. Correct alignment. 2. Correct parallel alignment to set belt to track on both sprockets. Flange both sprockets. 3. Correct alignment.
Excessive Temperature (Belt, Bearing, Housing, Shafts, etc.)	1. Misaligned drive 2. Too low or high belt tension 3. Incorrect belt profile	1. Correct alignment. 2. Adjust tension to recommended value. 3. Use proper belt/sprocket combination.
Shafts Out of Sync	1. Design error 2. Incorrect belt	1. Use correct sprocket sizes. 2. Use correct belt with correct tooth profile for grooves.
Vibration	1. Incorrect belt profile for the sprocket 2. Too low or high belt tension 3. Bushing or key loose	1. Use proper belt/sprocket combination. 2. Adjust tension to recommended value. 3. Check and reinstall per instructions.

NOTE: Belt Failure Analysis poster #12975 available. Contact your Gates Representative.



MAINTENANCE TOOLS

The tools available to help troubleshoot drive problems range from the surprisingly simple to complicated. Following is a list of tools that can be used to effectively diagnose a problem. While Gates does not sell all of the items discussed in this section, the items are readily available from industrial instrumentation outlets throughout the United States.

Eyes, Ears & Nose

When troubleshooting a belt drive problem, stand back and observe the drive while it is in operation and at rest. Is there a warm rubber smell? Is there anything unusual about the way the belt travels around the drive? Is the drive frame flexing under load? Are there chirping, squealing or grinding noises? Is there an accumulation of dust or debris beneath the drive which might interfere with the belts?

Squirt Bottle With Soapy Water

When a belt drive is excessively noisy, the belt is often incorrectly blamed. It is easy to eliminate the belt as the problem by spraying it with soapy water while it is running. If the noise goes away, or decreases, then the belt is part of the problem. If the same noise is still present, the problem is likely due to other drive components.

String

Variation in drive center distance, often caused by weak supporting structure, can cause problems from vibration to short belt life. To determine if center distance variation exists, turn off the drive and tightly tie a piece of string from the driveR to the driveN shaft. Start up the drive and note if the string stretches almost to the point of breaking, or goes slack. If either is the case, the problem could be center distance variation.

It is particularly important to observe the string right at drive start up when the loads are highest. String can also be used to check pulley alignment.

Belt & Sheave Groove Gauges

If a belt-to-sheave groove mismatch is suspected, English and metric belt and sheave groove gauges can be used to check dimensions. These also are handy for identifying a belt cross section for replacements and for checking sheave grooves for wear.

These gauges are available from Gates distributors.

English Gauge:
Product No.
7401-0014
Metric Gauge:
Product No.
7401-0013

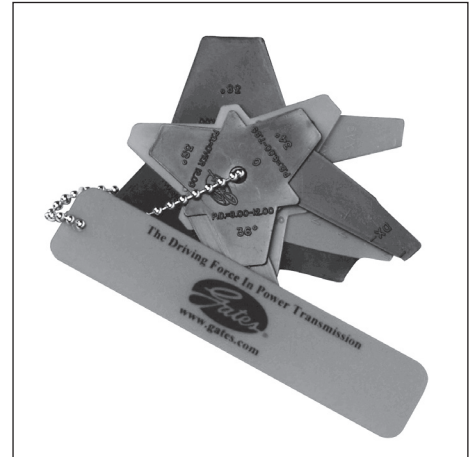

Long Straight Edge

While V-belts can be somewhat forgiving of misalignment, this condition can still affect V-belt performance. Even slight misalignment can cause major problems on a synchronous drive. Use a long straight edge, made of wood, metal or any rigid material, to quickly check drive alignment. Simply lay the straight edge across the pulley faces and note the points of contact (or lack of contact).

Design Flex® Pro™ and Design IQ™ Software

Gates design suite of engineering programs include interactive support software and a user friendly interface for rapid data retrieval and smooth design work.

Both programs are available at www.gates.com/drivedesign.

NOTE: In some cases redesign of the drive is necessary. Gates Design Flex® Pro™ drive design software provides a quick, accurate and flexible method of correctly redesigning problem drives.

On-the-go belt tensioning information is available in our PT Toolkit mobile app. Download today.



MAINTENANCE TOOLS

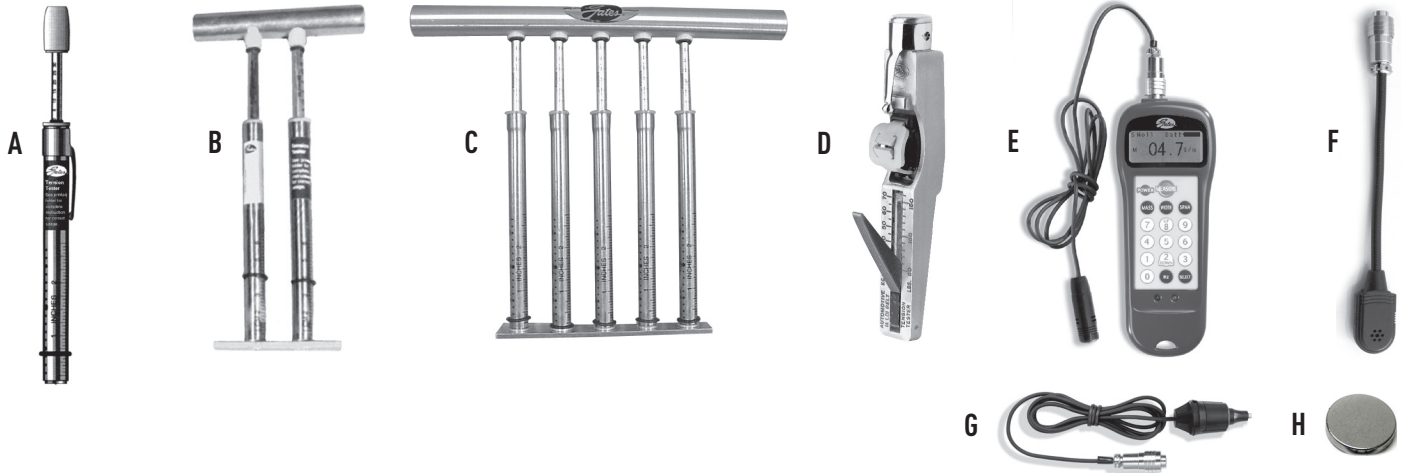

Belt Tension Testers

Improper belt tension, either too high or too low, can cause belt drive problems. An “experienced” thumb may be okay for ordinary drives, but for critical drives, Gates recommends using a tension gauge. Proper tension and installation can extend belt life and reduce costly downtime.

Several types of tension gauges are available.

A. Tension Tester

(Product No. 7401-0076)

Maximum deflection force: 30 lbs.
For use with all small V-belt and Synchronous drives, including PowerBand® and Poly Chain® GT® Carbon™ belt drives.

B. Double Barrel Tension Tester

(Product No. 7401-0075)

Maximum deflection force: 66 lbs.
For use with all multiple V-belt and large Synchronous drives, including PowerBand® and Poly Chain® GT® Carbon™ belt drives.

C. 5-Barrel Tension Tester

(Product No. 7401-0079)

Maximum deflection force: 165 lbs.
for use with multiple V-belt and large Synchronous drives.

D. Kriket Gauge

(Product No. 7401-0071)

For use with Automotive V-belts up to and including 7/8" top width.

Kriket II

(Product No. 7401-0072)

For use with Automotive V-ribbed belts up to 8 ribs in width.

E. Sonic Tension Meter

Model 508C

(Product No. 7420-0508)

For extremely accurate belt tension measuring, the Gates Sonic Tension Meter is an electronic device that measures the natural frequency of a free stationary belt span and instantly computes the static belt tension based upon the belt span length, belt width and belt type.

Features:

- Can be used for synchronous and V-belts.
- Uses sound waves instead of force/deflection.
- Results are repeatable with any operator.
- Portable, lightweight and easy to use.
- Fast. Calculates tension in seconds.
- Can be used in almost any environment.
- Model 508C runs on two AAA batteries.



Accessories:

F. Flexible Sensor

(Product No. 7420-0205)

G. Optional Inductive Sensor

(Product No. 7420-0212)

H. Replacement Magnets for Inductive Sensor

(Prod. No. 7420-1212, set of 10)

I. EZ Align® Laser Alignment Tool

(Product No. 7420-1000

- Red Laser)

(Product No. 7420-3000

- Green Laser)

- Compact design
- Laser projects a line
- Mirror reflects laser line, making it easy to align shafts
- Laser line is very easy to read on targets
- Includes a hard foam filled plastic carrying case
- Green laser is ideal for outdoor or bright environment use



MAINTENANCE TOOLS

Dial Indicator

Improperly mounted sheaves or out-of-round pulleys are sometimes the root of vibration or more severe problems. This device can be used to measure side-to-side sheave wobble or diameter variation by holding it up to the sheave sidewall or top of the belt inside the pulley groove, respectively. **IMPORTANT:** Always turn off the machine before using the dial indicator. Rotate the drive by hand to make your measurements.

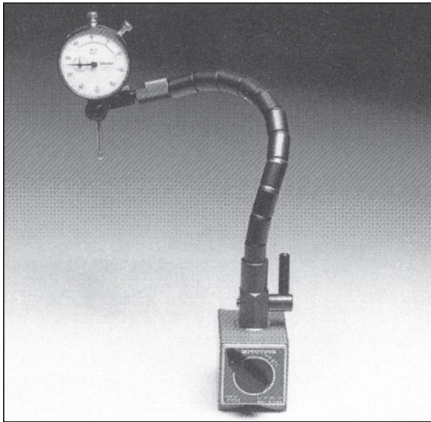

Infrared Pyrometer

The pyrometer accurately measures external belt temperatures and environmental temperatures.



Noise Meter

Use a noise meter to measure environmental and belt drive noise.

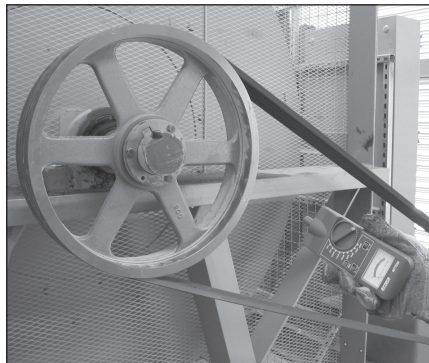

Strobe Tachometer

It is not always possible to see what is happening to a drive while it is in operation. This instrument visually stops the action to get a better idea of the dynamic forces affecting the drive. The strobe tachometer is best used after initial diagnosis of the problem because it helps pinpoint the cause. It will help identify such things as single or dual mode belt span vibration and frame flexure.



TECHNICAL INFORMATION

Table No. 1

Heavy-Duty V-Belt Section, Sheave Diameters and Standard Groove Angles

Belt Section	Sheave Datum Diameter (D.D.) (in)	Standard Groove Angle (± 0.20°)
A, AX	Up to 5.40	34
A, AX	Over 5.40	38
B, BX	Up to 7.00	34
B, BX	Over 7.00	38
C, CX	Up to 7.99	34
C, CX	8.00 to 12.00	36
C, CX	Over 12.00	38
D	Up to 12.99	34
D	13.00 to 17.00	36
D	Over 17.00	38
E	Up to 24.00	36
E	Over 24.00	38
3V, 3VX	Up to 3.49	36
3V, 3VX	3.50 to 6.00	38
3V, 3VX	6.00 to 12.00	40
3V, 3VX	Over 12.00	42
5V, 5VX	Up to 9.99	38
5V, 5VX	10.00 to 16.00	40
5V, 5VX	Over 16.00	42
8V	Up to 15.99	38
8V	16.00 to 22.40	40
8V	Over 22.40	42

Table No. 2

Maximum Allowable Outside Diameters For Cast Iron Pulleys

Maximum Shaft Speed (RPM)	Maximum Allowable Pulley Diameter (in)
600	41.40
870	28.50
1,160	21.40
1,400	17.70
1,600	15.50
1,750	14.20
2,000	12.40
2,400	10.30
2,800	8.80
3,000	8.30
3,450	7.20
4,000	6.20
4,500	5.50
5,000	5.00
7,500	3.31
10,000	2.48

Table No. 3

Standard Shaft and Bushing Keyseat Dimensions

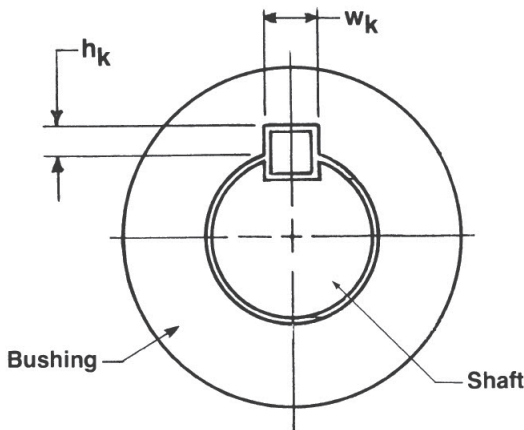

Shaft Diameter (in)	Width w_k (in)*	Depth h_k +0.015-0.000 (in)
Up Through 7/16 (0.44)	3/32 (0.094)	3/64 (0.047)
Over 7/16 (0.44) To and Incl. 9/16 (0.56)	1/8 (0.125)	1/16 (0.062)
Over 9/16 (0.56) To and Incl. 7/8 (0.88)	3/16 (0.188)	3/32 (0.094)
Over 7/8 (0.88) To and Incl. 1 1/4 (1.25)	1/4 (0.250)	1/8 (0.125)
Over 1 1/4 (1.25) To and Incl. 1 3/8 (1.38)	5/16 (0.312)	5/32 (0.156)
Over 1 3/8 (1.38) To and Incl. 1 3/4 (1.75)	3/8 (0.375)	3/16 (0.188)
Over 1 3/4 (1.75) To and Incl. 2 1/4 (2.25)	1/2 (0.500)	1/4 (0.250)
Over 2 1/4 (2.25) To and Incl. 2 3/4 (2.75)	5/8 (0.625)	5/16 (0.312)
Over 2 3/4 (2.75) To and Incl. 3 1/4 (3.25)	3/4 (0.750)	3/8 (0.375)
Over 3 1/4 (3.25) To and Incl. 3 3/4 (3.75)	7/8 (0.875)	7/16 (0.438)
Over 3 3/4 (3.75) To and Incl. 4 1/2 (4.50)	1 (1.000)	1/2 (0.500)
Over 4 1/2 (4.50) To and Incl. 5 1/2 (5.50)	1 1/4 (1.250)	5/8 (0.625)
Over 5 1/2 (5.50) To and Incl. 6 1/2 (6.50)	1 1/2 (1.500)	3/4 (0.750)
Over 6 1/2 (6.50) To and Incl. 7 1/2 (7.50)	1 3/4 (1.750)	3/4 (0.750)
Over 7 1/2 (7.50) To and Incl. 9 (9.00)	2 (2.000)	3/4 (0.750)
Over 9 (9.00) To and Incl. 11 (11.00)	2 1/2 (2.500)	7/8 (0.875)
Over 11 (11.00) To and Incl. 13 (13.00)	3 (3.000)	1 (1.000)

*Tolerance on Width, w_k for widths up through 1/2" (0.500) +0.002-0.000
 For widths over 1/2" (0.500) through 1" (1.000) +0.003-0.000
 For widths over 1" (1.000) +0.004-0.000



NEMA MINIMUM DIAMETERS

Electric Motor Frames and Minimum Sheave and Sprocket Diameters

Table No. 4

The National Electric Manufacturers Association (NEMA) publishes recommendations for the minimum diameter of sheaves to be used on General Purpose electric motors. Purpose of the recommendations is to prevent the use of too small sheaves, which can result in shaft or bearing damage because belt pull goes up as sheave diameter goes down.

The NEMA Standard MG-1-14.42, November 1978 shows minimum recommended sheave diameters as a function of frame number. The table below lists the NEMA frame assignments and minimum diameter recommendations according to the 1964 rerating program.

Motor Frame Code	Shaft Diameter (in)	Horsepower at Synchronous Speed (rpm)				Synchronous Belts
		3600 (3450)	1800 (1750)	1200 (1160)	900 (870)	Minimum Pitch Diameter (in)
143T	0.875	1-1/2	1	3/4	1/2	2.0
145T	0.875	2 - 3	1-1/2 - 2	1	3/4	2.2
182T	1.125	3	3	1-1/2	1	2.2
182T	1.125	5	—	—	—	2.4
184T	1.125	—	—	2	1-1/2	2.2
184T	1.125	5	—	—	—	2.2
184T	1.125	7-1/2	5	—	—	2.7
213T	1.375	7-1/2-10	7-1/2	3	2	2.7
215T	1.375	10	—	5	3	2.7
215T	1.375	15	10	—	—	3.4
254T	1.625	15	—	7-1/2	5	3.4
254T	1.625	20	15	—	—	4.0
256T	1.625	20-25	—	10	7-1/2	4.0
256T	1.625	—	20	—	—	4.0
284T	1.875	—	—	15	10	4.0
284T	1.875	—	25	—	—	4.0
286T	1.875	—	30	20	15	4.7
324T	2.125	—	40	25	20	5.4
326T	2.125	—	50	30	25	6.1
364T	2.375	—	—	40	30	6.1
364T	2.375	—	60	—	—	6.7
365T	2.375	—	—	50	40	7.4
365T	2.375	—	75	—	—	7.7
404T	2.875	—	—	60	—	7.2
404T	2.875	—	—	—	50	7.6
404T	2.875	—	100	—	—	7.7
405T	2.875	—	—	75	60	9.0
405T	2.875	—	100	—	—	7.7
405T	2.875	—	125	—	—	9.5
444T	3.375	—	—	100	—	9.0
444T	3.375	—	—	—	75	8.6
444T	3.375	—	125	—	—	9.5
444T	3.375	—	150	—	—	9.5
445T	3.375	—	—	125	—	10.8
445T	3.375	—	—	—	100	10.8
445T	3.375	—	150	—	—	10.8
445T	3.375	—	200	—	—	11.9

For other than the General Purpose AC motors (for example, DC motors, Definite Purpose motors, motors with special bearings or motors that are larger than those covered by the NEMA standard), consult the motor manufacturer for minimum sheave diameter recommendations. It is helpful to the manufacturer to include details of the application with your inquiry.

NEMA MINIMUM DIAMETERS

Minimum Recommended Sprocket Outside Diameters for General Purpose Electric Motors

Data in the white area are from NEMA Standard MG-1-14-42, June 1972. Figures in black area are from MG-1-43, January 1968. The gray area is a composite of electric motor manufacturer data. They are generally conservative and specific motors and bearings may permit the use of a smaller motor sprocket. Consult the motor manufacturer.

NOTE: For a given horsepower and speed, the total belt pull is related to the motor sprocket size. As the size **decreases**, the total belt pull **increases**. Therefore, to limit the resultant load on motor and shaft bearings, NEMA lists minimum sprocket sizes for the various motors. The sprocket on the motor (DriveR sprocket) should be at least this large.

NEMA Minimum Sprocket Diameters

Motor Horsepower	Motor RPM (60 Cycle and 50 Cycle Electric Motors)						Motor Horsepower
	575 485*	690 575*	870 725*	1160 950*	1750 1425*	3450 2850*	
1/2	-	-	2.0	-	-	-	1/2
3/4	-	-	2.2	2.0	-	-	3/4
1	2.7	2.3	2.2	2.2	2.0	-	1
1-1/2	2.7	2.7	2.2	2.2	2.2	2.0	1-1/2
2	3.4	2.7	2.7	2.2	2.2	2.2	2
3	4.1	3.4	2.7	2.7	2.2	2.2	3
5	4.1	4.1	3.4	2.7	2.7	2.2	5
7-1/2	4.7	4.1	4.0	3.4	2.7	2.7	7-1/2
10	5.4	4.7	4.0	4.0	3.4	2.7	10
15	6.1	5.4	4.7	4.0	4.0	3.4	15
20	7.4	6.1	5.4	4.7	4.0	4.0	20
25	8.1	7.4	6.1	5.4	4.0	4.0	25
30	9.0	8.1	6.1	6.1	4.7	-	30
40	9.0	9.0	7.4	6.1	5.4	-	40
50	9.9	9.0	7.6	7.4	6.1	-	50
60	10.8	9.9	9.0	7.2	6.7	-	60
75	12.6	11.7	8.6	9.0	7.7	-	75
100	16.2	13.5	10.8	9.0	7.7	-	100
125	18.0	16.2	13.5	10.8	9.5#	-	125
150	19.8	18.0	16.2	11.7	9.5	-	150
200	19.8	19.8	19.8	-	11.9	-	200
250	19.8	19.8	-	-	-	-	250
300	24.3	24.3	-	-	-	-	300

Table No. 5

*These RPM are for 50 cycle electric motors. # Use 8.6 for Frame Number 444 T only.

NEMA Minimum V-Belt Sheave Diameters

Table No. 6

Minimum Recommended Sheave Outside Diameters for General Purpose Electric Motors
Super HC® V-Belts, Super HC PowerBand® Belts,
Polyflex® JB® Belts.

Motor Horse- power	Motor RPM (60 cycle and 50 cycle Electric Motors)						Motor Horse- power
	575 485*	690 575*	870 725*	1160 950*	1750 1425*	3450 2850	
1/2	—	—	2.2	—	—	—	1/2
3/4	—	—	2.4	2.2	—	—	3/4
1	3.0	2.5	2.4	2.4	2.2	—	1
1 1/2	3.0	3.0	2.4	2.4	2.4	2.2	1 1/2
2	3.8	3.0	3.0	2.4	2.4	2.4	2
3	4.5	3.8	3.0	3.0	2.4	2.4	3
5	4.5	4.5	3.8	3.0	3.0	2.4	5
7 1/2	5.2	4.5	4.4	3.8	3.0	3.0	7 1/2
10	6.0	5.2	4.4	4.4	3.8	3.0	10
15	6.8	6.0	5.2	4.4	4.4	3.8	15
20	8.2	6.8	6.0	5.2	4.4	4.4	20
25	9.0	8.2	6.8	6.0	4.4	4.4	25
30	10.0	9.0	6.8	6.8	5.2	—	30
40	10.0	10.0	8.2	6.8	6.0	—	40
50	11.0	10.0	8.4	8.2	6.8	—	50
60	12.0	11.0	10.0	8.0	7.4	—	60
75	14.0	13.0	9.5	10.0	8.6	—	75
100	18.0	15.0	12.0	10.0	8.6	—	100
125	20.0	18.0	15.0	12.0	10.5#	—	125
150	22.0	20.0	18.0	13.0	10.5	—	150
200	22.0	22.0	22.0	—	13.2	—	200
250	22.0	22.0	—	—	—	—	250
300	27.0	27.0	—	—	—	—	300

*These RPM are for 50 cycle electric motors. # 9.5 for Frame Number 444T.

Table No. 7

Minimum Recommended Sheave Datum Diameters for General Purpose Electric Motors
Hi-Power® II V-Belts, Hi-Power II PowerBand Belts
or Tri-Power® Molded Notch V-Belts.

Motor Horse- power	Motor RPM (60 cycle and 50 cycle Electric Motors)						Motor Horse- power
	575 485*	690 575*	870 725*	1160 950*	1750 1425*	3450 2850	
1/2	2.5	2.5	2.2	—	—	—	1/2
3/4	3.0	2.5	2.4	2.2	—	—	3/4
1	3.0	2.5	2.4	2.4	2.2	—	1
1 1/2	3.0	3.0	2.4	2.4	2.4	2.2	1 1/2
2	3.8	3.0	3.0	2.4	2.4	2.4	2
3	4.5	3.8	3.0	3.0	2.4	2.4	3
5	4.5	4.5	3.8	3.0	3.0	2.6	5
7 1/2	5.2	4.5	4.4	3.8	3.0	3.0	7 1/2
10	6.0	5.2	4.6	4.4	3.8	3.0	10
15	6.8	6.0	5.4	4.6	4.4	3.8	15
20	8.2	6.8	6.0	5.4	4.6	4.4	20
25	9.0	8.2	6.8	6.0	5.0	4.4	25
30	10.0	9.0	6.8	6.8	5.2	—	30
40	10.0	10.0	8.2	6.8	6.0	—	40
50	11.0	10.0	9.0	8.2	6.8	—	50
60	12.0	11.0	10.0	9.0	7.4	—	60
75	14.0	13.0	10.5	10.0	9.0	—	75
100	18.0	15.0	12.5	11.0	10.0	—	100
125	20.0	18.0	15.0	12.5	11.5+	—	125
150	22.0	20.0	18.0	13.0	—	—	150
200	22.0	22.0	22.0	—	—	—	200
250	22.0	22.0	—	—	—	—	250
300	27.0	27.0	—	—	—	—	300

*These RPM are for 50 cycle electric motors. † 11.0 for Frame Number 444T.

Data in Tables 5, 6 and 7 are from NEMA Standard MG-1-14.42, MG-1-14.43, MG-1-14.45 and a composite of electric motor manufacturers data. They are generally conservative and specific motors may permit the use of smaller motor sheaves or sprockets. Consult the motor manufacturer.



MINIMUM RECOMMENDED DIAMETERS

Minimum Recommended Sheave Diameter
By Belt Cross Section

Table No. 8

Belt Cross Section	Min Recommended Datum Diameter (Standard Groove) (in)
Classical V-Belts	
AX	2.20
A	3.00
BX	4.00
B	5.40
CX	6.80
C	9.00
D	13.00
E	21.00
Belt Cross Section	Min Recommended Outside Diameter (Standard Groove) (in)
Narrow V-Belts	
3VX	2.20
3V	2.65
5VX	4.40
5V	7.10
8V	12.50
Light Duty V-Belts	
2L	0.8
3L	1.5
4L	2.5
5L	3.5
Micro-V_o Belts	
J	0.8
L	3.00
M	7.00
Polyflex_o JB_o Belts	
3M	0.67
5M	1.04
7M	1.67
11M	2.64

Minimum Recommended Sprocket Sizes
By Belt Cross Section

Table No. 9

Belt Pitch	Min Recommended Sprocket Size (No. of Teeth)
PowerGrip_o Timing	
MXL	12
XL	12
L	12
H	14
XH	18
XXH	18
PowerGrip_o HTD_o	
3M	12
5M	14
8M	22
14M	28
20M	34
PowerGrip_o GT_o2	
2M	12
3M	16
5M	18
8M	22
14M	28
Poly Chain_o GT_o CarbonTM	
8M	22
14M	28
Synchro-Power_o Polyurethane	
MXL	10
XL	10
L	10
H	14
T2.5	12
T5	10
T10	16
T20	15
AT5	12
AT10	18
AT20	18
5mm HTD	10
8mm HTD	16
14mm HTD	28

MINIMUM RECOMMENDED DIAMETERS

Minimum Recommended Idler Diameters By Belt Cross Section

Table No. 10

Belt Cross Section		Minimum Grooved Inside (grooves)	Min. O.D. Flat Inside Idler (in)	Min. O.D. Flat Backside Idler (in)
Classical	A	3.00	2.25	4.25
	B	5.400	3.75	6.00
	C	9.00	5.75	8.50
	D	13.00	7.50	13.50
	E	21.00	19.00	27.30
	AX	2.20	---	4.25
	BX	4.00	---	6.00
	CX	7.00	---	8.50
	AA	3.00	2.25	---
	BB	5.40	3.75	---
	CC	9.00	5.75	---
	Super HC	3V	2.65	---
5V		7.10	---	10.00
8V		12.50	---	17.50
3VX		2.20	---	4.25
5VX		4.40	---	10.00
Predator	CP	9.00	5.75	8.50
	3VP	2.65	---	4.25
	5VP	7.10	---	8.50
	8VP	12.50	---	17.50

Belt Cross Section	Minimum Grooved Inside (grooves)	Min. O.D. Flat Inside Idler (in)	Min. O.D. Flat Backside Idler (in)
MXL PowerGrip Timing	12	1.00	0.50
XL PowerGrip Timing	12	2.50	1.00
L PowerGrip Timing	10	4.75	1.60
H PowerGrip Timing	14	6.38	2.88
XH PowerGrip Timing	18	11.00	6.38
XXH PowerGrip Timing	18	15.75	9.25
2M PowerGrip GT3	12	1.00	0.50
3M PowerGrip GT3 + HTD	12	1.50	0.75
5M PowerGrip GT3 + HTD	14	2.50	1.25
8M PowerGrip GT3 + HTD	22	4.00	2.80
14M PowerGrip GT3 + HTD	28	7.00	6.50
20M PowerGrip HTD	34	10.00	11.00
5M Poly Chain GT Carbon	16	2.50	1.88
8M Poly Chain GT Carbon	25	4.00	3.00
14M Poly Chain GT Carbon	28	7.00	6.50

INSTALLATION AND TENSIONING ALLOWANCES

Minimum Center Distance Allowances for Belt Installation and Takeup

Table No. 11

V-Belt Number	Minimum Center Distance Allowance for Installation (in)						Minimum Center Distance Allowance for Initial Tensioning and Subsequent Takeup (in)
	3V/3VX		5V/5VX		8V		All Cross Sections
	Super HC® V-Belts	Super HC® PowerBand® Belt*	Super HC® V-Belts	Super HC® PowerBand® Belt*	Super HC® V-Belts	Super HC® PowerBand® Belt*	All Types
Up To and Incl. 475	0.5	1.2					1.0
Over 475 To and Incl. 710	0.8	1.4	1.0	2.1			1.2
Over 710 To and Incl. 1060	0.8	1.4	1.0	2.1	1.5	3.4	1.5
Over 1060 To and Incl. 1250	0.8	1.4	1.0	2.1	1.5	3.4	1.8
Over 1250 To and Incl. 1700	0.8	1.4	1.0	2.1	1.5	3.4	2.2
Over 1700 To and Incl. 2000			1.0	2.1	1.8	3.6	2.5
Over 2000 To and Incl. 2360			1.2	2.4	1.8	3.6	3.0
Over 2360 To and Incl. 2650			1.2	2.4	1.8	3.6	3.2
Over 2650 To and Incl. 3000			1.2	2.4	1.8	3.6	3.5
Over 3000 To and Incl. 3550			1.2	2.4	2.0	4.0	4.0
Over 3550 To and Incl. 3750					2.0	4.0	4.5
Over 3750 To and Incl. 5000					2.0	4.0	5.5
Over 5000 To and Incl. 6000					2.0	4.0	6.0

*Also use these figures for individual Super HC V-Belts in deep groove sheaves.

Minimum Center Distance Allowances for Belt Installation and Takeup

Table No. 12

V-Belt Number	Minimum Center Distance Allowance for Installation (in)										Minimum Center Distance Allowance for Initial Tensioning and Subsequent Takeup (in)
	A		B		C		D		E		All Cross Sections
	Hi-Power II and Tri-Power® Molded Notch V-Belts	Hi-Power II PowerBand® Belt*	Hi-Power II and Tri-Power® Molded Notch V-Belts	Hi-Power II PowerBand® Belt*	Hi-Power II and Tri-Power® Molded Notch V-Belts	Hi-Power II PowerBand® Belt*	Hi-Power II and Tri-Power® Molded Notch V-Belts	Hi-Power II PowerBand® Belt*	Hi-Power II V-Belts	Hi-Power II PowerBand® Belt*	All Types
Up To and Incl. 35	0.75	1.20	1.00	1.50							1.00
Over 35 To and Incl. 55	0.75	1.20	1.00	1.50	1.50	2.00					1.50
Over 55 To and Incl. 85	0.75	1.30	1.25	1.60	1.50	2.00					2.00
Over 85 To and Incl. 112	1.00	1.30	1.25	1.60	1.50	2.00					2.50
Over 112 To and Incl. 144	1.00	1.50	1.25	1.80	1.50	2.10	2.00	2.90			3.00
Over 144 To and Incl. 180			1.25	1.80	2.00	2.20	2.00	3.00	2.50	3.40	3.50
Over 180 To and Incl. 210			1.50	1.90	2.00	2.30	2.00	3.20	2.50	3.50	4.00
Over 210 To and Incl. 240			1.50	2.00	2.00	2.50	2.50	3.20	2.50	3.60	4.50
Over 240 To and Incl. 300			1.50	2.20	2.00	2.50	2.50	3.50	3.00	3.90	5.00
Over 300 To and Incl. 390					2.00	2.70	2.50	3.60	3.00	4.00	6.00
Over 390					2.50	2.90	3.00	4.10	3.50	4.40	1.5% of belt length

*Also use these figures for individual Hi-Power II and Tri-Power Molded Notch V-Belts in deep groove sheaves.

INSTALLATION AND TENSIONING ALLOWANCES

Table No. 13
Micro-V® Belts

V-Belt Number	Minimum Center Distance Allowance for Installation (in)			Minimum Center Distance Allowance For Initial Tensioning and Subsequent Takeup (in)
	J	L	M	All Cross Sections
Standard Effective Length (in)				
Up through 20.0	0.4	—	—	0.3
20.1 through 40.0	0.5	—	—	0.5
40.1 through 60.0	0.6	0.9	—	0.7
60.1 through 80.0	0.7	1.0	—	0.9
80.1 through 100.0	0.8	1.2	1.5	1.1
100.1 through 120.0	—	1.2	1.6	1.3
120.1 through 160.0	—	1.4	1.7	1.7
160.1 through 200.0	—	—	1.8	2.2
200.1 through 240.0	—	—	1.9	2.6
240.1 through 300.0	—	—	2.2	3.3
300.1 through 360.0	—	—	2.5	3.9
60.1 through 370.0	—	—	2.7	4.6

Table No. 14
Polyflex® JB® Belts

V-Belt Number	Minimum Center Distance Allowance for Installation (in)				Minimum Center Distance Allowance For Initial Tensioning and Subsequent Takeup (in)
	3M	5M	7M	11M	All Cross Sections
Standard Effective Length (in)					
180-300	.18	0.4	—	—	0.2
307-750	.28	0.6	0.6	1.0	0.6
750-1090	—	0.9	0.9	1.2	1.1
1120-1500	—	1.1	1.1	1.4	1.4
1550-1900	—	—	1.1	1.5	1.4
1950-2300	—	—	1.5	1.9	1.8

Table No. 15

Poly Chain® GT® Carbon™ Installation & Tensioning Allowances

Center Distance Allowance For Installation and Tensioning

Belt Length (mm) (in)	Standard Installation Allowance (Flanged Sprockets Removed for Installation) (mm) (in)	Tensioning Allowance (Any Drive) (mm) (in)
Up to 1000 40	1.8 0.07	0.8 0.03
Over 1000 to 1780 40 to 70	2.8 0.11	0.8 0.03
Over 1780 to 2540 70 to 100	3.3 0.13	1.0 0.04
Over 2540 to 3300 100 to 130	4.1 0.16	1.0 0.04
Over 3300 to 4600 130 to 180	5.3 0.21	1.3 0.05



INSTALLATION AND TENSIONING ALLOWANCES

Table No. 16

Additional Center Distance Allowance for Installation Over Flanged Sprocket*

(Add to Installation Allowance in Above Table)

Belt Pitch (mm) (in)	One Sprocket Flanged (mm) (in)	Both Sprockets Flanged (mm) (in)
8mm	21.8 0.86	33.3 1.31
14mm	31.2 1.23	50.0 1.97

* For drives that require installation of the belt over one sprocket at a time, use the value for both sprockets flanged — even if only one sprocket is flanged.

Table No. 17

Power Grip GT®3 and HTD Center Distance Allowance for Installation and Tensioning

Belt Pitch (mm) (in)	Standard Installation Allowance (Flanged Sprockets Removed for Installation) (mm) (in)	Tensioning Allowance (Any Drive) (mm) (in)
Up to 125 5	0.5 0.02	0.5 0.02
Over 125 to 250 5 to 10	0.8 0.03	0.8 0.03
Over 250 to 500 10 to 20	1.0 0.04	0.8 0.03
Over 500 to 1000 20 to 40	1.8 0.07	0.8 0.03
Over 1000 to 1780 40 to 70	2.8 0.10	0.8 0.04
Over 1780 to 2540 70 to 100	3.3 0.13	1.0 0.04
Over 2540 to 3300 100 to 130	4.1 0.16	1.3 0.05
Over 3300 to 4600 130 to 180	4.8 0.19	1.3 0.05
Over 4600 to 6900 180 to 270	5.6 0.22	1.3 0.05

Table No. 18

Additional Center Distance Allowance for Installation Over Flanged Sprockets*

(Add to Installation Allowance in Above Table)

Belt Pitch (mm) (in)	One Sprocket Flanged (mm) (in)	Both Sprockets Flanged (mm) (in)
5mm	13.5 0.53	19.1 0.75
8mm	21.8 0.86	33.3 1.31
14mm	31.2 1.23	50.0 1.97
20mm	47.0 1.85	77.5 3.05

* For drives that require installation of the belt over one sprocket at a time, use the value for "Both Sprockets Flanged".

INSTALLATION AND TENSIONING ALLOWANCES

Table No. 19

Power Grip® Timing Belts Center Distance Allowance for Installation and Tensioning

Belt Length (in)	Standard Installation Allowance (Flanged Pulleys Removed for Installation) (in)	Tensioning Allowance (Any Drive) (in)
3.6 to 5.0	.02	.02
Over 5.0 to 10.0	.03	.03
Over 10.0 to 20.0	.04	.03
Over 20.0 to 40.0	.05	.04
Over 40.0 to 60.0	.07	.05
Over 60.0 to 180.0	.12"	.08"

Table No. 20

Additional Center Distance Allowance for Installation Over Flanged Pulleys*

(Add to Installation Allowance in Above Table)

Belt Pitch (in)	Small Pulley Flanged (in)	Both Pulleys Flanged (in)
0.080" (MXL)	.33	.49
0.200" (XL)	.46	.71
0.375" (L)	.64	.85
0.500" (H)	.64	.96
0.875" (XH)	1.14	1.92
1.250" (XXH)	1.53	2.65

* For drives that require installation of the belt over one sprocket at a time, use the value for both pulleys flanged — even if only one pulley is flanged.

Table No. 21

Estimating Belt Length from Drive Dimensions

(2 Pulleys)

$\text{Belt Length} = 2C + 1.57(D + d) + \frac{(D - d)^2}{4C}$	
Where: C = Shaft Center Distance	
a.) For Super HC®:	Belt Length = Belt Outside Diameter D = O.D. of Larger Pulley d = O.D. of Smaller Pulley
b.) For Hi-Power® II and Tri-Power® Molded Notch:	Belt Length = Datum Length D = Datum Diameter of Larger Pulley d = Datum Diameter of Smaller Pulley
c.) For Synchronous Belts:	Belt Length = Pitch Length D = Pitch Diameter of Larger Sprocket d = Pitch Diameter of Smaller Sprocket

IDLER HARDWARE

Flat Idler Pulley

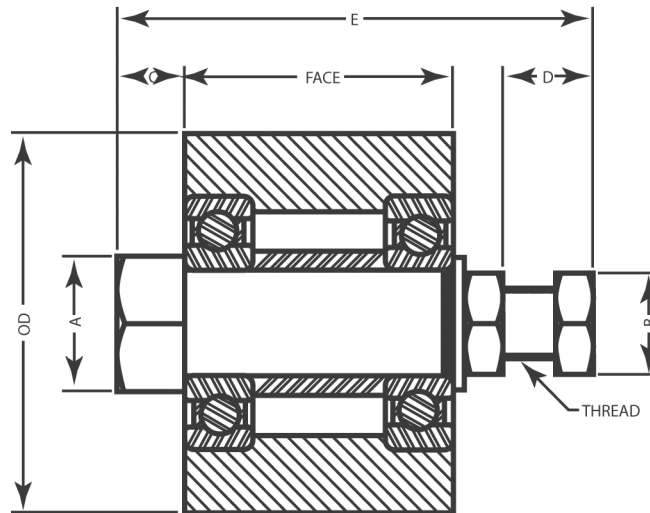

Flat Idler Pulley

Part No.	Product No.	Use With Synchronous Belt		Use With V-Belt	Outside Dia. (in)	Face Width (in)	A (in)	B (in)	C (in)	D (in)	E (in)	Thread Size	Bearing No.	Weight (lb)
		Pitch	Width											
4.25x1.25-IDL-FLAT	7723-4125	8mm, L, H	Up to 21mm (0.85")	1-2 Strand 3V/3VX, 1 Strand A/AX	4.25	1.25	1.13	1.13	.64	1.30	3.75	3/4-16	6304	5.20
4.25x1.25-IDL-FLAT	7723-4200	8mm, L, H	Up to 38mm (1.5")	3-4 Strand 3V/3VX, 2 Strand A/AX	4.25	2.00	1.50	1.13	.63	1.32	4.50	3/4-16	6306	7.50
4.25x1.25-IDL-FLAT	7723-4300	8mm, L, H	Up to 62mm (2.4")	5-6 Strand 3V/3VX, 3 Strand A/AX	4.25	3.00	1.50	1.13	.75	1.32	5.63	3/4-16	6306	10.60
4.25x1.25-IDL-FLAT	7723-4400	8mm, L, H	Up to 85mm (3.3")	8 Strand 3V/3VX, 4 Strand A/AX	4.25	4.00	1.50	1.13	.75	1.32	6.63	3/4-16	6306	13.60
6.50x1.75-IDL-FLAT	7723-6175	14mm	Up to 20mm	1 Strand B/BX	6.50	1.75	2.00	1.50	1.04	1.96	5.69	1-14	6308	17.10
6.50x2.75-IDL-FLAT	7723-6275	14mm	Up to 55mm	2-3 Strand B/BX	6.50	2.75	2.00	1.50	.13	2.10	5.69	1-14	6308	23.00
6.50x4.25-IDL-FLAT	7723-6425	14mm	Up to 90mm	4-5 Strand B/BX	6.50	4.25	2.38	1.50	.13	1.98	7.06	1-14	6308	33.00
6.50x5.75-IDL-FLAT	7723-6575	14mm	Up to 125mm	6 Strand B/BX	6.50	5.75	2.38	1.50	.99	1.98	9.31	1-14	6308	45.00
6.50x7.50-IDL-FLAT	7723-6750	14mm	Up to 170mm	8 Strand B/BX	6.50	7.50	2.38	1.50	1.00	1.98	11.19	1-14	6308	57.01

Idler Bushings

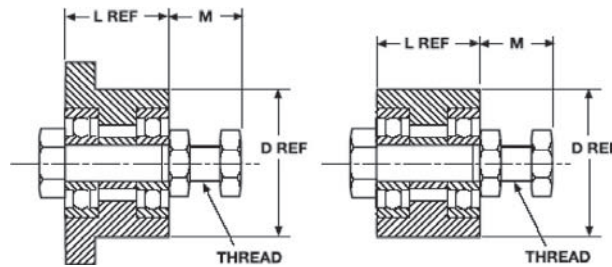

Idler Bushings

Part No.	Product No.	Style	Size	D (in)	L (in)	M (in)	Thread Size	Bearing No.	Weight (lb)
20-IDLR-BUSH(SK)	7720-1120	20	SK	2.81	1.94	1.44	3/4-16	6304	11.00
30-IDLR-BUSH(SF)	7720-1130	20	SF	3.13	2.08	2.13	1-14	6206	8.60
40-IDLR-BUSH(E)	7720-1140	20	E	3.83	2.75	2.19	1-14	6306	8.62
1610-IDLR-BUSH	7720-2610	20	1610	2.25	1.00	1.38	5/8-18	6003	1.30
2012-IDLR-BUSH	7720-2012	20	2012	2.75	1.25	1.56	3/4-16	6204	2.30
2517-IDLR-BUSH	7720-2517	20	2517	3.38	1.75	1.56	3/4-16	6304	3.90

IDLER HARDWARE

Idler Sprockets

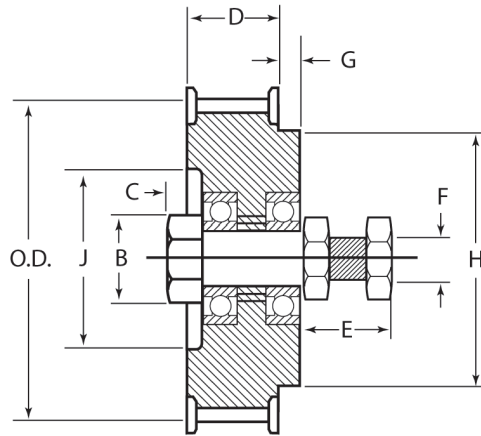

Poly Chain® GT® Carbon™ Idler Sprocket

Part No.	Product No.	Use With	Belt Width (in)	Number of Teeth	Pitch Diameter (in)	B (in)	C (in)	D (in)	E (in)	F Threads (in)	G (in)	H (in)	J (in)	Bearing No.	Weight (lb)
12-IDL-SPRK	7720-1500	8mm Pitch	12	32	3.208	1.25	.50	.85	1.56	3/4-16	.94	2.75	—	6304	3.80
20-IDL-SPRK	7720-1600	14mm Pitch	20	30	5.263	2.55	1.00	1.36	2.25	1-14	1.00	4.38	—	6308	12.55
21-IDL-SPRK	7720-1510	8mm Pitch	21	32	3.208	1.25	.50	1.24	1.56	3/4-16	.56	2.75	—	6304	3.88
36-IDL-SPRK	7720-1520	8mm Pitch	36	36	3.609	1.91	.75	1.86	1.63	3/4-16	—	—	—	6306	5.14
37-IDL-SPRK	7720-1610	14mm Pitch	37	30	5.236	2.55	1.00	2.06	2.25	1-14	.25	4.38	—	6308	13.46
62-IDL-SPRK	7720-1530	8mm Pitch	62	36	3.609	1.91	.75	2.91	1.63	3/4-16	.69	3.13	—	6306	9.69
68-IDL-SPRK	7720-1620	14mm Pitch	68	34	5.965	3.38	.56	3.33	2.25	1-14	1.00	4.88	4.34	6310	26.03
90-IDL-SPRK	7720-1640	14mm Pitch	90	34	5.965	3.38	.31	4.20	2.25	1-14	1.00	4.88	4.34	6310	32.18
125-IDL-SPRK	7720-1630	14mm Pitch	125	34	5.965	3.38	.19	5.63	2.25	1-14	1.09	4.88	4.34	6310	36.45

IDLER HARDWARE

Flat Idler Pulley

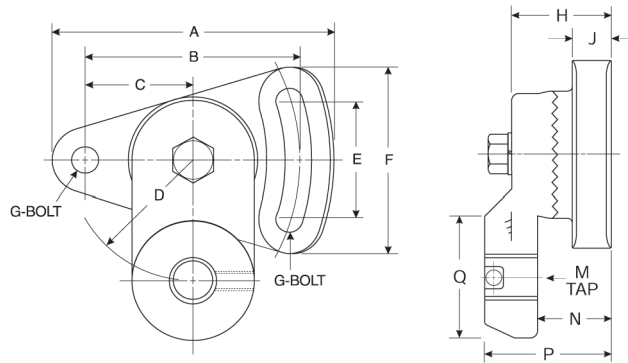

Idler Brackets

Part No.	Product No.	Use With	A (in)	B (in)	C (in)	D (in)	E (in)	F (in)	G (in)	H (in)	J (in)	M Threads (in)	N (in)	P (in)	Q (in)	Weight (lb)
5-IDL-BRAK	7720-1005	1610-IDL-BUSH	4.62	3.50	1.75	2.00	2.06	3.06	.38	1.63	.62	5/8-18	1.16	1.77	1.94	2.80
10-IDL-BRAK	7720-1010	8mm Pitch Idler Sprockets, 4.25" OD Flat Idler Pulleys, 2012-IDL-BUSH, 2517-IDL-BUSH, 20-IDL-BUSH (SK)	4.63	3.50	1.75	2.00	2.06	3.06	.38	1.50	.63	3/4-16	1.00	1.88	1.75	3.40
20-IDL-BRAK	7720-1020	14mm Pitch Idler Sprockets, 6.50" OD Flat Idler Pulleys, 30-IDL-BUSH (SF), 40-IDL-BUSH (E)	6.94	5.25	2.63	5.00	3.00	4.56	.63	2.38	1.00	1-14	1.63	2.94	2.75	11.20

Nickel Plated Idler Brackets

Part No.	Product No.	Use With	A (in)	B (in)	C (in)	D (in)	E (in)	F (in)	G (in)	H (in)	J (in)	M Threads (in)	N (in)	P (in)	Q (in)	Weight (lb)
NP-10-IDL-BRACKET	7720-1011	8mm Pitch Idler Sprockets 2012-IDL-BUSH, 2517-IDL-BUSH, 20-IDL-BUSH (SK)	4.63	3.50	1.75	2.00	2.06	3.06	.38	1.50	.56	3/4-16	1.00	1.88	1.75	3.40
NP-20-IDL-BRACKET	7720-1021	14mm Pitch Idler Sprockets, 30-IDL-BUSH (SF), 40-IDL-BUSH (E)	6.94	5.25	2.63	5.00	3.00	4.56	.63	2.38	1.00	1-14	1.63	2.94	2.75	11.20

DRIVE SURVEY WORKSHEET

High Speed Drive Survey and Energy Savings Worksheet

CUSTOMER INFORMATION

Distributor _____

Customer _____

DRIVE INFORMATION

I.D. of Drive (location, number, etc.) _____

Description of DriveN Equipment _____

Manufacturer of DriveN Equipment _____

Horsepower Rating of Motor _____ DriveN HP Load (Peak) _____ (Normal) _____

Motor Frame Size _____ Motor Shaft Dia. _____ DriveN Shaft Dia. _____

Speed:

DriveR RPM _____ RPM Measured with Contact or Strobe Tachometer Yes No

DriveN RPM _____ RPM Measured with Contact or Strobe Tachometer Yes No

Speed Ratio _____ Speed Up _____ or Speed Down _____

Center Distance: Minimum _____ Nominal _____ Maximum _____

Existing Drive Components: DriveR _____ DriveN _____

Belts _____ Belt Manufacturer _____

Ambient Conditions:

Temperature _____ Moisture _____ Oil, etc. _____

Abrasives _____ Shock Load _____

Static Conductivity Required? Yes No

Maximum Sprocket Diameter (OD) and Width Limitations (for guard clearance):

DriveR: Max. OD _____ Max. Width _____ DriveN: Max. OD _____ Max. Width _____

Guard Description _____

Motor Mount:

Double Screw Base? Yes No Motor Mounted on Sheet Metal? Yes No

Adequate Structure? Yes No Floating/Pivot Motor Base? Yes No

Start Up Load:

%Motor Rating at Start Up _____ AC Inverter? Yes No Soft Start? Yes No

Duty Cycle:

Number of Starts/Stops _____ times per _____ (hour, day, week, etc.)

ENERGY SAVINGS INFORMATION

Energy Cost per KW-Hour _____

Hours of Operation: _____ Hours per Day _____ Days per Week _____ Weeks per Year



DRIVE SURVEY WORKSHEET

Low Speed Drive Design Information Sheet For Drive Selections with Shaft Speeds Less Than 500 rpm

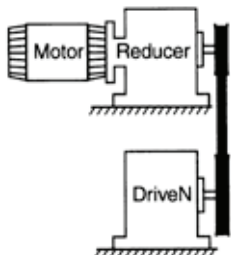
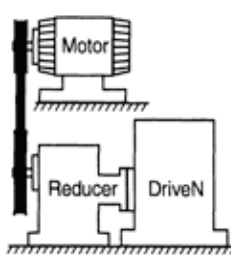
<p>Distributor: _____</p> <p>Customer: _____</p> <p>Drive Identification (location, number, etc.) _____</p> <hr/> <p>DriveR Information:</p> <p>Motor Nameplate Data</p> <p>Rated Horsepower = _____ Rated RPM = _____ Efficiency = _____</p> <p>Rated Voltage = _____ Rated Amps = _____ Rated Torque = _____</p> <p>Actual Motor Load = _____</p> <p>Motor Type: AC <input type="checkbox"/> DC <input type="checkbox"/> Gear Motor <input type="checkbox"/></p> <p>Output Speed: Constant <input type="checkbox"/> Variable <input type="checkbox"/></p> <hr/> <p>Reducer Information:</p> <p>Reducer Type (worm, right angle helical, cycloidal, etc): _____</p> <p>Reducer Efficiency = _____ Output RPM = _____ Reducer Ratio = _____</p> <p>Rated Input HP/Torque = _____ Rated Output HP/Torque = _____</p> <hr/> <p>Existing Drive Information:</p> <p>Drive Type: Chain <input type="checkbox"/> V-Belt <input type="checkbox"/> Synchronous Belt <input type="checkbox"/></p> <p>If chain, type; 2/#60. #80, etc. _____ Lubed <input type="checkbox"/> Unlubed <input type="checkbox"/></p> <p>Current Drive Service Life = _____</p> <p>DriveR Sprocket/Sheave = _____ (teeth/OD) DriveR Shaft Diameter = _____</p> <p>DriveN Sprocket/Sheave = _____ (teeth/OD) DriveN Shaft Diameter = _____</p> <p>Center Distance = _____ + _____ - _____</p> <p>Type of Center Distance Adjustment: _____</p> <p>Idler used: Yes <input type="checkbox"/> No <input type="checkbox"/> Inside <input type="checkbox"/> Backside <input type="checkbox"/></p> <hr/> <p>DriveN Information:</p> <p>Type of Equipment: _____ Actual Horsepower Required = _____</p> <p>DriveN RPM = _____</p> <p>Hours/Day = _____ Days/Week = _____ Weeks/Year = _____</p> <hr/> <p>Special Requirements:</p> <p>Space Limitations:</p> <p>Maximum DriveR Dia. = _____ Maximim DriveN Dia = _____</p> <p>Maximum DriveR Width = _____ Maximum DriveN Width = _____</p> <p>Environmental Conditions:</p> <p>Temperature Range = _____ Belt Conductivity Required <input type="checkbox"/></p> <p>Oil Mist <input type="checkbox"/> Oil Splash <input type="checkbox"/> Moisture <input type="checkbox"/> Abrasives <input type="checkbox"/></p>	<p>Drive Layout (check one)</p> <p><input type="checkbox"/> Motor Reducer Belt Drive Driven</p>  <p><input type="checkbox"/> Motor Belt Drive Reducer Driven</p> 
<p>Belt Drive on Reducer Output Shaft</p>	<p>Belt Drive on Reducer Input Shaft</p>

DRIVE SURVEY WORKSHEET

Gates Design IQ Data Worksheet

Account: _____ Contact: _____
 Address: _____ Title: _____
 _____ Phone: _____ Fax: _____
 _____ E-mail: _____

Application Summary

General Description: _____
 Product Type: _____ Production Volume: _____
 Prototype Schedule: _____ Production Time Schedule: _____

Design Parameters

DriveR:
 Motor Type & Description: _____ (Servo, Stepper, DC, AC, etc.) Reversing: _____ (Y/N)
 Nominal Motor Torque / Power Output: _____ rpm: _____
 Max / Peak Motor Torque/Power Output: _____ rpm: _____
 Motor Stall Torque (If applicable): _____ Driver Rotation: _____ (CW / CCW / Rev)

DriveN's / Idlers: (Specify appropriate units for each field; in, mm / hp, kw / lb-ft, lb-in, N-m, etc.)

Description	X	Y	Pulley Diameter	Pitch	Sprocket Grooves	Inside/ Outside	rpm	Load (driven)	Units	Conditions		Shaft Diameter
										#	% Time	
Driver												

Note: For complex drive layouts use additional pages as needed

Drive Sketch	Idler Details				
<div style="border: 1px solid black; height: 150px; width: 100%;"></div>	Min Position		Max Position		
	X	Y	X	Y	
	Slot Movement: _____		_____		
	Spring: <input type="checkbox"/>				
Pivoting Movement: _____		Pivot Point		Movement Angle	
		X	Y	Min Deg	Max Deg
Spring: <input type="checkbox"/>		Pivot Arm Radius: _____ (in/mm): _____			

Special Requirements

Product Design Life: _____ Belt Life: _____ Hours/Day: _____ Hours/Year: _____
 Pulley Materials: Prototype _____ Production _____
 Belt Construction Considerations:
 Temperature: _____ Moisture: _____ Oil: _____ Static Dissipation: _____ Abrasives: _____
 Special Requirements: _____

TRADEMARKS

- HT100[®], Taper-Lock[®] and Ringfeder[®] are registered trademarks of Reliance Electric.
- Nu-T-Link[®] is a registered trademark of Fenner Manheim.
- QD[®] is a registered trademark of Emerson Electric.
- RPP[®] and Panther[®] are registered trademarks of Carlisle Power Transmission Products, Inc.
- KEVLAR[®] is a registered trademark of E. I. du Pont de Nemours and Company.
- Goodyear[®], BlackHawk PdTM, Poly-V[®] and Flexten[®] are registered trademarks of Goodyear Tire & Rubber Company.
- Browning[®] is a registered trademark of Emerson Power Transmission Manufacturing L.P.
- Dayco[®] is a registered trademark of Dayco Products LLC.
- TB Wood's[®] and QT Power Chain[®] are registered trademarks of T.B. Wood's, Inc.
- Trantorque[®] is a registered trademark of BTL, a subsidiary of Fenner PLC.

WARRANTY

Gates warrants that its power transmission products will be free from defects in materials and workmanship for the life of the product. If the product does not meet this standard, Gates will repair or replace the product free of charge!

Please note that this warranty is customer's exclusive remedy and does not apply in the event of misuse or abuse of the product. Gates disclaims all other warranties (express or implied) including the implied warranties of fitness for a particular purpose and merchantability.

For further details of the Gates Warranty, please see www.gates.com/warranty.

Free design and maintenance resources from Gates:

Design Flex Pro – gates.com/designflex

Design Flex Mobile – gates.com/dfmobile

Design IQ – gates.com/designiq

PT Toolkit Mobile App – gates.com/pttoolkit

Part View eCatalog and CAD library – gates.com/partview

Energy Savings Calculator and other resources – info.gates.com/Preventive-Maintenance

For **Engineering Support** and more, visit gates.com/drivedesign



BELT DRIVE

Preventive Maintenance + Safety

PROPER INSTALLATION + PREVENTIVE MAINTENANCE PROCEDURES

improve workplace safety, reduce downtime, and increase production.

The majority of mechanical power transmission drive problems are attributed to improper component maintenance and installation. This thorough textbook provides in depth guidance to avoid these issues to improve drive performance. Ideal for facility personnel responsible for power transmission equipment, the Gates Belt Drive Preventive Maintenance Manual covers the following topics:

- ▶ **Sources of Drive Problems**
- ▶ **Preventive Maintenance**
- ▶ **Safety**
- ▶ **Drive Inspection**
- ▶ **Installation**
- ▶ **Storage + Handling**
- ▶ **Belt Types + Identification**
- ▶ **Sprocket Corrosion Prevention**
- ▶ **Troubleshooting**

GATES CORPORATION powers progress by providing quality products and expert support to help you increase production, avoid downtime, decrease maintenance, and manage energy costs. Gates invented the V-belt in 1917, and continues to lead the industry with product innovations and unmatched engineering support to improve power transmission efficiency, reliability, and economy.

Gates offers onsite Preventive Maintenance training. To schedule training or to learn more, contact an authorized Gates distributor.

