



WEATHERLY NO. 400  
CATALOG NO. AUTOMOTIVE 431-2080  
INDUSTRIAL 35093  
EDITION 2019  
SUPERSEDES 431-2080 (2014)  
35093 (2015)



# HYDRAULIC & FLEET HOSE PRODUCTS





- A 3,000 psi coupling on a 3,000 psi hose doesn't always equal a 3,000 psi assembly.
- One of the most important and oftentimes overlooked factors in hydraulic hose assembly performance is the hose/coupling interface.
- You can't just design a hose. You can't just design a coupling. You must design a system (a **MegaSystem**).

Unless you have a hose and coupling specifically designed for each other, you may end up with a hose assembly with a lower pressure rating, reduced life, or even worse, a catastrophic failure.

Hose outside diameter and crimp outside diameter are only two of the variables affecting assembly performance.

As variation or tolerances increase even slightly for each component a significant reduction in hose assembly life is guaranteed and the risk for catastrophic failure increases.

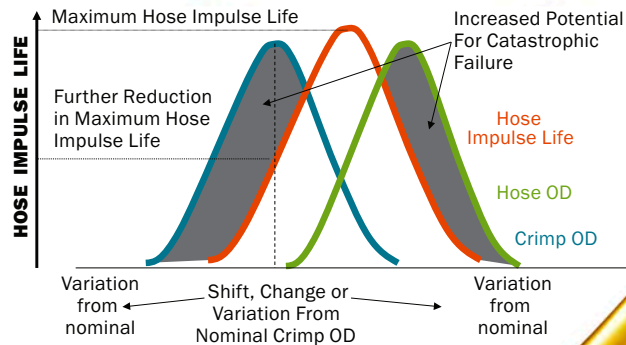
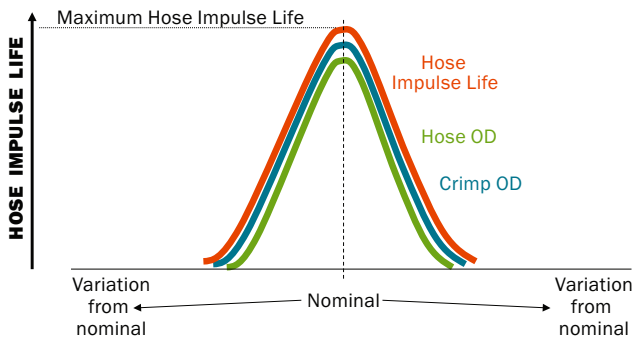

THE NEXT TIME YOU GRAB ANY HOSE AND A COUPLING ASK YOURSELF:

- Who is the manufacturer of these components?
- Have these components been designed together?
- Validated together? And if not, what are the risks I am assuming?
- Am I willing to accept an assembly with a guarantee for reduced impulse life and performance?
- Am I willing to risk catastrophic failure?

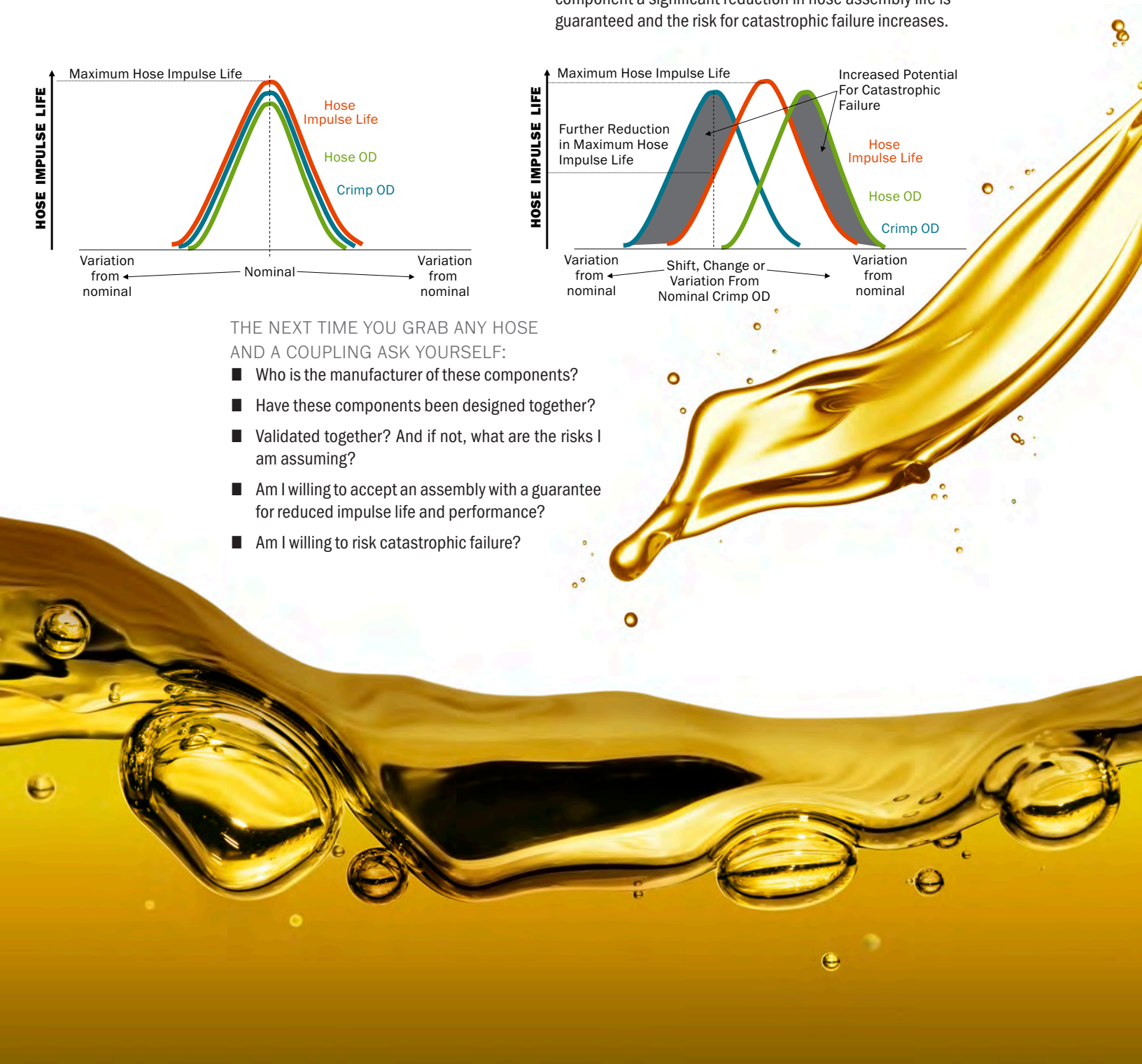



# Avoid injury to yourself and others by following these important hose assembly steps

## WARNING



**Never underestimate the power of a blown hydraulic assembly.**

**Serious injury, death and destruction of property can result from rupture or blow-apart of a hydraulic hose assembly that is:**

- Damaged or worn out
- Assembled or installed incorrectly
- Wrong for application

1. **Receive hands-on training** with Gates recommended equipment.
2. Follow current Gates **operating manuals and crimp data**.
3. Use only new (unused) Gates recommended hose and couplings **with Gates crimpers**.
4. **Wear safety glasses.**

### Select and Install Assemblies With Care

1. **Select proper hose assemblies for the application.** Many factors and conditions affecting the inside and outside diameter of the hose must be taken into account.
2. Hose assembly routing **must not** create an injury hazard or damage hose. Refer to the standards, regulations and directories that apply in the countries where the equipment is sold and used.
3. Select hydraulic components so that the application's temperature, pressure and bend radius **do not exceed** recommended component limits.

4. Hose **must not** be stretched, kinked, crushed or twisted during installation or use. Hose **must not** be bent to less than the minimum bend radius.
5. Use **only non-conductive** non-thermoplastic hose for **non-conductive** applications. For instance: cherry pickers. All other Gates hoses are electrically conductive, unless specified otherwise.

**6. DO NOT use standard hydraulic hose to convey gases or steam over 500 PSI. Use only products rated for this service.**

**7. DO NOT use hydraulic hose in place of permanent piping.**

### Follow Good Maintenance Practices

1. **Establish a program** of inspection, testing and replacement of hose assemblies from factors including:
  - Severity of application
  - Frequency of equipment use
  - Past performance of hose assemblies

2. **Only** properly trained persons should inspect, test or service hose assemblies. Update training periodically.

3. **Document** maintenance, inspections and testing.

### 4. AVOID FLUID INJECTION INJURIES

- Fluid under pressure can cause serious injury. It can be almost invisible escaping from a pinhole, and it can pierce the skin into the body.
- Do not touch a pressurized hydraulic hose assembly or attempt to find a hydraulic system leak with any part of your body.
- If fluid punctures the skin, **even if no pain is felt, a serious emergency exists.** Obtain medical assistance immediately. **Failure to do so can result in loss of the injured body part or death.**



5. Stay out of hazardous areas while testing hose assemblies under pressure. **Use proper safety protection.**

## OTHER SAFETY INFORMATION

Many factors affect the selection, crimping, installation and maintenance of hose assemblies. This catalog, Gates Corporation, the hydraulic equipment maker, the Society of Automotive Engineers Recommended Practice SAE J1273 and the International Organization for Standardization Practices for hydraulic hose assemblies ISO 17165-2 have useful information about selecting, crimping,

installing and servicing hydraulic hose assemblies. For further information, please contact your local Gates representative or call Gates Corporation.

Gates recommends hose and coupling combinations in this catalog only after completing extensive testing.

Evaluation of a hose and coupling combination requires considerable impulse testing and cannot

be determined by a simple burst or pressure hold test. Gates disclaims all liability for any hose assembly made in violation of Gates recommendations, procedures and current crimp data. Crimp data is updated on average every year. For the most up-to-date crimp data, visit our website at [www.gates.com/ecrimp](http://www.gates.com/ecrimp).

The consumer's exclusive remedy with respect to any claim shall be a refund of the purchase price or replacement of the product at the option of Gates. In no event shall Gates be liable for any incidental or consequential damages whatsoever.

# TABLE OF CONTENTS



**MegaSys® Hydraulic Hose** ..... A4 - A8

**MXT™ Hose** ..... A9

**Multi Master GMV MegaFlex and Industrial Hose**... A10

**Abrasion-Resistant Covers**..... A11

**Couplings** ..... A12 - A14

**LifeGuard® Line-of-Sight Sleeving System** ..... A15

**Training Opportunities**..... A16

**Website and International Symbols** ..... A17

**Hydraulic Hose and Assemblies Service Life** ..... A18

**Hose Specification Tables**

    Spiral Wire ..... A19 - A31

    Wire Braid ..... A32 - A54

    Thermoplastic..... A54 - A60

    Transfer ..... A61 - A64

    Return ..... A64 - A67

    Lock-On..... A67 - A70

    Fleet..... A70 - A84

    Specialty..... A85 - A87

    Industrial Hose ..... A87 - A101

**Equipment** ..... B1 - B22

**Selecting the Proper Hose**..... C1 - C2

**Characteristics of Hose Stock Types**..... C3

**Gates Hydraulic Hose Selection Guide**..... C4 - C6

**Additional Temperature Limits for Gates Hydraulic Hose**..... C7

**Type Approval and Hose Selection Guide** ..... C8

**SAE Recommended Practices for Hydraulic Hose Assemblies**..... C9 - C11

**Motor Vehicle Safety Standard for Brake Hose**... C12

**How to Make Hose Assemblies of Specific Lengths**.. C13

**How to Describe Gates Hydraulic Hose Assemblies**.. C14 - C15

**Hose Assembly Routing Tips**..... C16 - C17

**Installation of LifeGuard® Line-of-Sight Sleeving** .. C18

**Coupling Selection**..... C19 - C21

**Sealing Types for Hydraulic Couplings** ..... C22 - C24

**Coupling/Thread Identification Tools**..... C25 - 26

**Thread Chart** ..... C27

**Coupling Identification** ..... C28 - C43

**Gates Global Part Numbering System**..... C44 - C53

**Coupling/Thread Configurations** ..... C54 - C58

**Chemical Resistance Ratings** ..... C59

**Chemical Resistance Table**..... C60 - C68

**Nomographic Chart** ..... C69

**Properties of C14 PTFE Tube**..... C70

**Electrostatic Discharge**..... C71

**Effusion/Corrosion for PTFE Hose and Hose Assemblies** ..... C72

**Hydraulic System Pressure Drop** ..... C73

**Fahrenheit-Celsius Conversion** ..... C74

**Conversions**..... C75 - C76

WEATHERLY NO.	400
CATALOG NO.	AUTOMOTIVE 431-2080 INDUSTRIAL 35093
EDITION	2019
SUPERSEDES	431-2080 (2014) 35093 (2015)

**Tightening and Torque Recommendations for Hydraulic Couplings** ..... C77

**Coupling and Adapter Installation Torque Recommendations** ..... C78

**G8K Couplings**..... D1 - D3

**GlobalSpiral™ Couplings**

    GlobalSpiral™ Couplings ..... E1 - E50

    GlobalSpiral™ Plus Couplings (GSP)..... E51 - E67

    GlobalSpiral™ MAX Pressure Couplings (GSM).. E68 - E84

**Stainless Steel Spiral Couplings** ..... F1 - F6

**MegaCrimp® Couplings** ..... G1 - G55

**Stainless Steel Braid Couplings** ..... H1 - H7

**Power Crimp® Couplings**..... I1 - I9

**Field Attachable G1 and G2 Couplings** ..... J1 - J8

**Field Attachable C5 Couplings**

    Field Attachable for C5CXH, C5C, C5D & C5M Hose ..... K1 - K13

    Field Attachable for C5E Hose ..... K14 - K21

**C14 Couplings** ..... L1 - L11

**GL Couplings** ..... M1 - M10

**GLX® Couplings** ..... N1 - N5

**PCTS Thermoplastic Couplings** ..... O1 - O3

**PolarSeal® (ACA) Couplings**..... P1 - P41

**PolarSeal® II (ACC) Couplings**..... Q1 - Q15

**PolarSeal® II (ACB) Couplings**..... R1 - R31

**Power Steering Couplings**..... S1

**Adapters**

    SAE to SAE..... T1 - T48

    SAE to SAE - High Pressure ..... T49 - T56

    British to SAE..... T57 - T69

    Metric Conversion..... T70 - T75

    International to International ..... T76 - T82

    Japanese Conversion..... T83 - T86

    Ermeto..... T87 - T88

**Quick Disconnect Couplers**

    G940 Series (Agriculture Standard-Ball Valve) .. U1 - U2

    G940 and G941 Series (Agricultural) ..... U3

    G941 Series (Agriculture Standard-Poppet Valve). U4

    G942 Series (John Deere Old Style)..... U5

    G943 Series (International Harvester Old Style)U6

    G944 Series (J.I. Case Old Style) ..... U7





G945 Series (Industrial ISO 7241-1 - Series B) U8 - U9  
 G949 Series (Flush Face - HTMA)..... U10 - U13  
 G950 Series (Flush Face - High Pressure) ..... U14 - U15  
 G951 Series (Wing Nut) ..... U16 - U17  
 G952 Series (High Pressure Wing Nut)..... U18 - U19  
 G953 Series (Very High Pressure)..... U20  
 G956 Series (Industrial ISO 7241 - Series A).. U21 - U22  
 G959 Series (Agriculture QD Adapters) ..... U23 - U24

**Ball Valves**  
 Two Way Block Style ..... V1 - V2  
 Two Way Round Style Large ID ..... V3  
 Three Way Block Style ..... V4

**Live Swivels**..... W1 - W5

**Assembly Fabrication** ..... X1 - X7

**Accessories**  
 Nylon Protective Sleeve ..... Y1 - Y3  
 Hose Guards ..... Y4 - Y6  
 HeatGuard® ..... Y7 - Y8  
 Gates OE-Style Clamp Collars ..... Y9  
 Vinyl Bend Restrictor..... Y10  
 Flange Fittings ..... Y11 - Y13  
 O-Rings ..... Y14 - Y16  
 Tube Nuts and Sleeves..... Y17 - Y20  
 Diagnostic Equipment..... Y21

**Equipment and Parts**..... Z1 - Z4

**Kits**..... AA1 - AA6

**Air Brake Hose Assemblies**..... AB1 - AB3

**Brass**  
 Air Brake Couplings for Rubber Hose ..... AC1 - AC6  
 Brass Lock-On Field Attachable Couplings  
 for LOC & LOL Hose ..... AC7 - AC15  
 Single Bead..... AC16 - AC20  
 Barb Stem..... AC21 - AC23

**Index**..... i - lii

**GATES CORPORATION LIMITED LIFETIME WARRANTY**

Gates Corporation ("Gates") product is warranted to be free from defects in material or workmanship for the life of the product (or the published recommended replacement interval specified by Gates.) Gates will, at its option, replace or repair any merchandise proved defective in material or workmanship during the warranty period. In no event will Gates honor any warranty claim unless it is notified of the claim within six (6) months of the expiration of the warranty period. This shall be the sole remedy for breach of warranty.

Damage to the product due to abuse, misuse, improper use, inadequate maintenance, or failure to follow published installation, use and service recommendations automatically voids this warranty. For warranty service, please contact the Customer Service Department of Gates Corporation, 1144 15th Street, Suite 1400, Denver, CO 80202

**ALL OTHER WARRANTIES, EXPRESS OR IMPLIED, INCLUDING, BUT NOT LIMITED TO, WARRANTIES OF MERCHANTABILITY OR FITNESS FOR A PARTICULAR PURPOSE, ARE HEREBY EXPRESSLY DISCLAIMED. IN NO EVENT WILL GATES BE LIABLE TO ANY PARTY FOR CONSEQUENTIAL, INCIDENTAL, SPECIAL, EXEMPLARY AND INDIRECT DAMAGES, INCLUDING BUT NOT LIMITED TO LOST PROFITS, REGARDLESS OF WHETHER SUCH DAMAGES WERE REASONABLY FORESEEABLE, OR WHETHER GATES HAD KNOWLEDGE THAT THEY COULD OCCUR.**

Some states do not allow the exclusion or limitation of incidental or consequential damages, and some states do not allow limitations on how long an implied warranty lasts, so the above limitation and exclusion may not apply to you. This warranty gives you specific legal rights, and you may also have other rights which vary from state to state.

**INTERNATIONAL SYMBOLS USED IN CATALOG COLUMN HEADINGS**

DESCR	Description
	<b>Hose/Tube Inside Diameter (I.D.)</b>
	<b>Hose/Tube Outside Diameter (O.D.)</b>
	<b>Thread Size</b>
	<b>Working Pressure (psi)</b>
	<b>Minimum Burst Pressure (psi)</b>
	<b>Minimum Bend Radius</b>
	<b>Vacuum</b>

<b>A</b>	<b>Hose/Tube Diameter</b>
<b>C</b>	<b>Cut-Off</b>
<b>F</b>	<b>Flange Head Thickness</b>
<b>H1</b>	<b>Stem Hex</b>
<b>H2</b>	<b>Nut Hex</b>
<b>L</b>	<b>Length</b>
<b>M</b>	<b>Flange Diameter</b>
<b>T</b>	<b>Drop</b>



**As advanced hydraulic systems are designed and engineered into more and more high-powered, high-pressure equipment, the importance of high-quality, flexible, durable hose assemblies that won't fail has never been more critical.**

As the industry leader in hydraulic hose technology, Gates has developed an integrated solution to meet the expanding needs of today's hydraulic systems – and tomorrow's.

Gates MegaSys® hydraulic hose and coupling products offer a combination of technology, performance and flexibility that is unmatched by anything on the market today – or for the foreseeable future!

The fully integrated MegaSys hose line is designed to provide maximum flexibility and performance in a wide range of high-pressure hydraulic applications while simplifying hose selection and assembly fabrication.

MegaSys products and features save time, space and money. Color-coded laylines and constant pressure ratings through all sizes make hose identification and selection easier and faster while reducing inventory requirements. Couplings provide leak-free performance. A bend radius up to one-third the SAE specification enables use of shorter hose lengths and savings of up to 64%. It all adds up to more value for your money.

## CONSTANT PRESSURE HOSE

The MegaSys® line consists of constant pressure spiral-wire and wire-braid hose that can be bent up to one-third SAE specifications. Combined with innovative couplings specifically designed to crimp on these hose, leak-free performance is guaranteed up to maximum working pressures as high as 8,000 psi.

### MegaSys Benefits

- Simplifies hose selection with constant pressure ratings
- Bends up to one-third SAE bend radius specifications
- Saves overall hose assembly length
- Facilitates easier routing in tight applications
- Requires fewer bent tube fittings
- Eases installation with higher flexibility
- Lowers inventory requirements
- Extends life in bending, flexing applications
- Available with abrasion-resistant XtraTuff® or MegaTuff® covers
- Reduces costs by as much as 64 percent

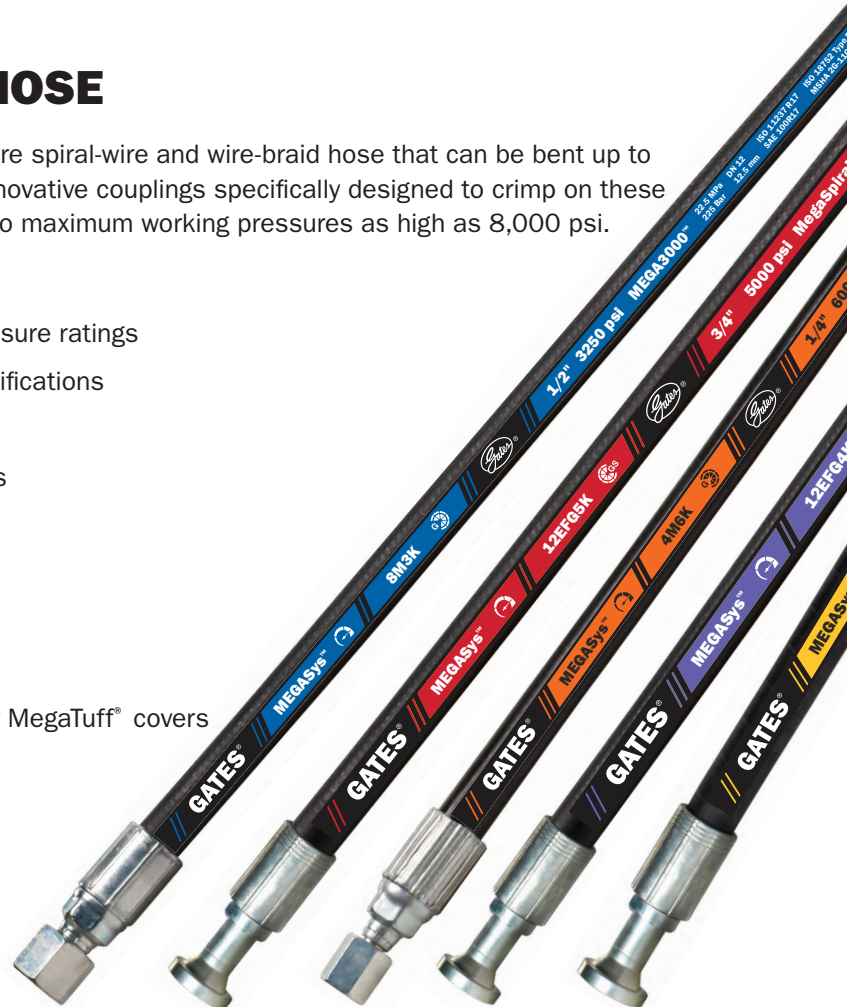





# MEGASYS® HOSE LAYLINE SYSTEM

These newly developed laylines are used exclusively on MegaSys® hose. Distinctive design and pressure color coding makes MegaSys hose easy to identify in stock or in service.

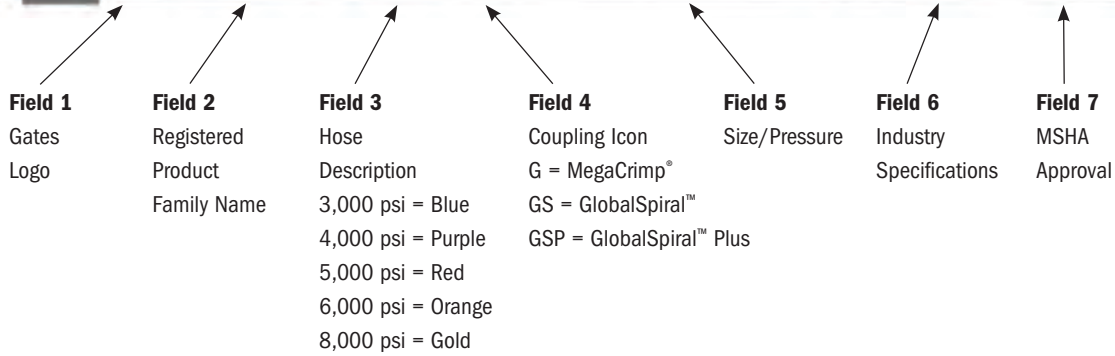

## MEGASYS HOSES BEND, BEND – AND BEND SOME MORE

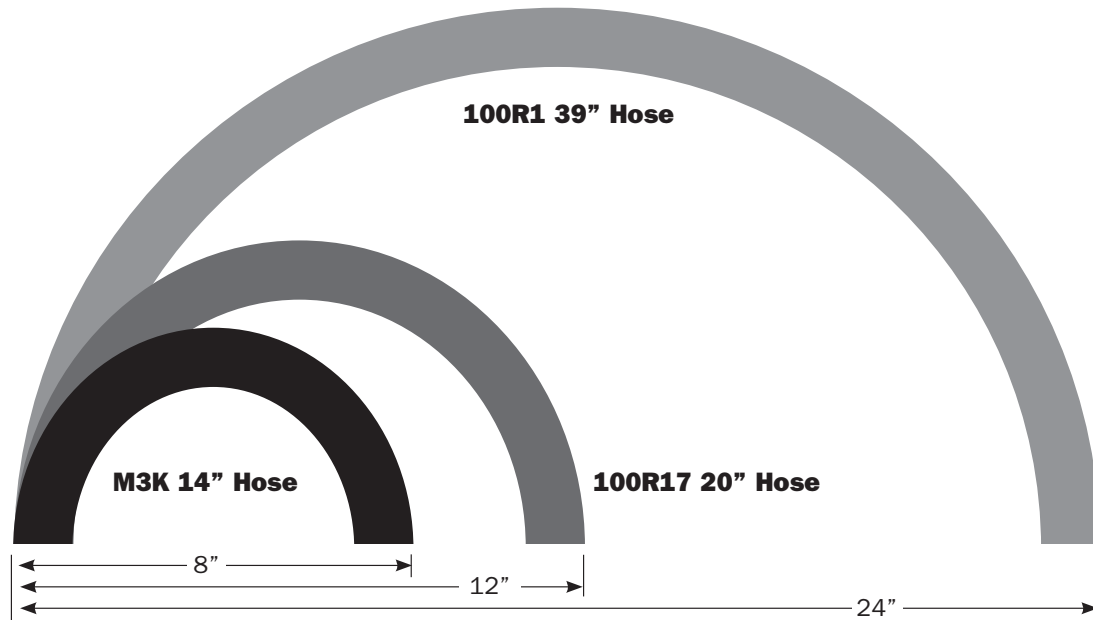

### Up to One-Third SAE Bend Radius Specification

Illustration of 16M3K hose flexibility and reduced hose length requirements



# MEGASYS® SPIRAL-WIRE CONSTANT PRESSURE HOSE

## EFG3K, EFG4K, EFG5K, EFG6K and G8K Hoses

- Each hose features a constant working pressure
- Four alternating layers (six in some larger sizes) of spiraled, high-tensile steel
- Nitrile tube for use with biodegradable hydraulic fluids (Polychloroprene for G8K)
- Tested to industry-leading 1,000,000 impulse cycles
- Temperature range -40°F to +250°F (-40°C to +121°C)
- Available with abrasion-resistant XtraTuff® or MegaTuff® cover
- “L” Versions -70°F to +212°F (-57°C to +100°C)

### MegaSys Hose Pressure Color Key

3000 psi	M3K/EFG3K
4000 psi	M4K/EFG4K
5000 psi	M5K/EFG5K
6000 psi	M6K/EFG6K
8000 psi	G8K







# MEGASYS® WIRE-BRAID CONSTANT PRESSURE HOSE

## M3K, M4K, M5K and M6K Hoses

- Each hose features a constant working pressure
- Two braids of high-tensile steel wire (one braid in M3K -3, -4, -5, -6 and -8 sizes)
- Nitrile tube for use with biodegradable hydraulic fluids
- Tested to industry-leading 600,000 cycles
- Temperature range -40°F to +212°F (-40°C to +100°C)
- Available with abrasion-resistant XtraTuff® or MegaTuff® covers
- “H” Versions -40°F to +250°F (-40°C to +121°C)
- “L” Versions -70°F to +212°F (-57°C to +100°C)

### MegaSys Hose Pressure Color Key

3000 psi	M3K/EFG3K *
4000 psi	M4K/EFG4K
5000 psi	M5K/EFG5K
6000 psi	M6K/EFG6K

\* M3K working pressure = 3250 psi



# MEGASYS® SIZE/PRESSURE MATRIX



Gates revolutionized hose selection with the introduction of MegaSys® hoses. Use the charts below for easy hose selection. Just find the required pressure and the chart will show you which hose meets that pressure in the applicable size.

## SAE Specifications (Chart colors do not correspond to MegaSys hose color key system)

I.D.	-4	-5	-6	-8	-10	-12	-16	-20	-24	-32
3000 psi	M3K*	M3K*	M3K*	M3K*	M3K*	M3K*	M3K*	EFG3K	EFG3K	EFG3K
4000 psi	M4K**	M4K**	M4K**/EFG4K	M4K**/EFG4K	M4K**/EFG4K	M4K**/EFG4K	EFG4K	EFG4K		
5000 psi	M5K	M5K	M5K	M5K/EFG5K	EFG5K	EFG5K	EFG5K	EFG5K	EFG5K	EFG5K
6000 psi	M6K		EFG6K	EFG6K	EFG6K	EFG6K	EFG6K	EFG6K	EFG6K	EFG6K
8000 psi						G8K	G8K			

■ Exceeds SAE 100R1     ■ Exceeds SAE 100R12     \*M3K Exceeds SAE 100R17  
■ Exceeds SAE 100R2     ■ Exceeds SAE 100R13     \*\*M4K Exceeds SAE 100R19  
■ Exceeds SAE 100R15     **Note:** M3K working pressure = 3250 psi

## European Norm (EN) Specifications (Chart colors do not correspond to MegaSys hose color key system)

I.D.	-4	-5	-6	-8	-10	-12	-16	-20	-24	-32
210bar/3K	M3K	M3K	M3K	M3K	M3K	M3K	M3K	EFG3K	EFG3K	EFG3K
280bar/4K	M4K	M4K	M4K/EFG4K	M4K/EFG4K	M4K/EFG4K	M4K/EFG4K	EFG4K	EFG4K		
350bar/5K	M5K	M5K	M5K	M5K/EFG5K	EFG5K	EFG5K	EFG5K	EFG5K	EFG5K	EFG5K
420bar/6K	M6K		EFG6K	EFG6K	EFG6K	EFG6K	EFG6K	EFG6K		
560bar/8K						G8K	G8K			

■ Exceeds 1SN/1SC     ■ Exceeds 4SP  
■ Exceeds 2SN/2SC     ■ Exceeds 4SH

# MegaSys® Constant Pressure Hose and ISO 18752

The progression of the Gates MegaSys® products spans over three decades, beginning in the 1980's with the innovative SAE half-bend radius MegaFlex® products M2T® and M1T (now M3K). Gates MegaSys evolved to Constant Pressure specifications and was the forerunner that drove SAE, EN and ISO to follow the Gates engineering lead.

ISO Standard 18752 released in 2006, differs from SAE J517 that reflects the design practices of users who construct hydraulic systems based on performance and pressure requirements.

ISO 18752 is the International Standard specifying requirements for nine classes, four grades and seven types of wire- or textile-reinforced hydraulic hoses and hose assemblies of nominal sizes. Each class has a single maximum working pressure for all sizes.

Hoses are classified according to their resistance to impulse into four grades: A, B, C and D. Each grade is classified by outside diameter into standard types (AS, BS and CS) and compact types (AC, BC, CC and DC).

The MegaSys products exceed the SAE and EN specifications and are aligned and exceed the performance matrix requirements of ISO 18752.

PSI	18752 ISO A	18752 ISO B	18752 ISO C	18752 ISO D
3000 PSI	M3K*	M3K	M3KH	EFG3K
4000 PSI	M4K*	M4K	M4KH	EFG4K
5000 PSI	M5K*	M5K	EFG5K	EFG5K
6000 PSI	M6K*	M6K	EFG6K	12EFG6K

\* Exceeds cycle requirements by 2.5X





# MEET MXT. THE NEXT GENERATION OF PREMIUM HYDRAULICS.

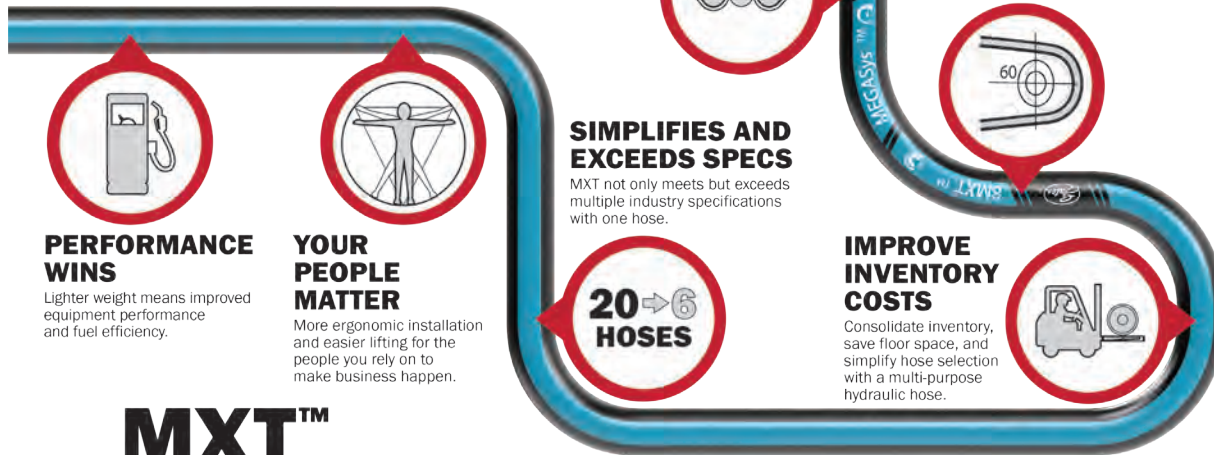
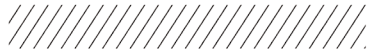

# MXT™

REDEFINING WHAT'S POSSIBLE AROUND THE WORLD

## Features + Benefits

- Patent-pending in the U.S.
- Proprietary application of materials science and processing technology
- More flexible with lower force-to-bend for faster and more ergonomic installation
- Lighter weight for easier handling
- Tested to 3 times impulse criteria (600,000 cycles)
- Consolidate inventory with a universal, multi-use hose
- Compatible with MegaCrimp® Couplings and Gates Crimpers



# INTRODUCING MULTI MASTER® GMV™ MEGAFLEX®

## ONE HOSE. FOUR USES. ULTIMATE FLEXIBILITY.



One hose engineered for four industrial applications: fuel, hydraulic return, coolant, and water, Gates Multi Master® GMV™ MegaFlex® delivers superior performance and ultimate flexibility.

We believe operating challenges are made to be overcome. That's why thousands of industrial facilities, global operations, and OE manufacturers around the world choose Gates hose and hydraulic systems to power their most demanding fluid power applications.

**MULTI-USE HOSE  
WITH SUPERIOR  
PERFORMANCE.**

### FEATURES + BENEFITS

One multi-use hose that meets SAE 100R4, J30R5, J20R5* (*except tube dimensions)	Consolidate inventory and meet global requirements
Industry-leading flexibility	Solves complex routings through tight spaces using less hose
Easy installation with 1:1 bend radius	Time saving and kink free
Light weight and ergonomic	Easy handling with lower risk of strain
ARPM Class A Tube	Provides maximum oil resistance
Sizes range from 3/4" to 6" and working pressures 150 to 350psi	Superior performance for multiple applications
MSHA approved cover	Flame resistant for critical and mining applications

## INDUSTRIAL HOSE

New to the hydraulic Catalog is a select group of Industrial Hoses. These are common hoses in all types of industry from mobile to stationary and can be crimped with hydraulic couplings to increase inventory flexibility. Please refer to your local sales representative for pricing questions.

For a full range of Industrial Hose see the Industrial Hose, Couplings and Equipment catalog (39496-000).

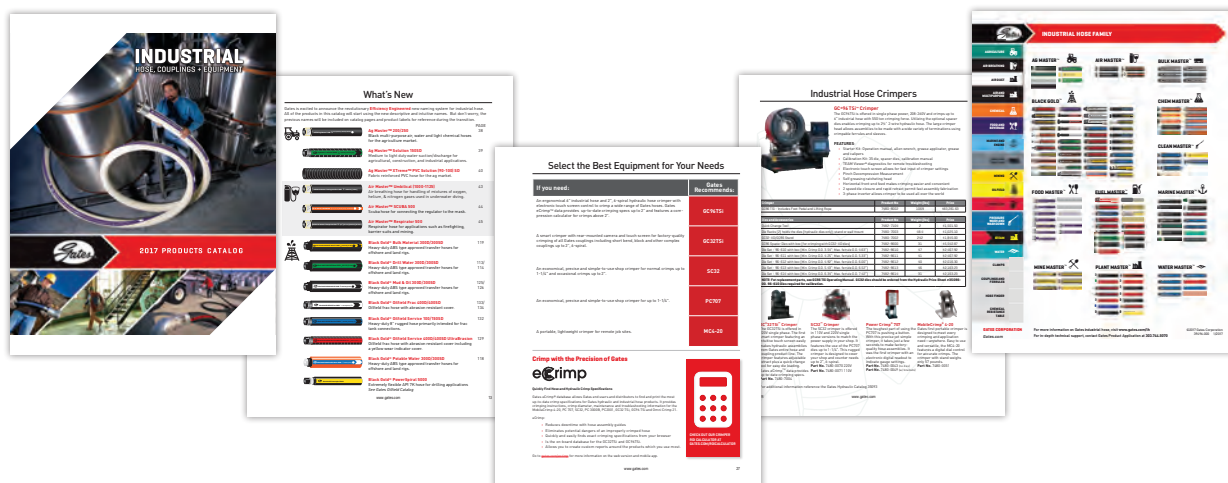



# MEGATUFF® AND XTRATUFF® COVERS

Nothing is harder on hydraulic hose covers than constant abrasion. Rubbed against metal or other hose, most standard hydraulic hoses – even ones with spring guards or nylon sleeving – can't take the punishment.

There's no industry standard for hose cover performance. Historically, Gates leads the pack in establishing engineering specs, and hose covers are no exception.

## JUDGE US BY OUR COVERS

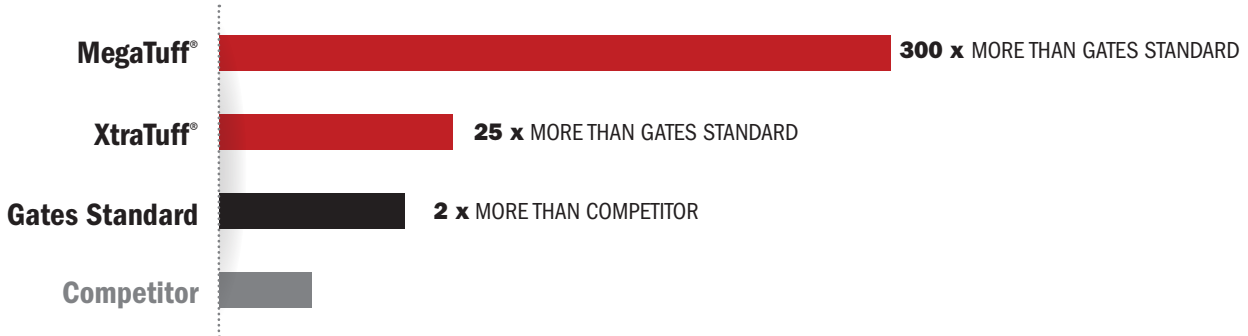

## MegaTuff®

Gates MegaTuff hoses are exceptionally resistant to abrasion. The specially bonded cover stays put and won't peel as some competitive hose covers do.

- Maintain flexibility and minimum bend radius
- Resistant to oil, ozone and UV rays
- Tested to 1,000,000 ISO6945 metal-to-hose rubbing cycles without failure



## XtraTuff®

Made of special hybrid compounds, Gates XtraTuff covers are versatile, flexible and easy to manage.

- Increase service life
- Lower maintenance
- Eliminate the need for costly hose protectors
- Lower installation friction

## Abrasion Testing

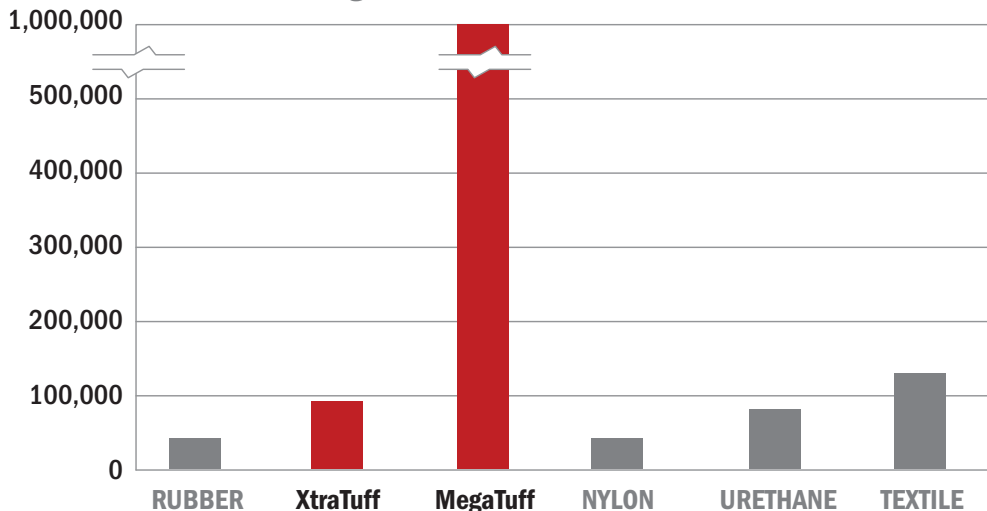



## SOLID, LEAK-FREE COUPLINGS

The majority of hydraulic hose failures occur at the couplings due to blow-offs or leaks. Gates has designed and engineered innovative, robust couplings for MegaSys hose that provide connections you can count on for superior performance – guaranteed.

### MegaCrimp® Couplings G25



#### Key Features

- Robust “bite-the-wire” crimp
- Low profile
- Full-stem insertion
- Full-length crimp
- Tested to an industry-leading 1 million impulse cycles
- Simplifies inventory management
- Environmentally-friendly TuffCoat® plating for 347% better corrosion resistance SAE Standard



#### MegaCrimp - The Versatile “No-Weep” Coupling with the Patented “C” Insert

It's what's inside the pre-assembled MegaCrimp® coupling that gives it world-class, leak-proof performance. It is designed with a patented “C” insert, attached to the ferrule, that accommodates hose of different constructions and wall thicknesses. The insert's design ensures crimping forces are evenly distributed to form a concentric seal.

The “C” insert simplifies inventory requirements since one MegaCrimp coupling size can accommodate various hose outside diameters, on both one- and two-wire braid hydraulic hose.

### GlobalSpiral™ Couplings G20



#### Key Features

- “Bite-the-wire” crimp for improved coupling retention
- Over 90 thread configurations
- Tested to an industry-leading 1,000,000 impulse cycles
- 6,000 psi working pressure for easy to manage inventory
- +250°F temperature capability for longer assembly life
- Environmentally-friendly TuffCoat® plating for 347% better corrosion resistance SAE Standard
- Qualified on wire braid hoses for maximum inventory coverage

#### GlobalSpiral Couplings No-Skive Convenience, Reduced Inventory

GlobalSpiral™ couplings are specially engineered to provide superior performance for extreme high-pressure, high-impulse spiral-wire hydraulic hose applications. They can be used with all Gates MegaSys® four- and six-spiral wire hose up to 6,000 psi.

The innovative, two-piece, no-skive design reduces assembly time, labor, fabrication errors and contamination of the fluid power system. The work area stays clean, and the odors, dust, and fire hazard normally created by skiving are eliminated. In addition, the two-piece design reduces parts inventory by 30 percent because only one stem is required for all spiral-wire hose types.



# TUFFCOAT® AND TUFFCOAT® XTREME™ PLATING

## Up to 583% Better than the 144-Hour SAE Standard

Just as hoses need a rubber cover to protect the metal reinforcement inside, hydraulic couplings need plating to prevent deterioration of the metal. When hydraulic fittings begin to rust, the base metal is being eaten away by oxidation.

Red rust can eventually damage a hydraulic system in several ways:

- Contaminate hydraulic fluids
- Compromise fitting connections and adjacent components
- Create leak paths
- Make maintenance more difficult

TuffCoat® plating sets the global standard in both corrosion resistance and environmental friendliness. Gates has removed all hexavalent chromium from its plating process. This metal, common in industrial plating, is toxic to the environment. Gates engineered TuffCoat plating to be stronger and more resistant to corrosion, without the toxicity of hexavalent chromium.

## TuffCoat: One Tough Plating for All Gates Standard Couplings

All Gates couplings are protected, at the minimum, with TuffCoat plating. In ASTM B117 salt spray tests, TuffCoat plating resisted red rust formation for 500 hours. That's nearly 347% greater than the SAE 144-hour standard.

## TuffCoat XTreme: An Extra Measure of Protection

TuffCoat XTreme offers 840 hours of red rust corrosion resistance based on ASTM B117 salt spray testing. That's 583% greater than the SAE 144-hour standard.

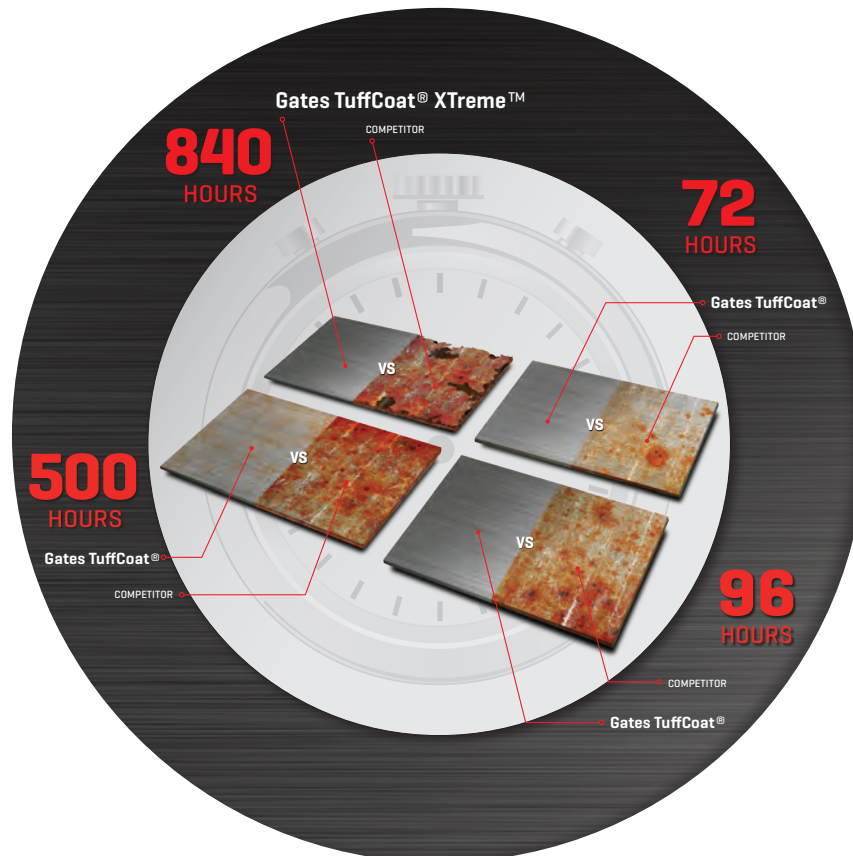



## FULL-TORQUE NUT™ TECHNOLOGY

### Over-Torque Protection

Robust swivel joint allows for maximum torque

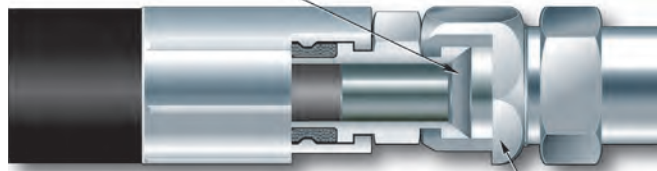

Up to 24,000 psi burst pressure (-16 size EFG6K)

Staked-nut provides less burst pressure protection

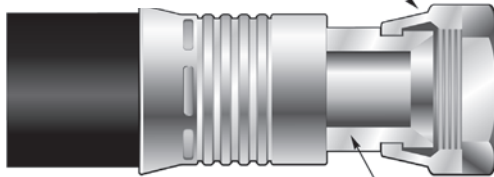

Swivel joint sensitive to over-torquing

One of the most common causes of hydraulic leaks is a cracked coupling nut or seat due to over-torque.

Gates has engineered a solution – Full-Torque Nut™ technology which is standard on all MegaCrimp® and GlobalSpiral™ couplings.

Full-Torque Nut couplings are stronger and more durable than traditional staked-nut fittings.

A large holding shoulder evenly distributes stress forces at the nut for higher resistance against cracking, even when inadvertently over-torqued. Increase equipment uptime by eliminating damaged couplings and leaks from too much torque.

## INTERNATIONAL AND NORTH AMERICAN THREAD IDENTIFICATION KITS

### Identifying Thread Styles is Easier Than Ever



#### North American Thread ID Kit

**Part Number:** 70270

**Product Number:** 7369-0016

Kit includes carrying case, 45 anodized aluminum gauges sized from 1/8–27 to 2-1/2–12 for pipe and 5/16–24 to 2-1/2–12 for UN/UNF threads, male and female. Also includes pocket thread ID kit.

#### International Thread ID Kit

**Part Number:** 70264

**Product Number:** 7369-0015

Being able to identify metric and British hydraulic couplings is essential, as sales growth of these couplings continues to outpace sales growth of couplings with more traditional North American thread types. Includes 21 metric and 10 British thread gauges, male and female. Also includes carrying case and pocket thread ID kit.

See pages C24 and C25 for additional coupling and thread identification tools.



# THERE'S A BETTER WAY TO PROTECT EQUIPMENT OPERATORS AGAINST HYDRAULIC HOSE FAILURE.

A burst or pinhole leak in a hydraulic system can cause serious problems – especially for anything or anyone located within a three-foot line-of-sight. Personal injury. Fluid burns and injection. Fires and explosions. Electrical shock. Mechanical failure.

Now, Gates has engineered the first effective, economical alternative to costly metal shielding or rerouting of hose lines. The LifeGuard® sleeving system is designed to protect operators, equipment and the environment from the hazards of catastrophic hydraulic hose failure – a level of protection previously unavailable.



LIFEGUARD SLEEVE

HOSE ONLY

LIFEGUARD SLEEVE

HOSE ONLY



The LifeGuard sleeve contained and effectively redirected fluid during 10,000 psi (68.9 MPa) burst tests while hose without sleeving exploded, releasing a large amount of fluid in the immediate area.

## How the System Works

The LifeGuard sleeve is slipped onto the hose and clamped at each end. If a hose burst or pinhole leak occurs, escaping pressures and fluids are contained by the exceptionally strong sleeving material. Fluids then exit the system via openings created by the specially designed channel clamps at each end. A noticeable pool of leaking fluid serves as positive verification that a failure has occurred so corrective action can be taken immediately to replace the hose assembly. LifeGuard sleeving correlates to a variety of industry standards, including ISO 3457 and MSHA's flame-resistance requirements.

- Provides containment of up to 10,000 psi (68.9 MPa) bursts
- Protects against 5,000 psi (34.5 MPa) pinhole leaks at +212°F (+100°C) for up to five minutes
- Handles hydraulic fluids and biodiesel fuel
- Allows fluid to safely escape down the length of the assembly
- Creates noticeable spill for hose failure detection
- Correlates to ISO 3457 and meets MSHA's flame-resistance requirements
- No other sleeve provides this level of protection
- Patented system includes Gates hose, couplings, sleeve and channel clamps





## GATES CUSTOMER SOLUTIONS CENTER

### Fluid Power Workshops

The Gates Customer Solutions Center (CSC) in Englewood, Colorado is a state-of-the-art facility dedicated to leading the industry in customer-focused product development and training in fluid power technology. Staffed by over 80 of the top engineers, scientists and technicians in the industry, the facility is headquarters for understanding and meeting customers fluid power needs.

## TRAINING WORKSHOPS FOR SALES ASSOCIATES AND YOUR CUSTOMERS

Gates Replacement market division is offering Hydraulic Training classes to help counter personnel, store managers, technicians and outside sales people increase their hydraulic knowledge to help grow business. Classes will be held at the Gates Customer Solutions Center (CSC). The sessions will combine comprehensive classroom training with individual hands-on activities and group problem solving projects.



## CLASS INFORMATION

Contact your local Gates representative for more information.

### Topics to be covered:

- Identify key components of a typical hydraulic system and explain their function
- Understand basic safety issues associated with hydraulic systems
- Duplicate existing hydraulic assemblies using the S.T.A.M.P.E.D. procedure
- Inspect systems for problematic hose routing and identify potential hose failures
- Hands-on assembly fabrication and coupling identification
- Identify accessories that prolong the life of hose and couplings
- Learn about hoses and couplings found outside of traditional hydraulic systems

Attendees will be given a tour of the Gates Customer Solution Center.

## CUSTOM PROGRAMS

Let us design a program specifically for your company's needs. We can design courses to cover equipment, safety, sales, basic knowledge and much more – we are ready to help your employees become hydraulic product experts.





## GET CONNECTED – VISIT OUR WEBSITE

With technology expanding at ever increasing rates, get the most up-to-date information from our website.

Check out what's new at [www.gates.com](http://www.gates.com)

### Features to look for:

- New product announcements
- Updated hydraulic information
- Electronic product literature
- Email updates on new products and promotions
- Downloadable catalogs: [www.gates.com/catalogs](http://www.gates.com/catalogs)
- Electronic crimp data: [www.gates.com/ecrimp](http://www.gates.com/ecrimp)
- Safety training: [www.gates.com/safehydraulics](http://www.gates.com/safehydraulics)
- Gates rep and distributor locator: [www.gates.com/contact](http://www.gates.com/contact)

### Product Application Engineers

Technical Questions on Products

303-744-5070

[fppasupport@gates.com](mailto:fppasupport@gates.com)







### Account Representatives

Fluid Power Customer Service

800-366-3128 - Industrial

800-678-4143 - Automotive

## INTERNATIONAL SYMBOLS USED IN CATALOG COLUMN HEADINGS

DESCR	Description	A	Hose/Tube Diameter
	Hose/Tube Inside Diameter (I.D.)	C	Cut-Off
	Hose/Tube Outside Diameter (O.D.)	F	Flange Head Thickness
	Thread Size	H1	Stem Hex
	Working Pressure (psi)	H2	Nut Hex
	Minimum Burst Pressure (psi)	L	Length
	Minimum Bend Radius	M	Flange Diameter
	Vacuum	T	Drop

## Crimp with the Precision of Gates

### Quickly Find Hose and Hydraulic Crimp Specifications

Gates eCrimp® database allows Gates end users and distributors to find and print the most up-to-date crimp specifications for Gates hydraulic and industrial hose products. It provides crimping instructions, crimp diameter, maintenance and troubleshooting information for all Gates crimpers.

### eCrimp:

- Reduces downtime with hose assembly guides
- Eliminates potential dangers of an improperly crimped hose
- Quickly and easily finds exact crimping specifications from your browser
- Allows you to create custom reports around the products which you use most

Go to [gates.com/ecrimp](http://gates.com/ecrimp) for more information on the web version and mobile app.



## GETTING THE BEST SERVICE LIFE FROM GATES HYDRAULIC HOSE AND ASSEMBLIES

How long will a hydraulic hose assembly last? It depends on how it's used. This catalog and other Gates literature show the recommended limits for our assemblies (and also the hose and couplings used to make assemblies). These limits include installation, maintenance, and conditions of use. These limits **MUST** be followed or the assembly can fail resulting in personal injury or property damage. If you do not have this important information, you can get it at no cost from your local Gates distributor or Gates field representative.

Hose assemblies in use should be inspected regularly for leaks, kinks, cover blisters, gouges, abrasion and other damage. Damaged or worn assemblies must be replaced immediately. You can increase assembly life if you do the following:

**Hose Assembly Installation<sup>1</sup>** – Hydraulic hose assembly installations should comply with hydraulic hose routing and plumbing standards per SAE J1273 for the proper application of hose assemblies. SAE J1273 recommended practices can be found in this catalog.

**Working Pressure** – The hydraulic system pressure should not exceed the rated working pressure of the hose. Pressure surges or peaks exceeding the rated working pressure are destructive and must be taken into account when selecting a hose.

**Minimum Burst Pressure** – Burst pressures are pressures referred to in this catalog which were intended for destructive testing purposes and for design safety factors only.

**Temperature Range<sup>2</sup>** – Do not expose hose to internal or external temperatures exceeding the recommended limits. Consult additional technical data when hydraulic fluids contain emulsions or solutions. The fluid manufacturer's recommended maximum operating temperature for any given fluid must not be exceeded, regardless of hose temperature range.

**Fluid Compatibility** – The hydraulic assembly (tube, cover, reinforcement and couplings) must be fluid compatible. The correct hose must be used because phosphate ester and petroleum-based hydraulic fluids have drastically different chemical characteristics. Many hose are compatible with one or the other, but not all fluids. For example, Gates G2XH, MegaTech<sup>®</sup> and C5D hose are capable of handling phosphate ester and petroleum-based hydraulic fluids.

**Minimum Bend Radius** – Do not bend or flex hose to a radius smaller than the minimum recommended and do not subject hose to tension or torque. This can place excessive stress on the reinforcement and severely reduce the ability of the hose to withstand pressure.

**Hose Size** – Hose size (inside diameter) must be capable of handling the required flow volume. Too small an I.D. for a given volume of flow results in excessive fluid pressure and heat generation which can result in tube damage.

**Hose Routing** – Restrain, protect or guide hose, with clamps if necessary, to minimize the risk of damage due to excessive flexing, whipping or contacting other moving parts or corrosives. Determine hose lengths and configurations that protect from abrasion, snagging or kinking and provide leak-resistant connections.

**Hose Length** – Correct hose length should include considerations for length changes under pressure, machine vibration and motion, and hose assembly routing.

**Hose Applications** – Select the proper hose for the application. Suction applications (Gates GMV or G4H) and special fluid or high temperature capabilities are among the applications requiring particular consideration and a specific hose. When additional information is required, contact your local Gates representative.

**NOTE:** Do not use Gates hydraulic hose in place of permanent piping.

### Hose Shelf Life

Storage environment, along with rubber materials can vary the shelf life limit. Shelf life is difficult to quantify as many variables affect the hose. Proper storage precautions can result in three to five years shelf life. Beyond this time there can be a significant service life decrease, depending on storage environment variables. Some variables include:

- Temperature – Hose should be stored in a cool, dry area never exceeding +100°F (+38°C). If stored below freezing, pre-warming may be required prior to handling, testing and placing into service.
- Direct sunlight, rain, heaters or being near electrical equipment
- Humidity and ozone
- Oil, solvents, corrosive materials or fumes
- Insects or rodents
- Radioactivity
- Space allowance and bends

Store hose in original container. Never stack hose too high, as its weight can crush hose at the bottom of the stack.

Gates recommends hose in extended storage be visually inspected and tested prior to use. Hose judged marginal should be replaced to avoid potential failure, property damage or bodily injury. Store hose on a first-in/first-out basis. Unusually long storage, or poor storage environment can deteriorate hose, reduce performance and may lead to premature failure.

1 SAE provides helpful video and print information that supplements this summary. Contact SAE at 1-877-606-7323 or at [www.sae.org](http://www.sae.org).

2 Actual service life at temperatures approaching the recommended limit will depend on the particular application and the fluid being used in the hose. Intermittent (up to 10 percent of operating time) refers to momentary temperature surges. Detrimental effects increase with increased exposure to elevated temperatures.

**G8K SPIRAL WIRE HOSE****SPIRAL WIRE**

RECOMMENDED FOR	Ultra high-pressure, high-impulse applications such as hydrostatic transmissions, for use in the construction, agriculture, forestry, underground or open-pit mining, or other industries on applications where extremely high-pressure capability is required. G8K hose and couplings offer industry-leading bend radius capability, which leads to ease of routing and installation, longer hose life in flexing applications, and fewer bent tube fitting requirements.
TUBE	Black, oil resistant Polychloroprene tube material allows for the high pressure, high temperature performance required in these demanding applications. See Hose Stock Characteristics.
REINFORCEMENT	Six alternating layers of high-tensile steel wire spiral construction.
COVER	Black, oil resistant, synthetic rubber (Polychloroprene), with color coded layline. See Hose Stock Characteristics.
TEMPERATURE RANGE	-40°F to +250°F (-40°C to +121°C). For water emulsions see Temperature Limits Table.
COUPLING RECOMMENDATION	G8K Couplings (G19) Section D (See Crimp Data Manual 428-7365 or eCrimp)



Meets Flame Resistance Acceptance Designation "MSHA 2G".

Part No.	Description	Product No.	Standard Pack					
71096	12G8KXCTN	4651-1639	100	3/4	1.36	8000	32000	9.5
71097	16G8KXCTN	4651-1631	100	1	1.66	8000	32000	12.0

**EFG6K SPIRAL WIRE HOSE - SAE 100R15****SPIRAL WIRE**

RECOMMENDED FOR	Extremely high-pressure, high-impulse applications such as hydrostatic transmissions. EFG6K is designed to meet or exceed all requirements of SAE 100R15 specifications and performance requirements of EN 856 4SP (-6, -8, -10 and -12), EN 856 4SH (-12, -16, and -20) and ISO 3862 Type R15 (-6, -8, -10, -12, -16, -24). Compatible with biodegradable hydraulic fluids like polyolester, polyglycol and vegetable oil as well as standard petroleum-based fluids. Available in 121' through 200' continuous lengths.
TUBE	Black, oil resistant, synthetic rubber (Nitrile). See Hose Stock Characteristics.
REINFORCEMENT	Four (six for -20, -24 and -32) alternating layers of spiraled, high-tensile steel.
COVER	Black, oil resistant, synthetic rubber (Polychloroprene), with color coded layline. Also available with unique abrasion resistant MegaTuff® cover. See Hose Stock Characteristics.
TEMPERATURE RANGE	-40°F to +250°F (-40°C to +121°C). For water emulsions see Temperature Limits Table.
COUPLING RECOMMENDATION	GlobalSpiral™ Couplings (G20) Section E GlobalSpiral™ MAX Pressure Couplings (-24 = G24), (-32 = G23) Section E Stainless Steel Spiral Couplings (-6 through -20) (G18) Section F (See Crimp Data Manual 428-7365 or eCrimp)



For Biodegradable Hydraulic Fluids. Meets Flame Resistance Acceptance Designation "MSHA 2G". Tested to Industry Leading 1,000,000 impulse cycles.





Part No.	Description	Product No.	Standard Pack					
85465	6EFG6K X25FT	4651-4032	1	3/8	.80	6000	24000	2.5
70404	6EFG6KX100REEL	4651-5028	100	3/8	.80	6000	24000	2.5
70866	6EFG6KXCTN	4651-1396	100	3/8	.80	6000	24000	2.5
70163	6EFG6KXREEL	4651-0123	300	3/8	.80	6000	24000	2.5





## EFG6K SPIRAL WIRE HOSE - SAE 100R15 - CONTINUED

## SPIRAL WIRE - CONTINUED

Part No.	Description	Product No.	Standard Pack					
85466	8EFG6K X25FT	4651-4033	1	1/2	.95	6000	24000	3.5
70405	8EFG6KX100REEL	4651-5029	100	1/2	.95	6000	24000	3.5
70865	8EFG6KXCTN	4651-1371	100	1/2	.95	6000	24000	3.5
70978	8EFG6KXLL	4651-1613	200	1/2	.95	6000	24000	3.5
70164	8EFG6KXREEL	4651-0124	240	1/2	.95	6000	24000	3.5
85467	10EFG6K X25FT	4651-4034	1	5/8	1.09	6000	24000	4.0
70815	10EFG6KXCTN	4651-1368	100	5/8	1.09	6000	24000	4.0
70735	10EFG6KXLL	4651-1397	200	5/8	1.09	6000	24000	4.0
70165	10EFG6KXREEL	4651-0125	200	5/8	1.09	6000	24000	4.0
85468	12EFG6K X25FT	4651-4035	1	3/4	1.24	6000	24000	4.7
70839	12EFG6KXCTN	4651-1288	100	3/4	1.24	6000	24000	4.7
70736	12EFG6KXLL	4651-1398	200	3/4	1.24	6000	24000	4.7
70168	12EFG6KXREEL	4651-0128	200	3/4	1.24	6000	24000	4.7
85469	16EFG6K X25FT	4651-4036	1	1	1.53	6000	24000	6.0
70836	16EFG6KXCTN	4651-1289	100	1	1.53	6000	24000	6.0
70737	16EFG6KXLL	4651-1399	200	1	1.53	6000	24000	6.0
85470	20EFG6K X25FT	4651-4037	1	1 1/4	1.97	6000	24000	8.2
70837	20EFG6KXCTN	4651-1290	50	1 1/4	1.97	6000	24000	8.2
70738	20EFG6KXLL	4651-1400	200	1 1/4	1.97	6000	24000	8.2
85426	24EFG6K X25FT	4651-1574	1	1 1/2	2.26	6000	24000	10.0
71065	24EFG6KXCTN	4651-1531	50	1 1/2	2.26	6000	24000	10.0
	24EFG6KXLL	4651-1572	200	1 1/2	2.26	6000	24000	10.0
71100	32EFG6KXCTN	4651-1759	50	2	2.80	6000	24000	25.0
71099	32EFG6KXLL	4651-1758	200	2	2.80	6000	24000	25.0



**EFG6K SPIRAL WIRE HOSE - SAE 100R15 - MEGATUFF® COVER**

**SPIRAL WIRE**

RECOMMENDED FOR	Extremely high-pressure, high-impulse applications such as hydrostatic transmissions. EFG6K is designed to meet or exceed all requirements of SAE 100R15 specifications and performance requirements of EN 856 4SP (-6, -8, -10 and -12), EN 856 4SH (-12, -16, and -20) and ISO 3862 Type R15 (-6, -8, -10, -12, -16, -24). Compatible with biodegradable hydraulic fluids like polyolester, polyglycol and vegetable oil as well as standard petroleum-based fluids. Available in 121' through 200' continuous lengths.
TUBE	Black, oil resistant, synthetic rubber (Nitrile). See Hose Stock Characteristics.
REINFORCEMENT	Four (six for -20, -24 and -32) alternating layers of spiraled, high-tensile steel.
COVER	Black, oil, abrasion and weather resistant MegaTuff® cover with color coded layline. Also available in Standard cover. See Hose Stock Characteristics.
TEMPERATURE RANGE	-40°F to +250°F (-40°C to +121°C). For water emulsions see Temperature Limits Table.
COUPLING RECOMMENDATION	GlobalSpiral™ Couplings (G20) Section E GlobalSpiral™ MAX Pressure Couplings (-24 = G24), (-32 = G23) Section E Stainless Steel Spiral Couplings (-6 through -20) (G18) Section F (See Crimp Data Manual 428-7365 or eCrimp)



For Biodegradable Hydraulic Fluids. Meets Flame Resistance Acceptance Designation "MSHA 2G". MegaTuff® hose lasts up to 300 times longer than standard hose during hose-to-hose and hose-to-metal abrasion tests per ISO 6945. Tested to Industry Leading 1,000,000 impulse cycles.

Part No.	Description	Product No.	Standard Pack	⊖	⊕	⊗	⊙	⊚
85471	6EFG6K-MTF X25FT	4651-4038	1	3/8	.80	6000	24000	2.5
70849	6EFG6K-MTFXCTN	4651-1435	100	3/8	.80	6000	24000	2.5
85472	8EFG6K-MTF X25FT	4651-4039	1	1/2	.95	6000	24000	3.5
70867	8EFG6K-MTFXCTN	4651-1609	100	1/2	.95	6000	24000	3.5
85473	10EFG6K-MTF X25FT	4651-4040	1	5/8	1.09	6000	24000	4.0
70880	10EFG6K-MTFXCTN	4651-1416	100	5/8	1.09	6000	24000	4.0
85474	12EFG6K-MTF X25FT	4651-4041	1	3/4	1.24	6000	24000	4.7
70868	12EFG6K-MTFXCTN	4651-1606	100	3/4	1.24	6000	24000	4.7
85475	16EFG6K-MTF X25FT	4651-4042	1	1	1.53	6000	24000	6.0
70869	16EFG6K-MTFXCTN	4651-1604	100	1	1.53	6000	24000	6.0
85476	20EFG6K-MTF X25FT	4651-4043	1	1 1/4	1.97	6000	24000	8.2
70870	20EFG6K-MTFXCTN	4651-1601	50	1 1/4	1.97	6000	24000	8.2
	20EFG6K-MTFXLL	4651-0013	121	1 1/4	1.97	6000	24000	8.2
70991	24EFG6K-MTFXCTN	4651-1754	50	1 1/2	2.26	6000	24000	10.0
	24EFG6K-MTFXLL	4651-1755	200	1 1/2	2.26	6000	24000	10.0
71098	32EFG6K-MTFXCTN	4651-1757	50	2	2.80	6000	24000	25.0



**EFG6KL LOW TEMP SPIRAL WIRE HOSE**

**SPIRAL WIRE**

RECOMMENDED FOR	Extremely high-pressure hydraulic applications in low-temperature environments. Compatible with biodegradable hydraulic fluids like polyolester, polyglycol and vegetable oil as well as standard petroleum-based fluid.
TUBE	Black, oil resistant, synthetic rubber (Nitrile). See Hose Stock Characteristics.
REINFORCEMENT	Four or six alternating layers of spiraled, high-tensile wire.
COVER	Black, oil resistant, synthetic rubber (Polychloroprene), with color coded layline. See Hose Stock Characteristics.
TEMPERATURE RANGE	-70°F to +212°F (-57°C to +100°C).
COUPLING RECOMMENDATION	GlobalSpiral™ Couplings (G20) Section E (See Crimp Data Manual 428-7365 or eCrimp)



Tested to Industry Leading 1,000,000 impulse cycles.

Part No.	Description	Product No.	Standard Pack						
70250	10EFG6KLXCTN	4651-0160	100	5/8	1.09	6000	24000	4.0	
70257	12EFG6KLXCTN	4651-0038	100	3/4	1.24	6000	24000	4.8	
70259	16EFG6KLXCTN	4651-0039	100	1	1.53	6000	24000	6.0	

**EFG5K SPIRAL WIRE HOSE - SAE 100R13**

**SPIRAL WIRE**

RECOMMENDED FOR	Extremely high-pressure high-impulse applications. Exceeds all requirements of ISO 18752 Grade D (except for -24) and SAE 100R13 and performance requirements of EN 856 4SH (-16 and -20), EN 856 4SP (-10, and -12), EN 856 R13 and ISO 3862 Type R13 (-12, -16, -20, -24, -32). Compatible with biodegradable hydraulic fluids like polyolester, polyglycol and vegetable oil as well as standard petroleum-based fluids. Available in 121' through 200' continuous lengths.
TUBE	Black, oil resistant, synthetic rubber (Nitrile). See Hose Stock Characteristics.
REINFORCEMENT	Four (six for -20, -24 and -32) alternating layers of spiraled, high-tensile steel.
COVER	Black, oil resistant, synthetic rubber (Polychloroprene), with color coded layline. Also available with unique abrasion resistant MegaTuff® or XtraTuff® covers. See Hose Stock Characteristics.
TEMPERATURE RANGE	-40°F to +250°F (-40°C to +121°C). For water emulsions see Temperature Limits Table.
COUPLING RECOMMENDATION	GlobalSpiral™ Couplings (G20) Section E GlobalSpiral™ MAX Pressure Couplings (-24 = G24), (-32 = G23) Section E Stainless Steel Spiral Couplings (-6 through -20) (G18) Section F (See Crimp Data Manual 428-7365 or eCrimp)







For Biodegradable Hydraulic Fluids. Meets Flame Resistance Acceptance Designation "MSHA 2G". Tested to Industry Leading 1,000,000 impulse cycles.

Part No.	Description	Product No.	Standard Pack						
85453	6EFG5K X25FT	4651-4020	1	3/8	.80	5000	20000	2.5	
70402	6EFG5KX100REEL	4651-5026	100	3/8	.80	5000	20000	2.5	
70871	6EFG5KXCTN	4651-1424	100	3/8	.80	5000	20000	2.5	
70160	6EFG5KXREEL	4651-0120	300	3/8	.80	5000	20000	2.5	
85454	8EFG5K X25FT	4651-4021	1	1/2	.95	5000	20000	3.5	
70403	8EFG5KX100REEL	4651-5027	100	1/2	.95	5000	20000	3.5	
70864	8EFG5KXCTN	4651-1372	100	1/2	.95	5000	20000	3.5	



## EFG5K SPIRAL WIRE HOSE - SAE 100R13 - CONTINUED

## SPIRAL WIRE - CONTINUED

Part No.	Description	Product No.	Standard Pack					
70977	8EFG5KXLL	4651-1612	200	1/2	.95	5000	20000	3.5
70161	8EFG5KXREEL	4651-0121	240	1/2	.95	5000	20000	3.5
85455	10EFG5K X25FT	4651-4022	1	5/8	1.09	5000	20000	4.0
70814	10EFG5KXCTN	4651-1340	100	5/8	1.09	5000	20000	4.0
70728	10EFG5KXLL	4651-1390	200	5/8	1.09	5000	20000	4.0
70162	10EFG5KXREEL	4651-0122	200	5/8	1.09	5000	20000	4.0
85456	12EFG5K X25FT	4651-4023	1	3/4	1.24	5000	20000	4.7
70838	12EFG5KXCTN	4651-1285	100	3/4	1.24	5000	20000	4.7
70729	12EFG5KXLL	4651-1391	200	3/4	1.24	5000	20000	4.7
70167	12EFG5KXREEL	4651-0127	200	3/4	1.24	5000	20000	4.7
85457	16EFG5K X25FT	4651-4024	1	1	1.53	5000	20000	6.0
70834	16EFG5KXCTN	4651-1286	100	1	1.53	5000	20000	6.0
70730	16EFG5KXLL	4651-1392	200	1	1.53	5000	20000	6.0
85458	20EFG5K X25FT	4651-4025	1	1 1/4	1.97	5000	20000	8.2
70835	20EFG5KXCTN	4651-1287	50	1 1/4	1.97	5000	20000	8.2
70734	20EFG5KXLL	4651-1393	200	1 1/4	1.97	5000	20000	8.2
85432	24EFG5K X25FT	4651-1742	1	1 1/2	2.26	5000	20000	10.0
71056	24EFG5KXCTN	4651-1455	50	1 1/2	2.26	5000	20000	10.0
	24EFG5KXLL	4651-2208	200	1 1/2	2.26	5000	20000	10.0
85436	32EFG5K X25FT	4651-1746	1	2	2.80	5000	20000	25.0
71059	32EFG5KXCTN	4651-1456	50	2	2.80	5000	20000	25.0
	32EFG5KXLL	4651-0059	200	2	2.80	5000	20000	25.0
	40EFG5K X CRATE*	4651-1817	200	2 1/2	3.35	5000	20000	30.0

\*Crimped assemblies available from Gates or factory quality assemblies can be made with the GC96TSI-3.





## EFG5K SPIRAL WIRE HOSE - SAE 100R13 - MEGATUFF® COVER

### SPIRAL WIRE

**RECOMMENDED FOR** Extremely high-pressure hydraulic applications. EFG5K exceeds all requirements of ISO 18752 Grade D (except for -24) and is designed to meet or exceed all requirements of SAE 100R13 specifications and performance requirements of EN 856 4SH (-16 and -20), EN 856 4SP (-10, and -12), EN 856 R13 and ISO 3862 Type R13 (-12, -16, -20, -24, -32). Compatible with biodegradable hydraulic fluids like polyolester, polyglycol and vegetable oil as well as standard petroleum-based fluids. Available in 121' through 200' continuous lengths.



**TUBE** Black, oil resistant, synthetic rubber (Nitrile). See Hose Stock Characteristics.

**REINFORCEMENT** Four (six for -20, -24 and -32) alternating layers of spiraled, high-tensile steel.

**COVER** Black, oil, abrasion and weather resistant MegaTuff® cover with color coded layline. Also available with unique abrasion resistant XtraTuff® or Standard covers. See Hose Stock Characteristics.

**TEMPERATURE RANGE** -40°F to +250°F (-40°C to +121°C). For water emulsions see Temperature Limits Table.

**COUPLING RECOMMENDATION** GlobalSpiral™ Couplings (G20) Section E  
GlobalSpiral™ MAX Pressure Couplings (-24 = G24), (-32 = G23)  
Section E  
Stainless Steel Spiral Couplings (G18) Section F  
(See Crimp Data Manual 428-7365 or eCrimp)

For Biodegradable Hydraulic Fluids. Meets Flame Resistance Acceptance Designation "MSHA 2G". MegaTuff® hose lasts up to 300 times longer than standard hose during hose-to-hose and hose-to-metal abrasion tests per ISO 6945. Tested to Industry Leading 1,000,000 impulse cycles.

Part No.	Description	Product No.	Standard Pack	⊖	⊕	⊖	⊕	⊖
85459	6EFG5K-MTF X25FT	4651-4026	1	3/8	.80	5000	20000	2.5
70872	6EFG5K-MTFXCTN	4651-1436	100	3/8	.80	5000	20000	2.5
85460	8EFG5K-MTF X25FT	4651-4027	1	1/2	.94	5000	20000	3.5
70873	8EFG5K-MTFXCTN	4651-1608	100	1/2	.94	5000	20000	3.5
70861	8EFG5K-MTFXLL	4651-1573	1200	1/2	.94	5000	20000	3.5
85461	10EFG5K-MTF X25FT	4651-4028	1	5/8	1.09	5000	20000	4.0
70879	10EFG5K-MTFXCTN	4651-1410	100	5/8	1.09	5000	20000	4.0
85462	12EFG5K-MTF X25FT	4651-4029	1	3/4	1.24	5000	20000	4.7
70874	12EFG5K-MTFXCTN	4651-1605	100	3/4	1.24	5000	20000	4.7
85463	16EFG5K-MTF X25FT	4651-4030	1	1	1.53	5000	20000	6.0
70875	16EFG5K-MTFXCTN	4651-1603	100	1	1.53	5000	20000	6.0
70739	16EFG5K-MTFXLL	4651-4001	200	1	1.53	5000	20000	6.0
85464	20EFG5K-MTF X25FT	4651-4031	1	1 1/4	1.97	5000	20000	8.2
70876	20EFG5K-MTFXCTN	4651-1600	50	1 1/4	1.97	5000	20000	8.2
70740	20EFG5K-MTFXLL	4651-4002	200	1 1/4	1.97	5000	20000	8.2
85433	24EFG5K-MTF X25FT	4651-1743	1	1 1/2	2.26	5000	20000	10.0
71055	24EFG5K-MTFXCTN	4651-2203	50	1 1/2	2.26	5000	20000	10.0
	24EFG5K-MTFXLL	4651-2204	200	1 1/2	2.26	5000	20000	10.0
85437	32EFG5K-MTF X25FT	4651-1747	1	2	2.80	5000	20000	25.0
71063	32EFG5K-MTFXCTN	4651-1522	50	2	2.80	5000	20000	25.0
	32EFG5K-MTFXLL	4651-2211	200	2	2.80	5000	20000	25.0

**EFG5K SPIRAL WIRE HOSE - SAE 100R13 - XTRATUFF® COVER****SPIRAL WIRE**

RECOMMENDED FOR	Extremely high-pressure high-impulse applications. Exceeds all requirements of ISO 18752 Grade D (except for -24) and exceeds all performance SAE 100R13, EN 856 R13 and ISO 3862 Type R13. Compatible with biodegradable hydraulic fluids like polyolester, polyglycol and vegetable oil as well as standard petroleum-based fluids.
TUBE	Black, oil resistant, synthetic rubber (Nitrile). See Hose Stock Characteristics.
REINFORCEMENT	Four (six for -20) alternating layers of spiraled, high-tensile steel.
COVER	Black, oil resistant, synthetic rubber (XtraTuff® Nitrile), with color coded layline. Also available with unique abrasion resistant MegaTuff® or Standard cover. See Hose Stock Characteristics.
TEMPERATURE RANGE	-40°F to +250°F (-40°C to +121°C). For water emulsions see Temperature Limits Table.
COUPLING RECOMMENDATION	GlobalSpiral™ Couplings (G20) Section E Stainless Steel Spiral Couplings (G18) Section F (See Crimp Data Manual 428-7365 or eCrimp)



For Biodegradable Hydraulic Fluids. Meets Flame Resistance Acceptance Designation "MSHA 2G". Tested to Industry Leading 1,000,000 impulse cycles.

Part No.	Description	Product No.	Standard Pack	⊖	⊕	⊖	⊕	⊖
70475	6EFG5K-XTFXLL	4651-0364	200	3/8	.80	5000	20000	2.5
70470	6EFG5K-XTFXREEL	4651-0370	300	3/8	.80	5000	20000	2.5
70481	8EFG5K-XTFXLL	4651-0365	200	1/2	.95	5000	20000	3.5
70476	8EFG5K-XTFXREEL	4651-0371	230	1/2	.95	5000	20000	3.5
70482	10EFG5K-XTFXREEL	4651-0372	220	5/8	1.09	5000	20000	4.0
70491	12EFG5K-XTFXLL	4651-0367	200	3/4	1.24	5000	20000	4.7
70484	12EFG5K-XTFXREEL	4651-0373	200	3/4	1.24	5000	20000	4.7
70510	20EFG5K-XTFXCTN	4651-0375	50	1 1/4	1.97	5000	20000	8.2
70494	20EFG5K-XTFXLL	4651-0369	200	1 1/4	1.97	5000	20000	8.2

**EFG5KL LOW TEMP SPIRAL WIRE HOSE****SPIRAL WIRE**

RECOMMENDED FOR	Extremely high-pressure hydraulic applications in low-temperature environments. Compatible with biodegradable hydraulic fluids like polyolester, polyglycol and vegetable oil as well as standard petroleum-based fluid.
TUBE	Black, oil resistant, synthetic rubber (Nitrile). See Hose Stock Characteristics.
REINFORCEMENT	Four or six alternating layers of spiraled, high-tensile wire.
COVER	Black, oil resistant, synthetic rubber (Polychloroprene), with color coded layline. See Hose Stock Characteristics.
TEMPERATURE RANGE	-70°F to +212°F (-57°C to +100°C).
COUPLING RECOMMENDATION	GlobalSpiral™ Couplings (G20) Section E GlobalSpiral™ MAX Pressure Couplings (-24 = G24), (-32 = G23) Section E (See Crimp Data Manual 428-7365 or eCrimp)



Tested to Industry Leading 1,000,000 impulse cycles.

Part No.	Description	Product No.	Standard Pack	⊖	⊕	⊖	⊕	⊖
70180	6EFG5KLXCTN	4651-0074	100	3/8	.80	5000	20000	2.5
70181	8EFG5KLXCTN	4651-0131	100	1/2	.95	5000	20000	3.5
70182	10EFG5KLXCTN	4651-0078	100	5/8	1.09	5000	20000	4.0



**EFG5KL LOW TEMP SPIRAL WIRE HOSE - CONTINUED**

**SPIRAL WIRE - CONTINUED**

Part No.	Description	Product No.	Standard Pack					
70256	12EFG5KLXCTN	4651-0020	100	3/4	1.24	5000	20000	4.8
70258	16EFG5KLXCTN	4651-0019	120	1	1.53	5000	20000	6.0
70183	20EFG5KLXCTN	4651-0058	50	1 1/4	1.97	5000	20000	8.2
70087	24EFG5KLXCTN	4651-0079	50	1 1/2	2.26	5000	20000	10.0

**ID5K SPIRAL WIRE HOSE - ISO 18752 GRADE D**

**SPIRAL WIRE**

RECOMMENDED FOR	Extremely high-pressure, high-impulse applications. Tested up to 2.3 million impulse cycles. Exceeds ISO 18752, Class 350, Grade D, Type DC. Meets SAE 100R13.
TUBE	Black, oil resistant, synthetic rubber (HNBR).
REINFORCEMENT	Four alternating layers of spiraled, high-tensile strength steel.
COVER	Black, oil, abrasion and weather resistant, synthetic rubber (Polychloroprene).
TEMPERATURE RANGE	-40°F to +250°F (-40°C to +121°C).
COUPLING RECOMMENDATION	Permanent no-skive GlobalSpiral™ (with GSID1F-4 Ferrules). (See Crimp Data Manual 428-7365 or eCrimp)



Part No.	Description	Product No.	Standard Pack					
70178	10ID5KXCTN	4651-0165	100	5/8	1.00	5000	20000	4.0
70177	10ID5KXLL	4651-0166	200	5/8	1.00	5000	20000	4.0
70112	12ID5KXCTN	4651-0167	100	3/4	1.14	5000	20000	4.7
70113	12ID5KXLL	4651-0168	200	3/4	1.14	5000	20000	4.7
70117	16ID5KXCTN	4651-0169	100	1	1.45	5000	20000	6.0
70118	16ID5KXLL	4651-0170	200	1	1.45	5000	20000	6.0

**EFG4K SPIRAL WIRE HOSE - SAE 100R12****SPIRAL WIRE**

RECOMMENDED FOR	Very high-pressure, high-impulse applications. Exceeds all requirements of ISO 18752 Grade D*, SAE 100R12, EN 856 R12 and ISO 3862 Type R12. *(Sizes 3/8", 1/2" and 5/8" exceed ISO 18752 Grade D performance but does not meet OD requirements). Compatible with biodegradable hydraulic fluids like polyolester, polyglycol and vegetable oil as well as standard petroleum-based fluids. Available in 121' through 200' continuous lengths.
TUBE	Black, oil resistant, synthetic rubber (Nitrile). See Hose Stock Characteristics.
REINFORCEMENT	Four alternating layers of spiraled, high-tensile steel wire.
COVER	Black, oil resistant, synthetic rubber (Polychloroprene), with color coded layline. Also available with unique abrasion resistant MegaTuff® or XtraTuff® covers. See Hose Stock Characteristics.
TEMPERATURE RANGE	-40°F to +250°F (-40°C to +121°C). For water emulsions see Temperature Limits Table.
COUPLING RECOMMENDATION	GlobalSpiral™ Couplings (G20) Section E GlobalSpiral™ One-Piece Couplings (MC 4-20) (-20 only) Section E Stainless Steel Spiral Couplings (G18) Section F (See Crimp Data Manual 428-7365 or eCrimp)



For Biodegradable Hydraulic Fluids. Meets Flame Resistance Acceptance Designation "MSHA 2G". Tested to Industry Leading 1,000,000 impulse cycles.

Part No.	Description	Product No.	Standard Pack	⊖	⊕	⊖	⊕	⊕
85477	6EFG4K X25FT	4651-4005	1	3/8	.80	4000	16000	2.5
85491	6EFG4K X50FT	4651-1430	1	3/8	.80	4000	16000	2.5
70400	6EFG4KX100REEL	4651-5024	100	3/8	.80	4000	16000	2.5
70811	6EFG4KXCTN	4651-1338	100	3/8	.80	4000	16000	2.5
70157	6EFG4KXREEL	4651-0117	300	3/8	.80	4000	16000	2.5
85478	8EFG4K X25FT	4651-4006	1	1/2	.94	4000	16000	3.5
85492	8EFG4K X50FT	4651-1431	1	1/2	.94	4000	16000	3.5
70401	8EFG4KX100REEL	4651-5025	100	1/2	.94	4000	16000	3.5
70863	8EFG4KXCTN	4651-1339	100	1/2	.94	4000	16000	3.5
70976	8EFG4KXLL	4651-1611	200	1/2	.94	4000	16000	3.5
70158	8EFG4KXREEL	4651-0118	240	1/2	.94	4000	16000	3.5
85479	10EFG4K X25FT	4651-4007	1	5/8	1.09	4000	16000	4.0
70813	10EFG4KXCTN	4651-1367	100	5/8	1.09	4000	16000	4.0
	10EFG4KXLL	4651-1614	200	5/8	1.09	4000	16000	4.0
70159	10EFG4KXREEL	4651-0119	200	5/8	1.09	4000	16000	4.0
85480	12EFG4K X25FT	4651-4011	1	3/4	1.21	4000	16000	4.7
85494	12EFG4K X50FT	4651-1432	1	3/4	1.21	4000	16000	4.7
70831	12EFG4KXCTN	4651-1282	100	3/4	1.21	4000	16000	4.7
70717	12EFG4KXLL	4651-1385	200	3/4	1.21	4000	16000	4.7
70166	12EFG4KXREEL	4651-0126	200	3/4	1.21	4000	16000	4.7
85481	16EFG4K X25FT	4651-4012	1	1	1.50	4000	16000	6.0
85495	16EFG4K X50FT	4651-1433	1	1	1.50	4000	16000	6.0
70807	16EFG4K X100FT	4651-1460	100	1	1.50	4000	16000	6.0
70832	16EFG4KXCTN	4651-1283	100	1	1.50	4000	16000	6.0
70718	16EFG4KXLL	4651-1386	200	1	1.50	4000	16000	6.0
85482	20EFG4K X25FT	4651-4013	1	1 1/4	1.85	4000	16000	8.2
85438	20EFG4K X50FT	4651-1520	1	1 1/4	1.85	4000	16000	8.2
70833	20EFG4KXCTN	4651-1284	50	1 1/4	1.85	4000	16000	8.2
70719	20EFG4KXLL	4651-1387	200	1 1/4	1.85	4000	16000	8.2
	48EFG4K X CRATE*	4651-1818	200	3	3.86	4000	16000	35.0

\*Crimped assemblies available from Gates or factory quality assemblies can be made with the GC96TSI-3.





## EFG4K SPIRAL WIRE HOSE - SAE 100R12 - MEGATUFF® COVER

### SPIRAL WIRE

**RECOMMENDED FOR** Very high-pressure, high-impulse extremely abrasive applications. Exceeds all requirements of ISO 18752 Grade D\*, SAE 100R12, EN 856 R12 and ISO 3862 Type R12. \*(Sizes 3/8", 1/2" and 5/8" exceed ISO 18752 Grade D performance but does not meet OD requirements). Compatible with biodegradable hydraulic fluids like polyolester, polyglycol and vegetable oil as well as standard petroleum-based fluids. Available in 121' through 200' continuous lengths.



**TUBE** Black, oil resistant, synthetic rubber (Nitrile). See Hose Stock Characteristics.

**REINFORCEMENT** Four alternating layers of spiraled, high-tensile steel wire.

**COVER** Black, oil, abrasion and weather resistant MegaTuff® cover with color coded layline. Also available with unique abrasion resistant XtraTuff® or Standard covers. See Hose Stock Characteristics.

**TEMPERATURE RANGE** -40°F to +250°F (-40°C to +121°C). For water emulsions see Temperature Limits Table.

**COUPLING RECOMMENDATION** GlobalSpiral™ Couplings (G20) Section E  
GlobalSpiral™ One-Piece Couplings (MC 4-20) (-20 only) Section E  
Stainless Steel Spiral Couplings (G18) Section F  
(See Crimp Data Manual 428-7365 or eCrimp)

For Biodegradable Hydraulic Fluids. Meets Flame Resistance Acceptance Designation "MSHA 2G". MegaTuff® hose lasts up to 300 times longer than standard hose during hose-to-hose and hose-to-metal abrasion tests per ISO 6945. Tested to Industry Leading 1,000,000 impulse cycles.

Part No.	Description	Product No.	Standard Pack	⊖	⊕	⊖	⊕	⊕
85483	6EFG4K-MTF X25FT	4651-4014	1	3/8	.80	4000	16000	2.5
70945	6EFG4K-MTFXCTN	4651-1610	100	3/8	.80	4000	16000	2.5
85484	8EFG4K-MTF X25FT	4651-4015	1	1/2	.94	4000	16000	3.5
70946	8EFG4K-MTFXCTN	4651-1607	100	1/2	.94	4000	16000	3.5
85485	10EFG4K-MTF X25FT	4651-4016	1	5/8	1.09	4000	16000	4.0
70947	10EFG4K-MTFXCTN	4651-1404	100	5/8	1.09	4000	16000	4.0
85486	12EFG4K-MTF X25FT	4651-4017	1	3/4	1.21	4000	16000	4.7
70877	12EFG4K-MTFXCTN	4651-1405	100	3/4	1.21	4000	16000	4.7
70726	12EFG4K-MTFXLL	4651-1388	200	3/4	1.21	4000	16000	4.7
85487	16EFG4K-MTF X25FT	4651-4018	1	1	1.50	4000	16000	6.0
70948	16EFG4K-MTFXCTN	4651-1406	100	1	1.50	4000	16000	6.0
70727	16EFG4K-MTFXLL	4651-1389	200	1	1.50	4000	16000	6.0
85488	20EFG4K-MTF X25FT	4651-4019	1	1 1/4	1.85	4000	16000	8.2
70949	20EFG4K-MTFXCTN	4651-1602	50	1 1/4	1.85	4000	16000	8.2
	20EFG4K-MTFXLL	4651-1638	200	1 1/4	1.85	4000	16000	8.2



**EFG4K SPIRAL WIRE HOSE - SAE 100R12 - XTRATUFF® COVER**

**SPIRAL WIRE**

RECOMMENDED FOR	Very high-pressure, high-impulse abrasive applications. Exceeds all requirements of ISO 18752 Grade D*, SAE 100R12, EN 856 R12 and ISO 3862 Type R12. *(Sizes 3/8", 1/2" and 5/8" exceed ISO 18752 Grade D performance but does not meet OD requirements). Compatible with biodegradable hydraulic fluids like polyolester, polyglycol and vegetable oil as well as standard petroleum based fluids. Available in 121' through 200' continuous lengths.
TUBE	Black, oil resistant, synthetic rubber (Nitrile). See Hose Stock Characteristics.
REINFORCEMENT	Four alternating layers of spiraled, high-tensile steel wire.
COVER	Black, oil and abrasion resistant, synthetic rubber (XtraTuff® Nitrile), with color coded layline. Also available with unique abrasion resistant MegaTuff® or Standard covers. See Hose Stock Characteristics.
TEMPERATURE RANGE	-40°F to +250°F (-40°C to +121°C). For water emulsions see Temperature Limits Table.
COUPLING RECOMMENDATION	GlobalSpiral™ Couplings (G20) Section E GlobalSpiral™ One-Piece Couplings (MC 4-20) (-20 only) Section E Stainless Steel Spiral Couplings (G18) Section F (See Crimp Data Manual 428-7365 or eCrimp)



Tested to Industry Leading 1,000,000 impulse cycles.

Part No.	Description	Product No.	Standard Pack	⊖	⊕	⊙	⊙	⊙
70410	6EFG4K-XTFXLL	4651-0251	200	3/8	.80	4000	16000	2.5
70411	6EFG4K-XTFXREEL	4651-0263	300	3/8	.80	4000	16000	2.5
70412	8EFG4K-XTFXLL	4651-0253	200	1/2	.94	4000	16000	3.5
70413	8EFG4K-XTFXREEL	4651-0264	230	1/2	.94	4000	16000	3.5
70511	10EFG4K-XTFXLL	4651-0255	200	5/8	1.09	4000	16000	4.0
70512	12EFG4K-XTFXCTN	4651-0256	100	5/8	1.09	4000	16000	4.0
70414	12EFG4K-XTFXLL	4651-0257	200	3/4	1.21	4000	16000	4.7
70415	12EFG4K-XTFXREEL	4651-0266	200	3/4	1.21	4000	16000	4.7
70416	16EFG4K-XTFXCTN	4651-0258	100	1	1.50	4000	16000	6.0
70417	16EFG4K-XTFXLL	4651-0259	200	1	1.50	4000	16000	6.0
70418	20EFG4K-XTFXCTN	4651-0260	50	1 1/4	1.85	4000	16000	8.2
70419	20EFG4K-XTFXLL	4651-0261	200	1 1/4	1.85	4000	16000	8.2



**EFG4KL LOW TEMP SPIRAL WIRE HOSE**

**SPIRAL WIRE**

RECOMMENDED FOR	Very high-pressure hydraulic applications in low-temperature environments. Compatible with biodegradable hydraulic fluids like polyolester, polyglycol and vegetable oil as well as standard petroleum-based fluid.
TUBE	Black, oil resistant, synthetic rubber (Nitrile). See Hose Stock Characteristics.
REINFORCEMENT	Four alternating layers of spiraled, high-tensile wire.
COVER	Black, oil resistant, synthetic rubber (Polychloroprene), with color coded layline. See Hose Stock Characteristics.
TEMPERATURE RANGE	-70°F to +212°F (-57°C to +100°C).
COUPLING RECOMMENDATION	GlobalSpiral™ Couplings (G20) Section E GlobalSpiral™ One-Piece Couplings (MC 4-20) (-20 only) Section E (See Crimp Data Manual 428-7365 or eCrimp)



Tested to Industry Leading 1,000,000 impulse cycles.

Part No.	Description	Product No.	Standard Pack	⊖	⊕	⊗	⊙	⊚
77001	12EFG4KLXCTN	4651-0023	100	3/4	1.24	4000	16000	4.8
77002	16EFG4KLXCTN	4651-0024	100	1	1.53	4000	16000	6.0
70086	20EFG4KLXCTN	4651-0075	50	1 1/4	1.85	4000	16000	8.3

**EFG3K SPIRAL WIRE HOSE - SAE 100R12**

**SPIRAL WIRE**

RECOMMENDED FOR	Very high-pressure, high-impulse applications. Exceeds all requirements for ISO 18752 Grade D, SAE 100R12, EN 856 R12, and performance requirements of EN 856 4SP, and ISO 3862 Type R12. Compatible with biodegradable hydraulic fluids like polyolester, polyglycol and vegetable oil as well as standard petroleum-based fluids. Available in 121' through 200' continuous lengths.
TUBE	Black, oil resistant, synthetic rubber (Nitrile). See Hose Stock Characteristics.
REINFORCEMENT	Four alternating layers of spiraled, high-tensile steel wire.
COVER	Black, oil resistant, synthetic rubber (Polychloroprene), with color coded layline. Also available with unique abrasion resistant MegaTuff® cover. See Hose Stock Characteristics.
TEMPERATURE RANGE	-40°F to +250°F (-40°C to +121°C). For water emulsions see Temperature Limits Table.
COUPLING RECOMMENDATION	GlobalSpiral™ Couplings (-20) (G20) Section E GlobalSpiral™ One-Piece Couplings (MC 4-20) (-20 only) Section E GlobalSpiral™ Plus Couplings (-24 and -32) (G22) Section E Stainless Steel Braid Couplings (-24 and -32) (G17) Section H Stainless Steel Spiral Couplings (-20) (G18) Section F (See Crimp Data Manual 428-7365 or eCrimp)



For Biodegradable Hydraulic Fluids. Meets Flame Resistance Acceptance Designation "MSHA 2G". Tested to Industry Leading 1,000,000 impulse cycles.

Part No.	Description	Product No.	Standard Pack	⊖	⊕	⊗	⊙	⊚
85489	20EFG3K X25FT	4651-4003	1	1 1/4	1.85	3000	12000	8.2
85497	20EFG3K X50FT	4651-1434	1	1 1/4	1.85	3000	12000	8.2
70539	20EFG3KXCTN	4651-1381	100	1 1/4	1.85	3000	12000	8.2
70707	20EFG3KXLL	4651-1384	200	1 1/4	1.85	3000	12000	8.2
85430	24EFG3K X25FT	4651-1740	1	1 1/2	2.11	3000	12000	10.0
71054	24EFG3KXCTN	4651-1451	50	1 1/2	2.11	3000	12000	10.0
	24EFG3KXLL	4651-2207	200	1 1/2	2.11	3000	12000	10.0
85434	32EFG3K X25FT	4651-1744	1	2	2.63	3000	12000	12.5



**EFG3K SPIRAL WIRE HOSE - SAE 100R12 - CONTINUED**

**SPIRAL WIRE - CONTINUED**

Part No.	Description	Product No.	Standard Pack					
	32EFG3KX50INC	4651-2209	200	2	2.63	3000	12000	12.5
71058	32EFG3KXCTN	4651-1452	50	2	2.63	3000	12000	12.5
70265	32EFG3KXLL	4651-2210	200	2	2.63	3000	12000	12.5

**EFG3K SPIRAL WIRE HOSE - SAE 100R12 - MEGATUFF® COVER**

**SPIRAL WIRE**

**RECOMMENDED FOR** Very high-pressure, high-impulse applications. Exceeds all requirements for ISO 18752 Grade D, exceeds all performance requirements for SAE 100R12, EN 856 R12, performance requirements of EN 856 4SP and ISO 3862 Type R12. Compatible with biodegradable hydraulic fluids like polyolester, polyglycol and vegetable oil as well as standard petroleum-based fluids. Available in 121' through 200' continuous lengths.



<b>TUBE</b>	Black, oil resistant, synthetic rubber (Nitrile). See Hose Stock Characteristics.
<b>REINFORCEMENT</b>	Four alternating layers of spiraled, high-tensile steel wire.
<b>COVER</b>	Black, oil, abrasion and weather resistant MegaTuff® cover with color coded layline. Also available in Standard cover. See Hose Stock Characteristics.
<b>TEMPERATURE RANGE</b>	-40°F to +250°F (-40°C to +121°C). For water emulsions see Temperature Limits Table.
<b>COUPLING RECOMMENDATION</b>	GlobalSpiral™ Couplings (-20) (G20) Section E GlobalSpiral™ One-Piece Couplings (MC 4-20) (-20 only) Section E GlobalSpiral™ Plus Couplings (-24 and -32) (G22) Section E (See Crimp Data Manual 428-7365 or eCrimp)

For Biodegradable Hydraulic Fluids. Meets Flame Resistance Acceptance Designation "MSHA 2G". MegaTuff® hose lasts up to 300 times longer than standard hose during hose-to-hose and hose-to-metal abrasion tests per ISO 6945. Tested to Industry Leading 1,000,000 impulse cycles.

Part No.	Description	Product No.	Standard Pack					
85490	20EFG3K-MTF X25FT	4651-4004	1	1 1/4	1.85	3000	12000	8.2
70950	20EFG3K-MTFXCTN	4651-1425	100	1 1/4	1.85	3000	12000	8.2
70951	20EFG3K-MTFXLL	4651-1427	200	1 1/4	1.85	3000	12000	8.2
85431	24EFG3K-MTF X25FT	4651-1741	1	1 1/2	2.11	3000	12000	10.0
71053	24EFG3K-MTFXCTN	4651-2201	50	1 1/2	2.11	3000	12000	10.0
	24EFG3K-MTFXLL	4651-2202	200	1 1/2	2.11	3000	12000	10.0
85435	32EFG3K-MTF X25FT	4651-1745	1	2	2.63	3000	12000	25.0
71057	32EFG3K-MTFXCTN	4651-2205	50	2	2.63	3000	12000	25.0
	32EFG3K-MTFXLL	4651-2206	200	2	2.63	3000	12000	25.0





## GLOBAL M6K MEGA6000™ HOSE

### WIRE BRAID

RECOMMENDED FOR	High-pressure hydraulic applications. Provides tighter than standard minimum bend radius and greater flexibility for easier plumbing.
TUBE	Black, oil resistant, synthetic rubber (Nitrile). See Hose Stock Characteristics.
REINFORCEMENT	Two braids of high-tensile steel wire.
COVER	Black, oil, abrasion and weather resistant, synthetic rubber (Nitrile and PVC), with color coded layline. See Hose Stock Characteristics.
TEMPERATURE RANGE	-40°F to +212°F (-40°C to +100°C). For water emulsions see Temperature Limits Table.
COUPLING RECOMMENDATION	MegaCrimp® Couplings (G25) Section G Stainless Steel Braid Couplings (G17) Section H (See Crimp Data Manual 428-7365 or eCrimp)



Meets Flame Resistance Acceptance Designation "MSHA 2G". Tested to Industry Leading 600,000 impulse cycles.

Part No.	Description	Product No.	Standard Pack					
70599	4M6KXREEL	4657-2697	440	1/4	.58	6000	24000	2.0

## GLOBAL M5K MEGA5000™ HOSE

### WIRE BRAID

RECOMMENDED FOR	High-pressure hydraulic applications. Exceeds ISO 18752 Grade B. Provides tighter than standard minimum bend radius and greater flexibility for easier plumbing.
TUBE	Black, oil resistant, synthetic rubber (Nitrile). See Hose Stock Characteristics.
REINFORCEMENT	Two braids of high-tensile steel wire.
COVER	Black, oil, abrasion and weather resistant, synthetic rubber (Nitrile and PVC -4, -5, -6), (Polychloroprene -8) with color coded layline. Also available with unique abrasion resistant MegaTuff® or XtraTuff® covers. See Hose Stock Characteristics.
TEMPERATURE RANGE	-40°F to +212°F (-40°C to +100°C). For water emulsions see Temperature Limits Table.
COUPLING RECOMMENDATION	GlobalSpiral™ Couplings (-6 and -8) (G20) Section E MegaCrimp® Couplings (G25) Section G Stainless Steel Braid Couplings (G17) Section H (See Crimp Data Manual 428-7365 or eCrimp)



Meets Flame Resistance Acceptance Designation "MSHA 2G". Tested to Industry Leading 600,000 impulse cycles.

Part No.	Description	Product No.	Standard Pack					
85607	4M5K X50FT	4657-4122	1	1/4	.55	5000	20000	2.0
70596	4M5KXREEL	4657-1100	440	1/4	.55	5000	20000	2.0
70449	5M5KXREEL	4657-8006	350	5/16	.61	5000	20000	2.2
85606	6M5K X50FT	4657-4121	1	3/8	.70	5000	20000	2.5
70597	6M5KXREEL	4657-2695	330	3/8	.70	5000	20000	2.5
85608	8M5K X50FT	4657-4123	1	1/2	.86	5000	20000	3.5
70598	8M5KXREEL	4657-2650	220	1/2	.86	5000	20000	3.5

**GLOBAL M5K MEGA5000™ HOSE - MEGATUFF® COVER****WIRE BRAID**

RECOMMENDED FOR	High-pressure hydraulic applications. Exceeds ISO 18752 Grade B. Provides tighter than standard minimum bend radius and greater flexibility for easier plumbing.
TUBE	Black, oil resistant, synthetic rubber (Nitrile). See Hose Stock Characteristics.
REINFORCEMENT	Two braids of high-tensile steel wire.
COVER	Black, oil, abrasion and weather resistant MegaTuff® cover with color coded layline. Also available with unique abrasion resistant XtraTuff® or Standard covers. See Hose Stock Characteristics.
TEMPERATURE RANGE	-40°F to +212°F (-40°C to +100°C). For water emulsions see Temperature Limits Table.
COUPLING RECOMMENDATION	GlobalSpiral™ Couplings (-6 and -8) (G20) Section E MegaCrimp® Couplings (G25) Section G Stainless Steel Braid Couplings (G17) Section H (See Crimp Data Manual 428-7365 or eCrimp)



Meets Flame Resistance Acceptance Designation "MSHA 2G". Tested to Industry Leading 600,000 impulse cycles.

Part No.	Description	Product No.	Standard Pack					
70386	4M5K-MTFXREEL	4657-8011	440	1/4	.55	5000	20000	2.0
70343	5M5K-MTFXREEL	4657-8012	350	5/16	.61	5000	20000	2.2
70340	6M5K-MTFXREEL	4657-8013	330	3/8	.70	5000	20000	2.5
70329	8M5K-MTFXREEL	4657-8014	220	1/2	.86	5000	20000	3.5

**GLOBAL M5K MEGA5000™ HOSE - XTRATUFF® COVER****WIRE BRAID**

RECOMMENDED FOR	High-pressure hydraulic applications. Exceeds ISO 18752 Grade B. Provides tighter than standard minimum bend radius and greater flexibility for easier plumbing.
TUBE	Black, oil resistant, synthetic rubber (Nitrile). See Hose Stock Characteristics.
REINFORCEMENT	Two braids of high-tensile steel wire.
COVER	Black, oil, abrasion and weather resistant, synthetic rubber (XtraTuff® Nitrile), with color coded layline. Also available with unique abrasion resistant MegaTuff® or Standard covers. See Hose Stock Characteristics.
TEMPERATURE RANGE	-40°F to +212°F (-40°C to +100°C). For water emulsions see Temperature Limits Table.
COUPLING RECOMMENDATION	GlobalSpiral™ Couplings (-6 and -8) (G20) Section E MegaCrimp® Couplings (G25) Section G Stainless Steel Braid Couplings (G17) Section H (See Crimp Data Manual 428-7365 or eCrimp)



Meets Flame Resistance Acceptance Designation "MSHA 2G". Tested to Industry Leading 600,000 impulse cycles.

Part No.	Description	Product No.	Standard Pack					
70423	4M5K-XTFXREEL	4657-8007	440	1/4	.55	5000	20000	2.0
70428	5M5K-XTFXREEL	4657-8008	375	5/16	.61	5000	20000	2.2
70430	6M5K-XTFXREEL	4657-8009	330	3/8	.70	5000	20000	2.5
70399	8M5K-XTFXREEL	4657-8010	220	1/2	.86	5000	20000	3.5



## GLOBAL M4K MEGA4000™ HOSE - SAE 100R19

### WIRE BRAID

**RECOMMENDED FOR** High-pressure hydraulic applications. Exceeds ISO 18752 Grade B, SAE 100R19 and ISO 11237 R19. Allows for tighter minimum bend radius, increased working pressure and improved impulse cycles than industry standards. Provides greater performance, flexibility, easier routing and plumbing of mobile and stationary hydraulic platforms.

**TUBE** Black, oil resistant, synthetic rubber (Nitrile). See Hose Stock Characteristics.

**REINFORCEMENT** Two braids of high-tensile steel wire.

**COVER** Black, oil, abrasion and weather resistant, synthetic rubber (Nitrile and PVC), with color coded layline. Also available with unique abrasion resistant MegaTuff® or XtraTuff® covers. See Hose Stock Characteristics.

**TEMPERATURE RANGE** -40°F to +212°F (-40°C to +100°C). For water emulsions see Temperature Limits Table.

**COUPLING RECOMMENDATION** GlobalSpiral™ Couplings (-6 through -16) (G20) Section E  
MegaCrimp® Couplings (-4 through -12) (G25) Section G  
Stainless Steel Braid Couplings (-4 through -8) (G17) Section H  
Stainless Steel Spiral Couplings (-12 and -16) (G18) Section F  
(See Crimp Data Manual 428-7365 or eCrimp)



Meets Flame Resistance Acceptance Designation "MSHA 2G" and ISO 11237 R19. Tested to Industry Leading 600,000 impulse cycles.

Part No.	Description	Product No.	Standard Pack	⊖	⊕	⊖	⊕	⊖
85616	4M4K X50FT	4657-1238	1	1/4	.55	4000	16000	1.5
	4M4KXBALE	4657-5779	5600	1/4	.55	4000	16000	1.5
70829	4M4KXREEL	4657-1467	440	1/4	.55	4000	16000	1.5
70457	5M4KXREEL	4657-8015	350	5/16	.61	4000	16000	1.8
85617	6M4K X50FT	4657-4867	1	3/8	.70	4000	16000	2.0
	6M4KXBALE	4657-5775	3800	3/8	.70	4000	16000	2.0
70821	6M4KXREEL	4657-1458	330	3/8	.70	4000	16000	2.0
85618	8M4K X50FT	4657-4868	1	1/2	.82	4000	16000	2.8
	8M4KXBALE	4657-5776	2200	1/2	.82	4000	16000	2.8
70822	8M4KXREEL	4657-1459	220	1/2	.82	4000	16000	2.8
85619	10M4K X50FT	4657-4869	1	5/8	.99	4000	16000	3.0
	10M4KXBALE	4657-5777	1750	5/8	.99	4000	16000	3.0
70823	10M4KXREEL	4657-1460	220	5/8	.99	4000	16000	3.0
85620	12M4K X50FT	4657-4870	1	3/4	1.17	4000	16000	3.8
	12M4KXBALE	4657-5778	1250	3/4	1.17	4000	16000	3.8
70824	12M4KXREEL	4657-1461	220	3/4	1.17	4000	16000	3.8
71064	16M4KXREEL	4657-4051	165	1	1.52	4000	16000	4.5



**GLOBAL M4K MEGA4000™ HOSE - SAE 100R19 - MEGATUFF® COVER**

**WIRE BRAID**

RECOMMENDED FOR	High-pressure hydraulic applications. Exceeds ISO 18752 Grade B, SAE 100R19 and ISO 11237 R19. Allows for tighter minimum bend radius, increased working pressure and improved impulse cycles than industry standards. Provides greater performance, flexibility, easier routing and plumbing of mobile and stationary hydraulic platforms.
TUBE	Black, oil resistant, synthetic rubber (Nitrile). See Hose Stock Characteristics.
REINFORCEMENT	Two braids of high-tensile steel wire.
COVER	Black, oil, abrasion and weather resistant MegaTuff® cover with color coded layline. Also available with unique abrasion resistant XtraTuff® or Standard covers. See Hose Stock Characteristics.
TEMPERATURE RANGE	-40°F to +212°F (-40°C to +100°C). For water emulsions see Temperature Limits Table.
COUPLING RECOMMENDATION	GlobalSpiral™ Couplings (-6 through -16) (G20) Section E MegaCrimp® Couplings (-4 through -12) (G25) Section G Stainless Steel Braid Couplings (-4 through -8) (G17) Section H Stainless Steel Spiral Couplings (-12 and -16) (G18) Section F (See Crimp Data Manual 428-7365 or eCrimp)



Meets Flame Resistance Acceptance Designation "MSHA 2G" and ISO 11237 R19. MegaTuff® hose lasts up to 300 times longer than standard hose during hose-to-hose and hose-to-metal abrasion tests per ISO 6945. Tested to Industry Leading 600,000 impulse cycles.

Part No.	Description	Product No.	Standard Pack	⊖	⊕	⊙	⊙	⊙
85519	4M4K-MTF X50FT	4657-1239	1	1/4	.55	4000	16000	1.5
70830	4M4K-MTFXREEL	4657-1477	350	1/4	.55	4000	16000	1.5
70326	5M4K-MTFXREEL	4657-8017	350	5/16	.61	4000	16000	1.8
85520	6M4K-MTF X50FT	4657-4020	1	3/8	.70	4000	16000	2.0
70825	6M4K-MTFXREEL	4657-1479	330	3/8	.70	4000	16000	2.0
85521	8M4K-MTF X50FT	4657-4021	1	1/2	.82	4000	16000	2.8
	8M4K-MTFXBALE	4657-5016	3200	1/2	.82	4000	16000	2.8
70826	8M4K-MTFXREEL	4657-1480	220	1/2	.82	4000	16000	2.8
85522	10M4K-MTF X50FT	4657-4022	1	5/8	.99	4000	16000	3.0
70827	10M4K-MTFXREEL	4657-1481	220	5/8	.99	4000	16000	3.0
85524	12M4K-MTF X50FT	4657-4024	1	3/4	1.17	4000	16000	3.8
70828	12M4K-MTFXREEL	4657-1482	190	3/4	1.17	4000	16000	3.8
71103	16M4K-MTFXREEL	4657-4053	165	1	1.52	4000	16000	4.5



**GLOBAL M4K MEGA4000™ HOSE - SAE 100R19 - XTRATUFF® COVER**

**WIRE BRAID**

**RECOMMENDED FOR** High-pressure hydraulic applications. Exceeds ISO 18752 Grade B, SAE 100R19 and ISO 11237 R19. Allows for tighter minimum bend radius, increased working pressure and improved impulse cycles than industry standards. Provides greater performance, flexibility, easier routing and plumbing of mobile and stationary hydraulic platforms.

**TUBE** Black, oil resistant, synthetic rubber (Nitrile). See Hose Stock Characteristics.

**REINFORCEMENT** Two braids of high-tensile steel wire.

**COVER** Black, oil, abrasion and weather resistant, synthetic rubber (XtraTuff® Nitrile), with color coded layline. Also available with unique abrasion resistant MegaTuff® or Standard covers. See Hose Stock Characteristics.

**TEMPERATURE RANGE** -40°F to +212°F (-40°C to +100°C). For water emulsions see Temperature Limits Table.

**COUPLING RECOMMENDATION** GlobalSpiral™ Couplings (-6 through -16) (G20) Section E  
 MegaCrimp® Couplings (-4 through -12) (G25) Section G  
 Stainless Steel Braid Couplings (-4 through -8) (G17) Section H  
 Stainless Steel Spiral Couplings (-12 and -16) (G18) Section F  
 (See Crimp Data Manual 428-7365 or eCrimp)



Meets Flame Resistance Acceptance Designation "MSHA 2G" and ISO 11237 R19. Tested to Industry Leading 600,000 impulse cycles. XtraTuff® hose lasts up to 25 times longer than standard hose during hose-to-hose and hose-to-metal abrasion tests per ISO 6945.

Part No.	Description	Product No.	Standard Pack	⊖	⊕	⊙	⊙	⊙
85541	4M4K-XTF X50FT	4657-2616	1	1/4	.55	4000	16000	1.5
70693	4M4K-XTFXREEL	4657-2281	440	1/4	.55	4000	16000	1.5
70459	5M4K-XTFXREEL	4657-8016	350	5/16	.61	4000	16000	1.8
85542	6M4K-XTF X50FT	4657-2615	1	3/8	.70	4000	16000	2.0
70694	6M4K-XTFXREEL	4657-2283	330	3/8	.70	4000	16000	2.0
85543	8M4K-XTF X50FT	4657-2614	1	1/2	.82	4000	16000	2.8
70695	8M4K-XTFXREEL	4657-2284	220	1/2	.82	4000	16000	2.8
70696	10M4K-XTFXREEL	4657-2285	220	5/8	.99	4000	16000	3.0
70697	12M4K-XTFXREEL	4657-2286	220	3/4	1.17	4000	16000	3.8
71104	16M4K-XTFXREEL	4657-4052	165	1	1.52	4000	16000	4.5



**GLOBAL M4KH MEGA4000™ HOSE - HIGH-TEMP - SAE 100R19****WIRE BRAID**

RECOMMENDED FOR	High-pressure hydraulic applications at elevated temperatures. Exceeds ISO 18752 Grade C, SAE 100R19 and ISO 11237 R19. Allows for tighter minimum bend radius, increased working pressure and improved impulse cycles than industry standards. Provides greater performance, flexibility, easier routing and plumbing of mobile and stationary hydraulic platforms.
TUBE	Black, oil resistant, synthetic rubber (Nitrile). See Hose Stock Characteristics.
REINFORCEMENT	Two braids of high-tensile steel wire.
COVER	Black, oil, abrasion and weather resistant, synthetic rubber (Polychloroprene), with color coded layline. Also available with unique abrasion resistant MegaTuff® cover. See Hose Stock Characteristics.
TEMPERATURE RANGE	-40°F to +250°F (-40°C to +121°C). For water emulsions see Temperature Limits Table.
COUPLING RECOMMENDATION	GlobalSpiral™ Couplings (-6 through -12) (G20) Section E MegaCrimp® Couplings (G25) Section G (See Crimp Data Manual 428-7365 or eCrimp)



Meets Flame Resistance Acceptance Designation "MSHA 2G" and ISO 11237 R19. Tested to Industry Leading 600,000 impulse cycles.

Part No.	Description	Product No.	Standard Pack					
85540	4M4KH X50FT	4657-4098	1	1/4	.55	4000	16000	2.0
70901	4M4KH XREEL	4657-2381	440	1/4	.55	4000	16000	2.0
85546	6M4KH X50FT	4657-4099	1	3/8	.70	4000	16000	2.5
70902	6M4KH XREEL	4657-2383	330	3/8	.70	4000	16000	2.5
85547	8M4KH X50FT	4657-4100	1	1/2	.82	4000	16000	3.5
70903	8M4KH XREEL	4657-2384	220	1/2	.82	4000	16000	3.5
85548	10M4KH X50FT	4657-4101	1	5/8	.99	4000	16000	4.0
70904	10M4KH XREEL	4657-2385	220	5/8	.99	4000	16000	4.0
85549	12M4KH X50FT	4657-2619	1	3/4	1.17	4000	16000	4.7
70905	12M4KH XREEL	4657-2386	220	3/4	1.17	4000	16000	4.7



**GLOBAL M4KH MEGA4000™ HOSE - HIGH-TEMP - SAE 100R19 - MEGATUFF® COVER**

**WIRE BRAID**

RECOMMENDED FOR	High-pressure hydraulic applications at elevated temperatures. Exceeds ISO 18752 Grade C, SAE 100R19 and ISO 11237 R19. Allows for tighter minimum bend radius, increased working pressure and improved impulse cycles than industry standards. Provides greater performance, flexibility, easier routing and plumbing of mobile and stationary hydraulic platforms.
TUBE	Black, oil resistant, synthetic rubber (Nitrile). See Hose Stock Characteristics.
REINFORCEMENT	Two braids of high-tensile steel wire.
COVER	Black, oil, abrasion and weather resistant MegaTuff® cover with color coded layline. Also available in Standard cover. See Hose Stock Characteristics.
TEMPERATURE RANGE	-40°F to +250°F (-40°C to +121°C). For water emulsions see Temperature Limits Table.
COUPLING RECOMMENDATION	GlobalSpiral™ Couplings (-6 through -12) (G20) Section E MegaCrimp® Couplings (G25) Section G (See Crimp Data Manual 428-7365 or eCrimp)



Meets Flame Resistance Acceptance Designation "MSHA 2G" and ISO 11237 R19. MegaTuff® hose lasts up to 300 times longer than standard hose during hose-to-hose and hose-to-metal abrasion tests per ISO 6945. Tested to Industry Leading 600,000 impulse cycles.

Part No.	Description	Product No.	Standard Pack					
85448	4M4KH-MTF X50FT	4657-4093	1	1/4	.55	4000	16000	2.0
70956	4M4KH-MTFXREEL	4657-2157	440	1/4	.55	4000	16000	2.0
85449	6M4KH-MTF X50FT	4657-4094	1	3/8	.70	4000	16000	2.5
70957	6M4KH-MTFXREEL	4657-2159	330	3/8	.70	4000	16000	2.5
85450	8M4KH-MTF X50FT	4657-4095	1	1/2	.82	4000	16000	3.5
70958	8M4KH-MTFXREEL	4657-2160	220	1/2	.82	4000	16000	3.5
85451	10M4KH-MTF X50FT	4657-4096	1	5/8	.99	4000	16000	4.0
70959	10M4KH-MTFXREEL	4657-2161	220	5/8	.99	4000	16000	4.0
85452	12M4KH-MTF X50FT	4657-4097	1	3/4	1.17	4000	16000	4.7
70973	12M4KH-MTFXREEL	4657-2396	190	3/4	1.17	4000	16000	4.7

**GLOBAL M4KL MEGA4000™ POLARFLEX® HOSE - SAE 100R19****WIRE BRAID**

RECOMMENDED FOR	High-pressure hydraulic applications in low-temperature environments. Exceeds ISO 18752 Grade B, SAE 100R19 and ISO 11237 R19. Allows for tighter minimum bend radius, increased working pressure and improved impulse cycles than industry standards. Provides greater performance, flexibility, easier routing and plumbing of mobile and stationary hydraulic platforms.
TUBE	Black, oil resistant (Nitrile). See Hose Stock Characteristics.
REINFORCEMENT	Two braids of high-tensile steel wire.
COVER	Black, oil, abrasion and weather resistant synthetic rubber (Polychloroprene), with color coded layline. See Hose Stock Characteristics.
TEMPERATURE RANGE	-70°F to +212°F (-57°C to +100°C).
COUPLING RECOMMENDATION	GlobalSpiral™ Couplings (-6 through -16) (G20) Section E MegaCrimp® Couplings (-4 through -12) (G25) Section G Stainless Steel Braid Couplings (-4 through -8) (G17) Section H Stainless Steel Spiral Couplings (-12 and -16) (G18) Section F (See Crimp Data Manual 428-7365 or eCrimp)



Meets Flame Resistance Acceptance Designation "MSHA 2G". Tested to Industry Leading 600,000 impulse cycles.

Part No.	Description	Product No.	Standard Pack					
70148	4M4KLXREEL	4657-4470	440	1/4	.54	4000	16000	2.0
70149	5M4KLXREEL	4657-4471	350	5/16	.60	4000	16000	2.3
70150	6M4KLXREEL	4657-4472	330	3/8	.69	4000	16000	2.5
70151	8M4KLXREEL	4657-4473	220	1/2	.82	4000	16000	3.5
70152	10M4KLXREEL	4657-4474	220	5/8	.98	4000	16000	4.0
70153	12M4KLXREEL	4657-4475	220	3/4	1.16	4000	16000	6.0
70154	16M4KLXREEL	4657-4476	165	1	1.52	4000	16000	6.0

**GLOBAL M3K MEGA3000® HOSE - SAE 100R17****WIRE BRAID**

RECOMMENDED FOR	High-pressure hydraulic oil lines. Exceeds ISO 18752 Grade B, SAE 100R17 and ISO 11237 R17 working pressure, minimum bend radius requirements and performance requirements of EN 857 1SC. M3K hose has smaller exterior dimensions and significantly tighter bend radius than other SAE 100R1 and 100R2 hose.
TUBE	Black, oil resistant, synthetic rubber (Nitrile). See Hose Stock Characteristics.
REINFORCEMENT	Braided, high-tensile steel wire. -4, -5, -6 and -8 sizes are one braid; -10, -12 and -16 sizes are two braid.
COVER	Black, oil, abrasion and weather resistant, synthetic rubber (Nitrile and PVC), with color coded layline. Also available with unique abrasion resistant MegaTuff® or XtraTuff® covers. See Hose Stock Characteristics.
TEMPERATURE RANGE	-40°F to +212°F (-40°C to +100°C). For water emulsions see Temperature Limits Table.
COUPLING RECOMMENDATION	GlobalSpiral™ Couplings (-6 through -16) (G20) Section E MegaCrimp® Couplings (G25) Section G Power Crimp® Couplings (-3) Section I Stainless Steel Braid Couplings (G17) Section H (See Crimp Data Manual 428-7365 or eCrimp)



Meets Flame Resistance Acceptance Designation "MSHA 2G" and ISO 11237 R17. Tested to Industry Leading 600,000 impulse cycles.

Part No.	Description	Product No.	Standard Pack					
70352	3M3KXREEL	4657-8068	440	3/16	.43	3250	13000	1.3

**GLOBAL M3K MEGA3000® HOSE - SAE 100R17 - CONTINUED**
**WIRE BRAID - CONTINUED**

Part No.	Description	Product No.	Standard Pack					
85624	4M3K X50FT	4657-4874	1	1/4	.48	3250	13000	1.5
	4M3KXBALE	4657-5743	6000	1/4	.48	3250	13000	1.5
	4M3KXLG REEL	4657-1176	1400	1/4	.48	3250	13000	1.5
70485	4M3KXREEL	4657-1157	440	1/4	.48	3250	13000	1.5
85609	5M3K X50FT	4657-2502	1	5/16	.60	3250	13000	1.8
70575	5M3KXREEL	4657-2216	385	5/16	.60	3250	13000	1.8
85625	6M3K X50FT	4657-4875	1	3/8	.63	3250	13000	2.0
	6M3KXBALE	4657-5744	4500	3/8	.63	3250	13000	2.0
	6M3KXLG REEL	4657-1177	1000	3/8	.63	3250	13000	2.0
70486	6M3KXREEL	4657-1158	330	3/8	.63	3250	13000	2.0
85626	8M3K X50FT	4657-4876	1	1/2	.80	3250	13000	2.8
	8M3KXBALE	4657-5745	2800	1/2	.80	3250	13000	2.8
	8M3KXLG REEL	4657-1178	1000	1/2	.80	3250	13000	2.8
70487	8M3KXREEL	4657-1159	220	1/2	.80	3250	13000	2.8
85627	10M3K X50FT	4657-4877	1	5/8	.99	3250	13000	3.0
	10M3KXBALE	4657-5746	1800	5/8	.99	3250	13000	3.0
	10M3KXLG REEL	4657-0233	800	5/8	.99	3250	13000	3.0
70488	10M3KXREEL	4657-1173	220	5/8	.99	3250	13000	3.0
85628	12M3K X50FT	4657-4878	1	3/4	1.15	3250	13000	3.8
	12M3KXBALE	4657-5747	1250	3/4	1.15	3250	13000	3.8
70489	12M3KXREEL	4657-0679	220	3/4	1.15	3250	13000	3.8
85629	16M3K X50FT	4657-4879	1	1	1.48	3250	13000	4.5
	16M3KXBALE	4657-5748	700	1	1.48	3250	13000	4.5
70490	16M3KXREEL	4657-1163	165	1	1.48	3250	13000	4.5



**GLOBAL M3K MEGA3000® HOSE - SAE 100R17 - MEGATUFF® COVER**

**WIRE BRAID**

RECOMMENDED FOR	High-pressure hydraulic oil lines. Exceeds ISO 18752 Grade B, SAE 100R17 and ISO 11237 R17 working pressure, minimum bend radius requirements and performance requirements of EN 857 1SC. M3K hose has smaller exterior dimensions and significantly tighter bend radius than other SAE 100R1 and 100R2 hose.
TUBE	Black, oil resistant, synthetic rubber (Nitrile). See Hose Stock Characteristics.
REINFORCEMENT	Braided, high-tensile steel wire. -4, -5, -6 and -8 sizes are one braid; -10, -12 and -16 sizes are two braid.
COVER	Black, oil, abrasion and weather resistant MegaTuff® cover with color coded layline. Also available with unique abrasion resistant XtraTuff® or Standard covers. See Hose Stock Characteristics.
TEMPERATURE RANGE	-40°F to +212°F (-40°C to +100°C). For water emulsions see Temperature Limits Table.
COUPLING RECOMMENDATION	GlobalSpiral™ Couplings (-6 through -16) (G20) Section E MegaCrimp® Couplings (G25) Section G Stainless Steel Braid Couplings (G17) Section H (See Crimp Data Manual 428-7365 or eCrimp)



Meets Flame Resistance Acceptance Designation "MSHA 2G" and ISO 11237 R17. MegaTuff® hose lasts up to 300 times longer than standard hose during hose-to-hose and hose-to-metal abrasion tests per ISO 6945. Tested to Industry Leading 600,000 impulse cycles.

Part No.	Description	Product No.	Standard Pack	⊖	⊕	⊙	⊚	⊛
85525	4M3K-MTF X50FT	4657-4025	1	1/4	.48	3250	13000	1.5
	4M3K-MTFXBALE	4657-5769	5600	1/4	.48	3250	13000	1.5
	4M3K-MTFXLG REEL	4657-1180	1400	1/4	.48	3250	13000	1.5
70565	4M3K-MTFXREEL	4657-1181	440	1/4	.48	3250	13000	1.5
85526	6M3K-MTF X50FT	4657-4026	1	3/8	.63	3250	13000	2.0
	6M3K-MTFXBALE	4657-5770	3800	3/8	.63	3250	13000	2.0
	6M3K-MTFXLG REEL	4657-1192	1000	3/8	.63	3250	13000	2.0
70566	6M3K-MTFXREEL	4657-1182	330	3/8	.63	3250	13000	2.0
85527	8M3K-MTF X50FT	4657-4027	1	1/2	.80	3250	13000	2.8
	8M3K-MTFXBALE	4657-5771	2500	1/2	.80	3250	13000	2.8
	8M3K-MTFXLG REEL	4657-1193	1000	1/2	.80	3250	13000	2.8
70567	8M3K-MTFXREEL	4657-1183	330	1/2	.80	3250	13000	2.8
85528	10M3K-MTF X50FT	4657-4028	1	5/8	.99	3250	13000	3.0
	10M3K-MTFXBALE	4657-5772	2500	5/8	.99	3250	13000	3.0
70559	10M3K-MTFXREEL	4657-1184	220	5/8	.99	3250	13000	3.0
85529	12M3K-MTF X50FT	4657-4029	1	3/4	1.15	3250	13000	3.8
70560	12M3K-MTFXREEL	4657-1185	220	3/4	1.15	3250	13000	3.8
85530	16M3K-MTF X50FT	4657-4030	1	1	1.48	3250	13000	4.8
	16M3K-MTFXBALE	4657-5774	800	1	1.48	3250	13000	4.8
70562	16M3K-MTFXREEL	4657-1186	165	1	1.48	3250	13000	4.8





**GLOBAL M3K MEGA3000® HOSE - SAE 100R17 - XTRATUFF® COVER**

**WIRE BRAID**

RECOMMENDED FOR	High-pressure hydraulic oil lines. Exceeds ISO 18752 Grade B, SAE 100R17 and ISO 11237 R17 working pressure, minimum bend radius requirements and performance requirements of EN 857 1SC. M3K hose has smaller exterior dimensions and significantly tighter bend radius than other SAE 100R1 and 100R2 hose.
TUBE	Black, oil resistant, synthetic rubber (Nitrile). See Hose Stock Characteristics.
REINFORCEMENT	Braided, high-tensile steel wire. -4, -5, -6 and -8 sizes are one braid; -10, -12 and -16 sizes are two braid.
COVER	Black, oil, abrasion and weather resistant, synthetic rubber (XtraTuff® Nitrile), with color coded layline. Also available with unique abrasion resistant MegaTuff® or Standard covers. See Hose Stock Characteristics.
TEMPERATURE RANGE	-40°F to +212°F (-40°C to +100°C). For water emulsions see Temperature Limits Table.
COUPLING RECOMMENDATION	GlobalSpiral™ Couplings (-6 through -16) (G20) Section E MegaCrimp® Couplings (G25) Section G Power Crimp® Couplings (-3) Section I Stainless Steel Braid Couplings (G17) Section H (See Crimp Data Manual 428-7365 or eCrimp)



Meets Flame Resistance Acceptance Designation "MSHA 2G" and ISO 11237 R17. Tested to Industry Leading 600,000 impulse cycles. XtraTuff® hose lasts up to 25 times longer than standard hose during hose-to-hose and hose-to-metal abrasion tests per ISO 6945.

Part No.	Description	Product No.	Standard Pack					
70969	3M3K-XTFXREEL	4657-8069	440	3/16	.43	3250	13000	1.3
	4M3K-XTFXBALE	4657-2434	5600	1/4	.48	3250	13000	1.5
70569	4M3K-XTFXREEL	4657-1097	440	1/4	.48	3250	13000	1.5
	5M3K-XTFXBALE	4657-2628	4400	5/16	.60	3250	13000	1.8
	6M3K-XTFXBALE	4657-2627	4800	3/8	.63	3250	13000	2.0
70570	6M3K-XTFXREEL	4657-1098	330	3/8	.63	3250	13000	2.0
	8M3K-XTFXBALE	4657-1099	2500	1/2	.80	3250	13000	2.8
70571	8M3K-XTFXREEL	4657-2248	220	1/2	.80	3250	13000	2.8
70572	10M3K-XTFXREEL	4657-2249	220	5/8	.99	3250	13000	3.0
70573	12M3K-XTFXREEL	4657-2250	220	3/4	1.15	3250	13000	3.8
70574	16M3K-XTFXREEL	4657-2307	165	1	1.48	3250	13000	4.5

**GLOBAL M3KH MEGA3000® HOSE - HIGH-TEMP - SAE 100R17****WIRE BRAID**

RECOMMENDED FOR	Elevated temperature high-pressure hydraulic oil lines. Exceeds ISO 18752 Grade C, SAE 100R17 and ISO 11237 R17 requirements and performance requirements of EN 857 1SC. M3KH hose has smaller exterior dimensions and significantly tighter bend radius than other SAE 100R1 and 100R2 hose.
TUBE	Black, oil resistant, synthetic rubber (Nitrile). See Hose Stock Characteristics.
REINFORCEMENT	Braided, high-tensile steel wire. -4, -5, -6 and -8 sizes are one braid; -10, -12 and -16 sizes are two braid.
COVER	Black, oil, abrasion and weather resistant, synthetic rubber (Polychloroprene), with color coded layline. Also available with unique abrasion resistant MegaTuff® cover. See Hose Stock Characteristics.
TEMPERATURE RANGE	-40°F to +250°F (-40°C to +121°C). For water emulsions see Temperature Limits Table.
COUPLING RECOMMENDATION	GlobalSpiral™ Couplings (-6 through -16) (G20) Section E MegaCrimp® Couplings (G25) Section G (See Crimp Data Manual 428-7365 or eCrimp)



Meets Flame Resistance Acceptance Designation "MSHA 2G" and ISO 11237 R17. Tested to Industry Leading 600,000 impulse cycles.

Part No.	Description	Product No.	Standard Pack					
70898	4M3KHREEL	4657-2664	440	1/4	.48	3250	13000	2.0
70789	5M3KHREEL	4657-4055	330	5/16	.60	3250	13000	2.2
70899	6M3KHREEL	4657-2696	330	3/8	.65	3250	13000	2.5
70953	8M3KHREEL	4657-1360	220	1/2	.80	3250	13000	3.5
70954	10M3KHREEL	4657-1361	220	5/8	.99	3250	13000	4.0
70955	12M3KHREEL	4657-1362	220	3/4	1.15	3250	13000	4.8
70907	16M3KHREEL	4657-1363	165	1	1.48	3250	13000	6.0

**GLOBAL M3KH MEGA3000® HOSE - HIGH-TEMP - SAE 100R17 - MEGATUFF® COVER****WIRE BRAID**

RECOMMENDED FOR	Elevated temperature high-pressure hydraulic oil lines. Exceeds ISO 18752 Grade C, SAE 100R17 and ISO 11237 R17 working pressure, minimum bend radius requirements and performance requirements of EN 857 1SC. M3KH hose has smaller exterior dimensions and significantly tighter bend radius than other SAE 100R1 and 100R2 hose.
TUBE	Black, oil resistant, synthetic rubber (Nitrile). See Hose Stock Characteristics.
REINFORCEMENT	Braided, high-tensile steel wire. -4, -6 and -8 sizes are one braid; -10, -12 and -16 sizes are two braid.
COVER	Black, oil, abrasion and weather resistant MegaTuff® cover with color coded layline. Also available in Standard cover. See Hose Stock Characteristics.
TEMPERATURE RANGE	-40°F to +250°F (-40°C to +121°C). For water emulsions see Temperature Limits Table.
COUPLING RECOMMENDATION	GlobalSpiral™ Couplings (-6 through -16) (G20) Section E MegaCrimp® Couplings (G25) Section G (See Crimp Data Manual 428-7365 or eCrimp)



Meets Flame Resistance Acceptance Designation "MSHA 2G" and ISO 11237 R17. MegaTuff® hose lasts up to 300 times longer than standard hose during hose-to-hose and hose-to-metal abrasion tests per ISO 6945. Tested to Industry Leading 600,000 impulse cycles.

Part No.	Description	Product No.	Standard Pack					
71030	4M3KH-MTFXREEL	4657-2321	440	1/4	.48	3250	13000	2.0

**GLOBAL M3KH MEGA3000® HOSE - HIGH-TEMP - SAE 100R17 - MEGATUFF® COVER - CONTINUED**
**WIRE BRAID - CONTINUED**

Part No.	Description	Product No.	Standard Pack					
71031	6M3KH-MTFXREEL	4657-2323	330	3/8	.63	3250	13000	2.5
71032	8M3KH-MTFXREEL	4657-2324	330	1/2	.80	3250	13000	3.5
71033	10M3KH-MTFXREEL	4657-2325	220	5/8	.99	3250	13000	4.0
71034	12M3KH-MTFXREEL	4657-2326	220	3/4	1.15	3250	13000	4.8
71035	16M3KH-MTFXREEL	4657-2327	165	1	1.48	3250	13000	6.0

**MXT™ MEGASYS® WIRE BRAID HOSE - SAE 100R16**
**WIRE BRAID**

**RECOMMENDED FOR** High-pressure hydraulic oil lines. Meets SAE 100R16 dimensions and performance. Meets SAE 100R17 (6, 8, 10, and 12) dimension and performance. Meets SAE 100R2 performance. Meets SAE 100R19 (6, and 8) performance. MXT hose has smaller exterior dimensions, lower force to bend and significantly tighter bend radius than all SAE specs listed above.



**TUBE** Black, oil resistant, synthetic rubber (Nitrile). See Hose Stock Characteristics.

**REINFORCEMENT** Patent-Pending, Gates-Engineered, high-tensile steel wire braid reinforcement.

**COVER** Black, oil, abrasion and weather resistant, synthetic rubber (nitrile), with color coded layline. See Hose Stock Characteristics.

**TEMPERATURE RANGE** -40°F to +212°F (-40°C to +100°C).

**COUPLING RECOMMENDATION** MegaCrimp® Couplings (-6 through -16) (G25) Section G (See Crimp Data Manual 428-7365 or eCrimp)

Meets Flame Resistance Acceptance Designation "MSHA 2G". Tested to Industry Leading 600,000 impulse cycles.

Part No.	Description	Product No.	Standard Pack					
85047	6MXT X50FT	4657-9799	1	3/8	.68	4800	19200	2.5
70348	6MXTX100REEL	4657-9800	100	3/8	.68	4800	19200	2.5
70336	6MXTXBALE	4657-9661	3000	3/8	.68	4800	19200	2.5
70367	6MXTXLRG REEL	4657-9807	1500	3/8	.68	4800	19200	2.5
70276	6MXTXREEL	4657-9660	400	3/8	.68	4800	19200	2.5
85048	8MXT X50FT	4657-9801	1	1/2	.80	4000	16000	2.75
70354	8MXTX100REEL	4657-9802	100	1/2	.80	4000	16000	2.75
70337	8MXTXBALE	4657-9663	2500	1/2	.80	4000	16000	2.75
70374	8MXTXLRG REEL	4657-9808	1000	1/2	.80	4000	16000	2.75
70283	8MXTXREEL	4657-9662	330	1/2	.80	4000	16000	2.75
85051	10MXT X50FT	4657-9803	1	5/8	.95	3625	14500	3.0
70338	10MXTXBALE	4657-9665	1750	5/8	.95	3625	14500	3.0
70289	10MXTXREEL	4657-9664	220	5/8	.95	3625	14500	3.0
85052	12MXT X50FT	4657-9804	1	3/4	1.08	3125	12500	4.75
70355	12MXTX50REEL	4657-9805	50	3/4	1.08	3125	12500	4.75
70342	12MXTXBALE	4657-9667	1500	3/4	1.08	3125	12500	4.75
70327	12MXTXREEL	4657-9666	220	3/4	1.08	3125	12500	4.75
85053	16MXTX50FT	4657-9806	1	1	1.38	2400	9600	6.0
70344	16MXTXBALE	4657-9669	1200	1	1.38	2400	9600	6.0
70335	16MXTXREEL	4657-9668	165	1	1.38	2400	9600	6.0



**M2T® MEGAFLEX® 2-WIRE BRAID HOSE - SAE 100R16**

**WIRE BRAID**

RECOMMENDED FOR	High-pressure hydraulic oil lines. Exceeds SAE 100R16, SAE 100R2, ISO 11237 2SC R16 and ISO 1436 2SN R2 requirements and performance requirements of EN 857 2SC and EN 853 2SN. M2T hose has smaller exterior dimensions and significantly tighter bend radius.
TUBE	Black, oil resistant, synthetic rubber (Nitrile). See Hose Stock Characteristics.
REINFORCEMENT	Two braids of high-tensile steel wire.
COVER	Black, oil, abrasion and weather resistant, synthetic rubber (Nitrile and PVC), with color coded layline. Also available with unique abrasion resistant MegaTuff® or XtraTuff® covers. See Hose Stock Characteristics.
TEMPERATURE RANGE	-40°F to +212°F (-40°C to +100°C). For water emulsions see Temperature Limits Table.
COUPLING RECOMMENDATION	GlobalSpiral™ Couplings (-6 through -16) (G20) Section E GlobalSpiral™ Plus Couplings (-24 and -32) (G22) Section E MegaCrimp® Couplings (-4 through -20) (G25) Section G Stainless Steel Braid Couplings (-4 through -16) (G17) Section H Stainless Steel Spiral Couplings (-20 and -24) (G18) Section F (See Crimp Data Manual 428-7365 or eCrimp)



Meets Flame Resistance Acceptance Designation "MSHA 2G" and ISO 11237 2SC R16. Tested to Industry Leading 600,000 impulse cycles.

Part No.	Description	Product No.	Standard Pack	⊖	⊕	⊖	⊕	⊖
85600	4M2T X50FT	4657-1553	1	1/4	.56	6000	24000	1.5
71102	4M2TX150REEL	4657-4422	150	1/4	.56	6000	24000	1.5
	4M2TXBALE	4657-5728	5600	1/4	.56	6000	24000	1.5
70390	4M2TXREEL	4657-1552	550	1/4	.56	6000	24000	1.5
85601	6M2T X50FT	4657-1550	1	3/8	.70	5000	20000	2.0
70260	6M2TX100REEL	4657-4607	100	3/8	.70	5000	20000	2.0
	6M2TXBALE	4657-5729	3000	3/8	.69	5000	20000	2.0
	6M2TXLRG REEL	4657-1492	1500	3/8	.70	5000	20000	2.0
70391	6M2TXREEL	4657-1555	385	3/8	.70	5000	20000	2.0
85602	8M2TX50FT	4657-1561	1	1/2	.82	4300	17200	2.8
70261	8M2TX100REEL	4657-4608	100	1/2	.82	4300	17200	2.8
	8M2TXBALE	4657-5730	2500	1/2	.82	4300	17200	2.8
	8M2TXLRG REEL	4657-1493	1000	1/2	.82	4300	17200	2.8
70392	8M2TXREEL	4657-1559	330	1/2	.82	4300	17200	2.8
85603	10M2T X50FT	4657-1564	1	5/8	.95	3800	15200	3.0
	10M2TXBALE	4657-5577	1750	5/8	.95	3800	15200	3.0
70393	10M2TXREEL	4657-1563	220	5/8	.95	3800	15200	3.0
85604	12M2T X50FT	4657-1568	1	3/4	1.11	3500	14000	3.8
70262	12M2TX50REEL	4657-4609	50	3/4	1.11	3500	14000	3.8
	12M2TXBALE	4657-5732	1500	3/4	1.11	3500	14000	3.8
70394	12M2TXREEL	4657-1567	220	3/4	1.11	3500	14000	3.8
85605	16M2T X50FT	4657-1572	1	1	1.39	2500	10000	4.5
70395	16M2TXREEL	4657-1571	165	1	1.39	2500	10000	4.5
80302	20M2T X25FT	4657-4540	1	1 1/4	1.67	2300	9200	8.3
70025	20M2TXCTN	4657-4534	120	1 1/4	1.67	2300	9200	8.3
80048	24M2T X25FT	4657-4610	1	1 1/2	2.00	2000	8000	10.0
80303	24M2T X50FT	4657-4541	1	1 1/2	2.00	2000	8000	10.0
70145	24M2TXCTN	4657-4491	120	1 1/2	2.00	2000	8000	10.0
80049	32M2T X25FT	4657-4611	1	2	2.53	1500	6000	12.5
80304	32M2T X50FT	4657-4542	1	2	2.53	1500	6000	12.5
70146	32M2TXCTN	4657-4492	120	2	2.53	1500	6000	12.5



**M2T® MEGAFLEX® 2-WIRE BRAID HOSE - SAE 100R16 - MEGATUFF® COVER**

**WIRE BRAID**

RECOMMENDED FOR	Ultra high abrasion resistant high-pressure hydraulic oil lines. Exceeds SAE 100R16, SAE 100R2, ISO 11237 2SC R16 and ISO 1436 2SN R2 working pressure, minimum bend radius requirements and performance requirements of EN 857 2SC and EN 853 2SN. M2T hose has smaller exterior dimensions and significantly tighter bend radius.
TUBE	Black, oil resistant, synthetic rubber (Nitrile). See Hose Stock Characteristics.
REINFORCEMENT	Two braids of high-tensile steel wire.
COVER	Black, oil, abrasion and weather resistant MegaTuff® cover with color coded layline. Also available with unique abrasion resistant XtraTuff® or Standard covers. See Hose Stock Characteristics.
TEMPERATURE RANGE	-40°F to +212°F (-40°C to +100°C). For water emulsions see Temperature Limits Table.
COUPLING RECOMMENDATION	GlobalSpiral™ Couplings (-6 through -16) (G20) Section E MegaCrimp® Couplings (G25) Section G Stainless Steel Braid Couplings (-4 through -16) (G17) Section H (See Crimp Data Manual 428-7365 or eCrimp)



Meets Flame Resistance Acceptance Designation "MSHA 2G" and ISO 11237 2SC R16. MegaTuff® hose lasts up to 300 times longer than standard hose during hose-to-hose and hose-to-metal abrasion tests per ISO 6945. Tested to Industry Leading 600,000 impulse cycles.

Part No.	Description	Product No.	Standard Pack	⊖	⊕	⊖	⊕	⊖
85534	4M2T-MTF X50FT	4657-4034	1	1/4	.56	6000	24000	1.5
	4M2T-MTFXBALE	4657-5764	5600	1/4	.56	6000	24000	1.5
70387	4M2T-MTFXREEL	4657-0222	350	1/4	.56	6000	24000	1.5
85535	6M2T-MTF X50FT	4657-4035	1	3/8	.70	5000	20000	2.0
	6M2T-MTFXBALE	4657-5765	2400	3/8	.70	5000	20000	2.0
70388	6M2T-MTFXREEL	4657-0223	330	3/8	.70	5000	20000	2.0
85536	8M2T-MTF X50FT	4657-4036	1	1/2	.82	4300	17200	2.8
	8M2T-MTFXBALE	4657-5766	2200	1/2	.82	4300	17200	2.8
70389	8M2T-MTFXREEL	4657-0224	330	1/2	.82	4300	17200	2.8
85537	10M2T-MTF X50FT	4657-4037	1	5/8	.95	3800	15200	3.0
70407	10M2T-MTFXREEL	4657-0225	220	5/8	.95	3800	15200	3.0
85538	12M2T-MTF X50FT	4657-4038	1	3/4	1.11	3500	14000	3.8
70408	12M2T-MTFXREEL	4657-0226	220	3/4	1.11	3500	14000	3.8
85539	16M2T-MTF X50FT	4657-4039	1	1	1.39	2500	10000	4.5
70409	16M2T-MTFXREEL	4657-0227	165	1	1.39	2500	10000	4.5





**M2T® MEGAFLEX® 2-WIRE BRAID HOSE - SAE 100R16 - XTRATUFF® COVER**

**WIRE BRAID**

RECOMMENDED FOR	High-pressure hydraulic oil lines. Exceeds SAE 100R16, SAE 100R2, ISO 11237 2SC R16 and ISO 1436 2SN R2 working pressure, minimum bend radius requirements and performance requirements of EN 857 2SC and EN 853 2SN. M2T hose has smaller exterior dimensions and significantly tighter bend radius.
TUBE	Black, oil resistant, synthetic rubber (Nitrile). See Hose Stock Characteristics.
REINFORCEMENT	Two braids of high-tensile steel wire.
COVER	Black, oil, abrasion and weather resistant, synthetic rubber (XtraTuff® Nitrile), with color coded layline. Also available with unique abrasion resistant MegaTuff® or Standard covers. See Hose Stock Characteristics.
TEMPERATURE RANGE	-40°F to +212°F (-40°C to +100°C). For water emulsions see Temperature Limits Table.
COUPLING RECOMMENDATION	GlobalSpiral™ Couplings (-6 through -16) (G20) Section E GlobalSpiral™ Plus Couplings (-24 and -32) (G22) Section E MegaCrimp® Couplings (G25) Section G Stainless Steel Braid Couplings (G17) Section H (See Crimp Data Manual 428-7365 or eCrimp)



Meets Flame Resistance Acceptance Designation "MSHA 2G" and ISO 11237 2SC R16. Tested to Industry Leading 600,000 impulse cycles. XtraTuff® hose lasts up to 25 times longer than standard hose during hose-to-hose and hose-to-metal abrasion tests per ISO 6945.

Part No.	Description	Product No.	Standard Pack	⊖	⊕	⊖	⊕	⊖
71061	4M2T-XTFXREEL	4657-4138	350	1/4	.56	6000	24000	1.5
71038	6M2T-XTFXREEL	4657-4302	330	3/8	.70	5000	20000	2.0
71040	8M2T-XTFXREEL	4657-4304	330	1/2	.82	4300	17200	2.8
71043	10M2T-XTFXREEL	4657-4307	220	5/8	.95	3800	15200	3.0
71046	12M2T-XTFXREEL	4657-4310	220	3/4	1.11	3500	14000	3.8
71049	16M2T-XTFXREEL	4657-4313	165	1	1.39	2500	10000	4.5
70221	20M2T-XTFXCTN	4657-4651	130	1 1/4	1.67	2300	9200	8.3
70100	24M2T-XTFXCTN	4657-4652	130	1 1/2	2.00	2000	8000	10.0
70101	32M2T-XTFXCTN	4657-4653	130	2	2.53	1500	6000	12.5



**CM2TDL MEGAFLEX® CONNECTED DUAL-LINE 2-WIRE BRAID - SAE 100R16 - XTRATUFF® COVER**

**WIRE BRAID**

RECOMMENDED FOR	High abrasive high-pressure hydraulic oil lines joined together for easier plumbing and routing. Meets SAE 100R16 requirements. CM2T hose has smaller exterior dimensions and significantly tighter bend radius. Exceeds performance standards of EN 857 2SC and ISO/DIS 1436.
TUBE	Black, oil resistant, synthetic rubber (Nitrile). See Hose Stock Characteristics.
REINFORCEMENT	Two braids of high-tensile steel wire.
COVER	Black, oil, abrasion and weather resistant, synthetic rubber (XtraTuff® Nitrile), with color coded layline. See Hose Stock Characteristics.
TEMPERATURE RANGE	-40°F to +212°F (-40°C to +100°C). For water emulsions see Temperature Limits Table.
COUPLING RECOMMENDATION	GlobalSpiral™ Couplings (G20) Section E MegaCrimp® Couplings (G25) Section G (See Crimp Data Manual 428-7365 or eCrimp)



Meets Flame Resistance Acceptance Designation "MSHA 2G". Tested to Industry Leading 600,000 impulse cycles.

Part No.	Description	Product No.	Standard Pack	⊖	⊕	⊖	⊕	⊕
85389	6CM2TDL-XTF X50FT	4657-4980	1	3/8	.70	4800	19200	3.5
71151	6CM2TDL-XTFXCTN	4657-4974	215	3/8	.70	4800	19200	3.5
85390	8CM2TDL-XTF X50FT	4657-4981	1	1/2	.82	4000	16000	5.0
71152	8CM2TDL-XTFXCTN	4657-4975	180	1/2	.82	4000	16000	5.0

**GLOBAL G2 2-WIRE BRAID HOSE - SAE 100R2 TYPE AT**

**WIRE BRAID**

RECOMMENDED FOR	High-pressure hydraulic oil lines. Meets or exceeds the requirements of SAE 100R2, ISO 1436 2SN R2 and EN 853 2SN.
TUBE	Black, oil resistant, synthetic rubber (Nitrile). See Hose Stock Characteristics.
REINFORCEMENT	Two braids of high-tensile steel wire.
COVER	Black, oil and abrasion resistant, synthetic rubber (Nitrile and PVC). See Hose Stock Characteristics.
TEMPERATURE RANGE	-40°F to +212°F (-40°C to +100°C). For water emulsions see Temperature Limits Table.
COUPLING RECOMMENDATION	Power Attachable Type T Couplings (-4 through -16) (G28) Section J GlobalSpiral™ Couplings (-6 through -16) (G20) Section E MegaCrimp® Couplings (-4 through -16) (G25) Section G Power Crimp® Couplings (-3) Section I Stainless Steel Braid Couplings (G17) Section H (See Crimp Data Manual 428-7365 or eCrimp)



Meets Flame Resistance Acceptance Designation "MSHA 2G".

Part No.	Description	Product No.	Standard Pack	⊖	⊕	⊖	⊕	⊕
86620	3G2 X50FT	4657-0029	1	3/16	.52	6025	24100	3.5
70233	3G2XREEL	4657-2182	440	3/16	.52	6025	24100	3.5
86621	4G2 X50FT	4657-4941	1	1/4	.59	5800	23200	4.0
71101	4G2X150REEL	4657-4421	150	1/4	.59	5800	23200	4.0
	4G2XBALE	4657-5708	4000	1/4	.59	5800	23200	4.0
70605	4G2XREEL	4657-0125	550	1/4	.59	5800	23200	4.0
86622	6G2 X50FT	4657-4916	1	3/8	.74	4800	19200	5.0
86632	6G2 X100FT	4657-4906	1	3/8	.74	4800	19200	5.0
	6G2XBALE	4657-5709	3000	3/8	.74	4800	19200	5.0



## GLOBAL G2 2-WIRE BRAID HOSE - SAE 100R2 TYPE AT - CONTINUED

## WIRE BRAID - CONTINUED

Part No.	Description	Product No.	Standard Pack					
70606	6G2XREEL	4657-0126	400	3/8	.74	4800	19200	5.0
86623	8G2 X50FT	4657-4918	1	1/2	.86	4000	16000	7.0
86634	8G2 X100FT	4657-4908	1	1/2	.86	4000	16000	7.0
	8G2XBALE	4657-5710	2250	1/2	.86	4000	16000	7.0
70607	8G2XREEL	4657-0127	330	1/2	.86	4000	16000	7.0
86626	10G2 X50FT	4657-1965	1	5/8	.99	3625	14500	8.0
	10G2XBALE	4657-5711	1800	5/8	.99	3625	14500	8.0
70610	10G2XREEL	4657-0132	220	5/8	.99	3625	14500	8.0
86624	12G2 X50FT	4657-4943	1	3/4	1.15	3100	12400	9.5
86635	12G2 X50FT REEL	4657-4909	1	3/4	1.15	3100	12400	9.5
	12G2XBALE	4657-5712	1250	3/4	1.15	3100	12400	9.5
70608	12G2XREEL	4657-0128	220	3/4	1.15	3100	12400	9.5
86625	16G2 X50FT	4657-4945	1	1	1.48	2400	9600	12.0
	16G2XBALE	4657-1094	700	1	1.48	2400	9600	12.0
70609	16G2XREEL	4657-0129	165	1	1.48	2400	9600	12.0

## GLOBAL G2H HIGH-TEMP 2-WIRE BRAID HOSE - SAE 100R2 TYPE AT

## WIRE BRAID

RECOMMENDED FOR	High-temperature high-pressure hydraulic oil lines. Meets or exceeds the requirements of SAE 100R2, ISO 1436 2SN R2 and EN 853 2SN.
TUBE	Black, oil resistant, synthetic rubber (Nitrile). See Hose Stock Characteristics.
REINFORCEMENT	Two braids of high-tensile steel wire.
COVER	Black, oil resistant, synthetic rubber (CSM). Also available with unique abrasion resistant MegaTuff® cover. See Hose Stock Characteristics.
TEMPERATURE RANGE	-40°F to +275°F (-40°C to +135°C) constant and +300°F (+149°C) intermittent (up to 10% of operating time). For water emulsions see Temperature Limits Table.
COUPLING RECOMMENDATION	Field Attachable Type T Couplings (-20 and -24) (G28) Section J GlobalSpiral™ Couplings (-20) (G20) Section E GlobalSpiral™ Plus Couplings (-24 and -32) (G22) Section E MegaCrimp® Couplings (-20) (G25) Section G Stainless Steel Braid Couplings (-24 and -32) (G17) Section H (See Crimp Data Manual 428-7365 or eCrimp)



Meets Flame Resistance Acceptance Designation "MSHA 2G".

Part No.	Description	Product No.	Standard Pack					
86520	20G2H X50FT	4657-0925	1	1 1/4	1.86	1825	6500	16.5
70230	20G2HXCTN	4657-0930	120	1 1/4	1.86	1825	6500	16.5
85427	24G2H X25FT	4657-4331	1	1 1/2	2.11	1300	5200	20.0
86518	24G2H X50FT	4657-0927	1	1 1/2	2.11	1300	5200	20.0
70241	24G2HXCTN	4657-0931	120	1 1/2	2.11	1300	5200	20.0
85428	32G2H X25FT	4657-4332	1	2	2.62	1175	4700	25.0
86519	32G2H X50FT	4657-0926	1	2	2.62	1175	4700	25.0
70242	32G2HXCTN	4657-0932	120	2	2.62	1175	4700	25.0



**GLOBAL G2H HIGH-TEMP - MEGATUFF® COVER - SAE 100R2 TYPE AT**

**WIRE BRAID**

RECOMMENDED FOR	High-temperature high-pressure hydraulic oil lines. Meets or exceeds the requirements of SAE 100R2, ISO 1436 2SN R2 and EN 853 2SN.
TUBE	Black, oil resistant, synthetic rubber (Nitrile). See Hose Stock Characteristics.
REINFORCEMENT	Two braids of high-tensile steel wire.
COVER	Black, oil and abrasion resistant, synthetic rubber and MegaTuff® cover. Also available in Standard cover. See Hose Stock Characteristics.
TEMPERATURE RANGE	-40°F to +275°F (-40°C to +135°C) constant and +300°F (+149°C) intermittent (up to 10% of operating time). For water emulsions see Temperature Limits Table.
COUPLING RECOMMENDATION	Field Attachable Type T Couplings (-20 and -24) (G28) Section J GlobalSpiral™ Couplings (-20) (G20) Section E GlobalSpiral™ Plus Couplings (-24 and -32) (G22) Section E MegaCrimp® Couplings (-20) (G25) Section G Stainless Steel Braid Couplings (-24 and -32) (G17) Section H (See Crimp Data Manual 428-7365 or eCrimp)



Meets Flame Resistance Acceptance Designation "MSHA 2G". MegaTuff® hose lasts up to 300 times longer than standard hose during hose-to-hose and hose-to-metal abrasion tests per ISO 6945.

Part No.	Description	Product No.	Standard Pack					
70897	20G2H-MTFXCTN	4657-2573	100	1 1/4	1.87	1825	6500	16.5
70188	24G2H-MTFXCTN	4657-2151	100	1 1/2	2.15	1300	5200	20.0
70189	32G2H-MTFXCTN	4657-2152	100	2	2.65	1175	4700	25.0

**GLOBAL G2XH 2-WIRE BRAID XTREME® HEAT HOSE - SAE 100R2 TYPE AT**

**WIRE BRAID**

RECOMMENDED FOR	Extremely high-temperature high-pressure hydraulic applications where pressure or temperature requirements exceed SAE 100R2, ISO 1436 2SN R2 and EN 853 2SN or where resistance to either petroleum-base or phosphate ester fluids is required. Meets SAE J1942 requirements.
TUBE	Black, oil and chemical resistant, synthetic rubber (CPE). See Hose Stock Characteristics.
REINFORCEMENT	Two braids of high-tensile steel wire.
COVER	Blue, oil and abrasion resistant, thin synthetic rubber (CSM). See Hose Stock Characteristics.
TEMPERATURE RANGE	Petroleum-base fluids: -40°F to +300°F (-40°C to +149°C). Phosphate esters fluids as recommended by the fluid manufacturer, but within a range of -40°F to +212°F. For water emulsions: Max. +225°F Pressure lines, Max +180°F Return lines.
COUPLING RECOMMENDATION	GlobalSpiral™ Couplings (G20) Section E GlobalSpiral™ Plus Couplings (-24 and -32) (G22) Section E MegaCrimp® Couplings (G25) Section G Stainless Steel Braid Couplings (-24 and -32) (G17) Section H (See Crimp Data Manual 428-7365 or eCrimp)



Meets Flame Resistance Acceptance Designation "MSHA 2G".

Part No.	Description	Product No.	Standard Pack					
85798	4G2XH X50FT	4657-4008	1	1/4	.59	6000	24000	4.0
70966	4G2XH XREEL	4657-2541	550	1/4	.59	6000	24000	4.0
85799	6G2XH X50FT	4657-4009	1	3/8	.74	5000	20000	5.0
70967	6G2XH XREEL	4657-2542	400	3/8	.74	5000	20000	5.0
85800	8G2XH X50FT	4657-4010	1	1/2	.86	4250	17000	7.0



## GLOBAL G2XH 2-WIRE BRAID XTREME® HEAT HOSE - SAE 100R2 TYPE AT - CONTINUED

## WIRE BRAID - CONTINUED

Part No.	Description	Product No.	Standard Pack					
70968	8G2XH X50FT	4657-2543	330	1/2	.86	4250	17000	7.0
85801	10G2XH X50FT	4657-4011	1	5/8	.99	3625	14500	8.0
70803	10G2XH XREEL	4657-2544	220	5/8	.99	3625	14500	8.0
85802	12G2XH X50FT	4657-4012	1	3/4	1.15	3100	12400	9.5
70909	12G2XH XREEL	4657-2545	220	3/4	1.15	3100	12400	9.5
85803	16G2XH X50FT	4657-4013	1	1	1.48	2500	10000	12.0
70878	16G2XH XREEL	4657-2546	165	1	1.48	2500	10000	12.0
70990	20G2XH XCTN	4657-4988	130	1 1/4	1.86	2250	9000	16.5
70988	24G2XH XCTN	4657-4989	130	1 1/2	2.15	1800	7200	20.0
70989	32G2XH XCTN	4657-4990	130	2	2.65	1500	6000	25.0

## GLOBAL G2L POLARFLEX® HOSE - SAE 100R2 TYPE AT

## WIRE BRAID

RECOMMENDED FOR	Low-temperature high-pressure hydraulic oil lines. Meets or exceeds the requirements of SAE 100R2, ISO 1436 2SN R2 and EN 853 2SN. Qualified to Mil-DTL-13531 Type II Class B.
TUBE	Black, oil resistant, synthetic rubber (Nitrile). See Hose Stock Characteristics.
REINFORCEMENT	Two braids of high-tensile steel wire.
COVER	Black, oil and abrasion resistant, thin synthetic rubber (Polychloroprene). See Hose Stock Characteristics.
TEMPERATURE RANGE	-70°F to +212°F (-57°C to +100°C). For water emulsions see Temperature Limits Table.
COUPLING RECOMMENDATION	Field Attachable Type T Couplings (-4 through -24) (G28) Section J GlobalSpiral™ Couplings (-6 through -20) (G20) Section E GlobalSpiral™ Plus Couplings (-24 and -32) (G22) Section E MegaCrimp® Couplings (G25) Section G (See Crimp Data Manual 428-7365 or eCrimp)



Meets Flame Resistance Acceptance Designation "MSHA 2G".

Part No.	Description	Product No.	Standard Pack					
85732	4G2L X50FT	4657-2475	1	1/4	.59	5800	23200	4.0
70286	4G2L XREEL	4657-2202	440	1/4	.59	5800	23200	4.0
85733	6G2L X50FT	4657-2476	1	3/8	.74	4800	19200	5.0
70287	6G2L XREEL	4657-2203	385	3/8	.74	4800	19200	5.0
85734	8G2L X50FT	4657-2477	1	1/2	.86	4000	16000	7.0
70290	8G2L XREEL	4657-2204	330	1/2	.86	4000	16000	7.0
85735	10G2L X50FT	4657-2478	1	5/8	.99	3625	14500	8.0
70291	10G2L XREEL	4657-2205	220	5/8	.99	3625	14500	8.0
85736	12G2L X50FT	4657-2479	1	3/4	1.15	3100	12400	9.5
70292	12G2L XREEL	4657-2206	220	3/4	1.15	3100	12400	9.5
85737	16G2L X50FT	4657-2480	1	1	1.48	2400	9600	12.0
70293	16G2L XREEL	4657-2207	165	1	1.48	2400	9600	12.0
85707	20G2L X50FT	4657-4102	1	1 1/4	1.84	1825	7300	16.5
70294	20G2L XCTN	4657-2208	120	1 1/4	1.84	1825	7300	16.5
85708	24G2L X50FT	4657-4103	1	1 1/2	2.12	1300	5200	20.0
70314	24G2L XCTN	4657-2315	120	1 1/2	2.12	1300	5200	20.0
85709	32G2L X50FT	4657-4104	1	2	2.62	1175	4700	25.0
70315	32G2L XCTN	4657-2316	120	2	2.62	1175	4700	25.0





**M-XP™ MILLION IMPULSE XTRA PERFORMANCE WIRE BRAID HOSE**

**WIRE BRAID**

RECOMMENDED FOR	High-pressure, high impulse life hydraulic applications. Provides tighter than standard minimum bend radius and greater flexibility for easier plumbing.
TUBE	Black, oil resistant, synthetic rubber (Nitrile). See Hose Stock Characteristics.
REINFORCEMENT	Two braids of high-tensile steel wire.
COVER	Black, oil, abrasion and weather resistant, synthetic rubber (Nitrile and PVC -4 and -6), (Polychloroprene -8 through -12). See Hose Stock Characteristics.
TEMPERATURE RANGE	-40°F to +212°F (-40°C to +100°C). For water emulsions see Temperature Limits Table.
COUPLING RECOMMENDATION	GlobalSpiral™ Couplings (-6 through -12) (G20) Section E MegaCrimp® Couplings (G25) Section G (See Crimp Data Manual 428-7365 or eCrimp)



Meets Flame Resistance Acceptance Designation "MSHA 2G". Tested to Industry Leading 1,000,000 impulse cycles.

Part No.	Description	Product No.	Standard Pack	⊖	⊕	⊙	⊙	⊙
71105	4M-XPXREEL	4657-4216	440	1/4	.55	4000	16000	2.0
71106	6M-XPXREEL	4657-4217	330	3/8	.70	4000	16000	2.5
71107	8M-XPXREEL	4657-4218	220	1/2	.82	4000	16000	3.5
71108	10M-XPXREEL	4657-4219	220	5/8	.96	4000	16000	4.0
71109	12M-XPXREEL	4657-4220	220	3/4	1.17	4000	16000	4.7

**GLOBAL G1 1-WIRE BRAID HOSE - SAE 100R1 TYPE AT**

**WIRE BRAID**

RECOMMENDED FOR	Medium-pressure hydraulic lines. Meets or exceeds the requirements of SAE 100R1, ISO 1436 1SNR1 and EN 853 1SN.
TUBE	Black, oil resistant, synthetic rubber (Nitrile). See Hose Stock Characteristics.
REINFORCEMENT	One braid of high-tensile steel wire.
COVER	Black, oil and abrasion resistant, synthetic rubber (Nitrile and PVC). See Hose Stock Characteristics.
TEMPERATURE RANGE	-40°F to +212°F (-40°C to +100°C). For water emulsions see Temperature Limits Table.
COUPLING RECOMMENDATION	Field Attachable Type T Couplings (G27) Section J GlobalSpiral™ Couplings (-6 through -20) (G20) Section E GlobalSpiral™ Plus Couplings (-24 and -32) (G22) Section E MegaCrimp® Couplings (-4 through -20) (G25) Section G Power Crimp® Couplings (-3) Section I Power Crimp® Grease Couplings (-3) Section I Stainless Steel Braid Couplings (except -3, -5 & -16) (G17) Section H (See Crimp Data Manual 428-7365 or eCrimp)



Meets Flame Resistance Acceptance Designation "MSHA 2G".

Part No.	Description	Product No.	Standard Pack	⊖	⊕	⊙	⊙	⊙
	3G1XBALE	4657-5700	7600	3/16	.47	3625	14500	3.0
70200	3G1XCTN	4657-0618	800	3/16	.47	3625	14500	3.0
70611	3G1XREEL	4657-0599	440	3/16	.47	3625	14500	3.0
86611	4G1 X50FT	4657-4940	1	1/4	.53	3275	13100	4.0
	4G1XBALE	4657-5717	5600	1/4	.53	3275	13100	4.0
70600	4G1XREEL	4657-0120	440	1/4	.53	3275	13100	4.0
70199	5G1XCTN	4657-0031	550	5/16	.60	3125	12500	4.5



## GLOBAL G1 1-WIRE BRAID HOSE - SAE 100R1 TYPE AT - CONTINUED

## WIRE BRAID - CONTINUED

Part No.	Description	Product No.	Standard Pack					
70970	5G1XREEL	4657-0116	350	5/16	.60	3125	12500	4.5
86612	6G1 X50FT	4657-4915	1	3/8	.68	2600	10400	5.0
86631	6G1 X100FT	4657-4905	1	3/8	.68	2600	10400	5.0
	6G1XBALE	4657-5703	3800	3/8	.68	2600	10400	5.0
70601	6G1XREEL	4657-0121	385	3/8	.68	2600	10400	5.0
86613	8G1 X50FT	4657-4917	1	1/2	.80	2325	9300	7.0
86633	8G1 X100FT	4657-4907	1	1/2	.80	2325	9300	7.0
	8G1XBALE	4657-5704	2800	1/2	.80	2325	9300	7.0
	8G1XLG REEL	4657-2645	500	1/2	.80	2325	9300	7.0
70602	8G1XREEL	4657-0122	330	1/2	.80	2325	9300	7.0
	10G1XBALE	4657-5705	1550	5/8	.93	1900	7600	8.0
70612	10G1XREEL	4657-0115	220	5/8	.93	1900	7600	8.0
86614	12G1 X50FT	4657-4942	1	3/4	1.09	1525	6100	9.0
	12G1XBALE	4657-5706	1400	3/4	1.09	1525	6100	9.0
70603	12G1XREEL	4657-0123	220	3/4	1.09	1525	6100	9.0
86615	16G1 X50FT	4657-4944	1	1	1.40	1300	5200	12.0
	16G1XBALE	4657-5707	700	1	1.40	1300	5200	12.0
70604	16G1XREEL	4657-0124	165	1	1.40	1300	5200	12.0
	20G1XBALE	4657-5702	600	1 1/4	1.71	925	3700	16.0
70271	20G1XCTN	4657-0646	120	1 1/4	1.71	925	3700	16.0
70278	24G1XCTN	4657-2489	120	1 1/2	1.96	725	2900	20.0
70279	32G1XCTN	4657-2490	120	2	2.51	600	2400	25.0

## GLOBAL G1H 1-WIRE BRAID HOSE - HIGH-TEMP - SAE 100R1 TYPE AT

## WIRE BRAID

RECOMMENDED FOR	High-temperature medium-pressure hydraulic oil lines. Meets or exceeds SAE 100R1 Type AT 2003 Revision.
TUBE	Black, oil resistant, synthetic rubber (Nitrile). See Hose Stock Characteristics.
REINFORCEMENT	One braid of high-tensile steel wire.
COVER	Black, oil and abrasion resistant, synthetic rubber (CSM). See Hose Stock Characteristics.
TEMPERATURE RANGE	-40°F to +275°F (-40°C to +135°C) constant and +300°F (+149°C) intermittent (up to 10% of operating time). For water emulsions see Temperature Limits Table.
COUPLING RECOMMENDATION	GlobalSpiral™ Couplings (G20) Section E GlobalSpiral™ Plus Couplings (-24 and -32) (G22) Section E MegaCrimp® Couplings (G25) Section G Stainless Steel Braid Couplings (-4 through -32, except -16 & -24) (G17) Section H (See Crimp Data Manual 428-7365 or eCrimp)



Meets Flame Resistance Acceptance Designation "MSHA 2G".

Part No.	Description	Product No.	Standard Pack					
85922	4G1H X50FT	4657-4105	1	1/4	.53	2750	11000	4.0
70755	4G1HXREEL	4657-2175	440	1/4	.53	2750	11000	4.0
85923	6G1H X50FT	4657-4106	1	3/8	.69	2250	9000	5.0
70756	6G1HXREEL	4657-2176	385	3/8	.69	2250	9000	5.0





**GLOBAL G1H 1-WIRE BRAID HOSE - HIGH-TEMP - SAE 100R1 TYPE AT - CONTINUED**
**WIRE BRAID - CONTINUED**

Part No.	Description	Product No.	Standard Pack					
85924	8G1H X50FT	4657-4107	1	1/2	.80	2000	8000	7.0
70757	8G1HXREEL	4657-2177	330	1/2	.80	2000	8000	7.0
85925	10G1H X50FT	4657-4108	1	5/8	.94	1500	6000	8.0
70758	10G1HXREEL	4657-2178	220	5/8	.94	1500	6000	8.0
85938	12G1H X50FT	4657-2617	1	3/4	1.10	1250	5000	9.5
	12G1HXBAL	4657-2536	1500	3/4	1.10	1250	5000	9.5
70759	12G1HXREEL	4657-2179	220	3/4	1.10	1250	5000	9.5
85934	16G1H X50FT	4657-4109	1	1	1.41	1000	4000	12.0
70760	16G1HXREEL	4657-2180	165	1	1.41	1000	4000	12.0
85935	20G1H X50FT	4657-4110	1	1 1/4	1.71	925	3700	16.0
70211	20G1HXCTN	4657-0940	120	1 1/4	1.71	925	3700	16.0
85936	24G1H X50FT	4657-4111	1	1 1/2	1.96	725	2900	20.0
70212	24G1HXCTN	4657-0934	120	1 1/2	1.96	725	2900	20.0
85937	32G1H X50FT	4657-4112	1	2	2.51	600	2400	25.0
70213	32G1HXCTN	4657-0935	120	2	2.51	600	2400	25.0

**TH7 HYDRAULIC HOSE - SAE 100R7**
**THERMOPLASTIC**

RECOMMENDED FOR	Petroleum, water-base and synthetic hydraulic fluids. Applications include: power and telephone mobile equipment (cherry pickers), lubrication lines, blowout preventer control lines, hydraulic lifts and farm and construction machinery. TH7 hose meets or exceeds performance requirements of SAE 100R7 with a significantly tighter bend radius.
TUBE	100% seamless Nylon that easily handles a broad range of hydraulic fluids, including phosphate esters and water glycol. See Hose Stock Characteristics.
REINFORCEMENT	Synthetic fiber.
COVER	Black Urethane that resists hydraulic fluids, high temperatures, aging and weathering. Black TH7 is perforated for use in general hydraulic and pneumatic service.
TEMPERATURE RANGE	-65°F to +200°F (-54°C to +93°C) continuous service for petroleum and synthetic oils. Maximum of +158°F (+70°C) for water, water/oil emulsions and water glycol.
COUPLING RECOMMENDATION	MegaCrimp® Couplings (G25) Section G Swage PCTS Couplings (-2 and -3) (G51) Section O (See Crimp Data Manual 428-7365 or eCrimp)



Part No.	Description	Product No.	Standard Pack					
71011	2TH7XCTN	4467-1154	250	1/8	.32	3000	12000	.50
85401	3TH7 X50FT	4467-1194	1	3/16	.41	3000	12000	.75
71012	3TH7XCTN	4467-1155	250	3/16	.41	3000	12000	.75
85402	4TH7 X50FT	4467-1195	1	1/4	.50	2750	11000	1.5
71013	4TH7XCTN	4467-1157	250	1/4	.50	2750	11000	1.5
85403	5TH7 X50FT	4467-1160	1	5/16	.56	2500	10000	2.25
71014	5TH7XCTN	4467-1159	250	5/16	.56	2500	10000	2.25
85404	6TH7 X50FT	4467-1162	1	3/8	.64	2250	9000	2.75
71015	6TH7XCTN	4467-1161	250	3/8	.64	2250	9000	2.75
85405	8TH7 X50FT	4467-1164	1	1/2	.80	2000	8000	3.75
71021	8TH7XCTN	4467-1207	250	1/2	.80	2000	8000	3.75
85406	12TH7 X50FT	4467-1193	1	3/4	1.05	1250	5000	5.0



## TH7 HYDRAULIC HOSE - SAE 100R7 - CONTINUED

## THERMOPLASTIC - CONTINUED

Part No.	Description	Product No.	Standard Pack					
71070	12TH7XCTN	4467-1165	200	3/4	1.05	1250	5000	5.0
85407	16TH7 X50FT	4467-1197	1	1	1.32	1000	4000	8.0
71071	16TH7XCTN	4467-1196	200	1	1.32	1000	4000	8.0

## TH7NC NON CONDUCTIVE HYDRAULIC HOSE - SAE 100R7

## THERMOPLASTIC

## RECOMMENDED FOR

Petroleum and synthetic hydraulic fluids. Applications include: power and telephone mobile equipment (cherry pickers), lubrication lines, blowout preventer control lines, hydraulic lifts and farm and construction machinery. Orange color TH7NC meets SAE 100R7 non-conductivity requirements and meets or exceeds performance requirements of SAE 100R7 with a significantly tighter bend radius. Meets ANSI A92.2 for vehicle mounted aerial devices.



## TUBE

-2, -12, and -16: 100% seamless Nylon that easily handles a broad range of hydraulic fluids, including phosphate esters and water glycol; -3 through -8 Polyester. See Hose Stock Characteristics.

## REINFORCEMENT

Synthetic fiber and Nylon (-2 only).

## COVER

Orange Urethane that resists hydraulic fluids, high temperatures, aging and weathering. Orange TH7NC is non-perforated for applications requiring electrical non-conductivity. Meets SAE 100R7 Electrical Conductivity Test. Maximum leakage shall not exceed 50 microamperes when subjected to 75 kV/Ft. for five minutes. (Orange is industry accepted color for non-conductive hose).

## TEMPERATURE RANGE

-65°F to +200°F (-54°C to +93°C) continuous service for petroleum and synthetic oils. Maximum of +158°F (+70°C) for water, water/oil emulsions and water glycol.

## COUPLING RECOMMENDATION

MegaCrimp® Couplings (G25) Section G  
Swage PCTS Couplings (-2 and -3) (G51) Section O  
(See Crimp Data Manual 428-7365 or eCrimp)

Part No.	Description	Product No.	Standard Pack					.50 feet length icon"/>
71072	2TH7NCXCTN	4467-1166	250	1/8	.32	3000	12000	.50
85408	3TH7NC X50FT	4467-1205	1	3/16	.41	3000	12000	.75
71073	3TH7NCXCTN	4467-1167	250	3/16	.41	3000	12000	.80
85409	4TH7NC X50FT	4467-1170	1	1/4	.50	2750	11000	1.5
71016	4TH7NCXCTN	4467-1169	250	1/4	.50	2750	11000	1.5
85410	5TH7NC X50FT	4467-1172	1	5/16	.56	2500	10000	2.25
71074	5TH7NCXCTN	4467-1171	250	5/16	.56	2500	10000	2.25
85411	6TH7NC X50FT	4467-1174	1	3/8	.64	2250	9000	2.75
71017	6TH7NCXCTN	4467-1173	250	3/8	.64	2250	9000	2.75
85412	8TH7NC X50FT	4467-1206	1	1/2	.80	2000	8000	3.75
71018	8TH7NCXCTN	4467-1175	250	1/2	.80	2000	8000	3.75
85413	12TH7NC X50FT	4467-1200	1	3/4	1.05	1250	5000	5.0
71075	12TH7NCXCTN	4467-1177	200	3/4	1.05	1250	5000	5.0
85414	16TH7NC X50FT	4467-1199	1	1	1.32	1000	4000	6.5
71076	16TH7NCXCTN	4467-1198	200	1	1.32	1000	4000	6.5



**TH7DL DUAL LINE HYDRAULIC HOSE - SAE 100R7**

**THERMOPLASTIC**

RECOMMENDED FOR	Petroleum, water-base and synthetic hydraulic fluids. Applications include: power and telephone mobile equipment (cherry pickers), lubrication lines, blowout preventer control lines, hydraulic lifts and farm and construction machinery. TH7DL hose meets or exceeds performance requirements of SAE 100R7 with significantly tighter bend radius.
TUBE	100% seamless Nylon that easily handles a broad range of hydraulic fluids, including phosphate esters and water glycol. See Hose Stock Characteristics.
REINFORCEMENT	Synthetic fiber.
COVER	Black Urethane that resists hydraulic fluids, high temperatures, aging and weathering. Black TH7DL is perforated for use in general hydraulic and pneumatic service.
TEMPERATURE RANGE	-65°F to +200°F (-54°C to +93°C) continuous service for petroleum and synthetic oils. Maximum of +158°F (+70°C) for water, water/oil emulsions and water glycol.
COUPLING RECOMMENDATION	MegaCrimp® Couplings (G25) Section G (See Crimp Data Manual 428-7365 or eCrimp)



Part No.	Description	Product No.	Standard Pack	⊖	⊕	⊖	⊕	⊖
71084	4TH7DLXCTN	4472-0220	250	1/4	.50	2750	11000	1.5
85422	5TH7DL X50FT	4472-0222	1	5/16	.56	2500	10000	2.25
71085	5TH7DLXCTN	4472-0221	250	5/16	.56	2500	10000	2.25
71022	6TH7DLXCTN	4472-0223	250	3/8	.64	2250	9000	2.75
71086	8TH7DLXCTN	4472-0224	250	1/2	.80	2000	8000	3.75

**TH7NCDL NON CONDUCTIVE DUAL LINE HYDRAULIC HOSE - SAE 100R7**

**THERMOPLASTIC**

RECOMMENDED FOR	Petroleum, water-base and synthetic hydraulic fluids. Applications include: power and telephone mobile equipment (cherry pickers), lubrication lines, blowout preventer control lines, hydraulic lifts and farm and construction machinery. Orange color TH7NCDL meets SAE 100R7 non-conductivity requirements and meets or exceeds performance requirements of SAE 100R7 with significantly tighter bend radius. Meets ANSI A92.2 for vehicle mounted aerial devices.
TUBE	Nylon
REINFORCEMENT	Synthetic fiber.
COVER	Orange Urethane that resists hydraulic fluids, high temperatures, aging and weathering. Orange TH7NCDL is non-perforated for applications requiring electrical non-conductivity. Meets SAE 100R7 Electrical Conductivity Test. Maximum leakage shall not exceed 50 microamperes when subjected to 75 kV/Ft. for five minutes. (Orange is industry accepted color for non-conductive hose.)
TEMPERATURE RANGE	-65°F to +200°F (-54°C to +93°C) continuous service for petroleum and synthetic oils. Maximum of +158°F (+70°C) for water, water/oil emulsions and water glycol.
COUPLING RECOMMENDATION	MegaCrimp® Couplings (G25) Section G (See Crimp Data Manual 428-7365 or eCrimp)



Part No.	Description	Product No.	Standard Pack	⊖	⊕	⊖	⊕	⊖
85786	4TH7NCDL X50FT	4472-0226	1	1/4	.50	2750	11000	1.5
71087	4TH7NCDLXCTN	4472-0225	250	1/4	.50	2750	11000	1.5
85424	6TH7NCDL X50FT	4472-0228	1	3/8	.64	2250	9000	2.75

**TH7NCDL NON CONDUCTIVE DUAL LINE HYDRAULIC HOSE - SAE 100R7 - CONTINUED****THERMOPLASTIC - CONTINUED**

Part No.	Description	Product No.	Standard Pack					
71088	6TH7NCDLXCTN	4472-0227	250	3/8	.64	2250	9000	2.75
71089	8TH7NCDLXCTN	4472-0229	250	1/2	.80	2000	8000	3.75

**TH7S HYDRAULIC HOSE - SAE 100R7****THERMOPLASTIC**

<b>RECOMMENDED FOR</b>	Petroleum and synthetic hydraulic fluids. Applications include power and mobile equipment, lifts and construction machinery. TH7S hose meets or exceeds performance requirements of SAE 100R7 with a significantly tighter bend radius.
<b>TUBE</b>	Polyester
<b>REINFORCEMENT</b>	Synthetic fiber.
<b>COVER</b>	Black Urethane that resists hydraulic fluids, high temperatures, aging and weathering. Black TH7S is perforated for use in general hydraulic and pneumatic service.
<b>TEMPERATURE RANGE</b>	-65°F to +200°F (-54°C to +93°C) continuous service for petroleum and synthetic oils.
<b>COUPLING RECOMMENDATION</b>	MegaCrimp® Couplings (G25) Section G (See Crimp Data Manual 428-7365 or eCrimp)



Part No.	Description	Product No.	Standard Pack					
85653	4TH7SX50FT	4467-8653	1	1/4	.50	2750	11999	1.25
71112	4TH7SXCTN	4467-9112	250	1/4	.50	2750	11999	1.25
85654	5TH7SX50FT	4467-8654	1	5/16	.56	2500	10000	1.75
71113	5TH7SXCTN	4467-9113	250	5/16	.56	2500	10000	1.75
85655	6TH7SX50FT	4467-8655	1	3/8	.64	2250	9000	2.0
71114	6TH7SXCTN	4467-9114	250	3/8	.64	2250	9000	2.0
85656	8TH7SX50FT	4467-8656	1	1/2	.80	2000	8000	3.0
71115	8TH7SXCTN	4467-9115	250	1/2	.80	2000	8000	3.0





**TH7SNC NON CONDUCTIVE HYDRAULIC HOSE - SAE 100R7**

**THERMOPLASTIC**

RECOMMENDED FOR	Orange color TH7SNC meets SAE 100R7 non-conductivity requirements and meets or exceeds performance requirements of SAE 100R7 with a significantly tighter bend radius. Meets ANSI A92.2 for vehicle mounted aerial devices.
TUBE	Nylon
REINFORCEMENT	Synthetic fiber.
COVER	Orange Urethane that resists hydraulic fluids, high temperatures, aging and weathering. Orange THS7NC is non-perforated for applications requiring electrical non-conductivity. Meets SAE 100R7 Electrical Conductivity Test. Maximum leakage shall not exceed 50 microamperes when subjected to 75 kV/Ft. for five minutes. (Orange is industry accepted color for non-conductive hose).
TEMPERATURE RANGE	-65°F to +200°F (-54°C to +93°C) continuous service for petroleum and synthetic oils.
COUPLING RECOMMENDATION	MegaCrimp® Couplings (G25) Section G (See Crimp Data Manual 428-7365 or eCrimp)



Part No.	Description	Product No.	Standard Pack					
85668	6TH7SNCX50FT	4467-0017	1	3/8	.64	2250	9000	2.0
85669	8TH7SNCX50FT	4467-0019	1	1/2	.80	2000	8000	3.0

**TH8 HYDRAULIC HOSE - SAE 100R8**

**THERMOPLASTIC**

RECOMMENDED FOR	Use with petroleum, water base and synthetic hydraulic fluids. Applications include: power and telephone mobile equipment (cherry pickers), lubrication lines, blowout preventer control lines, hydraulic lifts and farm and construction machinery. TH8 hose meets or exceeds performance requirements of SAE 100R8 with a significantly tighter bend radius. Multiline available.
TUBE	100% seamless Nylon that easily handles a broad range of hydraulic fluids, including phosphate esters and water glycol. See Hose Stock Characteristics.
REINFORCEMENT	Polyester.
COVER	Black Urethane resists hydraulic fluids, high temperatures, aging and weathering. Black TH8 cover is perforated for use in general hydraulic and pneumatic service.
TEMPERATURE RANGE	-65°F to +200°F (-54°C to +93°C) continuous service for petroleum and synthetic oils. Maximum of +158°F (+70°C) for water, water/oil emulsions and water glycol.
COUPLING RECOMMENDATION	MegaCrimp® Couplings (-4 through -16) (G25) Section G (See Crimp Data Manual 428-7365 or eCrimp)



Part No.	Description	Product No.	Standard Pack					
85415	3TH8 X50FT	4467-1201	1	3/16	.50	5000	20000	1.5
71077	3TH8XCTN	4467-1178	250	3/16	.50	5000	20000	1.5
85416	4TH8 X50FT	4467-1180	1	1/4	.61	5000	20000	2.0
71078	4TH8XCTN	4467-1179	250	1/4	.61	5000	20000	2.0
85417	6TH8 X50FT	4467-1182	1	3/8	.75	4000	16000	2.5
71079	6TH8XCTN	4467-1181	250	3/8	.75	4000	16000	2.5
85418	8TH8 X50FT	4467-1202	1	1/2	.87	3500	14000	4.0
71019	8TH8XCTN	4467-1183	250	1/2	.87	3500	14000	4.0
71080	12TH8XCTN	4467-1184	200	3/4	1.13	2250	9000	6.5
71081	16TH8XCTN	4467-1185	200	1	1.45	2000	8000	10.0

**TH8NC NON CONDUCTIVE HYDRAULIC HOSE - SAE 100R8****THERMOPLASTIC****RECOMMENDED FOR**

Use with petroleum, water base and synthetic hydraulic fluids. Applications include: power and telephone mobile equipment (cherry pickers), lubrication lines, blowout preventer control lines, hydraulic lifts and farm and construction machinery. TH8NC hose (orange cover) meets SAE 100R8 non-conductivity requirements. TH8NC hose meets or exceeds performance requirements of SAE 100R8 with a significantly tighter bend radius. Multiline available.

**TUBE**

100% seamless Nylon that easily handles a broad range of hydraulic fluids, including phosphate esters and water glycol. See Hose Stock Characteristics.

**REINFORCEMENT**

Polyester.

**COVER**

Orange Urethane resists hydraulic fluids, high temperatures, aging and weathering. TH8NC is non-perforated for applications requiring electrical non-conductivity. Meets SAE 100R8 Electrical Conductivity Test. Maximum leakage shall not exceed 50 microamperes when subjected to 75 kV/Ft. for five minutes. (Orange is industry accepted color for non-conductive hose).

**TEMPERATURE RANGE**

-65°F to +200°F (-54°C to +93°C) continuous service for petroleum and synthetic oils. Maximum of +158°F (+70°C) for water, water/oil emulsions and water glycol.

**COUPLING RECOMMENDATION**

MegaCrimp® Couplings (G25) Section G  
(See Crimp Data Manual 428-7365 or eCrimp)

Part No.	Description	Product No.	Standard Pack					
85419	4TH8NC X50FT	4467-1187	1	1/4	.61	5000	20000	2.0
71020	4TH8NCXCTN	4467-1186	250	1/4	.61	5000	20000	2.0
85420	6TH8NC X50FT	4467-1203	1	3/8	.75	4000	16000	2.5
71082	6TH8NCXCTN	4467-1204	250	3/8	.75	4000	16000	2.5
85421	8TH8NC X50FT	4467-1190	1	1/2	.87	3500	14000	4.0
71083	8TH8NCXCTN	4467-1189	250	1/2	.87	3500	14000	4.0

**TH18 CONSTANT PRESSURE HYDRAULIC HOSE - SAE 100R18****THERMOPLASTIC****RECOMMENDED FOR**

TH18 hose meets or exceeds performance requirements of SAE 100R18 with a significantly tighter bend radius. Suitable for petroleum or synthetic-based hydraulic fluids in hydraulic systems. TH18 is ideal for industrial and agricultural applications exposed to low temperatures or cyclic and quick temperature changes. Remains highly flexible in cold weather conditions and is resistant to hydraulic fluids, high temperatures, aging and weathering.

**TUBE**

Polyester elastomer.

**REINFORCEMENT**

Synthetic fiber.

**COVER**

Black Urethane perforated.

**TEMPERATURE RANGE**

-67°F to +212°F (-55°C to +100°C) continuous service for petroleum and synthetic oils. Maximum of +158°F (+70°C) for water-based fluids.

**COUPLING RECOMMENDATION**

MegaCrimp® Couplings (with TuffCoat® plating) (G25) Section G  
(See Crimp Data Manual 428-7365 or eCrimp)

Part No.	Description	Product No.	Standard Pack					
71001	4TH18XCTN	4467-0006	250	1/4	.48	3000	12000	1.4
71002	5TH18XCTN	4467-0007	250	5/16	.56	3000	12000	1.8
71003	6TH18XCTN	4467-0008	250	3/8	.65	3000	12000	1.8
71004	8TH18XCTN	4467-0009	250	1/2	.89	3000	12000	2.8



**TH18 CONSTANT PRESSURE HYDRAULIC HOSE - SAE 100R18 - CONTINUED**

**THERMOPLASTIC - CONTINUED**

Part No.	Description	Product No.	Standard Pack					
71005	10TH18XCTN	4467-0010	250	5/8	1.03	3000	12000	3.9

**TH18NC CONSTANT PRESSURE NON CONDUCTIVE HYDRAULIC HOSE - SAE 100R18**

**THERMOPLASTIC**

**RECOMMENDED FOR** TH18NC hose meets or exceeds performance requirements of SAE 100R18 with a significantly tighter bend radius. Suitable for petroleum or synthetic-based hydraulic fluids in hydraulic systems. TH18NC non-conductive hose are suitable for use in high-voltage applications. Remains highly flexible in cold weather conditions and is resistant to hydraulic fluids, high temperatures, aging and weathering.



<b>TUBE</b>	Polyester elastomer.
<b>REINFORCEMENT</b>	Synthetic fiber.
<b>COVER</b>	Special Urethane, orange (industry-accepted color for non-conductive hose), non-perforated for applications requiring electrical non-conductivity. Meets SAE 100R18 Electrical Conductivity Test. Maximum leakage shall not exceed 50 microamperes when subjected to 75 kV/Ft. for five minutes.
<b>TEMPERATURE RANGE</b>	-67°F to +212°F (-55°C to +100°C) continuous service for petroleum and synthetic oils. Maximum of +158°F (+70°C) for water-based fluids.
<b>COUPLING RECOMMENDATION</b>	MegaCrimp® Couplings (G25) Section G (See Crimp Data Manual 428-7365 or eCrimp)

Part No.	Description	Product No.	Standard Pack					
71006	4TH18NCXCTN	4467-0011	250	1/4	.48	3000	12000	1.4
71007	5TH18NCXCTN	4467-0012	250	5/16	.56	3000	12000	1.8
71008	6TH18NCXCTN	4467-0013	250	3/8	.65	3000	12000	1.8
71009	8TH18NCXCTN	4467-0014	250	1/2	.89	3000	12000	2.8
71010	10TH18NCXCTN	4467-0015	250	5/8	1.03	3000	12000	3.9

**G3H HIGH-TEMP 2-FIBER BRAID HOSE - SAE 100R3****TRANSFER**

**RECOMMENDED FOR** Hydraulic oil lines, anti-freeze solutions or water. Meets or exceeds requirements of SAE 100R3.

**TUBE** Black, synthetic rubber (Nitrile). See Hose Stock Characteristics.

**REINFORCEMENT** Two fiber braids.

**COVER** Black, oil and abrasion resistant, synthetic rubber (Polychloroprene). See Hose Stock Characteristics.

**TEMPERATURE RANGE** For hydraulic oil lines -40°F to +275°F (-40°C to +135°C) constant and +300°F (+149°C) intermittent (up to 10% of operating time). For water emulsions see Temperature Limits Table.

**COUPLING RECOMMENDATION** GLX® Couplings (-8, -12, -16, and -20) (G44) Section N  
MegaCrimp® Couplings (-4, -6, -8 and -10) (G25) Section G  
(See Crimp Data Manual 428-7365 or eCrimp)



Part No.	Description	Product No.	Standard Pack						
85951	4G3H X25FT	3319-4263	1	1/4	.56	1250	5000	3.0	28
70127	4G3HXCTN	3319-0088	455	1/4	.56	1250	5000	3.0	28
85950	5G3H X50FT	3319-4717	1	5/16	.66	1200	4800	3.5	28
70420	5G3HXCTN	3319-4287	330	5/16	.66	1200	4800	3.5	28
85952	6G3H X25FT	3319-4262	1	3/8	.75	1125	4500	4.0	28
70128	6G3HXCTN	3319-0087	350	3/8	.75	1125	4500	4.0	28
85953	8G3H X25FT	3319-4261	1	1/2	.94	1000	4000	5.0	28
70126	8G3HXCTN	3319-0090	225	1/2	.94	1000	4000	5.0	28
70421	10G3HXCTN	3319-4288	200	5/8	1.10	900	3600	5.5	28
85954	12G3H X25FT	3319-4265	1	3/4	1.25	750	3000	6.0	28
70119	12G3HXCTN	3319-0091	160	3/4	1.25	750	3000	6.0	28
85955	16G3H X25FT	3319-4264	1	1	1.50	565	2260	8.0	20
70120	16G3HXCTN	3319-0092	120	1	1.50	565	2260	8.0	20
85956	20G3H X50FT	3319-4718	1	1 1/4	1.75	375	1500	10.0	15
70121	20G3HXCTN	3319-0071	120	1 1/4	1.75	375	1500	10.0	15
85957	24G3H X50FT	3319-4719	1	1 1/2	1.94	300	1200	12.0	10
70422	24G3HXCTN	3319-4289	131	1 1/2	1.94	300	1200	12.0	10

**GTH HIGH-TEMP 1-FIBER BRAID HOSE - SAE 100R6****TRANSFER**

**RECOMMENDED FOR** Hydraulic oil lines, heavy-duty transmission oil cooler lines and glycol anti-freeze solutions. Meets or exceeds requirements of SAE 100R6.

**TUBE** Black, specially compounded, synthetic rubber (Nitrile). See Hose Stock Characteristics.

**REINFORCEMENT** One fiber braid.

**COVER** Black, oil and abrasion resistant, synthetic rubber (Polychloroprene). See Hose Stock Characteristics.

**TEMPERATURE RANGE** For hydraulic oil lines -40°F to +275°F (-40°C to +135°C) constant and +300°F (+149°C) intermittent (up to 10% of operating time). For water emulsions see Temperature Limits Table.

**COUPLING RECOMMENDATION** MegaCrimp® Couplings (G25) Section G  
Power Crimp® Couplings (-3) Section I  
(See Crimp Data Manual 428-7365 or eCrimp)



Part No.	Description	Product No.	Standard Pack						
70106	3GTHXCTN	3319-3301	715	3/16	.44	500	2000	2.0	28



## GTH HIGH-TEMP 1-FIBER BRAID HOSE - SAE 100R6 - CONTINUED

### TRANSFER - CONTINUED

Part No.	Description	Product No.	Standard Pack						
70107	4GTHXCTN	3319-3305	775	1/4	.50	400	1600	2.5	28
86687	5GTH X50FT	3319-0305	1	5/16	.56	400	1600	3.0	28
70105	5GTH XBULK	3319-3309	250	5/16	.56	400	1600	3.0	28
70108	5GTHXCTN	3319-3310	650	5/16	.56	400	1600	3.0	28
86618	8GTH X50FT	3319-3317	1	1/2	.78	400	1600	4.0	18
70110	8GTHXCTN	3319-3320	400	1/2	.78	400	1600	4.0	18
70131	8GTHXREEL	3319-3323	200	1/2	.78	400	1600	4.0	18
86695	10GTH X25FT	3319-4268	1	5/8	.91	350	1400	5.0	15
70111	10GTHXCTN	3319-3325	250	5/8	.91	350	1400	5.0	15
70130	12GTHXCTN	3319-3335	225	3/4	1.06	300	1200	5.5	15
70746	16GTHXCTN	3319-3345	165	1	1.13	250	1000	8.0	10

## GTHX HIGH-TEMP FIBER SPIRAL HOSE - SAE 100R6

### TRANSFER

RECOMMENDED FOR	Hydraulic oil lines, heavy-duty transmission oil cooler lines and glycol anti-freeze solutions. Meets or exceeds requirements of SAE 100R6.
TUBE	Black, specially compounded, synthetic rubber (Nitrile). See Hose Stock Characteristics.
REINFORCEMENT	Spiraled synthetic fiber.
COVER	Black, oil and abrasion resistant, synthetic rubber (Polychloroprene). See Hose Stock Characteristics.
TEMPERATURE RANGE	For hydraulic oil lines -40°F to +275°F (-40°C to +135°C). For water emulsions see Temperature Limits Table.
COUPLING RECOMMENDATION	MegaCrimp® Couplings (G25) Section G (See Crimp Data Manual 428-7365 or eCrimp)



Part No.	Description	Product No.	Standard Pack						
86688	6GTHX X50FT	3289-0005	1	3/8	.63	400	1600	3.0	28
70109	6GTHX XREEL	3289-0002	300	3/8	.63	400	1600	3.0	28

**M500 WIRE BRAID HOSE****TRANSFER**

RECOMMENDED FOR	Pilot lines, grease lines and pressure return lines, 500 psi or less pressure applications.
TUBE	Black, oil resistant, synthetic rubber (Nitrile).
REINFORCEMENT	One braid of high-tensile steel wire.
COVER	Black, oil and abrasion resistant, synthetic rubber, flame resistance (Nitrile and PVC). Also available with unique abrasion resistant MegaTuff® or XtraTuff® covers. See Hose Stock Characteristics.
TEMPERATURE RANGE	-40°F to +212°F (-40°C to +100°C).
COUPLING RECOMMENDATION	GlobalSpiral™ Couplings (-6 through -16) (G20) Section E MegaCrimp® Couplings (G25) Section G (See Crimp Data Manual 428-7365 or eCrimp)



Meets Flame Resistance Acceptance Designation "MSHA 2G".

Part No.	Description	Product No.	Standard Pack	⊖	⊕	⊖	⊕	⊖
85442	4M500 X50FT	4657-4087	1	1/4	.48	500	2000	2.0
70747	4M500XREEL	4657-8027	440	1/4	.48	500	2000	2.0
85443	6M500 X50FT	4657-4088	1	3/8	.63	500	2000	2.5
70748	6M500XREEL	4657-8028	330	3/8	.63	500	2000	2.5
85444	8M500 X50FT	4657-4089	1	1/2	.76	500	2000	3.5
70749	8M500XREEL	4657-8029	220	1/2	.76	500	2000	3.5
85445	10M500 X50FT	4657-4090	1	5/8	.93	500	2000	4.0
70752	10M500XREEL	4657-8030	220	5/8	.93	500	2000	4.0
85446	12M500 X50FT	4657-4091	1	3/4	1.09	500	2000	4.7
70770	12M500XREEL	4657-8031	220	3/4	1.09	500	2000	4.7
85447	16M500 X50FT	4657-4092	1	1	1.40	500	2000	6.0
70974	16M500XREEL	4657-8032	165	1	1.40	500	2000	6.0

**M500 WIRE BRAID HOSE - MEGATUFF® COVER****TRANSFER**

RECOMMENDED FOR	Pilot lines, grease lines and pressure return lines, 500 psi or less pressure applications.
TUBE	Black, oil resistant, synthetic rubber (Nitrile).
REINFORCEMENT	One braid of high-tensile steel wire.
COVER	Black, oil and abrasion resistant MegaTuff® cover. Also available with unique abrasion resistant XtraTuff® or Standard covers. See Hose Stock Characteristics.
TEMPERATURE RANGE	-40°F to +212°F (-40°C to +100°C).
COUPLING RECOMMENDATION	GlobalSpiral™ Couplings (-6 and -8) (G20) Section E MegaCrimp® Couplings (G25) Section G (See Crimp Data Manual 428-7365 or eCrimp)



Meets Flame Resistance Acceptance Designation "MSHA 2G".

Part No.	Description	Product No.	Standard Pack	⊖	⊕	⊖	⊕	⊖
70985	4M500-MTFXREEL	4657-8039	440	1/4	.48	500	2000	2.0
70986	6M500-MTFXREEL	4657-8040	330	3/8	.63	500	2000	2.5
70987	8M500-MTFXREEL	4657-8041	220	1/2	.76	500	2000	3.5





**M500 WIRE BRAID HOSE - XTRATUFF® COVER**

**TRANSFER**

RECOMMENDED FOR	Pilot lines, grease lines and pressure return lines, 500 psi or less pressure applications.
TUBE	Black, oil resistant, synthetic rubber (Nitrile).
REINFORCEMENT	One braid of high-tensile steel wire.
COVER	Black, oil, abrasion and weather resistant, synthetic rubber (XtraTuff® Nitrile). Also available with unique abrasion resistant MegaTuff® or Standard covers. See Hose Stock Characteristics.
TEMPERATURE RANGE	-40°F to +212°F (-40°C to +100°C).
COUPLING RECOMMENDATION	GlobalSpiral™ Couplings (-6 through -16) (G20) Section E MegaCrimp® Couplings (-6 through -16) (G25) Section G (See Crimp Data Manual 428-7365 or eCrimp)



Meets Flame Resistance Acceptance Designation "MSHA 2G".

Part No.	Description	Product No.	Standard Pack	⊖	⊕	⊙	⊙	⊙	⊙
70979	4M500-XTFXREEL	4657-8033	440	1/4	.48	500	2000		2.0
70980	6M500-XTFXREEL	4657-8034	330	3/8	.63	500	2000		2.5
70981	8M500-XTFXREEL	4657-8035	220	1/2	.76	500	2000		3.5
70982	10M500-XTFXREEL	4657-8036	220	5/8	.93	500	2000		4.0
70983	12M500-XTFXREEL	4657-8037	220	3/4	1.09	500	2000		4.7
70984	16M500-XTFXREEL	4657-8038	165	1	1.40	500	2000		6.0

**MULTI MASTER® GMV™ MEGAFLEX® RETURN LINE AND SUCTION HOSE - SAE 100R4**

**RETURN**

RECOMMENDED FOR	Meets or exceeds SAE 100R4. Meets SAE J30R5 and SAE J20R5* (*except tube dimensions). Applications requiring excellent flexibility and maximum resistance to air, water, coolant, petroleum lubricating oils, and refined fuels. Ideal for hydraulic return and suction lines, transferring refined fuels or other petroleum products, and coolant lines.
TUBE	Type C (Nitrile). Black.
REINFORCEMENT	Synthetic, high tensile textile reinforcement with steel wire helix.
COVER	Type A (Polychloroprene). Black, corrugated.
TEMPERATURE RANGE	-40°F to +275°F (-40°C to +135°C). Laboratory tested for normal service. Increased operating temperatures will reduce hose assembly service life. Warning: Do not convey fuels over +120°F (+49°C) and for coolant applications (20R5) max temperature is +212°F (+100°C).
COUPLING RECOMMENDATION	GL Couplings (G43) Section M GlobalSpiral™ Plus Couplings (-24 and -32) (G22) Section E MegaCrimp® Couplings (-12 through -20) (G25) Section G (See Crimp Data Manual 428-7365 or eCrimp)



Meets Flame Resistance Acceptance Designation "MSHA 2G".

Part No.	Description	Product No.	Standard Pack	⊖	⊕	⊙	⊙	⊙	⊙
85746	MULTI MASTER 12GMV MEGAFLEX 3/4X25FT	4688-2373	1	3/4	1.20	350	1400	.8	30
70295	MULTI MASTER 12GMV MEGAFLEX 3/4XCTN	4688-2282	100	3/4	1.20	350	1400	.80	30
85752	MULTI MASTER 16GMV MEGAFLEX 1X25FT	4688-2374	1	1	1.41	300	1200	1.0	30
70296	MULTI MASTER 16GMV MEGAFLEX 1XCTN	4688-2284	100	1	1.41	300	1200	1.0	30
85753	MULTI MASTER 20GMV MEGAFLEX 1 1/4X25FT	4688-2375	1	1 1/4	1.66	250	1000	1.3	30

**MULTI MASTER® GMV™ MEGAFLEX® RETURN LINE AND SUCTION HOSE - SAE 100R4 - CONTINUED****RETURN - CONTINUED**

Part No.	Description	Product No.	Standard Pack						
70298	MULTI MASTER 20GMV MEGAFLEX 1 1/4XCTN	4688-2286	100	1 1/4	1.66	250	1000	1.3	30
85754	MULTI MASTER 24GMV MEGAFLEX 1 1/2X25FT	4688-2376	1	1 1/2	1.90	150	600	1.5	30
70299	MULTI MASTER 24GMV MEGAFLEX 1 1/2XCTN	4688-2288	100	1 1/2	1.90	160	600	1.5	30
85755	MULTI MASTER 32GMV MEGAFLEX 2X25FT	4688-2377	1	2	2.39	150	600	2.0	30
70302	MULTI MASTER 32GMV MEGAFLEX 2XCTN	4688-2290	100	2	2.39	150	600	2.0	30
85756	MULTI MASTER 40GMV MEGAFLEX 2 1/2X25FT	4688-2378	1	2 1/2	2.94	150	600	2.5	30
70306	MULTI MASTER 40GMV MEGAFLEX 2 1/2XCTN	4688-2300	100	2 1/2	2.94	150	600	2.5	30
85757	MULTI MASTER 48GMV MEGAFLEX 3X25FT	4688-2379	1	3	3.44	150	600	3.0	30
70307	MULTI MASTER 48GMV MEGAFLEX 3XCTN	4688-2292	100	3	3.44	150	600	3.0	30
85758	MULTI MASTER 64GMV MEGAFLEX 4X25FT	4688-2380	1	4	4.48	150	600	4.0	30
70317	MULTI MASTER 64GMV MEGAFLEX 4XCTN	4688-2294	100	4	4.48	150	600	4.0	30
70325	MULTI MASTER 96GMV MEGAFLEX 6XCTN	4688-2295	100	6	6.55	150	600	6.0	30

**GMV GLOBAL MEGAVAC® RETURN LINE AND SUCTION HOSE - SAE 100R4****RETURN**

RECOMMENDED FOR	Petroleum and water base hydraulic fluids in suction lines or in low-pressure return lines. Meets or exceeds requirements of SAE 100R4. Uses half the bend radius of SAE 100R4. Meets marine ABS and DNV-GL with use of HeatGuard® high temp sleeve.
TUBE	Black, synthetic rubber is specifically designed for resistance to high temperatures (Nitrile). See Hose Stock Characteristics.
REINFORCEMENT	Double spiral textile (braid for -12, -16 and -20) reinforced with a helical spiral-wire to prevent collapse.
COVER	Black synthetic rubber is oil and abrasion resistant (Polychloroprene). See Hose Stock Characteristics.
TEMPERATURE RANGE	-40°F to +275°F (-40°C to +135°C). For water emulsions see Temperature Limits Table.
COUPLING RECOMMENDATION	GL Couplings (G43) Section M MegaCrimp® Couplings (G25) Section G Use clamp over beaded nipple. (See Crimp Data Manual 428-7365 or eCrimp)



Meets Flame Resistance Acceptance Designation "MSHA 2G".

Part No.	Description	Product No.	Standard Pack						
85577	12GMV X25FT	4504-0961	1	3/4	1.22	350	1400	2.5	25
70184	12GMVXCTN	4504-0123	100	3/4	1.22	350	1400	2.5	25
85578	16GMV X25FT	4504-0962	1	1	1.45	300	1200	3.0	25
70185	16GMVXCTN	4504-0003	100	1	1.45	300	1200	3.0	25
85579	20GMV X25FT	4504-0963	1	1 1/4	1.76	250	1000	4.0	25
70186	20GMVXCTN	4504-0004	100	1 1/4	1.76	250	1000	4.0	25



**RLA 1-FIBER BRAID RETURN LINE AND LOW PRESSURE HOSE**

**RETURN**

**RECOMMENDED FOR** Low-pressure hydraulic oil return lines for general purpose water, glycol antifreeze solutions, conveying diesel fuel, gasoline or air. Meets SAE 30R2 performance requirements of both Type 1 and Type 2 for fuel and B20 constant contact up to +125°F biodiesel fuel transfer applications.

**TUBE** Black, oil resistant, synthetic rubber (Nitrile). See Hose Stock Characteristics.

**REINFORCEMENT** One fiber braid (-3 to -10). Spiral braid (-12 to -16).

**COVER** Black, synthetic rubber. Oil and abrasion resistant (Nitrile and PVC). See Hose Stock Characteristics.

**TEMPERATURE RANGE** -40°F to +212°F (-40°C to +100°C). Air to +160°F (+71°C) only. For water emulsions see Temperature Limits Table.

**COUPLING RECOMMENDATION** GLX® Couplings (-12 and -16) (G44) Section N  
MegaCrimp® Couplings (G25) Section G  
Power Crimp® Couplings (-3) Section I  
(See Crimp Data Manual 428-7365 or eCrimp)

Meets Flame Resistance Acceptance Designation "MSHA 2G".



Part No.	Description	Product No.	Standard Pack	⊖	⊕	⊖	⊕	⊖	⊕
85940	3RLA X25FT	3284-4028	1	3/16	.41	250	1000	3.0	28
70040	3RLAXREEL	3284-0110	550	3/16	.41	250	1000	3.0	28
85941	4RLA X25FT	3284-4029	1	1/4	.50	250	1000	3.0	28
70041	4RLAXREEL	3284-0120	550	1/4	.50	250	1000	3.0	28
85942	5RLA X25FT	3284-4030	1	5/16	.56	250	1000	4.0	28
70042	5RLAXREEL	3284-0130	550	5/16	.56	250	1000	4.0	28
85943	6RLA-30R2X25FT	3284-4031	1	3/8	.66	250	1000	4.0	28
70043	6RLAXREEL	3284-0140	550	3/8	.66	250	1000	4.0	28
85944	8RLA X25FT	3284-4032	1	1/2	.81	200	800	5.0	20
70044	8RLAXREEL	3284-0150	550	1/2	.81	200	800	5.0	20
85945	10RLA X25FT	3284-4033	1	5/8	.94	200	800	6.0	15
70045	10RLAXREEL	3284-0160	550	5/8	.94	200	800	6.0	15
85946	12RLA-30R2X25FT	3284-4088	1	3/4	1.09	200	800	6.0	10
70046	12RLA-30R2XREEL	3284-0170	650	3/4	1.09	200	800	6.0	10
85947	16RLA-30R2X25FT	3284-4181	1	1	1.34	160	640	8.0	10
70047	16RLA-30R2XREEL	3284-0180	400	1	1.34	160	640	8.0	10

**RLC 3-FIBER BRAID RETURN LINE AND LOW PRESSURE HOSE****RETURN**

RECOMMENDED FOR	Petroleum-based hydraulic oils, glycol antifreeze, air or water in low-pressure fluid transfer or hydraulic system return lines. Generally connected to 100R4 stems, beaded nipples, or tube type ports with worm gear clamps.
TUBE	Black, oil resistant, synthetic rubber (Nitrile). See Hose Stock Characteristics.
REINFORCEMENT	Three fiber braids.
COVER	Black, oil and abrasion resistant, synthetic rubber (Nitrile and PVC). See Hose Stock Characteristics.
TEMPERATURE RANGE	For hydraulic oil lines -40°F to +275°F (-40°C to +135°C) constant and +300°F (+149°C) intermittent (up to 10% of operating time); air to +160°F (+71°C) only. For water emulsions see Temperature Limits Table.
COUPLING RECOMMENDATION	Use barbed stem or beaded-tube with clamps only. (See Crimp Data Manual 428-7365 or eCrimp)



Part No.	Description	Product No.	Standard Pack						
70142	16RLCXCTN	3319-0261	50	1	1.62	200	800	9.0	25
70074	20RLCXCTN	3319-0263	50	1 1/4	1.88	200	800	10.0	25
70075	24RLCXCTN	3319-0264	100	1 1/2	2.12	200	800	11.0	25
70143	28RLCXCTN	3319-0265	50	1 3/4	2.38	200	800	12.0	25
70076	32RLCXCTN	3319-0266	60	2	2.56	200	800	13.0	25
70070	36RLCXCTN	3319-0267	50	2 1/4	2.87	150	600	14.0	25
70077	40RLCXCTN	3319-0268	50	2 1/2	3.12	150	600	16.0	25
70078	48RLCXCTN	3319-0270	50	3	3.62	150	600	20.0	25
70081	56RLCXCTN	3319-0272	50	3 1/2	4.12	150	600	24.0	25
70144	72RLC X10FT	3319-0273	10	4 1/2	5.19	100	400	54.0	25

**MEGATECH® LOC 1-FIBER BRAID HIGH-TEMP LOCK-ON HOSE****LOCK-ON**

RECOMMENDED FOR	High-temperature (+300°F) transmission oil cooler lines, pressurized hot oil return lines and turbocharger oil supply lines. Not recommended for gasoline or diesel fuel applications.
TUBE	True-bore black tube specifically compounded for temperature and chemical resistance (CPE).
REINFORCEMENT	One fiber braid.
COVER	Oil and mildew resistant, textile braid, impregnated with synthetic rubber.
TEMPERATURE RANGE	-40°F to +300°F (-40°C to +149°C).
COUPLING RECOMMENDATION	Field Attachable LOC Couplings (G36) Section AC MegaCrimp® Couplings (-16) (G25) Section G (See Crimp Data Manual 428-7365 or eCrimp)



Part No.	Description	Product No.	Standard Pack					
76993	4MEGATECHLOCXREEL	4319-0106	575	1/4	.50	300	1200	3.0
76994	6MEGATECHLOCXREEL	4319-0107	600	3/8	.64	300	1200	3.0
76995	8MEGATECHLOCXREEL	4319-0108	335	1/2	.78	300	1200	5.0
76996	10MEGATECHLOCXREEL	4319-0109	260	5/8	.91	300	1200	6.0
76997	12MEGATECHLOCXREEL	4319-0110	220	3/4	1.08	300	1200	7.0
76998	16MEGATECHLOCXREEL	4319-0111	200	1	1.33	300	1200	7.0



**LOC 1-FIBER BRAID LOCK-ON HOSE**

**LOCK-ON**

**RECOMMENDED FOR** Petroleum-based hydraulic oils, glycol anti-freeze compounds, water, engine lubricating oils and air. Lock-On hose and couplings are NOT recommended for vibration or pressure surge applications, such as permanent piping in residential or commercial buildings. Meets SAE 30R2, SAE 30R6 and SAE 30R7 performance requirements for fuel and B20 biodiesel fuel transfer applications up to +125°F.



**TUBE** Black, oil resistant, synthetic rubber (Nitrile). See Hose Stock Characteristics.

**REINFORCEMENT** One fiber braid.

**COVER** Oil and mildew resistant, textile braid, impregnated with synthetic rubber.

**TEMPERATURE RANGE** -40°F to +250°F (-40°C to +121°C). For air: -40°F to +160°F (-40°C to +71°C). For water emulsions see Temperature Limits Table.

**COUPLING RECOMMENDATION** Field Attachable LOC Couplings (G36) Section AC  
Use clamp over G37 single bead and G38 barbed with clamp.  
(See Crimp Data Manual 428-7365 or eCrimp)

Part No.	Description	Product No.	Standard Pack					
86691	4LOC X50FT	4319-4935	1	1/4	.52	300	1200	3.0
70030	4LOCXREEL	4319-0112	300	1/4	.52	300	1200	3.0
86630	5LOC X50FT	4319-1794	1	5/16	.56	300	1200	3.0
70231	5LOCXREEL	4319-1793	350	5/16	.56	300	1200	3.0
86692	6LOC X50FT	4319-4936	1	3/8	.64	300	1200	3.0
70031	6LOCXREEL	4319-0113	300	3/8	.64	300	1200	3.0
86693	8LOC X50FT	4319-4937	1	1/2	.80	300	1200	5.0
70032	8LOCXREEL	4319-0114	300	1/2	.80	300	1200	5.0
70033	10LOCXREEL	4319-0115	250	5/8	.90	300	1200	6.0
70034	12LOCXREEL	4319-0116	225	3/4	1.00	300	1200	7.0



**LOL PLUS LOCK-ON HOSE**

**LOCK-ON**

RECOMMENDED FOR	Petroleum-based hydraulic oils, water, glycol anti-freeze solutions, engine lubricating oils, and air. Lock-On hose and couplings are NOT recommended for pressure surge applications or critical applications, such as permanent piping in residential or commercial buildings. Do not use for gasoline or diesel fuels, unless approved by Gates H/C Product Application.
TUBE	Black, oil resistant, synthetic rubber highly resistant to oil and heat (Nitrile). See Hose Stock Characteristics.
REINFORCEMENT	One fiber braid.
COVER	Oil and abrasion resistant synthetic rubber (Nitrile and PVC). Available in black Polychloroprene (LOLA), blue (LOLB), green (LOLG), red (LOLR), yellow (LOLY) and gray (LOLC) colors.
TEMPERATURE RANGE	-40°F to +212°F (-40°C to +100°C). Air to +160°F (+71°C) only. For water emulsions see Temperature Limits Table.
COUPLING RECOMMENDATION	Field Attachable LOC Couplings (G36) Section AC GLX® Couplings (-4, -6, -8 and -12) (G44) Section N Use clamp over G37 single bead and G38 barbed with clamp. (See Crimp Data Manual 428-7365 or eCrimp)



Black Cover Only Meets Flame Resistance Acceptance Designation "MSHA 2G".

Part No.	Description	Product No.	Standard Pack						
70650	3LOLAXREEL*	3284-2500	300	3/16	.41	300	1200	3.0	28
70651	3LOLBXREEL*	3284-2510	300	3/16	.41	300	1200	3.0	28
70655	3LOLCXREEL* **	3284-2520	300	3/16	.41	300	1200	3.0	28
70652	3LOLGXREEL* **	3284-2530	300	3/16	.41	300	1200	3.0	28
70653	3LOLRXREEL*	3284-2540	300	3/16	.41	300	1200	3.0	28
70654	3LOLYXREEL* **	3284-2560	300	3/16	.41	300	1200	3.0	28
85961	4LOLA X50FT	3284-2266	1	1/4	.47	300	1200	3.0	28
70657	4LOLAXREEL	3284-2501	475	1/4	.47	300	1200	3.0	28
85967	4LOLB X25FT	3284-2272	1	1/4	.47	300	1200	3.0	28
70658	4LOLBXREEL	3284-2511	475	1/4	.47	300	1200	3.0	28
70662	4LOLCXREEL	3284-2521	475	1/4	.47	300	1200	3.0	28
85972	4LOLG X25FT	3284-2277	1	1/4	.47	300	1200	3.0	28
70659	4LOLGXREEL	3284-2531	475	1/4	.47	300	1200	3.0	28
85976	4LOLR X25FT	3284-2281	1	1/4	.47	300	1200	3.0	28
70660	4LOLRXREEL	3284-2541	475	1/4	.47	300	1200	3.0	28
70661	4LOLYXREEL	3284-2561	475	1/4	.47	300	1200	3.0	28
85960	5LOLA X25FT	3284-2297	1	5/16	.55	300	1200	3.0	28
85962	5LOLA X50FT	3284-2267	1	5/16	.55	300	1200	3.0	28
70664	5LOLAXREEL	3284-2502	300	5/16	.55	300	1200	3.0	28
85963	6LOLA X50FT	3284-2268	1	3/8	.63	300	1200	3.0	28
70665	6LOLAXREEL	3284-2503	300	3/8	.63	300	1200	3.0	28
85968	6LOLB X25FT	3284-2273	1	3/8	.63	300	1200	3.0	28
70666	6LOLBXREEL	3284-2513	300	3/8	.63	300	1200	3.0	28
70670	6LOLCXREEL	3284-2523	300	3/8	.63	300	1200	3.0	28
85973	6LOLG X25FT	3284-2278	1	3/8	.63	300	1200	3.0	28
70667	6LOLGXREEL	3284-2533	300	3/8	.63	300	1200	3.0	28
85977	6LOLR X25FT	3284-2282	1	3/8	.63	300	1200	3.0	28
70668	6LOLRXREEL	3284-2543	300	3/8	.63	300	1200	3.0	28
70669	6LOLYXREEL	3284-2563	300	3/8	.63	300	1200	3.0	28
85964	8LOLA X50FT	3284-2269	1	1/2	.77	300	1200	5.0	28
70672	8LOLAXREEL	3284-2504	300	1/2	.77	300	1200	5.0	28
85969	8LOLB X25FT	3284-2274	1	1/2	.77	300	1200	5.0	28
70673	8LOLBXREEL	3284-2515	300	1/2	.77	300	1200	5.0	28
70677	8LOLCXREEL	3284-2525	300	1/2	.77	300	1200	5.0	28
85974	8LOLG X25FT	3284-2279	1	1/2	.77	300	1200	5.0	28

\*Couplings for this size are available on special order only.  
 \*\*Special hose, subject to minimum order requirements if not in inventory.  
 NOTE: LOL Lock-On Hose is packaged in UPS shippable reels.





**LOL PLUS LOCK-ON HOSE - CONTINUED**

**LOCK-ON - CONTINUED**

Part No.	Description	Product No.	Standard Pack						
70674	8LOLGXREEL	3284-2535	300	1/2	.77	300	1200	5.0	28
85978	8LOLR X25FT	3284-2283	1	1/2	.77	300	1200	5.0	28
70675	8LOLRXREEL	3284-2545	300	1/2	.77	300	1200	5.0	28
70676	8LOLYXREEL	3284-2565	300	1/2	.77	300	1200	5.0	28
85965	10LOLA X50FT	3284-2270	1	5/8	.94	300	1200	6.0	28
70679	10LOLAXREEL	3284-2505	250	5/8	.94	300	1200	6.0	28
85970	10LOLB X25FT	3284-2275	1	5/8	.94	300	1200	6.0	28
70680	10LOLBXREEL	3284-2517	250	5/8	.94	300	1200	6.0	28
70684	10LOLCXREEL	3284-2527	250	5/8	.94	300	1200	6.0	28
70681	10LOLGXREEL*	3284-2537	250	5/8	.94	300	1200	6.0	28
70682	10LOLRXREEL*	3284-2547	250	5/8	.94	300	1200	6.0	28
70683	10LOLYXREEL*	3284-2567	250	5/8	.94	300	1200	6.0	28
85966	12LOLA X50FT	3284-2271	1	3/4	1.06	300	1200	7.0	15
70686	12LOLAXREEL	3284-2506	225	3/4	1.06	300	1200	7.0	15
85971	12LOLB X25FT	3284-2276	1	3/4	1.06	300	1200	7.0	15
70687	12LOLBXREEL	3284-2519	225	3/4	1.06	300	1200	7.0	15
70691	12LOLCXREEL	3284-2529	225	3/4	1.06	300	1200	7.0	15
85975	12LOLG X25FT	3284-2280	1	3/4	1.06	300	1200	7.0	15
70688	12LOLGXREEL	3284-2536	225	3/4	1.06	300	1200	7.0	15
85979	12LOLR X25FT	3284-2284	1	3/4	1.06	300	1200	7.0	15
70689	12LOLRXREEL	3284-2549	225	3/4	1.06	300	1200	7.0	15
70690	12LOLYXREEL	3284-2569	225	3/4	1.06	300	1200	7.0	15

\*Special hose, subject to minimum order requirements if not in inventory.  
 NOTE: LOL Lock-On Hose is packaged in UPS shippable reels.

**AB SERIES AIR BRAKE HOSE**

**FLEET**

**RECOMMENDED FOR** Truck, bus and mobile air brake systems. Can be used as flexible connector between frame and axle. Meets SAE J1402 specifications. Complies with DOT FMVSS 106 requirements.

**TEMPERATURE RANGE** -40°F to +212°F (-40°C to +100°C).

**COUPLING RECOMMENDATION** Gates G33 Series type air brake couplings. Section AC (See Crimp Data Manual 428-7365 or eCrimp)



Part No.	Description	Product No.	Standard Pack				
27240	3/8 X 50FT Rubber Air Brake	3245-0601	1	3/8	3/4	225	1000
28760	3/8 X 250FT Reel Rubber Air Brake	3245-0602	1	3/8	3/4	225	1000
27241	1/2 X 50FT Rubber Air Brake	3245-0603	1	1/2	7/8	225	1000
28761	1/2 X 250FT Reel Rubber Air Brake	3245-0604	1	1/2	7/8	225	1000

NOTE: Federal law requires registration with the Department of Transportation for anyone producing air brake hose assemblies with swaged or crimped fittings. See Engineering and Technical Data Section for compliance.

**HEAVY-DUTY GREEN STRIPE® AIR BRAKE HOSE****FLEET**

**RECOMMENDED FOR** Truck, bus and mobile air brake systems. Can be used as flexible connector between frame and axle. Exceeds SAE J1402 and Bendix specifications. Complies with DOT FMVSS 106 requirements.

**TEMPERATURE RANGE** -40°F to +212°F (-40°C to +100°C).

**COUPLING RECOMMENDATION** Gates G33 Series type air brake couplings. Section AC (See Crimp Data Manual 428-7365 or eCrimp)



Part No.	Description	Product No.	Standard Pack				
28304	3/8 X250 REEL GS RBR AB	3245-4470	1	3/8	3/4	225	1000
27221	1/2" HD GS AIR BRAKE X50FT	3245-4467	1	1/2	7/8	225	1000
27220	6ABGS X50FT	3245-4468	1	3/8	3/4	225	1000

NOTE: Federal law requires registration with the Department of Transportation for anyone producing air brake hose assemblies with swaged or crimped fittings. See Engineering and Technical Data Section for compliance.

**GREEN STRIPE® VACUUM BRAKE HOSE****FLEET**

**RECOMMENDED FOR** Extra heavy-duty hose designed to fit most air brake systems on trucks, trailers and other heavy equipment. Exceeds SAE J1403, Type H requirements. Complies with DOT FMVSS 106VH requirements.

**TEMPERATURE RANGE** -40°F to +257°F (-40°C to +125°C).

**COUPLING RECOMMENDATION** Gates G33 Series type air brake couplings. Section AC (See Crimp Data Manual 428-7365 or eCrimp)



Part No.	Description	Product No.	Standard Pack				
27212	5/8 X50FT VAC BRAKE	3245-4476	1	5/8	1 1/16	800	30
27213	3/4 X50FT VAC BRAKE	3145-4477	1	3/4	1 3/16	800	30



**TR500 HIGH-TEMP/AIR BRAKE/ENGINE HOSE**

**FLEET**

**RECOMMENDED FOR** Air brake hose, high temperature pressurized oil return lines and rotary oil/air compressor lines, engine and transmission coolant lines and lube oil lines. Meets or exceeds DOT FMVSS 106-74, SAE J1402 for air brake hose (-4, -6, -8, -10). Not recommended for gasoline or diesel fuel applications.

**TUBE** Black Nitrile. See Hose Stock Characteristics.

**REINFORCEMENT** One braid of high-tensile steel wire.

**COVER** Oil and mildew resistant, textile braid, impregnated with synthetic rubber.

**TEMPERATURE RANGE** -40°F to +250°F (-40°C to +121°C). For water emulsions see Temperature Limits Table.

**COUPLING RECOMMENDATION** MegaCrimp® Couplings (G25) Section G (See Crimp Data Manual 428-7365 or eCrimp)



Part No.	Description	Product No.	Standard Pack						
85745	4TR500 X50FT	4657-2600	1	1/4	.51	500	2000	1.0	30
70881	4TR500XREEL	4657-2228	250	1/4	.51	500	2000	1.0	30
85747	6TR500 X50FT	4657-2601	1	3/8	.66	500	2000	1.8	30
70883	6TR500XREEL	4657-2520	350	3/8	.66	500	2000	1.8	30
85748	8TR500 X50FT	4657-2602	1	1/2	.80	500	2000	2.3	30
70884	8TR500XREEL	4657-2521	350	1/2	.80	500	2000	2.3	30
85749	10TR500 X50FT	4657-2603	1	5/8	.93	500	2000	2.8	30
70885	10TR500XREEL	4657-2229	300	5/8	.93	500	2000	2.8	30
85750	12TR500 X50FT	4657-2604	1	3/4	1.04	500	2000	3.5	30
70886	12TR500XREEL	4657-2230	200	3/4	1.04	500	2000	3.5	30
85751	16TR500 X50FT	4657-2605	1	1	1.30	500	2000	4.5	30
70887	16TR500XREEL	4657-2231	150	1	1.30	500	2000	4.5	30

NOTE: Federal law requires registration with the Department of Transportation for anyone producing air brake hose assemblies with swaged or crimped fittings. See Engineering and Technical Data Section for compliance.

**MEGATECH® G5TB OIL-AIR RETURN**

**FLEET**

**RECOMMENDED FOR** Pressurized hot oil return lines and rotary oil lines.

**TUBE** True-bore black tube specifically compounded for temperature and chemical resistance (CPE).

**REINFORCEMENT** Two braids of high-tensile steel wire.

**COVER** Blue, oil and mildew resistant textile braid, impregnated with synthetic rubber.

**TEMPERATURE RANGE** Petroleum-base fluids: -40°F to +300°F (-40°C to +149°C). Phosphate esters fluids as recommended by the fluid manufacturer, but within a range of -40°F to +212°F (-40°C to +100°C). For water emulsions see Temperature Limits Table.

**COUPLING RECOMMENDATION** GL Couplings (-24 and -32) (G43) Section M  
GlobalSpiral™ Plus Couplings (-24 and -32) (G22) Section E  
MegaCrimp® Couplings (G25) Section G  
(See Crimp Data Manual 428-7365 or eCrimp)



Part No.	Description	Product No.	Standard Pack						
85391	4MEGATECH G5TB X50FT	4657-4070	1	1/4	.58	3000	12000	2.0	2.0
71023	4MEGATECH G5TBXREEL	4657-2183	400	1/4	.58	3000	12000	2.0	2.0
85392	6MEGATECH G5TB X50FT	4657-4071	1	3/8	.76	3000	12000	2.5	2.5

**MEGATECH® G5TB OIL-AIR RETURN - CONTINUED****FLEET - CONTINUED**

Part No.	Description	Product No.	Standard Pack					
71024	6MEGATECH G5TBXREEL	4657-2184	350	3/8	.76	3000	12000	2.5
85393	8MEGATECH G5TB X50FT	4657-4072	1	1/2	.87	3000	12000	3.5
71025	8MEGATECH G5TBXREEL	4657-2185	350	1/2	.87	3000	12000	3.5
71066	10MEGATECH G5TBXREEL	4657-2186	300	5/8	.98	2000	8000	4.0
71067	12MEGATECH G5TBXREEL	4657-2187	200	3/4	1.12	2000	8000	4.7
85396	16MEGATECH G5TB X50FT	4657-4075	1	1	1.34	1000	4000	6.0
71026	16MEGATECH G5TBXREEL	4657-2188	150	1	1.34	1000	4000	6.0
85398	20MEGATECH G5TB X25FT	4657-4079	1	1 1/4	1.70	1000	4000	8.5
85397	20MEGATECH G5TB X50FT	4657-4076	1	1 1/4	1.70	1000	4000	8.5
71027	20MEGATECH G5TBXCTN	4657-2189	100	1 1/4	1.70	1000	4000	8.5
85395	24MEGATECH G5TB X25FT	4657-4080	1	1 1/2	1.94	500	2000	9.5
85394	24MEGATECH G5TB X50FT	4657-4077	1	1 1/2	1.94	500	2000	9.5
71028	24MEGATECH G5TBXCTN	4657-2190	100	1 1/2	1.94	500	2000	9.5
85400	32MEGATECH G5TB X25FT	4657-4081	1	2	2.53	500	2000	10.5
85399	32MEGATECH G5TB X50FT	4657-4078	1	2	2.53	500	2000	10.5
71029	32MEGATECH G5TBXCTN	4657-2191	100	2	2.53	500	2000	10.5

**MEGATECH® II - SAE 100R2 TYPE AT - ACP****FLEET**

RECOMMENDED FOR	Multi-purpose high-pressure, high-temperature, air compressor lines, petroleum-base or phosphate ester hydraulic fluid supply lines. Meets or exceeds the requirements of SAE 100R2.
TUBE	Black, oil resistant, synthetic rubber (CPE). See Hose Stock Characteristics.
REINFORCEMENT	Two braids of high-tensile steel wire.
COVER	Blue, oil and abrasion resistant, polyester braid.
TEMPERATURE RANGE	-40°F to +300°F (-40°C to +149°C).
COUPLING RECOMMENDATION	GlobalSpiral™ Plus Couplings (-24 and -32) (G22) Section E MegaCrimp® Couplings (-20) (G25) Section G Stainless Steel Braid Couplings (-24 and -32) (G17) Section H (See Crimp Data Manual 428-7365 or eCrimp)



Part No.	Description	Product No.	Standard Pack					
70975	20ACP MEGATECHIIIXCTN	4657-8018	100	1 1/4	1.89	2250	9000	15.0
70858	24ACP MEGATECHIIIXCTN	4657-2484	100	1 1/2	2.13	1500	6000	20.0
70802	32ACP MEGATECHII XCTN50	4657-4734	50	2	2.61	1300	5200	25.0
70859	32ACP MEGATECHIIIXCTN	4657-2485	100	2	2.61	1300	5200	25.0



**MEGATECH® 3000 HIGH-TEMP OIL-AIR RETURN**

**FLEET**

RECOMMENDED FOR	Pressurized hot oil return lines and rotary oil lines.
TUBE	True-bore black tube specifically compounded for temperature and chemical resistance (CPE).
REINFORCEMENT	Two braids of high-tensile steel wire.
COVER	Oil and mildew resistant, textile braid, impregnated with synthetic rubber.
TEMPERATURE RANGE	Petroleum-base fluids: -40°F to +300°F (-40°C to +149°C). Phosphate esters fluids as recommended by the fluid manufacturer, but within a range of -40°F to +212°F (-40°C to +100°C). For water emulsions see Temperature Limits Table.
COUPLING RECOMMENDATION	MegaCrimp® Couplings (G25) Section G (See Crimp Data Manual 428-7365 or eCrimp)



Part No.	Description	Product No.	Standard Pack	⊖	⊕	⊖	⊕	R <sup>2</sup>	⊖
70960	4MEGATECH 3000XREEL	4657-2373	400	1/4	.59	3000	12000	2.0	30
85987	4MEGATECH3000 X50FT	4657-4116	1	1/4	.59	3000	12000	2.0	30
70961	6MEGATECH 3000XREEL	4657-2374	350	3/8	.74	3000	12000	2.5	30
85988	6MEGATECH3000 X50FT	4657-4117	1	3/8	.74	3000	12000	2.5	30
70962	8MEGATECH 3000XREEL	4657-2319	350	1/2	.86	3000	12000	3.5	30
85989	8MEGATECH3000 X50FT	4657-4118	1	1/2	.86	3000	12000	3.5	30

**MEGATECH® 1000 HIGH-TEMP OIL-AIR RETURN**

**FLEET**

RECOMMENDED FOR	Air brake hose, pressurized hot oil return lines and rotary oil/air compressor lines. Meets the requirements of DOT FMVSS 106-74, SAE J1402, for Air Brake Hose (-4, -6, -8, -10). Not recommended for gasoline or diesel fuel applications.
TUBE	Black tube specifically compounded for temperature and chemical resistance (CPE). See Hose Stock Characteristics.
REINFORCEMENT	One braid of high-tensile steel wire.
COVER	Oil and mildew resistant, textile braid, impregnated with synthetic rubber.
TEMPERATURE RANGE	Petroleum-base fluids: -40°F to +300°F (-40°C to +149°C). Phosphate esters fluids as recommended by the fluid manufacturer, but within a range of -40°F to +212°F (-40°C to +100°C). For water emulsions see Temperature Limits Table.
COUPLING RECOMMENDATION	MegaCrimp® Couplings (G25) Section G (See Crimp Data Manual 428-7365 or eCrimp)



Part No.	Description	Product No.	Standard Pack	⊖	⊕	⊖	⊕	R <sup>2</sup>	⊖
70850	4MEGATECH 1000XREEL	4657-2332	350	1/4	.52	1000	4000	2.0	30
85980	4MEGATECH1000 X50FT	4657-2503	1	1/4	.52	1000	4000	2.0	30
70851	6MEGATECH 1000XREEL	4657-2297	350	3/8	.66	1000	4000	2.5	30
85981	6MEGATECH1000 X50FT	4657-2504	1	3/8	.66	1000	4000	2.5	30
70852	8MEGATECH 1000XREEL	4657-2334	350	1/2	.80	1000	4000	3.5	30
85982	8MEGATECH1000 X50FT	4657-2505	1	1/2	.80	1000	4000	3.5	30
70853	10MEGATECH 1000XREEL	4657-2335	300	5/8	.93	1000	4000	4.0	30
85983	10MEGATECH1000 X50FT	4657-2506	1	5/8	.93	1000	4000	4.0	30
70888	12MEGATECH 1000XREEL	4657-2336	200	3/4	1.15	1000	4000	4.7	30

NOTE: Federal law requires registration with the Department of Transportation for anyone producing air brake hose assemblies with swaged or crimped fittings. See Engineering and Technical Data Section for compliance.

**MEGATECH® 1000 HIGH-TEMP OIL-AIR RETURN - CONTINUED****FLEET - CONTINUED**

Part No.	Description	Product No.	Standard Pack						
85984	12MEGATECH1000 X50FT	4657-4040	1	3/4	1.15	1000	4000	4.7	30
70889	16MEGATECH 1000XREEL	4657-2337	150	1	1.37	1000	4000	6.0	30
85985	16MEGATECH1000 X50FT	4657-4041	1	1	1.37	1000	4000	6.0	30
70890	20MEGATECH 1000XCTN	4657-2338	100	1 1/4	1.68	1000	4000	8.5	30
85986	20MEGATECH1000 X50FT	4657-4042	1	1 1/4	1.68	1000	4000	8.5	30

NOTE: Federal law requires registration with the Department of Transportation for anyone producing air brake hose assemblies with swaged or crimped fittings. See Engineering and Technical Data Section for compliance.

**MEGATECH® 500 HIGH-TEMP OIL-AIR RETURN****FLEET**

RECOMMENDED FOR	Air brake hose, pressurized hot oil return lines and rotary oil/air compressor lines. Not recommended for gasoline or diesel fuel applications.
TUBE	Black tube specifically compounded for temperature and chemical resistance (CPE). See Hose Stock Characteristics.
REINFORCEMENT	One braid of high-tensile steel wire.
COVER	Oil and mildew resistant, textile braid, impregnated with synthetic rubber.
TEMPERATURE RANGE	Petroleum-base fluids: -40°F to +300°F (-40°C to +149°C). Phosphate esters fluids as recommended by the fluid manufacturer, but within a range of -40°F to +212°F (-40°C to +100°C). For water emulsions see Temperature Limits Table.
COUPLING RECOMMENDATION	GL Couplings (G43) Section M GlobalSpiral™ Plus Couplings (-24 and -32) (G22) Section E (See Crimp Data Manual 428-7365 or eCrimp)



Part No.	Description	Product No.	Standard Pack						
70854	24MEGATECH 500XCTN	4657-0204	100	1 1/2	1.95	500	2000	15.0	30
85687	24MEGATECH500 X50FT	4657-0061	1	1 1/2	1.95	500	2000	15.0	30
70855	32MEGATECH 500XCTN	4657-0205	100	2	2.48	500	2000	18.0	30
85688	32MEGATECH500 X50FT	4657-0062	1	2	2.48	500	2000	18.0	30
70856	40MEGATECH 500XCTN	4657-0206	100	2 1/2	2.97	500	2000	22.0	30
70857	48MEGATECH 500XCTN	4657-0207	100	3	3.50	500	2000	24.0	30





**MEGATECH® 250 HIGH-TEMP TRANSMISSION OIL COOLER (TOC) HOSE**

**FLEET**

RECOMMENDED FOR	High-temperature (+300°F) transmission oil cooler lines, pressurized hot oil return lines and turbocharger oil supplies.
TUBE	Black tube specifically compounded for temperature and chemical resistance (CPE). See Hose Stock Characteristics.
REINFORCEMENT	One braid of high-tensile steel wire.
COVER	Oil and mildew resistant, textile braid, impregnated with synthetic rubber.
TEMPERATURE RANGE	Petroleum-base fluids: -40°F to +300°F (-40°C to +149°C). Phosphate esters fluids as recommended by the fluid manufacturer, but within a range of -40°F to +212°F (-40°C to +100°C). For water emulsions see Temperature Limits Table.
COUPLING RECOMMENDATION	MegaCrimp® Couplings (G25) Section G (See Crimp Data Manual 428-7365 or eCrimp)



Part No.	Description	Product No.	Standard Pack							
70891	4MEGATECH 250XREEL	4657-2339	250	1/4	.52	250	1000	1.0	30	
85759	4MEGATECH250 X50FT	4657-0083	1	1/4	.52	250	1000	1.0	30	
70892	6MEGATECH 250XREEL	4657-2340	350	3/8	.64	250	1000	1.8	30	
85760	6MEGATECH250 X50FT	4657-0084	1	3/8	.64	250	1000	1.8	30	
70893	8MEGATECH 250XREEL	4657-2341	350	1/2	.78	250	1000	2.5	30	
85761	8MEGATECH250 X50FT	4657-0085	1	1/2	.78	250	1000	2.5	30	
70894	10MEGATECH 250XREEL	4657-2342	300	5/8	.93	250	1000	3.0	30	
85762	10MEGATECH250 X50FT	4657-0086	1	5/8	.93	250	1000	3.0	30	
70895	12MEGATECH 250XREEL	4657-2343	200	3/4	1.06	250	1000	3.5	30	
85763	12MEGATECH250 X50FT	4657-0087	1	3/4	1.06	250	1000	3.5	30	
70896	16MEGATECH 250XREEL	4657-2344	150	1	1.36	250	1000	4.0	30	
85764	16MEGATECH250 X50FT	4657-0088	1	1	1.36	250	1000	4.0	30	
70900	20MEGATECH 250XCTN	4657-2345	120	1 1/4	1.65	250	1000	4.5	30	
85765	20MEGATECH250 X50FT	4657-0089	1	1 1/4	1.65	250	1000	4.5	30	

**C5C HYDRAULIC HOSE - SAE 100R5****FLEET**

**RECOMMENDED FOR** Medium-pressure hydraulic petroleum-based oil lines in impulse applications, lube oil, air and water in applications such as air brakes, power steering (CAUTION: Intended for heavy-duty commercial vehicle use only), turbocharger oil supplies, tilt cab cylinders, transmission coolant and filtration lines. Meets or exceeds requirements of SAE 100R5 for traditional hydraulic applications, DOT FMVSS 106-74 Type All and SAE J1402 Type All for air brake applications (-4 to -12). Not recommended for gasoline or diesel fuel.



**TUBE** Black, oil and heat-resistant synthetic rubber (Polychloroprene -4 and -5), (Nitrile -6 through -40). See Hose Stock Characteristics.





**REINFORCEMENT** One braid of high-tensile carbon steel wire over one braid of polyester.

**COVER** Black, oil and mildew resistant, polyester braid.

**TEMPERATURE RANGE** Under SAE 100R5 (hydraulic) conditions -40°F to +212°F (-40°C to +100°C). All-purpose fleet application (hot lube oil lines) -40°F to +300°F (-40°C to +149°C). Air to +160°F (+71°C) only. Avoid continuous use at maximum temperature concurrent with maximum working pressures. For water emulsions see Temperature Limits Table.

**COUPLING RECOMMENDATION** C5 Field Attachable Couplings (-4 through -32) (G34) Section K  
C5X Field Attachable Couplings (-5, -8, and -12) (G34) Section K  
(See Crimp Data Manual 428-7365 or eCrimp)

DOT FMVSS 106-74 Type All and SAE J1402 Type All for air brake applications (-4 to -12).

Part No.	Description	Product No.	Standard Pack					
86605	4C5C X50FT	3658-1762	1	3/16	.52	3000	12000	3.0
70589	4C5CXREEL	3658-1775	440	3/16	.52	3000	12000	3.0
86606	5C5C X50FT	3658-1763	1	1/4	.58	3000	12000	3.4
70590	5C5CXREEL	3658-1776	385	1/4	.58	3000	12000	3.4
86607	6C5C X50FT	3658-1764	1	5/16	.67	2250	9000	4.0
70591	6C5CXREEL	3658-1777	385	5/16	.67	2250	9000	4.0
86608	8C5C X50FT	3658-1765	1	13/32	.77	2000	8000	4.6
70592	8C5CXREEL	3658-1778	330	13/32	.77	2000	8000	4.6
86609	10C5C X50FT	3658-1766	1	1/2	.92	1750	7000	5.5
70593	10C5CXREEL	3658-1779	275	1/2	.92	1750	7000	5.5
86610	12C5C X50FT	3658-1767	1	5/8	1.08	1500	6000	6.5
70594	12C5CXREEL	3658-1780	220	5/8	1.08	1500	6000	6.5
86616	16C5C X50FT	3658-1768	1	7/8	1.23	800	3200	7.4
70595	16C5CXREEL	3658-1781	165	7/8	1.23	800	3200	7.4
86617	20C5C X25FT	3658-1772	1	1 1/8	1.50	625	2500	9.0
70096	20C5CXCTN	3658-1758	100	1 1/8	1.50	625	2500	9.0
70097	24C5CXCTN	3658-1759	100	1 3/8	1.75	500	2000	10.5
70098	32C5CXCTN	3658-1760	100	1 13/16	2.22	350	1400	13.3
70099	40C5CXCTN	3658-1761	50	2 3/8	2.88	350	1400	24.0

NOTE: Federal law requires registration with the Department of Transportation for anyone producing air brake hose assemblies with swaged or crimped fittings. See Engineering and Technical Data Section for compliance.



**C5C-XH XTREME® HEAT HOSE - SAE 100R5**

**FLEET**

RECOMMENDED FOR	Extremely high-temperature petroleum-based or phosphate ester fluids, turbo charger oil supply and hot lube oil lines.
TUBE	Black, oil and heat-resistant synthetic polymer tube (CPE). See Hose Stock Characteristics.
REINFORCEMENT	Braided, high-tensile wire and textile.
COVER	Blue, oil and mildew resistant polyester/textile braid.
TEMPERATURE RANGE	-40°F to +302°F (-40°C to +150°C).
COUPLING RECOMMENDATION	C5 Field Attachable Couplings (-6, -16 and -20) (G34) Section K C5X Field Attachable Couplings (-5, -8, and -12) (G34) Section K Crimp options are MegaCrimp™, GlobalSpiral™ (depending on size) (See Crimp Data Manual 428-7365 or eCrimp)



DOT FMVSS 106-74 Type All and SAE J1402 Type All for (-4 to -12).

Part No.	Description	Product No.	Standard Pack	⊖	⊕	⊖	⊕	⊕
70095	4C5CXHXREEL	3658-0150	440	3/16	.52	3000	12000	3.4
86992	5C5CXH X50FT	3658-4001	1	1/4	.58	3000	12000	3.4
70992	5C5CXHXREEL	3658-0151	385	1/4	.58	3000	12000	3.4
86993	6C5CXH X50FT	3658-4002	1	5/16	.67	2250	9000	4.0
70993	6C5CXHXREEL	3658-0152	385	5/16	.67	2250	9000	4.0
86994	8C5CXH X50FT	3658-4003	1	13/32	.77	2000	8000	4.6
70994	8C5CXHXREEL	3658-0153	330	13/32	.77	2000	8000	4.6
86995	10C5CXH X50FT	3658-4004	1	1/2	.92	1750	7000	5.5
70995	10C5CXHXREEL	3658-0154	275	1/2	.92	1750	7000	5.5
86996	12C5CXH X50FT	3658-4005	1	5/8	1.08	1500	6000	6.5
70996	12C5CXHXREEL	3658-0155	220	5/8	1.08	1500	6000	6.5
86997	16C5CXH X50FT	3658-4006	1	7/8	1.23	800	3200	7.4
70997	16C5CXHXREEL	3658-0156	165	7/8	1.23	800	3200	7.4
86998	20C5CXH X50FT	3658-4007	1	1 1/8	1.50	625	2500	9.0
70998	20C5CXHXCTN	3658-0157	120	1 1/8	1.50	625	2500	9.0

**C5D HIGH-TEMP MULTI-FLUID HOSE****FLEET**

RECOMMENDED FOR	Petroleum-based or phosphate ester fluids; diesel fuels and filtration lines, transmission coolant lines, hot lube oil lines, power steering (CAUTION: Intended for heavy-duty commercial vehicle use only), gasoline and turbocharger oil supplies. Tilt cab cylinder and air brakes. C5D (-4 to -12) meets or exceeds DOT FMVSS 106-74 Type All, SAE J1402 Type All. Not approved for bio-diesel above B5.
TUBE	Black, oil and heat-resistant, synthetic rubber (CPE). See Hose Stock Characteristics.
REINFORCEMENT	One braid of high-tensile steel wire over one braid of polyester.
COVER	Green for easy identification, oil and mildew resistant, polyester braid impregnated with synthetic rubber.
TEMPERATURE RANGE	-40°F to +300°F (-40°C to +149°C). Air to +250°F (+121°C) only, maximum phosphate esters to +212°F (+100°C). For water emulsions see Temperature Limits Table.
COUPLING RECOMMENDATION	C5 Field Attachable Couplings (G34) Section K C5X Field Attachable Couplings (-5, -8, and -12) (G34) Section K (See Crimp Data Manual 428-7365 or eCrimp)



DOT FMVSS 106-74 Type All, SAE J1402 Type All (-4 to -12).

Part No.	Description	Product No.	Standard Pack					
85680	4C5D X50FT	3658-0001	1	3/16	.52	1500	6000	1.0
70540	4C5DXREEL	3658-0020	440	3/16	.52	1500	6000	1.0
85681	5C5D X50FT	3658-0007	1	1/4	.58	1500	6000	1.5
70541	5C5DXREEL	3658-0027	385	1/4	.58	1500	6000	1.5
85682	6C5D X50FT	3658-0002	1	5/16	.67	1500	6000	1.8
70542	6C5DXREEL	3658-0021	385	5/16	.67	1500	6000	1.8
85683	8C5D X50FT	3658-0003	1	13/32	.77	1250	5000	2.0
70543	8C5DXREEL	3658-0022	330	13/32	.77	1250	5000	2.0
85684	10C5D X50FT	3658-0008	1	1/2	.92	1250	5000	2.0
70544	10C5DXREEL	3658-0028	275	1/2	.92	1250	5000	2.0
85685	12C5D X50FT	3658-0009	1	5/8	1.08	750	3000	2.3
70545	12C5DXREEL	3658-0029	220	5/8	1.08	750	3000	2.3
85686	16C5D X50FT	3658-0010	1	7/8	1.23	400	1600	3.5
70546	16C5DXREEL	3658-0030	165	7/8	1.23	400	1600	3.5

NOTE: Federal law requires registration with the Department of Transportation for anyone producing air brake hose assemblies with swaged or crimped fittings. See Engineering and Technical Data Section for compliance.



**C5M MARINE FUEL LINE HOSE**

**FLEET**

RECOMMENDED FOR	All commercial and recreational vessel fuel line applications. Suitable for marine diesel, gasoline, B100 Bio-Diesel, gasohol fuels and hot oil applications.
TUBE	Nitrile. See Hose Stock Characteristics.
REINFORCEMENT	One wire braid.
COVER	Nitrile and PVC. Blue. See Hose Stock Characteristics.
TEMPERATURE RANGE	-4°F to +212°F (-20°C to +100°C) continuous service.
COUPLING RECOMMENDATION	Brass or Carbon C5 Field Attachable Couplings (G34) Section K C5X Field Attachable Couplings (-5, -8, and -12) (G34) Section K GlobalSpiral™ Couplings (-10 and -12) (G20) Section E MegaCrimp® Couplings (-5, -6, -8 and -16) (G25) Section G (See Crimp Data Manual 428-7365 or eCrimp)



Meets Flame Resistance Acceptance Designation "MSHA 2G".

Part No.	Description	Product No.	Standard Pack	⊖	⊕	⊖	⊕	⊖
70614	5C5MXREEL	3658-1965	385	1/4	.58	500	2000	1.3
86596	6C5M X50FT	3658-4596	1	5/16	.67	500	2000	1.3
70615	6C5MXREEL	3658-1969	385	5/16	.67	500	2000	1.3
86597	8C5M X50FT	3658-4597	1	13/32	.77	500	2000	1.8
70616	8C5MXREEL	3658-1973	330	13/32	.77	500	2000	1.8
86598	10C5M X50FT	3658-4598	1	1/2	.92	500	2000	2.3
70617	10C5MXREEL	3658-1977	275	1/2	.92	500	2000	2.3
86599	12C5M X50FT	3658-4599	1	5/8	1.08	500	2000	2.8
70618	12C5MXREEL	3658-1981	220	5/8	1.08	500	2000	2.8
86600	16C5M X50FT	3658-4600	1	7/8	1.23	500	2000	3.5
70619	16C5MXREEL	3658-1985	165	7/8	1.23	500	2000	3.5

**C5E HIGH-TEMP FLEXLINE HOSE**

**FLEET**

RECOMMENDED FOR	Air brake hose, power steering (CAUTION: Intended for heavy-duty commercial vehicle use only), engine and transmission coolant lines, and hot (+300°F) lube oil lines. Not recommended for gasoline or diesel fuel.
TUBE	Black, oil and heat-resistant, synthetic rubber (Nitrile). See Hose Stock Characteristics.
REINFORCEMENT	One braid of high-tensile steel wire over one braid of polyester.
COVER	Black, oil and heat resistant, textile braid impregnated with synthetic rubber.
TEMPERATURE RANGE	-40°F to +300°F (-40°C to +149°C). Air +250°F (+121°C) maximum only. For water emulsions see Temperature Limits Table.
COUPLING RECOMMENDATION	C5E Field Attachable Couplings (G35) Section K (See Crimp Data Manual 428-7365 or eCrimp)







DOT FMVSS 106 Type A1 and SAE J1402 Type A1 (-4 to -12).

Part No.	Description	Product No.	Standard Pack	⊖	⊕	⊖	⊕	⊖
85690	4C5E X50FT	3658-4990	1	3/16	.49	1500	6000	.80
70530	4C5EXREEL	3658-0210	440	3/16	.49	1500	6000	.80
85691	5C5E X50FT	3658-4991	1	1/4	.55	1500	6000	1.0
70531	5C5EXREEL	3658-0211	385	1/4	.55	1500	6000	1.0

NOTE: Federal law requires registration with the Department of Transportation for anyone producing air brake hose assemblies with swaged or crimped fittings. See Engineering and Technical Data Section for compliance.

**C5E HIGH-TEMP FLEXLINE HOSE - CONTINUED****FLEET - CONTINUED**









Part No.	Description	Product No.	Standard Pack					
85692	6C5E X50FT	3658-4992	1	5/16	.61	1500	6000	1.3
70532	6C5EXREEL	3658-0212	385	5/16	.61	1500	6000	1.3
85693	8C5E X50FT	3658-4993	1	13/32	.73	1250	5000	1.8
70193	8C5EXCTN	3658-0203	475	13/32	.73	1250	5000	1.8
70533	8C5EXREEL	3658-0213	330	13/32	.73	1250	5000	1.8
85694	10C5E X50FT	3658-4994	1	1/2	.83	1250	5000	2.3
70194	10C5EXCTN	3658-0204	330	1/2	.83	1250	5000	2.3
70534	10C5EXREEL	3658-0214	275	1/2	.83	1250	5000	2.3
85695	12C5E X50FT	3658-4995	1	5/8	.95	750	3000	3.0
70195	12C5EXCTN	3658-0205	200	5/8	.95	750	3000	3.0
70535	12C5EXREEL	3658-0215	220	5/8	.95	750	3000	3.0
85696	16C5E X50FT	3658-4996	1	7/8	1.20	400	1600	3.5
70536	16C5EXREEL	3658-0216	165	7/8	1.20	400	1600	3.5
85697	20C5E X25FT	3658-4989	1	1 1/8	1.49	300	1200	4.5
70197	20C5EXCTN	3658-0207	100	1 1/8	1.49	300	1200	4.5

NOTE: Federal law requires registration with the Department of Transportation for anyone producing air brake hose assemblies with swaged or crimped fittings. See Engineering and Technical Data Section for compliance.

**C14 PTFE HOSE - SAE 100R14 TYPE A - NONCONDUCTIVE****FLEET**

RECOMMENDED FOR	Air compressor discharge, hot oil and fluids, hot and greasy environments.
TUBE	Type A-Nonconductive white, smooth bore Polytetrafluoroethylene (PTFE). See Hose Stock Characteristics.
COVER/REINFORCEMENT	One braid of 300 Series stainless steel wire. 304 Stainless.
TEMPERATURE RANGE	Dynamic: -65°F to +400°F (-54°C to +204°C). Static: -65°F to +450°F (-54°C to +232°C).
COUPLING RECOMMENDATION	Brass and Stainless Steel available. C14 Couplings (G40) Section L (See Crimp Data Manual 428-7365 or eCrimp)



Part No.	Description	Product No.	Standard Pack									
85700	4C14 X25FT	7752-0425	1	3/16	.31	1500	6000	2.0	3000	12000	1500	6000
70804	4C14XCTN	7752-0400	400	3/16	.31	1500	6000	2.0	3000	12000	1500	6000
85701	5C14 X25FT	7752-0525	1	1/4	.38	1500	6000	3.0	3000	12000	1500	6000
70805	5C14XCTN	7752-0500	350	1/4	.38	1500	6000	3.0	3000	12000	1500	6000
85702	6C14 X25FT	7752-0625	1	5/16	.45	1500	6000	4.0	2500	10000	1500	6000
70806	6C14XCTN	7752-0600	300	5/16	.45	1500	6000	4.0	2500	10000	1500	6000
85703	8C14 X25FT	7752-0825	1	13/32	.55	1000	4000	5.3	2000	8000	1000	4000
70808	8C14XCTN	7752-0800	250	13/32	.55	1000	4000	5.3	2000	8000	1000	4000
85704	10C14 X25FT	7752-1025	1	1/2	.65	800	3200	6.5	1500	6000	800	3200
70810	10C14XCTN	7752-1000	200	1/2	.65	800	3200	6.5	1500	6000	800	3200
85705	12C14 X25FT	7752-1225	1	5/8	.79	800	3200	7.8	1200	4800	800	2600
70812	12C14XCTN	7752-1200	150	5/8	.79	800	3200	7.8	1200	4800	800	2600
85706	16C14 X25FT	7752-1625	1	7/8	1.03	800	3500	9.0	1000	4000	800	2200

NOTE: Electrostatic Discharge: Many applications involving PTFE hose do not require a conductive tube. But you must review the potential for electrostatic discharge for every application and be aware that static electricity can be hazardous. In those cases where electrostatic discharge can occur, conductive PTFE hose with a conductive tube (Gates C14CT) is recommended. For more information on electrostatic discharge, refer to Technical Data Section.





**C14 PTFE HOSE - SAE 100R14 TYPE A - NONCONDUCTIVE - CONTINUED**

**FLEET - CONTINUED**

Part No.	Description	Product No.	Standard Pack									
				7/8	1.03	800	3500	9.0	72°F (22°C)	72°F (22°C)	450°F (232°C)	450°F (232°C)
70816	16C14XCTN	7752-1600	100						1000	4000	800	2200

NOTE: Electrostatic Discharge: Many applications involving PTFE hose do not require a conductive tube. But you must review the potential for electrostatic discharge for every application and be aware that static electricity can be hazardous. In those cases where electrostatic discharge can occur, conductive PTFE hose with a conductive tube (Gates C14CT) is recommended. For more information on electrostatic discharge, refer to Technical Data Section.

**C14CT PTFE HOSE - SAE 100R14 TYPE B - CONDUCTIVE**

**FLEET**

RECOMMENDED FOR	Air compressor discharge, hot oil and fluids, hot and greasy environments.
TUBE	Type B-Conductive black/white smooth bore Polytetrafluoroethylene (PTFE). See Hose Stock Characteristics.
COVER/REINFORCEMENT	One braid of 300 Series stainless steel wire. 304 Stainless.
TEMPERATURE RANGE	Dynamic: -65°F to +400°F (-54°C to +204°C). Static: -65°F to +450°F (-54°C to +232°C).
COUPLING RECOMMENDATION	Brass and Stainless Steel available. C14 Couplings (G40) Section L (See Crimp Data Manual 428-7365 or eCrimp)



Part No.	Description	Product No.	Standard Pack									
				5/16	.45	1500	6000	4.0	72°F (22°C)	72°F (22°C)	450°F (232°C)	450°F (232°C)
85730	6C14CT X25FT	7752-3625	1						2500	10000	1500	6000
70906	6C14CTXCTN*	7752-3600	300						2500	10000	1500	6000
85731	8C14CT X25FT	7752-3825	1	13/32	.55	1000	4000	5.3	2000	8000	1000	4000
70908	8C14CTXCTN*	7752-3800	250						2000	8000	1000	4000

\*Type B-Conductive Tube.

NOTE: Electrostatic Discharge: Many applications involving PTFE hose do not require a conductive tube. But you must review the potential for electrostatic discharge for every application and be aware that static electricity can be hazardous. In those cases where electrostatic discharge can occur, conductive PTFE hose with a conductive tube (Gates C14CT) is recommended. For more information on electrostatic discharge, refer to Technical Data Section.

**POLARSEAL® HOSE****FLEET**

**RECOMMENDED FOR** Liquid and gaseous R134a and R12 refrigerants in automotive air conditioning and industrial systems; i.e., tractors construction trucks, mobile and stationary refrigeration units. Designed to minimize permeation of R134a refrigerant. Air conditioning refrigerant hose is manufactured in accordance with SAE J3062, while air conditioning hose assemblies must meet SAE J2064.



<b>TUBE</b>	Black, synthetic rubber (Polychloroprene). See Hose Stock Characteristics.
<b>REINFORCEMENT</b>	Two layers of spiral polyester.
<b>COVER</b>	Black synthetic rubber (EPDM). See Hose Stock Characteristics.
<b>TEMPERATURE RANGE</b>	-22°F to +257°F (-30°C to +125°C).
<b>BARRIER</b>	Nylon liner.
<b>COUPLING RECOMMENDATION</b>	PolarSeal® Couplings (ACA) (G45) Section P (See Crimp Data Manual 428-7365 or eCrimp)

PolarSeal® (ACA) full dimension barrier hose. SAE J51, Type A2 Dimensions; SAE J51, Type D Performance; SAE J3062, Type C, Class II Performance.

Part No.	Description	Product No.	Standard Pack						
85664	6AC134A X25FT	3353-0901	1	5/16	.75	500	2000	2.0	24
70624	6AC134AXREEL	3353-0903	340	5/16	.75	500	2000	2.0	24
85665	8AC134A X25FT	3353-0906	1	13/32	.91	500	2000	3.0	24
70625	8AC134AXREEL	3353-0908	235	13/32	.91	500	2000	3.0	24
85666	10AC134A X25FT	3353-0911	1	1/2	1.00	500	2000	4.0	24
70626	10AC134AXREEL	3353-0913	210	1/2	1.00	500	2000	4.0	24
85667	12AC134A X25FT	3353-0916	1	5/8	1.13	500	2000	5.0	24
70627	12AC134AXREEL	3353-0918	175	5/8	1.13	500	2000	5.0	24

**POLARSEAL® II HOSE****FLEET**

**RECOMMENDED FOR** Most refrigerants blends and compressor lubricants in automotive and heavy-duty truck air conditioning systems where significant reduction in permeation and moisture ingress is desired. Low-permeation hose construction is used by more OEMs around the globe than any other refrigerant hose construction. Gates PolarSeal® II (ACC) derives its performance from a proprietary polyamide barrier and exceptional compounding. Compatible with R134a, R12 and the new R1234yf refrigerant. Air conditioning refrigerant hose is manufactured in accordance with SAE J3062, while air conditioning hose assemblies both hose and coupling meet SAE J2064. Change to SAE specification effective as of August 2015.



<b>TUBE</b>	Black, synthetic Elastomeric rubber.
<b>REINFORCEMENT</b>	Single-braid polyester.
<b>COVER</b>	Heat, moisture and ozone resistant black synthetic Elastomeric cover.
<b>TEMPERATURE RANGE</b>	-22°F to +257°F (-30°C to +125°C).
<b>BARRIER</b>	Nylon liner.
<b>COUPLING RECOMMENDATION</b>	PolarSeal® II Couplings (ACB) (G47) Section R PolarSeal® II Couplings (ACC) (G46) Couplings with band clamp. Section Q (See Crimp Data Manual 428-7365 or eCrimp)

PolarSeal® II (ACC) reduced dimension barrier hose. SAE J3062, Type C, Class I Performance.

Part No.	Description	Product No.	Standard Pack						
85384	6ACC-PSII X50FT	3353-5007	1	5/16	.62	350	1400	1.5	



**POLARSEAL® II HOSE - CONTINUED**

**FLEET - CONTINUED**

Part No.	Description	Product No.	Standard Pack					
71090	6ACC-PSIIXREEL	3353-5006	500	5/16	.62	350	1400	1.5
85385	8ACC-PSII X50FT	3353-5009	1	13/32	.74	350	1400	2.0
71091	8ACC-PSIIXREEL	3353-5008	500	13/32	.74	350	1400	2.0
85386	10ACC-PSII X50FT	3353-5011	1	1/2	.83	350	1400	2.5
71092	10ACC-PSIIXREEL	3353-5010	300	1/2	.83	350	1400	2.5
85387	12ACC-PSII X50FT	3353-5013	1	5/8	.96	350	1400	3.0
71093	12ACC-PSIIXREEL	3353-5012	250	5/8	.96	350	1400	3.0

**PS188 POWER STEERING HOSE**

**FLEET**

RECOMMENDED FOR	Power steering pressure lines. Designed to meet requirements of SAE J2050 specifications.
TUBE	Synthetic rubber specially compounded to provide resistance to high temperatures and power steering fluid (CSM). See Hose Stock Characteristics.
REINFORCEMENT	Two high strength nylon braids that resist high temperatures and allow for expansion for system noise dampening.
COVER	Black, synthetic rubber developed specifically to resist under hood environment (CSM).
TEMPERATURE RANGE	-40°F to +300°F (-40°C to +150°C).
COUPLING RECOMMENDATION	Permanent Power Steering Couplings (G50) Section S (See Crimp Data Manual 428-7365 or eCrimp)



Designed to meet requirements of SAE J2050 specifications.

Part No.	Description	Product No.	Standard Pack					
86049	6PS188 X25FT	3317-0107	1	3/8	.71	1500	6000	3.25
86050	6PS188 X50FT	3317-0108	1	3/8	.71	1500	6000	3.25

**J2AT 2-WIRE BRAID JACK HOSE - 10,000 STATIC PRESSURE ONLY****SPECIALTY**

RECOMMENDED FOR	Hydraulic jack applications. Meets Material Handling Institute specification IJ 100 for hydraulic hose and assemblies used with jacking systems. 10,000 Static Pressure Only.
TUBE	Black, oil resistant, synthetic rubber (Nitrile). See Hose Stock Characteristics.
REINFORCEMENT	Two braids of high-tensile steel wire.
COVER	Black, oil and abrasion resistant, synthetic rubber (Nitrile and PVC). Also available with unique abrasion resistant MegaTuff® cover. See Hose Stock Characteristics.
TEMPERATURE RANGE	-40°F to +120°F (-40°C to +49°C).
COUPLING RECOMMENDATION	Use MegaCrimp® Male Pipe Long Nose Couplings on jack end of assembly for engagement. Section G (See Crimp Data Manual 428-7365 or eCrimp)



Meets Flame Resistance Acceptance Designation "MSHA 2G".

Part No.	Description	Product No.	Standard Pack					
85650	4J2AT X50FT	4657-4880	1	1/4	.59	10000	20000	2.0
70800	4J2ATXREEL	4657-1400	350	1/4	.59	10000	20000	2.0
85651	6J2AT X50FT	4657-4881	1	3/8	.74	10000	20000	2.5
70801	6J2ATXREEL	4657-1404	330	3/8	.74	10000	20000	2.5

**J2AT 2-WIRE BRAID JACK HOSE - MEGATUFF® COVER - 10,000 STATIC PRESSURE ONLY****SPECIALTY**

RECOMMENDED FOR	Ultra high abrasive hydraulic jack applications. Meets Material Handling Institute specification IJ 100 for hydraulic hose and assemblies used with jacking systems. 10,000 Static Pressure.
TUBE	Black, oil resistant, synthetic rubber (Nitrile). See Hose Stock Characteristics.
REINFORCEMENT	Two braids of high-tensile steel wire.
COVER	Black, oil and abrasion resistant, synthetic rubber and MegaTuff® cover. Also available in Standard cover. See Hose Stock Characteristics.
TEMPERATURE RANGE	-40°F to +120°F (-40°C to +49°C).
COUPLING RECOMMENDATION	Use MegaCrimp® Male Pipe Long Nose Couplings on jack end of assembly for engagement. Section G (See Crimp Data Manual 428-7365 or eCrimp)



Meets Flame Resistance Acceptance Designation "MSHA 2G". MegaTuff® hose lasts up to 300 times longer than standard hose during hose-to-hose and hose-to-metal abrasion tests per ISO 6945.

Part No.	Description	Product No.	Standard Pack					
70469	4J2AT-MTFXREEL	4657-1188	350	1/4	.59	10000	20000	2.0
70471	6J2AT-MTFXREEL	4657-1189	330	3/8	.74	10000	20000	2.5



**HOT OILER 2-WIRE BRAID HOSE**

**SPECIALTY**

RECOMMENDED FOR	Static pressure, hot oiler applications. Designed specifically to handle the transfer of hot oil at +275°F continuous, +300°F intermittent to clear the paraffin around the casing to help start the flow of oil to the surface.
TUBE	Black, oil resistant, synthetic rubber (Nitrile). See Hose Stock Characteristics.
REINFORCEMENT	Two braids of high-tensile steel wire.
COVER	Black, oil and abrasion resistant, synthetic rubber (CSM). See Hose Stock Characteristics.
TEMPERATURE RANGE	-40°F to +300°F (-40°C to +149°C).
COUPLING RECOMMENDATION	Field Attachable Type T Couplings (G28) Section J GlobalSpiral™ Plus Couplings (G22) Section E (See Crimp Data Manual 428-7365 or eCrimp)



Meets Flame Resistance Acceptance Designation "MSHA 2G".

Part No.	Description	Product No.	Standard Pack					
80040	24HOX75	4657-4674	1	1 1/2	2.15	2300	6900	20.0

**HOT OILER 2-WIRE BRAID HOSE - MEGATUFF® COVER**

**SPECIALTY**

RECOMMENDED FOR	Static pressure, hot oiler applications. Designed specifically to handle the transfer of hot oil at +275°F continuous, +300°F intermittent to clear the paraffin around the casing to help start the flow of oil to the surface.
TUBE	Black, oil resistant, synthetic rubber (Nitrile). See Hose Stock Characteristics.
REINFORCEMENT	Two braids of high-tensile steel wire.
COVER	Black, oil, abrasion and weather resistant MegaTuff® cover. See Hose Stock Characteristics.
TEMPERATURE RANGE	-40°F to +300°F (-40°C to +149°C).
COUPLING RECOMMENDATION	Field Attachable Type T Couplings (G28) Section J GlobalSpiral™ Plus Couplings (G22) Section E (See Crimp Data Manual 428-7365 or eCrimp)



Meets Flame Resistance Acceptance Designation "MSHA 2G".







Part No.	Description	Product No.	Standard Pack					
70015	24HO-MTFXCTN	4657-4463	120	1 1/2	2.15	2300	6900	20.0

**RFS RED FIRE SUPPRESSANT HOSE****SPECIALTY**

RECOMMENDED FOR	Low-pressure powder fire suppressant applications in mining, forestry and firefighting equipment. The red cover is for easy visual identification in these applications. Meets performance requirements of SAE 100R1.
TUBE	Black, oil resistant, synthetic rubber (Nitrile). See Hose Stock Characteristics.
REINFORCEMENT	One braid of high-tensile steel wire.
COVER	Red, oil and abrasion resistant (Nitrile and PVC).
TEMPERATURE RANGE	-40°F to +212°F (-40°C to +100°C). For water emulsions see Temperature Limits Table.
COUPLING RECOMMENDATION	MegaCrimp® Couplings (G25) Section G Power Crimp® Couplings (-3) Section I (See Crimp Data Manual 428-7365 or eCrimp)









Meets Flame Resistance Acceptance Designation "MSHA 2G".

Part No.	Description	Product No.	Standard Pack						
H24100-03F	3RFSXREEL	4657-2145	440	3/16	.45	3000	12000	3.0	
H24100-04F	4RFSXREEL	4657-3314	440	1/4	.53	2750	11000	4.0	
H24100-06F	6RFSXREEL	4657-3313	300	3/8	.68	2250	9000	5.0	
H24100-08F	8RFSXREEL	4657-3315	330	1/2	.80	2000	8000	7.0	
H24100-12F	12RFSXREEL	4657-3316	300	3/4	1.09	1250	5000	9.5	
H24100-16F	16RFSXREEL	4657-2155	165	1	1.41	1000	4000	12.0	

**PLANT MASTER® 150-200****INDUSTRIAL HOSE**

RECOMMENDED FOR	Air and water applications requiring maximum flexibility in any industry, including mining, construction, agriculture, vehicle repair and in-plant operations. Outstanding resistance to heat and ozone. Suitable for light agricultural spraying, such as dilute solutions of herbicides.
TUBE	Type P (EPDM). Black.
REINFORCEMENT	Synthetic, high tensile textile cord.
COVER	Type P (EPDM). All sizes through 1/2" are perforated.
TEMPERATURE RANGE	-40°F to +200°F (-40°C to +93°C) continuous service.
COUPLING RECOMMENDATION	GLX® Couplings (G44) Section N Power Crimp® Couplings Section I (See Crimp Data Manual 428-7365 or eCrimp)









Part No.	Description	Product No.	Standard Pack						
	1/2X UPS RL 200 ADAPTA BLK	3204-1414	250	1/2	.81	200	600	5.0	25.0
	1/2X250FT PLANT MASTER 200 RED UPS SHIPPABLE	3204-1377	250	1/2	.81	200	600	5.0	25.0
	1/2X500FT CL PLANT MASTER 200 BLACK	3204-4413	500	1/2	.81	200	600	5.0	25.0
	1/2X500FT CL PLANT MASTER 200 RED	3204-5328	500	1/2	.81	200	600	5.0	25.0
	1/2X500FT PLANT MASTER 200 BLACK	3204-1413	500	1/2	.81	200	600	5.0	25.0
	1/2X500FT PLANT MASTER 200 RED	3204-1328	500	1/2	.81	200	600	5.0	25.0
	1/4X500FT CL PLANT MASTER 200 BLACK	3204-4402	500	1/4	.50	200	600	3.0	30.0





## PLANT MASTER® 150-200 - CONTINUED

### INDUSTRIAL HOSE - CONTINUED

Part No.	Description	Product No.	Standard Pack						
	1/4X500FT CL PLANT MASTER 200 RED	3204-5301	500	1/4	.50	200	600	3.0	30.0
	1/4X500FT PLANT MASTER 200 BLACK	3204-1401	500	1/4	.50	200	600	3.0	30.0
	1/4X500FT PLANT MASTER 200 RED	3204-1301	500	1/4	.50	200	600	3.0	30.0
	1/4X500FT PLANT MASTER 200 RED UPS SHIPPABLE	3204-1373	500	1/4	.50	200	600	3.0	30.0
	1X UPS RL 200 ADAPTA BLK	3204-1432	125	1	1.40	200	600	8.0	10.0
	1X125FT PLANT MASTER 200 RED UPS SHIPPABLE	3204-1383	125	1	1.40	200	600	8.0	10.0
	1X400FT PLANT MASTER 150 BLACK	3204-1428	400	1	1.40	150	450	8.0	10.0
	1X400FT PLANT MASTER 150 RED	3204-1358	400	1	1.39	150	450	8.0	10.0
	1X400FT PLANT MASTER 200 BLACK	3204-1431	400	1	1.40	200	600	8.0	10.0
	1X400FT PLANT MASTER 200 RED	3204-1361	400	1	1.39	200	600	8.0	10.0
	3/4X200FT PLANT MASTER 200 RED UPS SHIPPABLE	3204-1381	200	3/4	1.11	200	600	6.0	15.0
	3/4X500FT CL PLANT MASTER 200 BLACK	3204-4422	500	3/4	1.11	200	600	6.0	15.0
	3/4X500FT CL PLANT MASTER 200 RED	3204-5346	500	3/4	1.11	200	600	6.0	15.0
	3/4X500FT PLANT MASTER 200 BLACK	3204-1422	500	3/4	1.11	200	600	6.0	15.0
	3/4X500FT PLANT MASTER 200 RED	3204-1346	500	3/4	1.11	200	600	6.0	15.0
	3/8X UPS RL 200 ADAPTA BLK	3204-1408	500	3/8	.66	200	600	3.0	30.0
	3/8X400FT PLANT MASTER 200 RED UPS SHIPPABLE	3204-1375	400	3/8	.66	200	600	3.0	30.0
	3/8X500FT CL PLANT MASTER 200 BLACK	3204-4407	500	3/8	.66	200	600	3.0	30.0
	3/8X500FT CL PLANT MASTER 200 RED	3204-5319	500	3/8	.66	200	600	3.0	30.0
	3/8X500FT PLANT MASTER 200 BLACK	3204-1407	500	3/8	.66	200	600	3.0	30.0
	3/8X500FT PLANT MASTER 200 RED	3204-1319	500	3/8	.66	200	600	3.0	30.0
	5/8X250FT PLANT MASTER 200 RED UPS SHIPPABLE	3204-1379	250	5/8	.97	200	600	6.0	20.0
	5/8X500FT CL PLANT MASTER 200 RED	3204-5337	500	5/8	.97	200	600	6.0	20.0
	5/8X500FT PLANT MASTER 200 BLACK	3204-1419	500	5/8	.97	200	600	6.0	20.0
	5/8X500FT PLANT MASTER 200 RED	3204-1337	500	5/8	.97	200	600	6.0	20.0
	5/16X500FT PLANT MASTER 200 RED	3204-1316	500	5/16	.53	200	600	3.0	30.0



**PLANT MASTER® 250**

**INDUSTRIAL HOSE**

RECOMMENDED FOR	Air and water applications requiring maximum flexibility in any industry, including mining, construction, agriculture, vehicle repair and in-plant operations. Outstanding resistance to heat and ozone. Suitable for light agricultural spraying, such as dilute solutions of herbicides.
TUBE	Type P (EPDM), Black.
REINFORCEMENT	Synthetic, high tensile textile cord.
COVER	Type P (EPDM). All sizes through 1/2" are perforated.
TEMPERATURE RANGE	-40°F to +200°F (-40°C to +93°C) continuous service.
COUPLING RECOMMENDATION	GLX® Couplings (G44) Section N Power Crimp® Couplings Section I (See Crimp Data Manual 428-7365 or eCrimp)



Part No.	Description	Product No.	Standard Pack	⊖	⊕	⊖	⊕	⊖	⊕
	1 1/2X200FT PLANT MASTER 250 BLACK	3204-1437	200	1 1/2	1.98	250	750	12.0	10.0
	1 1/4X200FT PLANT MASTER 250 BLACK	3204-1434	200	1 1/4	1.73	250	750	10.0	10.0
	1/2X500FT CL PLANT MASTER 250 BLACK	3204-4432	500	1/2	.81	250	750	5.0	25.0
	1/2X500FT CL PLANT MASTER 250 RED	3204-5333	500	1/2	.81	250	750	5.0	25.0
	1/2X500FT PLANT MASTER 250 BLACK	3204-1416	500	1/2	.81	250	750	5.0	25.0
	1/2X500FT PLANT MASTER 250 BLUE	3204-1498	500	1/2	.81	250	750	5.0	25.0
	1/2X500FT PLANT MASTER 250 RED	3204-1331	500	1/2	.81	250	750	5.0	25.0
	1/2X500FT PLANT MASTER 250 YELLOW	3204-1528	500	1/2	.81	250	750	5.0	25.0
	1/4X500FT CL PLANT MASTER 250 RED	3204-5304	500	1/4	.50	250	750	3.0	30.0
	1/4X500FT PLANT MASTER 250 RED	3204-1304	500	1/4	.50	250	750	3.0	30.0
	3/4X50FT PLANT MASTER 250 BLACK	3204-5820	200	3/4	1.15	250	750	6.0	20.0
	3/4X50FT PLANT MASTER 250 RED	3204-5420	200	3/4	1.15	250	750	6.0	20.0
	3/4X500FT CL PLANT MASTER 250 BLACK	3204-4433	500	3/4	1.15	250	750	6.0	20.0
	3/4X500FT CL PLANT MASTER 250 RED	3204-5349	500	3/4	1.11	250	750	6.0	20.0
	3/4X500FT PLANT MASTER 250 BLACK	3204-1425	500	3/4	1.15	250	750	6.0	20.0
	3/4X500FT PLANT MASTER 250 BLUE	3204-1500	500	3/4	1.15	250	750	6.0	20.0
	3/4X500FT PLANT MASTER 250 RED	3204-1349	500	3/4	1.11	250	750	6.0	20.0
	3/8X500FT CL PLANT MASTER 250 BLACK	3204-4431	500	3/8	.66	250	750	3.0	30.0
	3/8X500FT CL PLANT MASTER 250 RED	3204-5321	500	3/8	.66	250	750	3.0	30.0
	3/8X500FT PLANT MASTER 250 BLACK	3204-1410	500	3/8	.66	250	750	3.0	30.0
	3/8X500FT PLANT MASTER 250 BLUE	3204-1497	500	3/8	.66	250	750	3.0	30.0
	3/8X500FT PLANT MASTER 250 RED	3204-1322	500	3/8	.66	250	750	3.0	30.0
	5/8X500FT CL PLANT MASTER 250 RED	3204-5341	500	5/8	.97	250	750	6.0	20.0
	5/8X500FT PLANT MASTER 250 RED	3204-1340	500	5/8	.97	250	750	6.0	20.0



**PLANT MASTER® 300**

**INDUSTRIAL HOSE**

RECOMMENDED FOR	Air and water applications requiring maximum flexibility in any industry, including mining, construction, agriculture, vehicle repair and in-plant operations. Outstanding resistance to heat and ozone. Suitable for light agricultural spraying, such as dilute solutions of herbicides.
TUBE	Type P (EPDM), Black.
REINFORCEMENT	Synthetic, high tensile textile cord.
COVER	Type P (EPDM). All sizes through 1/2" are perforated.
TEMPERATURE RANGE	-40°F to +200°F (-40°C to +93°C) continuous service.
COUPLING RECOMMENDATION	GLX® Couplings (G44) Section N Power Crimp® Couplings Section I (See Crimp Data Manual 428-7365 or eCrimp)



Part No.	Description	Product No.	Standard Pack						
	1/2X500FT CL PLANT MASTER 300 RED	3204-5334	500	1/2	.83	300	900	5.0	25.0
	1/2X500FT PLANT MASTER 300 RED	3204-1334	500	1/2	.83	300	900	5.0	25.0
	1/4X500FT CL PLANT MASTER 300 RED	3204-5307	500	1/4	.53	300	900	3.0	30.0
	1/4X500FT PLANT MASTER 300 RED	3204-1307	500	1/4	.53	300	900	3.0	30.0
	1X400FT CL PLANT MASTER 300 RED	3204-0901	400	1	1.47	300	900	8.0	10.0
	1X400FT PLANT MASTER 300 RED	3204-1364	400	1	1.47	300	900	8.0	10.0
	1X500FT PLANT MASTER 300 RED	3204-1650	500	1	1.47	300	900	8.0	10.0
	3/4X500FT PLANT MASTER 300 BLUE	3204-0560	200	3/4	1.15	300	900	6.0	15.0
	3/4X500FT PLANT MASTER 300 GREEN	3204-0506	200	3/4	1.15	300	900	6.0	15.0
	3/4X500FT PLANT MASTER 300 RED	3204-5675	200	3/4	1.15	300	900	6.0	15.0
	3/4X500FT PLANT MASTER 300 YELLOW	3204-0558	200	3/4	1.15	300	900	6.0	15.0
	3/4X500FT CL PLANT MASTER 300 RED	3204-5355	500	3/4	1.15	300	900	6.0	15.0
	3/4X500FT PLANT MASTER 300 BLUE	3204-1505	500	3/4	1.15	300	900	6.0	15.0
	3/4X500FT PLANT MASTER 300 GREEN	3204-1515	500	3/4	1.15	300	900	6.0	15.0
	3/4X500FT PLANT MASTER 300 RED	3204-1355	500	3/4	1.15	300	900	6.0	15.0
	3/4X500FT PLANT MASTER 300 YELLOW	3204-1525	500	3/4	1.15	300	900	6.0	15.0
	3/8X500FT CL PLANT MASTER 300 RED	3204-5326	500	3/8	.67	300	900	3.0	30.0
	3/8X500FT PLANT MASTER 300 RED	3204-1325	500	3/8	.67	300	900	3.0	30.0

**PLANT MASTER® XTREME® 501 AR****INDUSTRIAL HOSE**

**RECOMMENDED FOR** Applications requiring a premium-quality, multi-purpose hose with superior abrasion resistance for air, oil and some chemical applications. Excellent durability for extra-long life in these applications: mining, air drill, construction, poultry plants and other severe service. Good weather and ozone resistance.

**TUBE** Type C (Nitrile). Black.

**REINFORCEMENT** Synthetic, high tensile textile cord.

**COVER** Type C4 (Carboxylated Nitrile). Yellow.

**TEMPERATURE RANGE** -40°F to +212°F (-40°C to +100°C) continuous service.

**COUPLING RECOMMENDATION** GLX® Couplings (G44) Section N  
MegaCrimp® Couplings (G25) Section G  
Power Crimp® Couplings Section I  
(See Crimp Data Manual 428-7365 or eCrimp)



Meets Flame Resistance Acceptance Designation "MSHA 2G".

Part No.	Description	Product No.	Standard Pack							
	1 1/2XRL100FT PLANT MASTER XTREME 501 AR	3202-0029	100	1 1/2	2.09	501	2004	12.0	10.0	
	1 1/4X300FT PLANT MASTER XTREME 501 AR	3202-0027	300	1 1/4	1.78	501	2004	10.0	10.0	
	1/2X500 RL	3202-0311	500	1/2	.89	501	2004	5.0	25.0	
	1/2X500FT PLANT MASTER XTREME 501 AR	3202-0011	500	1/2	.89	501	2004	5.0	25.0	
	1/4X500 RL	3202-0301	500	1/4	.57	501	2004	3.0	30.0	
	1/4X500FT PLANT MASTER XTREME 501 AR	3202-0001	500	1/4	.57	501	2004	3.0	30.0	
	1X400FT PLANT MASTER XTREME 501 AR	3202-0021	400	1	1.51	501	2004	8.0	10.0	
	2XRL 100FT PLANT MASTER XTREME 501 AR	3202-0032	100	2	2.64	501	2004	14.0	10.0	
	3/4X500 RL	3202-0316	500	3/4	1.22	501	2004	6.0	15.0	
	3/4X500FT PLANT MASTER XTREME 501 AR	3202-0016	500	3/4	1.22	501	2004	6.0	15.0	
	3/8X500 RL	3202-0306	500	3/8	.75	501	2004	3.0	25.0	
	3/8X500FT PLANT MASTER XTREME 501 AR	3202-0006	500	3/8	.75	501	2004	3.0	25.0	

**PLANT MASTER® PLUS****INDUSTRIAL HOSE**

**RECOMMENDED FOR** Applications requiring maximum flexibility and good resistance to air, water and heat. For SAE oils intermittent contact only.

**TUBE** Type B1 (Specially compounded elastomer). Black.

**REINFORCEMENT** Synthetic, high tensile textile cord.

**COVER** Type D3 (Specially compounded elastomer). For 2" Black only. Type P (EPDM). Red. All sizes through 1/2" have perforated cover.

**TEMPERATURE RANGE** -40°F to +200°F (-40°C to +93°C) continuous service.

**COUPLING RECOMMENDATION** GLX® Couplings (G44) Section N  
Power Crimp® Couplings Section I  
(See Crimp Data Manual 428-7365 or eCrimp)



Part No.	Description	Product No.	Standard Pack							
	1 1/2X200FT PLANT MASTER PLUS 250	3200-0016	200	1 1/2	1.98	250	750	12.0	10.0	



## PLANT MASTER® PLUS - CONTINUED

### INDUSTRIAL HOSE - CONTINUED

Part No.	Description	Product No.	Standard Pack							
	1 1/4X200FT PLANT MASTER PLUS 250	3200-0015	200	1 1/4	1.73	250	750	10.0		10.0
	1/2X500FT CL PLANT MASTER PLUS 250	3200-0208	500	1/2	.81	250	750	4.0		25.0
	1/2X500FT CL PLANT MASTER PLUS 300	3200-0209	500	1/2	.84	300	900	4.0		25.0
	1/2X500FT PLANT MASTER PLUS 250	3200-0008	500	1/2	.81	250	750	4.0		25.0
	1/2X500FT PLANT MASTER PLUS 300	3200-0009	500	1/2	.84	300	900	4.0		25.0
	1/4X500FT CL PLANT MASTER PLUS 250	3200-0202	500	1/4	.50	250	750	2.0		30.0
	1/4X500FT PLANT MASTER PLUS 250	3200-0002	500	1/4	.50	250	750	2.0		30.0
	1/4X500FT PLANT MASTER PLUS 300	3200-0003	600	1/4	.57	300	900	2.0		30.0
	1X400FT PLANT MASTER PLUS 250	3200-0014	400	1	1.47	250	750	8.0		10.0
	2X100FT PLANT MASTER PLUS 200	3206-3968	100	2	2.56	200	600	16.5		4.0
	2XCTN PLANT MASTER PLUS 200	3200-1279	100	2	2.56	200	600	16.5		4.0
	3/4X500FT CL PLANT MASTER PLUS 250	3200-0212	500	3/4	1.15	250	750	5.0		20.0
	3/4X500FT CL PLANT MASTER PLUS 300	3200-0213	500	3/4	1.15	300	900	5.0		20.0
	3/4X500FT PLANT MASTER PLUS 250	3200-0012	500	3/4	1.15	250	750	5.0		20.0
	3/4X500FT PLANT MASTER PLUS 300	3200-0013	500	3/4	1.15	300	900	5.0		20.0
	3/8X500FT CL PLANT MASTER PLUS 250	3200-0206	500	3/8	.66	250	750	3.0		30.0
	3/8X500FT CL PLANT MASTER PLUS 300	3200-0207	500	3/8	.73	300	900	3.0		30.0
	3/8X500FT PLANT MASTER PLUS 250	3200-0006	500	3/8	.66	250	750	3.0		30.0
	3/8X500FT PLANT MASTER PLUS 300	3200-0007	500	3/8	.73	300	900	3.0		30.0
	5/8X500FT CL PLANT MASTER PLUS 250	3200-0210	500	5/8	.98	250	750	5.0		20.0
	5/8X500FT PLANT MASTER PLUS 300	3200-0011	500	5/8	.98	300	900	5.0		20.0

**PLANT MASTER® XTREME®****INDUSTRIAL HOSE**

**RECOMMENDED FOR** Applications requiring a premium grade spiral hose with excellent flexibility and maximum resistance to air, water, petroleum oils and lubricating oils, (to +212°F). Recommended for gasoline, kerosene and fuel oil transfer only (to +120°F). Excellent weather and ozone resistance.

**TUBE** Type C (Nitrile). Black.

**REINFORCEMENT** Synthetic, high tensile textile cord.

**COVER** Type C2 (Modified Nitrile). Red.

**TEMPERATURE RANGE** -40°F to +212°F (-40°C to +100°C) continuous service.

**COUPLING RECOMMENDATION** GLX® Couplings (G44) Section N  
Power Crimp® Couplings Section I  
(See Crimp Data Manual 428-7365 or eCrimp)



Part No.	Description	Product No.	Standard Pack						
	1 1/2X200FT PLANT MASTER XTREME 250	3205-0055	200	1 1/2	2.00	250	1000	12.0	10.0
	1 1/4X300FT PLANT MASTER XTREME 250	3205-0049	300	1 1/4	1.75	250	1000	10.0	10.0
	1/2X500 RL PREMO FLEX 250	3205-0230	500	1/2	.85	250	1000	4.0	25.0
	1/2X500 RL PREMO FLEX 315	3205-0231	500	1/2	.88	315	1260	4.0	25.0
	1/2X500FT PLANT MASTER XTREME 250	3205-0030	500	1/2	.85	250	1000	4.0	25.0
	1/2X500FT PLANT MASTER XTREME 315	3205-0031	500	1/2	.88	315	1260	4.0	25.0
	1/4X500 RL PREMO FLEX 250	3205-0215	500	1/4	.50	250	1000	2.0	30.0
	1/4X500FT PLANT MASTER XTREME 250	3205-0015	500	1/4	.50	250	1000	2.0	30.0
	1/4X500FT PLANT MASTER XTREME 315	3205-0016	600	1/4	.57	315	1260	2.0	30.0
	1X400FT PLANT MASTER XTREME 250	3205-0046	400	1	1.47	250	1000	8.0	10.0
	3/4X500 RL PREMO FLEX 250	3205-0240	500	3/4	1.15	250	1000	5.0	20.0
	3/4X500 RL PREMO FLEX 315	3205-0241	500	3/4	1.19	315	1260	5.0	20.0
	3/4X500FT PLANT MASTER XTREME 250	3205-0040	500	3/4	1.15	250	1000	5.0	20.0
	3/4X500FT PLANT MASTER XTREME 315	3205-0041	500	3/4	1.19	315	1260	5.0	20.0
	3/8X500 RL PREMO FLEX 250	3205-0225	500	3/8	.66	250	1000	3.0	30.0
	3/8X500 RL PREMO FLEX 315	3205-0226	500	3/8	.73	315	1260	3.0	30.0
	3/8X500FT PLANT MASTER XTREME 250	3205-0025	500	3/8	.66	250	1000	3.0	30.0
	3/8X500FT PLANT MASTER XTREME 315	3205-0026	500	3/8	.73	315	1260	3.0	30.0
	5/8X500 RL PREMO FLEX 250	3205-0235	500	5/8	.98	250	1000	5.0	20.0
	5/8X500 RL PREMO FLEX 315	3205-0236	500	5/8	.98	315	1260	5.0	20.0
	5/8X500FT PLANT MASTER XTREME 315	3205-0036	500	5/8	.98	315	1260	5.0	20.0





**PLANT MASTER® XTREME® 300 AR**

**INDUSTRIAL HOSE**

**RECOMMENDED FOR** Applications requiring a premium grade spiral hose with superior abrasion resistance, excellent flexibility and maximum resistance to air, water, petroleum oils and lubricating oils (to +212°F). Recommended for gasoline, kerosene, and fuel oil transfer only to +120°F. Good weather and ozone resistance.



<b>TUBE</b>	Type C (Nitrile). Black.
<b>REINFORCEMENT</b>	Synthetic, high tensile textile cord.
<b>COVER</b>	Type C4 (Carboxylated Nitrile). Black or Red.
<b>TEMPERATURE RANGE</b>	-40°F to +212°F (-40°C to +100°C) continuous service.

**COUPLING RECOMMENDATION** GLX® Couplings (G44) Section N  
 MegaCrimp® Couplings (G25) Section G  
 (See Crimp Data Manual 428-7365 or eCrimp)

Meets Flame Resistance Acceptance Designation "MSHA 2G".

Part No.	Description	Product No.	Standard Pack						
	1/2X500RL PREMOFLEX AR RED 300	3205-0408	600	1/2	.84	300	1200	4.0	25.0
	1/2XRL PLANT MASTER XTREME 300 AR BLACK	3205-0505	500	1/2	.84	300	1200	4.0	25.0
	1/2XRL PREMO FLEX AR RED 300	3205-0403	500	1/2	.84	300	1200	4.0	25.0
	1/4X500RL PREMOFLEX AR RED 300	3205-0406	600	1/4	.53	300	1200	2.0	30.0
	1/4XRL PLANT MASTER XTREME 300 AR BLACK	3205-0503	500	1/4	.53	300	1200	2.0	30.0
	1/4XRL PREMO FLEX AR RED 300	3205-0401	500	1/4	.53	300	1200	2.0	30.0
	1XRL PLANT MASTER XTREME 300 AR BLACK	3205-0507	400	1	1.50	300	1200	8.0	10.0
	1XRL PREMO FLEX AR RED 300	3205-0405	400	1	1.50	300	1200	8.0	10.0
	3/4X500RL PREMOFLEX AR RED 300	3205-0409	500	3/4	1.19	300	1200	5.0	20.0
	3/4XRL PLANT MASTER XTREME 300 AR BLACK	3205-0506	500	3/4	1.19	300	1200	5.0	20.0
	3/4XRL PREMO FLEX AR RED 300	3205-0404	500	3/4	1.19	300	1200	5.0	20.0
	3/8X500RL PREMOFLEX AR RED 300	3205-0407	500	3/8	.70	300	1200	3.0	30.0
	3/8XRL PLANT MASTER XTREME 300 AR BLACK	3205-0504	500	3/8	9.50	300	1200	3.0	30.0
	3/8XRL PREMO FLEX AR RED 300	3205-0402	500	3/8	.70	300	1200	3.0	30.0

**PLANT MASTER® PLUS LOCK-ON****INDUSTRIAL HOSE**

RECOMMENDED FOR Air, water, oils, antifreeze solutions and applications where Lock-On fittings are used.

TUBE Type C (Nitrile). Black.

REINFORCEMENT Aramid tensile cord.

COVER Type A (Polychloroprene). Black.  
Type C2 (Modified Nitrile). Blue, red, yellow, green or gray.

TEMPERATURE RANGE -20°F to +212°F (-29°C to +100°C) normal service. For air: +160°F (+71°C) only. For water emulsion, see Gates Hydraulic Hose Catalog.

COUPLING RECOMMENDATION GLX® Couplings (G44) Section N  
(See Crimp Data Manual 428-7365 or eCrimp)



Part No.	Description	Product No.	Standard Pack						
	1/2X500FT PLANT MASTER PLUS 300 LOCK-ON BLACK	3222-0185	500	1/2	.81	300	1200	5.0	30.0
	1/2X500FT PLANT MASTER PLUS 300 LOCK-ON BLUE	3222-0145	500	1/2	.81	300	1200	5.0	30.0
	1/2X500FT PLANT MASTER PLUS 300 LOCK-ON GRAY	3222-0285	500	1/2	.81	300	1200	5.0	30.0
	1/2X500FT PLANT MASTER PLUS 300 LOCK-ON GREEN	3222-0235	500	1/2	.81	300	1200	5.0	30.0
	1/2X500FT PLANT MASTER PLUS 300 LOCK-ON RED	3222-0335	500	1/2	.81	300	1200	5.0	30.0
	3/8X500FT PLANT MASTER PLUS 300 LOCK-ON BLACK	3222-0184	500	3/8	.68	300	1200	3.0	30.0
	3/8X500FT PLANT MASTER PLUS 300 LOCK-ON BLUE	3222-0144	500	3/8	.68	300	1200	3.0	30.0
	3/8X500FT PLANT MASTER PLUS 300 LOCK-ON GRAY	3222-0284	500	3/8	.68	300	1200	3.0	30.0
	3/8X500FT PLANT MASTER PLUS 300 LOCK-ON GREEN	3222-0234	500	3/8	.68	300	1200	3.0	30.0
	3/8X500FT PLANT MASTER PLUS 300 LOCK-ON RED	3222-0334	500	3/8	.68	300	1200	3.0	30.0
	3/8X500FT PLANT MASTER PLUS 300 LOCK-ON YELLOW	3222-0084	500	3/8	.68	300	1200	3.0	30.0
	PYTHON1/4BLKXREEL	3222-0183	500	1/4	.54	300	1200	3.0	30.0
	PYTHON1/4BLUXREEL	3222-0143	500	1/4	.54	300	1200	3.0	30.0
	PYTHON1/4GRYXREEL	3222-0283	500	1/4	.54	300	1200	3.0	30.0



**AG MASTER®**

**INDUSTRIAL HOSE**

RECOMMENDED FOR	Designed for agricultural spraying applications, such as dilute solutions of herbicides and fertilizers. Can also be used for air and water applications requiring maximum flexibility in the agriculture industry. Outstanding resistance to heat and ozone.
TUBE	Type P (EPDM), Black.
REINFORCEMENT	Synthetic, high tensile textile cord.
COVER	Type P (EPDM), Black. All sizes through 1/2" are perforated.
TEMPERATURE RANGE	-40°F to +200°F (-40°C to +93°C) continuous service.
COUPLING RECOMMENDATION	GLX® Couplings (G44) Section N (See Crimp Data Manual 428-7365 or eCrimp)



Part No.	Description	Product No.	Standard Pack						
	1 1/2XRL AG MASTER 250	3204-1086	250	1 1/2	1.98	250	12.0		30.0
	1 1/4XRL AG MASTER 250	3204-1085	300	1 1/4	1.73	250	10.0		30.0
	1/2XRL AG MASTER 200	3204-1081	600	1/2	.81	200	5.0		30.0
	1/4XRL AG MASTER 200	3204-1079	600	1/4	.50	200	3.0		30.0
	1XRL AG MASTER 200	3204-1084	400	1	1.40	200	8.0		30.0
	3/4XRL AG MASTER 200	3204-1083	600	3/4	1.15	200	6.0		30.0
	3/8XRL AG MASTER 200	3204-1080	600	3/8	.66	200	3.0		30.0
	5/8XRL AG MASTER 200	3204-1082	600	5/8	.97	200	6.0		30.0

NOTE: Pressure ratings can only be obtained with proper coupling procedures.

**CLEAN MASTER® PRESSURE WASH**

**INDUSTRIAL HOSE**

RECOMMENDED FOR	Hot and cold water high-pressure cleaning equipment where heavy-duty service is required. Specially compounded cover to handle pressure washer environment.
TUBE	Black Nitrile.
REINFORCEMENT	Braided, high-tensile steel wire.
COVER	Nitrile and PVC. Non-marking except for black.
TEMPERATURE RANGE	-40°F to +250°F (-40°C to +121°C). Laboratory tested for normal service. Increased operating temperatures will reduce hose assembly service life.
COUPLING RECOMMENDATION	MegaCrimp® Couplings (G25) Section G Stainless Steel Braid Couplings (G17) Section H (See Crimp Data Manual 428-7365 or eCrimp)



Exceeds EN1829-2 and has significantly tighter bend radius.

Part No.	Description	Product No.	Standard Pack						
71119	1/2XRL 300FT CLEAN MASTER PW3000 BLACK	4657-9375	300	1/2	.80	3000	12000	2.5	30.0
71120	1/2XRL 300FT CLEAN MASTER PW5000 BLACK	4657-9387	300	1/2	.86	5000	15000	2.5	30.0
71116	1/4XRL 300FT CLEAN MASTER PW4000 BLACK	4657-9377	300	1/4	.53	4000	12000	2.5	30.0
70841	1/4XRL 300FT CLEAN MASTER PW6000 BLACK	4657-2410	300	1/4	.59	6000	24000	2.0	30.0
85698	3/8X50FT CLEAN MASTER PW3000 YELLOW	4657-0064	1	3/8	.68	3000	12000	5.0	30.0
85729	3/8X50FT CLEAN MASTER PW4000 BLACK	4657-9424	35	3/8	.68	4000	16000	5.0	30.0

NOTE: Not recommended for Steam Hose. Use bend restrictors to extend service life.

**CLEAN MASTER® PRESSURE WASH - CONTINUED****INDUSTRIAL HOSE - CONTINUED**

Part No.	Description	Product No.	Standard Pack						
85728	3/8X50FT CLEAN MASTER PW4000 BLUE	4657-9469	1	3/8	.74	4000	16000	5.0	30.0
85725	3/8X50FT CLEAN MASTER PW5000 BLACK	4657-2472	1	3/8	.74	5000	20000	5.0	30.0
70845	3/8XRL 300FT CLEAN MASTER PW 2 WB 5000 BLACK	4657-2407	300	3/8	.74	5000	20000	2.5	30.0
70842	3/8XRL 300FT CLEAN MASTER PW3000 BLACK	4657-2402	300	3/8	.68	3000	12000	2.5	30.0
70848	3/8XRL 300FT CLEAN MASTER PW3000 YELLOW	4657-2417	300	3/8	.68	3000	12000	2.5	30.0
71118	3/8XRL 300FT CLEAN MASTER PW4000 BLACK	4657-9379	300	3/8	.68	4000	12000	2.5	30.0
71117	3/8XRL 300FT CLEAN MASTER PW4000 BLUE	4657-9468	300	3/8	.74	4000	12000	3.5	30.0
76393	3/8XRL 300FT CLEAN MASTER PW5000 BLUE	4657-2429	300	3/8	.74	5000	20000	2.5	30.0
85721	4PC6000 X50FT	4657-2468	1	1/4	.74	6000	24000	4.0	30.0
85722	6PC3000 X50FT	4657-2469	1	3/8	.68	3000	12000	2.5	30.0

NOTE: Not recommended for Steam Hose. Use bend restrictors to extend service life.

**CLEAN MASTER® PRESSURE WASH ASSEMBLIES****INDUSTRIAL HOSE**

RECOMMENDED FOR	Standard-duty use on hot and cold water high-pressure cleaning equipment. Extremely flexible, lightweight and easy to handle. Tube specially compounded to handle high-pressure water service. Specially compounded cover to handle pressure washer environment.
TUBE	Black Nitrile.
REINFORCEMENT	Braided, high-tensile steel wire.
COVER	Black. Nitrile and PVC.
TEMPERATURE RANGE	-40°F to +250°F (-40°C to +121°C). Laboratory tested for normal service. Increased operating temperatures will reduce hose assembly service life.



Part No.	Description	Product No.	Standard Pack						
A36040036		3604-0036	5	1/2	.76	3000	3.5	30.0	
A36040071		3604-0071	5	3/8	.63	3000	2.5	30.0	
A36040035	6PW6MP6MPX600BR	3604-0035	25	3/8	.63	3000	2.5	30.0	



**LP350X HOSE**

**INDUSTRIAL HOSE**

**RECOMMENDED FOR** Liquid or gaseous propane, butane or any combination of these two mixtures up to 350 psi rated working pressure. Can be used for natural gas under certain conditions such as: open/outside areas and well ventilated factory buildings (if local building codes permit). Not recommended for residential or office buildings. Contact Denver Product Application (303) 744-5070 for inspection and assembly testing information. Meets UL Standard #21, CAN/CGA-8.1-M86, NFPA 58, Section 8-3, 5.



<b>TUBE</b>	Nitrile. See Hose Stock Characteristics.
<b>REINFORCEMENT</b>	Braided, high-tensile synthetic textile cord.
<b>COVER</b>	Black perforated Polychloroprene. See Hose Stock Characteristics.
<b>TEMPERATURE RANGE</b>	-40°F to +180°F (-40°C to +82°C). For water emulsions see Temperature Limits Table.

**COUPLING RECOMMENDATION** GLX® Couplings (G44) Section N  
Power Crimp® Couplings (-12) Section I  
(See Crimp Data Manual 428-7365 or eCrimp)

Application Note: No LP350 hose assemblies 60" or longer allowed per UL requirement.

Part No.	Description	Product No.	Standard Pack	⊖	⊕	⊙	⊙	⊙	⊙
85717	4LP350X X50FT	3220-1300	1	1/4	.58	350	1750	3.0	
85718	6LP350X X50FT	3220-1123	1	3/8	.70	350	1750	3.0	
85719	8LP350X X50FT	3220-1301	1	1/2	.91	350	1750	5.0	
85738	12LP350X X50FT	3220-1302	1	3/4	1.24	350	1750	6.0	

**LP350 HOSE**

**INDUSTRIAL HOSE**

**RECOMMENDED FOR** Liquid or gaseous propane, butane or any combination of these two mixtures. Can be used for natural gas (not to exceed 50 psi) under certain conditions such as: open/outside areas and well ventilated factory buildings (if local building codes permit).



<b>TUBE</b>	Type A (Chloroprene). Black. 1 1/2" - 3". Type C (Nitrile). Black. 1/4" - 1 1/4".
<b>REINFORCEMENT</b>	Braided, synthetic high tensile cord. 1 1/4" - 3". High tensile synthetic textile cord. 1/4" - 1".
<b>COVER</b>	Type A (Polychloroprene). Black. All sizes are perforated.
<b>TEMPERATURE RANGE</b>	-40°F to +180°F (-40°C to +82°C) continuous service. Warning: Do not convey LP Gas over +140°F (60°C).

**COUPLING RECOMMENDATION** GLX® Couplings (1/4" to 1 1/4") (G44) Section N  
Power Crimp® Couplings (3/4", 1 1/2" and 2" I.D.) Section I  
(See Crimp Data Manual 428-7365 or eCrimp)

Part No.	Description	Product No.	Standard Pack	⊖	⊕	⊙	⊙	⊙	⊙
	1 1/2X60FT FUEL MASTER LP350	3320-0935	60	1 1/2	2.25	350	1750	12.0	10.0
	1 1/4XRL FUEL MASTER LP350	3220-0855	300	1 1/4	1.85	350	1750	10.0	10.0
	1/2XBULK FUEL MASTER LP350	3220-1205	1000	1/2	.91	350	1750	5.0	25.0
	1/2XRL FUEL MASTER LP350	3220-1204	700	1/2	.91	350	1750	5.0	25.0
	1/4XRL FUEL MASTER LP350	3220-1200	700	1/4	.58	350	1750	3.0	30.0

NOTE: Not recommended for residential, office buildings or as fuel line hose on compressed natural gas vehicles. Contact Denver Product Application (303) 744-5070 for inspection and assembly testing information.



**LP350 HOSE - CONTINUED**

**INDUSTRIAL HOSE - CONTINUED**

Part No.	Description	Product No.	Standard Pack						
	1X100FT FUEL MASTER LP350	3220-1211	100	1	1.51	350	1750	8.0	15.0
	1X125FT FUEL MASTER LP350	3220-1212	125	1	1.51	350	1750	8.0	15.0
	1X150FT FUEL MASTER LP350	3220-1213	150	1	1.51	350	1750	8.0	15.0
	1XRL FUEL MASTER LP350	3220-1210	300	1	1.51	350	1750	8.0	15.0
	2X60FT FUEL MASTER LP350	3320-0938	60	2	2.86	350	1750	14.0	10.0
	3/4X100FT FUEL MASTER LP350	3220-1207	100	3/4	1.23	350	1750	6.0	20.0
	3/4X125FT FUEL MASTER LP350	3220-1208	125	3/4	1.23	350	1750	6.0	20.0
	3/4X150FT FUEL MASTER LP350	3220-1209	150	3/4	1.23	350	1750	6.0	20.0
	3/4XRL FUEL MASTER LP350	3220-1206	350	3/4	1.23	350	1750	6.0	20.0
	3/8XRL FUEL MASTER LP350	3220-1202	700	3/8	.74	350	1750	3.0	30.0
	3X60FT FUEL MASTER LP350	3320-0934	60	3	3.88	350	1750	24.0	10.0

NOTE: Not recommended for residential, office buildings or as fuel line hose on compressed natural gas vehicles. Contact Denver Product Application (303) 744-5070 for inspection and assembly testing information.

**FUEL MASTER® DELIVERY**

**INDUSTRIAL HOSE**

**RECOMMENDED FOR** Transferring fuel oils, diesel fuel or commercial gasolines in applications at temperatures as low as -40°F (-40°C). Compatible with Bio-Diesel fuels up to B20. Hose remains flexible to -20°F (-29°C). For home and heavy-duty commercial service where an abrasion-resistant and non-marking cover is required.



<b>TUBE</b>	Type C (Nitrile). Black.
<b>REINFORCEMENT</b>	High tensile synthetic textile cord.
<b>COVER</b>	Type C4 (Carboxylated Nitrile). Red. Abrasion-resistant and non-marking.
<b>TEMPERATURE RANGE</b>	-40°F to +180°F (-29°C to +82°C) continuous service.

Meets Flame Resistance Acceptance Designation "MSHA 2G".

Part No.	Description	Product No.	Standard Pack						
	1 3/8 X 100 FUEL OIL DEL	3221-0418	100	1 3/8	1.87	200	800	10.0	10.0
	1 3/8 X 125 FUEL OIL DEL	3221-0419	125	1 3/8	1.87	200	800	10.0	10.0
	1 1/2X100 FUEL OIL DEL	3221-0422	100	1 1/2	2.08	200	800	12.0	10.0
	1 1/2X125 FUEL OIL DEL	3221-0423	125	1 1/2	2.08	200	800	12.0	10.0
	1 1/2X150 FUEL OIL DEL	3221-0424	150	1 1/2	2.08	200	800	12.0	10.0
	1 1/2X175 FUEL OIL DEL	3221-0425	175	1 1/2	2.08	200	800	12.0	10.0
	1 1/2X200 FUEL OIL DEL	3221-0426	200	1 1/2	2.08	200	800	12.0	10.0
	1 1/4X100 FUEL OIL DEL	3221-0414	100	1 1/4	1.75	200	800	10.0	10.0
	1 1/4X125 FUEL OIL DEL	3221-0415	125	1 1/4	1.75	200	800	10.0	10.0
	1 1/4X150 FUEL OIL DEL	3221-0416	150	1 1/4	1.75	200	800	10.0	10.0
	1 1/4X175 FUEL OIL DEL	3221-0417	175	1 1/4	1.75	200	800	10.0	10.0
	1 3/8X150FT FUEL MASTER DELIVERY 200	3221-0420	150	1 3/8	1.87	200	800	10.0	10.0





## FUEL MASTER® DELIVERY - CONTINUED

### INDUSTRIAL HOSE - CONTINUED

Part No.	Description	Product No.	Standard Pack						
	1 3/8X175 FUEL OIL DEL	3221-0421	175	1 3/8	1.87	200	800	10.0	10.0
	1X100FT FUEL MASTER DELIVERY 200	3221-0410	100	1	1.50	200	800	8.0	10.0
	1X125FT FUEL MASTER DELIVERY 200	3221-0411	125	1	1.50	200	800	8.0	10.0
	1X150FT FUEL MASTER DELIVERY 200	3221-0412	150	1	1.50	200	800	8.0	10.0
	1X175FT FUEL MASTER DELIVERY 200	3221-0413	175	1	1.50	200	800	8.0	10.0

## LPG VAPOR

### INDUSTRIAL HOSE

**RECOMMENDED FOR** Flexible connector for conveying low-pressure LPG (vapor only) to many types of farm and industrial heating applications; e.g., space heaters.

**TUBE** Type C (Nitrile). Black.

**REINFORCEMENT** High tensile synthetic textile cord.

**COVER** Type A (Polychloroprene). Black.

**TEMPERATURE RANGE** -30°F to +150°F (-34°C to +66°C) continuous service.



Part No.	Description	Product No.	Standard Pack						
	1/4XRL FUEL MASTER LPG VAPOR 125	3220-0456	700	1/4	.53	125	625	3.0	30.0
	3/8XRL FUEL MASTER LPG VAPOR 125	3220-0461	700	3/8	.66	125	625	3.0	25.0
	3/16XRL FUEL MASTER LPG VAPOR 125	3220-0451	700	3/16	.44	125	625	2.0	30.0

NOTE: This hose should not be used for liquid LPG or in UL approved appliances such as barbecue grills.

## FUEL MASTER® CURB PUMP

### INDUSTRIAL HOSE

**RECOMMENDED FOR** Dispensing all types of commercial gasolines or other petroleum-based products, from service station pumps (curb pump). A heavy-duty hardwall hose which does not collapse in reel use or behind the nozzle in heavy-duty service.

**TUBE** Type C (Nitrile). Black.

**REINFORCEMENT** Braided, high-tensile steel wire.

**COVER** Type J (CPE). Black. 5/8" and 3/4" smooth, 1" wrapped.

**TEMPERATURE RANGE** -40°F to +120°F (-40°C to +49°C) continuous service.



Part No.	Description	Product No.	Standard Pack						
	1XRL FUEL MASTER CURB PUMP 150	3624-0003	500	1	1.38	150	750	8.0	30.0
	3/4XRL FUEL MASTER CURB PUMP 150	3624-0002	500	3/4	1.13	150	750	6.0	30.0



**FUEL MASTER® CURB PUMP - CONTINUED**

**INDUSTRIAL HOSE - CONTINUED**

Part No.	Description	Product No.	Standard Pack						
	5/8XRL FUEL MASTER CURB PUMP 150	3624-0001	500	5/8	1.00	150	750	6.0	30.0

**FUEL MASTER® DIESEL CURB PUMP**

**INDUSTRIAL HOSE**

RECOMMENDED FOR	Dispensing of all types of petroleum diesel fuels and Bio-Diesel blends from service station pumps. A heavy-duty hardwall hose which does not collapse in reel use or behind the nozzle in heavy-duty service.
TUBE	Type C (Nitrile). Black.
REINFORCEMENT	Braided, high-tensile steel wire.
COVER	Type J (CPE). Green. Smooth cover.
TEMPERATURE RANGE	-40°F to +120°F (-40°C to +49°C) continuous service.



Part No.	Description	Product No.	Standard Pack						
	1XRL FUEL MASTER DIESEL CURB PUMP 150	3624-1009	500	1	1.38	150	750	8.0	30.0
	7/8XRL FUEL MASTER DIESEL CURB PUMP 150	3624-1008	500	7/8	1.22	150	750	7.0	30.0



**NOTES**



# IN THE SHOP OR IN THE FIELD, GATES HAS A CRIMPER FOR EVERY JOB.

## GC® 16XD™ MINI CRIMPER



- 1" two-wire and 3/4" four-wire capability.
- User-friendly horizontal loading for crimping in the field.
- 80 ton crimp force.
- Unmatched portability and speed with 10,000 psi battery-operated pump.

## MOBILECRIMP® 4-20



- Portable and lightweight – only 78 pounds.
- Powerful enough to crimp up to 1-1/4" I.D. four spiral-wire hose.
- Great for jobs in the field.
- Multiple pump options for maximum flexibility.

## GC® 32TSi™ CRIMPER



- Touch screen simplifies hose and coupling selection.
- Precision crimps without looking up data or adjusting crimper settings.
- After crimp is complete, the crimp O.D. is automatically measured and displayed on screen.
- Controller is updated where wireless internet is available, or via thumb drive.
- All the necessary tools and information reside on-board to crimp, leak-free, factory-quality hydraulic hose assemblies.

## POWER CRIMP® 707



- The most precise, yet simplest crimper made.
- The first crimper with electronic digital readout to indicate crimp diameter setting.
- Crimps low pressure return lines to high pressure spiral hose, from 3/16" to 1-1/4" I.D. four-spiral wire.
- Crimps straight and bent tube couplings plus 45° and 90°. Block style terminations require notched cone.
- Swage capable.

## GC® 96TSi™-3 CRIMPER



- Electronic touch screen control panel for fast input of crimper settings.
- Horizontal front-end feed makes crimping easier and convenient.
- 550 ton force that allows crimping of a wide variety of couplings.
- 2 speed die closure and rapid retract permit fast assembly fabrication.
- Full range die sets that enable production of a wide range of hose assemblies.
- 3" six-wire and 6" industrial.

## SC-32™ CRIMPER



- Compact design to minimize space required.
- High-ton ram force with an integrated pump.
- Pump pre-wired for either 110V or 220V (1 phase) outlets.
- Bottom-loading makes crimping easier.
- Come with all the base plates and spacers required to crimp up to 2" hose.

**For complete crimper specifications, see the following pages.**

EQUIPMENT
HOSE/CPLG. SELECTION
G8K COUPLINGS
GLOBALSPIRAL COUPLINGS
STAINLESS STEEL SPIRAL
MEGACRIMP COUPLINGS
STAINLESS STEEL BRAID
POWER CRIMP COUPLINGS
FIELD ATTACHABLE G1 & G2 COUPLINGS
FIELD ATTACHABLE C5 COUPLINGS
C14 COUPLINGS
GL COUPLINGS
GLX COUPLINGS
PCTS THERMOPLASTIC COUPLINGS
POLARSEAL COUPLINGS (ACA)
POLARSEAL II COUPLINGS (ACC)
POLARSEAL II COUPLINGS (ACB)
POWER STEERING
ADAPTERS
QUICK DISCONNECT COUPLERS
BALL VALVES
LIVE SWIVEL
ASSEMBLY FABRICATION
ACCESSORIES
EQUIPMENT AND PARTS
KITS
AIR BRAKE HOSE ASSY
BRASS



EQUIPMENT
HOSE/CPLG. SELECTION
G8K COUPLINGS
GLOBALSPIRAL COUPLINGS
STAINLESS STEEL SPIRAL
MEGACRIMP COUPLINGS
STAINLESS STEEL BRAID
POWER CRIMP COUPLINGS
FIELD ATTACHABLE G1 & G2 COUPLINGS
FIELD ATTACHABLE C5 COUPLINGS
C14 COUPLINGS
GL COUPLINGS
GLX COUPLINGS
PCTS THERMOPLASTIC COUPLINGS
POLARSEAL COUPLINGS (ACA)
POLARSEAL II COUPLINGS (ACC)
POLARSEAL II COUPLINGS (ACB)
POWER STEERING
ADAPTERS
QUICK DISCONNECT COUPLERS
BALL VALVES
LIVE SWIVEL
ASSEMBLY FABRICATION
ACCESSORIES
EQUIPMENT AND PARTS
KITS
AIR BRAKE HOSE ASSY
BRASS

## GC® 16XD™ MINI CRIMPER

Crimping at remote job sites requires a durable yet user-friendly crimper. Weighing only 44 pounds, this crimper can be used anywhere. The Gates Mini Crimper and pump combine the performance and speed of a powered pump with the convenience of a hand pump.

### Features:

- 1" two-wire and 3/4" 4-wire capability.
- User-friendly horizontal loading for crimping in the field
- 80 ton crimp force
- Unmatched portability and speed with 10,000 psi battery-operated pump

### SPECIFICATIONS

**Part Number:** 70115

**Product Number:** 7480-7006

### Start-up Kit (Ordered Separately)

**Part Number:** 78733

**Product Number:** 7482-7313

- 1 - Digital Caliper 6" (#78241, 7369-0322)
- 1 - Hose Assembly (#78467, 7482-1017)
- 1 - G95311-0606 6MQFFVH-6FP, quick disconnect
- 1 - G95321-0606 6FQFFVH-6FP, quick disconnect
- 2 - GC16XD Mini Crimper Crimp Data Card (#428-3467, 81000)



### QC Tool (Ordered Separately)

**Part Number:** 78759

**Product Number:** 7482-7304

## GC® 16XD™ Die Selection Table

### For MegaCrimp® (G25) Couplings

Hose Type	Hose Sizes					
	1/4"	3/8"	1/2"	5/8"	3/4"	1"
M3K	GC16-21	GC16-22	GC16-33	GC16-34	GC16-35	GC16-37
M2T	GC16-21	GC16-22	GC16-33	GC16-34	GC16-35	GC16-37
G1	GC16-21	GC16-22	GC16-33	GC16-34	GC16-35	GC16-37
G2	GC16-21	GC16-22	GC16-33	GC16-34	GC16-35	GC16-37

For other hose and coupling configurations, reference [www.gates.com/ecrimp](http://www.gates.com/ecrimp)

### For GlobalSpiral™ (G20) Couplings

Hose Type	Hose Sizes			
	3/8"	1/2"	5/8"	3/4"
EFG6K	GC16-33	GC16-33	GC16-35L	GC16-35L
EFG5K	GC16-33	GC16-33	GC16-35L	GC16-35L
EFG4K	GC16-33	GC16-33	GC16-35L	GC16-35L

### Die Sets (ordered separately)

Die Set	GC16-21	GC16-22	GC16-33	GC16-34	GC16-35	GC16-35L	GC16-37
Part No.	78242	78243	78244	78245	78246	78078	78247
Product No.	7482-7321	7482-7322	7482-7333	7482-7334	7482-7335	7482-7310	7482-7337

## Battery Pump

Need to crimp in tight or awkward spaces? Gates new battery-operated pump has a sealed bladder reservoir that prevents contamination and allows the pump to operate in any position. Combined with Gates new GC® 16XD™ Mini Crimper, you can make factory quality assemblies quickly and easily in the most demanding locations.



### Features:

- Cordless, lightweight design with integrated handle and carrying strap
- 1/2 horsepower motor and two 28V Lithium-Ion Milwaukee M28 batteries
- High-strength fiberglass reinforced composite pump shroud for superior durability
- Pump can also be used to operate Gates MC4-20 Crimper

### SPECIFICATIONS

**Part Number:** 70187

**Product Number:** 7481-0011



# MOBILECRIMP® 4-20 CRIMPER

This lightweight, versatile crimper is powerful enough to crimp up to 1-1/4" four spiral-wire hose. Weighing approximately 57 pounds, this field crimper combines crimping technology with toughness and durability.

## DIGITAL DIAL CONTROL

Just dial in appropriate crimp setting and hold the start button until light comes on and buzzer sounds, then release. Ability to lock-in setting for multiple assemblies. Light and buzzer operate on two "AAA" batteries.

**Part Number:** 77421

**Product Number:** 7480-0051

## POSITIVE STOP CONTROL

No settings necessary since color-coded spacer rings control the crimp. Just hold the start button until the ram extends to a fixed "Stop" for each crimp, then release. Controlled crimp stroke for ease of repeatability.

**Part Number:** 77420

**Product Number:** 7480-0050



Accessories	Part Number	Product Number
Crimper-to-Pump Male Quick Disconnect	G95311-0606	7252-88315
Crimper-to-Pump Female Quick Disconnect	G95321-0606	7252-88305

## MobileCrimp® 4-20 Die Selection Table

### For MegaCrimp® (G25) Couplings

Hose Type	Hose Sizes						
	1/4"	3/8"	1/2"	5/8"	3/4"	1"	1-1/4"
M3K MC21 or MC31	MC22 or MC32	MC33	MC34	MC35	MC37	—	
M2T MC21 or MC31	MC22 or MC32	MC33	MC34	MC35	MC37	MC38†	
G1 MC21 or MC31	MC22 or MC32	MC33	MC34	MC35	MC37	MC39	
G2 MC21 or MC31	MC22 or MC32	MC33	MC34	MC35	MC37	MC39	

For other hose and coupling configurations, reference [www.gates.com/ecrimp](http://www.gates.com/ecrimp) or Gates crimp data manual.

† Must use 20M2T pressure plate 78046 / 7482-1078

### For GlobalSpiral™ (G20) Couplings

Hose Type	Hose Sizes					
	3/8"	1/2"	5/8"	3/4"	1"	1-1/4"
EFG6K MC33	MC33	MC35	MC35	MC37	—	
EFG5K MC33	MC33	MC35	MC35	MC37	—	
EFG4K MC33	MC33	MC35	MC35	MC37	MC39*	

\*MGS (G21 series) couplings only.

Die Sets (ordered separately)									
Die Set	MC21/MC31	MC22/MC32	MC33	MC34	MC35	MC36	MC37	MC38	MC39
Part No.	78558/78468	78559/78469	78470	78471	78472	78473	78474	78475	78476
Product No.	7482-1220/1131	7482-1221/1132	7482-1133	7482-1134	7482-1135	7482-1136	7482-1137	7482-1138	7482-1139

EQUIPMENT
HOSE/CPLG. SELECTION
G8K COUPLINGS
GLOBALSPIRAL COUPLINGS
STAINLESS STEEL SPIRAL
MEGACRIMP COUPLINGS
STAINLESS STEEL BRAID
POWER CRIMP COUPLINGS
FIELD ATTACHABLE G1 & G2 COUPLINGS
FIELD ATTACHABLE C5 COUPLINGS
C14 COUPLINGS
GL COUPLINGS
GLX COUPLINGS
PCTS THERMOPLASTIC COUPLINGS
POLARSEAL COUPLINGS (ACA)
POLARSEAL II COUPLINGS (ACC)
POLARSEAL II COUPLINGS (ACB)
POWER STEERING
ADAPTERS
QUICK DISCONNECT COUPLERS
BALL VALVES
LIVE SWIVEL
ASSEMBLY FABRICATION
ACCESSORIES
EQUIPMENT AND PARTS
KITS
AIR BRAKE HOSE ASSY
BRASS



# MOBILECRIMP® 4-20 and GC® 16XD™ POWER SOURCES

Wide selection of pumps to match all your power needs.

EQUIPMENT
HOSE/CPLG. SELECTION
G8K COUPLINGS
GLOBALSPIRAL COUPLINGS
STAINLESS STEEL SPIRAL
MEGACRIMP COUPLINGS
STAINLESS STEEL BRAID
POWER CRIMP COUPLINGS
FIELD ATTACHABLE G1 & G2 COUPLINGS
FIELD ATTACHABLE C5 COUPLINGS
C14 COUPLINGS
GL COUPLINGS
GLX COUPLINGS
PCTS THERMOPLASTIC COUPLINGS
POLARSEAL COUPLINGS (ACA)
POLARSEAL II COUPLINGS (ACC)
POLARSEAL II COUPLINGS (ACB)
POWER STEERING
ADAPTERS
QUICK DISCONNECT COUPLERS
BALL VALVES
LIVE SWIVEL
ASSEMBLY FABRICATION
ACCESSORIES
EQUIPMENT AND PARTS
KITS
AIR BRAKE HOSE ASSY
BRASS



## ◀ HAND PUMP

No power source needed. Economical, convenient and portable for use anywhere. Make factory-quality assemblies in the field to minimize downtime.

**Part Number:** 77821  
**Product Number:** 7481-0006  
**Pressure Rating:** 10,000 psi  
**Weight:** 28 lbs

## SHOP AIR PUMP ▶

Works off standard shop air (90 psi). Economical, convenient and versatile for use wherever 90 psi compressed air is available.

**Part Number:** 77820  
**Product Number:** 7481-0002  
**Pressure Rating:** 10,000 psi  
**Weight:** 12 lbs



## ◀ 1/2 HP 115 VOLT AC PUMP

Medium speed. Economical. Recommended for a stationary or mobile application.

**Part Number:** 77441  
**Product Number:** 7481-0034  
**Pressure Rating:** 10,000 psi  
**Weight:** 37 lbs



## 1-1/2 HP 115 VOLT AC PUMP ▶

High speed. Recommended for stationary applications only.

**Part Number:** 77442  
**Product Number:** 7481-0035  
**Pressure Rating:** 10,000 psi  
**Weight:** 87 lbs



## BATTERY PUMP ▲

Cordless, lightweight design with integrated handle and carrying strap. 1/2 horsepower motor and two 28V Lithium-Ion Milwaukee M28 batteries. High-strength fiberglass reinforced composite pump shroud for superior durability.

**Part Number:** 70187  
**Product Number:** 7481-0011  
**Weight:** 24 lbs



## ◀ 1/4 HP 12 VOLT DC PUMP

Mobile operation, runs on standard 12V car/truck battery or a 12V portable battery pack. Ideal for tough jobs in the field.

**Part Number:** 77439  
**Product Number:** 7481-0037  
**Pressure Rating:** 10,000 psi  
**Weight:** 20 lbs





# POWER CRIMP® 707

Gates Power Crimp® 707 is the most reliable, yet simplest crimper made. It was the first crimper with electronic digital readout to indicate gauge setting. The toughest part about using the 707 is pushing a button. It takes just a few seconds to make factory-quality hose assemblies.

Crimps most hydraulic hose from low pressure return lines to extremely high pressure spirals, from 3/16" to 1-1/4" I.D. Crimps straight and bent tube couplings, plus 45° and 90° block types. Can also be adapted for use as a power swager.

## SPECIFICATIONS

**Part Number:** 77700  
**Product Number:** 7480-0043  
 Standard PC707 without die sets wired for 115V (includes die backup ring and a no-notched cone).  
**Production Rate:** 100 assemblies per hour (using 1/2" I.D. two-wire straight thread assemblies).

**Dimensions:** 13" wide by 12" deep by 26-1/2" high.  
**Weight:** 214 lbs

**PC707 230V Converter Kit**  
 Converts crimper and pump  
**Part Number:** 78760  
**Product Number:** 7482-0499



## Power Crimp® 707 Die Selection Table

### For MegaCrimp® (G25) Couplings

Hose Type	Hose Sizes						
	1/4"	3/8"	1/2"	5/8"	3/4"	1"	1-1/4"
M3K	721 or 731	722 or 732	733	734	735	737	—
M2T	721 or 731	722 or 732	733	734	735	737	720
G1	721 or 731	722 or 732	733	734	735	737	739
G2	721 or 731	722 or 732	733	734	735	737	739

### For GlobalSpiral™ (G20) Couplings

Hose Type	Hose Sizes						
	3/8"	1/2"	5/8"	3/4"	1"	1-1/4"	
EFG6K	733	733	735	735	737	—	
EFG5K	733	733	735	735	737	—	
EFG4K	733	733	735	735	737	739	

For other hose and coupling configurations, reference [www.gates.com/ecrimp](http://www.gates.com/ecrimp) or Gates crimp data manual.

## Die Sets (ordered separately)

Die Set	721/731	722/732	733	734	735	737*	720*	739*
Part No.	78943/78931	78944/78932	78933	78934	78935	78937	78920	78939
Product No.	7482-1217/0931	7482-1218/0932	7482-0933	7482-0934	7482-0935	7482-0937	7482-0920	7482-0939

\* Must Use No-Notch Die Cone.

## Power Crimp® 707 Pump

The flows of two fixed displacement pumps are combined to deliver a high volume of oil at low pressure for fast transversion.

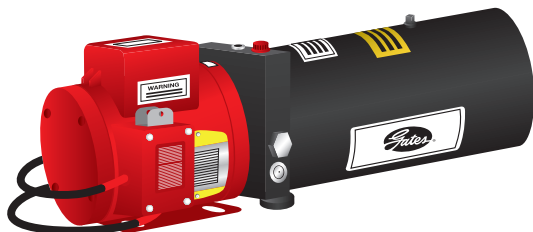

## SPECIFICATIONS

**Part Number:** 77810  
**Product Number:** 7481-0023  
 (115V, 30 amp, circuit, 1 hp, 60 cycles)  
**Dimensions:** 12" wide by 25" deep by 12" high.  
**Weight:** 79 lbs  
**Maximum Working Pressure:** 4,900 psi

## EQUIPMENT

- HOSE/CPLG. SELECTION
- G8K COUPLINGS
- GLOBALSPIRAL COUPLINGS
- STAINLESS STEEL SPIRAL
- MEGACRIMP COUPLINGS
- STAINLESS STEEL BRAID
- POWER CRIMP COUPLINGS
- FIELD ATTACHABLE G1 & G2 COUPLINGS
- FIELD ATTACHABLE C5 COUPLINGS
- C14 COUPLINGS
- GL COUPLINGS
- GLX COUPLINGS
- PCTS THERMOPLASTIC COUPLINGS
- POLARSEAL COUPLINGS (ACA)
- POLARSEAL II COUPLINGS (ACC)
- POLARSEAL II COUPLINGS (ACB)
- POWER STEERING
- ADAPTERS
- QUICK DISCONNECT COUPLERS
- BALL VALVES
- LIVE SWIVEL
- ASSEMBLY FABRICATION
- ACCESSORIES
- EQUIPMENT AND PARTS
- KITS
- AIR BRAKE HOSE ASSY
- BRASS



# GC® 32TSi™ CRIMPER

There's no room for error when replacing hydraulic hose assemblies. Gates GC® 32TSi™ innovative "smart" crimper leaves nothing to chance. All the necessary tools and information reside on-board to crimp rock-solid, leak-free, factory-quality hose assemblies. Gates GC32TSi crimper features a touch-screen control panel for easy navigation. It links to Gates eCrimp® database for up-to-the-minute crimp specifications and optimal hose/coupling selection. Advanced functionality such as pinch decompression, precision crimp diameter measurement, machined die retention plates with a simple die loading system, and a self-lubricating crimper head assist the operator in building factory-quality assemblies that meet Gates stringent crimping specifications.



## SPECIFICATIONS

**Part Number:** 78827  
**Product Number:** 7480-7004  
**Dimensions:** 23" wide by 19-1/2" deep by 37" high  
**Weight:** 557.4 lbs  
**Motor:** 5 hp  
**Pump:** 2-stage  
**Power Source:** 208-260V, 50-60 hz, 1 phase and 20 amp, (plug is a NEMA L6-20)

**Maximum Crimping Force:** 420 tons  
**Rack and Stand sold separately** - can be used with GC®32 and GC®96 crimpers  
**Stand: Part Number:** 78829  
**Product Number:** 7480-7002  
 31-3/4" wide by 16-1/2" deep (height adjustable) by 25-1/2" high  
**Die Rack: Part Number:** 78830  
**Product Number:** 7480-7003

### For GlobalSpiral™ (G20) Couplings

#### Hose Sizes

Hose Type	3/8"	1/2"	5/8"	3/4"	1"	1-1/4"
EFG6K	32-33	32-33	32-35	32-35	32-37	32-310L
EFG5K	32-33	32-33	32-35	32-35	32-37	32-310L
EFG4K	32-33	32-33	32-35	32-35	32-37	32-39

### For GSP (G22) & GSM (G23, G24) Couplings

#### Hose Sizes

Hose Type	1-1/2"	2"
EFG6K	32-311	32-314
EFG5K	32-311	32-314
EFG3K	32-311	32-313
G1H	32-310(L)	32-313
G2H	32-310(L)	32-312

### For MegaCrimp® (G25) Couplings

#### Hose Sizes

Hose Type	1/4"	3/8"	1/2"	5/8"	3/4"	1"	1-1/4"
M3K	32-21 or 32-31	32-22 or 32-32	32-33	32-34	32-35	32-37	—
M2T	32-21 or 32-31	32-22 or 32-32	32-33	32-34	32-35	32-37	32-38
G1	32-21 or 32-31	32-22 or 32-32	32-33	32-34	32-35	32-37	32-39
G2	32-21 or 32-31	32-22 or 32-32	32-33	32-34	32-35	32-37	32-39

### For LifeGuard® Sleeving

1/4"	3/8"	1/2"
32-3234	32-3335	32-3436
5/8"	3/4"	1"
32-3537	32-3638	32-38311

For other hose and coupling configurations, reference [www.gates.com/ecrimp](http://www.gates.com/ecrimp) or Gates crimp data manual.

## Die Sets (ordered separately)

Die Set	32-21	32-22	32-31	32-33	32-34	32-35	32-36
Part No.	78860	78861	78862	78863	78864	78865	78866
Product No.	7482-7128	7482-7129	7482-7130	7482-7131	7482-7132	7482-7133	7482-7134
Die Set	32-37	32-38	32-39	32-310L	32-311	32-312A	32-313
Part No.	78867	78868	78869	78870	78871	78872	78873
Product No.	7482-7135	7482-7136	7482-7137	7482-7138	7482-7139	7482-7140	7482-7141
Die Set	32-314	32-40D	32-41	32-42	32-43	32-44	32-46
Part No.	78874	78875	78876	78877	78878	78879	78880
Product No.	7482-7142	7482-7143	7482-7144	7482-7145	7482-7146	7482-7147	7482-7148
Die Set	32-81	32-82	32-83	32-72	32-84	32-85	32-86
Part No.	78881	78882	78883	78672	78884	78885	78886
Product No.	7482-7149	7482-7150	7482-7151	7482-7201	7482-7152	7482-7153	7482-7154
Die Set	32-331	32-45	32-3234	32-3335	32-3436	32-3537	32-3638
Part No.	78888	78889	78792	78790	78791	78776	78777
Product No.	7482-7156	7482-7157	7482-1419	7482-1420	7482-1421	7482-1430	7482-1431
Die Set	32-38311						
Part No.	78786						
Product No.	7482-1443						



# GC® 96TSi™-3 CRIMPER

The GC® 96TSi™-3 crimper is capable of crimping 3" six-wire and up to 6" I.D. industrial hose. This crimper allows distributors to make reliable and professional looking assemblies providing more value to the end user. The large crimper head allows industrial hose assemblies to be made with a variety of terminations using crimpable ferrules and sleeves. The GC96TSi crimper has additional versatility since in conjunction with optional spacer dies and GC® 32 dies; it can make Gates hydraulic hose assemblies also.

## SPECIFICATIONS

- Part Number:** 78392
- Product Number:** 7480-9003
- Dimensions:** 31" high by 32" wide by 16" deep
- Weight:** 650 lbs
- Power Source:** 208-264V, 45-65 hz, single phase and 20 amp
- Capability:** 1/4"– 3" Hydraulic hose and 1/4"– 6" Industrial hose



**Rack and Stand not pictured, sold separately.**

### For GlobalSpiral™ (G20) Couplings

Hose Type	Hose Sizes					
	3/8"	1/2"	5/8"	3/4"	1"	1-1/4"
EFG6K	32-33	32-33	32-35	32-35	32-37	32-310L
EFG5K	32-33	32-33	32-35	32-35	32-37	32-310L
EFG4K	32-33	32-33	—	32-35	32-37	32-39

### For GSP (G22) & GSM (G23, G24) Couplings

Hose Type	Hose Sizes	
	1-1/2"	2"
EFG6K	32-311	—
EFG5K	32-311	32-314
EFG3K	32-311	32-313
G1H	32-310(L)	32-313
G2H	32-310(L)	32-312

### For MegaCrimp® (G25) Couplings

Hose Type	Hose Sizes						
	1/4"	3/8"	1/2"	5/8"	3/4"	1"	1-1/4"
M3K	32-21 or 32-31	32-22 or 32-32	32-33	32-34	32-35	32-37	—
M2T	32-21 or 32-31	32-22 or 32-32	32-33	32-34	32-35	32-37	—
G1	32-21 or 32-31	32-22 or 32-32	32-33	32-34	32-35	32-37	32-39
G2	32-21 or 32-31	32-22 or 32-32	32-33	32-34	32-35	32-37	32-39

### For LifeGuard® Sleeving

	Hose Sizes		
	1/4"	3/8"	1/2"
	32-3234	32-3335	32-3436
	5/8"	3/4"	1"
	32-3537	32-3638	32-38311

For other hose and coupling configurations, reference [www.gates.com/ecrimp](http://www.gates.com/ecrimp) or Gates crimp data manual.

## Die Sets (ordered separately)

Die Set	32-21	32-22	32-31	32-33	32-34	32-35	32-36
Part No.	78860	78861	78862	78863	78864	78865	78866
Product No.	7482-7128	7482-7129	7482-7130	7482-7131	7482-7132	7482-7133	7482-7134
Die Set	32-37	32-38	32-39	32-310L	32-311	32-312A	32-313
Part No.	78867	78868	78869	78870	78871	78872	78873
Product No.	7482-7135	7482-7136	7482-7137	7482-7138	7482-7139	7482-7140	7482-7141
Die Set	32-314	32-40D	32-41	32-42	32-43	32-44	32-46
Part No.	78874	78875	78876	78877	78878	78879	78880
Product No.	7482-7142	7482-7143	7482-7144	7482-7145	7482-7146	7482-7147	7482-7148
Die Set	32-81	32-82	32-83	32-72	32-84	32-85	32-86
Part No.	78881	78882	78883	78672	78884	78885	78886
Product No.	7482-7149	7482-7150	7482-7151	7482-7201	7482-7152	7482-7153	7482-7154
Die Set	32-331	32-45	32-3234	32-3335	32-3436	32-3537	32-3638
Part No.	78888	78889	78792	78790	78791	78776	78777
Product No.	7482-7156	7482-7157	7482-1419	7482-1420	7482-1421	7482-1430	7482-1431
Die Set	32-38311						
Part No.	78786						
Product No.	7482-1443						

EQUIPMENT
HOSE/CPLG. SELECTION
G8K COUPLINGS
GLOBALSPIRAL COUPLINGS
STAINLESS STEEL SPIRAL
MEGACRIMP COUPLINGS
STAINLESS STEEL BRAID
POWER CRIMP COUPLINGS
FIELD ATTACHABLE G1 & G2 COUPLINGS
FIELD ATTACHABLE C5 COUPLINGS
C14 COUPLINGS
GL COUPLINGS
GLX COUPLINGS
PCTS THERMOPLASTIC COUPLINGS
POLARSEAL COUPLINGS (ACA)
POLARSEAL II COUPLINGS (ACC)
POLARSEAL II COUPLINGS (ACB)
POWER STEERING
ADAPTERS
QUICK DISCONNECT COUPLERS
BALL VALVES
LIVE SWIVEL
ASSEMBLY FABRICATION
ACCESSORIES
EQUIPMENT AND PARTS
KITS
AIR BRAKE HOSE ASSY
BRASS



## SC32™ CRIMPER

The Gates SC32™ crimper is a versatile, easy-to-use, economical machine suitable for a hard-working shop environment. It is offered in 110V and 220V single phase versions to match the shop power supply. This rugged crimper is designed for continued use to meet day-to-day shop and counter needs for crimps on hose up to 1-1/4" I.D. with occasional crimps for larger assemblies up to 2", 6-spiral hose.

**Part Number:** 77500

**Product Number:** 7480-0070

Wired for 220V with 2 hp electric pump

**Power Source:** 208-230VAC,

20 amp, single phase, 60 hz

**Part Number:** 77501

**Product Number:** 7480-0071

Wired for 110V with 1 hp electric pump

**Power Source:** 115VAC, 15

amp, 60 hz

### SPECIFICATIONS

**Dimensions:** 16.5" wide x 32" deep x 29" high

**Max. Rated Working**

**Pressure:** 10,000 psi

**Max. Crimping Force:** 80 tons

**Weight:** 435 lbs



## SC32™ Die Selection Table

### For GlobalSpiral™ (G20) Couplings

#### Hose Sizes

Hose Type	3/8"	1/2"	5/8"	3/4"	1"	1-1/4"
EFG3K	733	733	735	735	737	—
EFG4K	733	733	735	735	737	—
EFG5K	733	733	735	735	737	310L

### For GSP (G22) & GSM (G23, G24) Couplings

#### Hose Sizes

Hose Type	1-1/2"	2"
EFG6K	311	—
EFG5K	311	314
EFG3K	311	313
G1H	310(L)	313
G2H	310(L)	312

### For MegaCrimp® (G25) Couplings

#### Hose Sizes

Hose Type	1/4"	3/8"	1/2"	5/8"	3/4"	1"	1-1/4"
M3K	721 or 731	722 or 732	733	734	735	737	—
M2T	721 or 731	722 or 732	733	734	735	737	720
G1	721 or 731	722 or 732	733	734	735	737	739
G2	721 or 731	722 or 732	733	734	735	737	739

For other hose and coupling configurations, reference [www.gates.com/ecrimp](http://www.gates.com/ecrimp) or Gates crimp data manual.

## Die Sets (ordered separately)

Die Set	721/731	722/732	733	734	735	737*	720*	739*
Part No.	78943/78931	78944/78932	78933	78934	78935	78937	78920	78939
Product No.	7482-1217/0931	7482-1218/0932	7482-0933	7482-0934	7482-0935	7482-0937	7482-0920	7482-0939
Die Set	SC32-310L	SC32-311	SC32-312	SC32-313	SC32-314			
Part No.	78977	78978	78979	78980	78981			
Product No.	7482-1710	7482-1711	7482-1712	7482-1713	7482-1714			

\* Must Use No-Notch Die Cone.

EQUIPMENT
HOSE/CPLG. SELECTION
G8K COUPLINGS
GLOBALSPIRAL COUPLINGS
STAINLESS STEEL SPIRAL
MEGACRIMP COUPLINGS
STAINLESS STEEL BRAID
POWER CRIMP COUPLINGS
FIELD ATTACHABLE G1 & G2 COUPLINGS
FIELD ATTACHABLE C5 COUPLINGS
C14 COUPLINGS
GL COUPLINGS
GLX COUPLINGS
PCTS THERMOPLASTIC COUPLINGS
POLARSEAL COUPLINGS (ACA)
POLARSEAL II COUPLINGS (ACC)
POLARSEAL II COUPLINGS (ACB)
POWER STEERING
ADAPTERS
QUICK DISCONNECT COUPLERS
BALL VALVES
LIVE SWIVEL
ASSEMBLY FABRICATION
ACCESSORIES
EQUIPMENT AND PARTS
KITS
AIR BRAKE HOSE ASSY
BRASS



# POLARSEAL® PORTABLE CRIMPER



**Part Number:** 77716  
**Product Number:** 7480-6599

Gates PolarSeal® Portable Crimper is designed for crimping air conditioning assemblies by hand or impact wrench. The PolarSeal Portable Crimper has capability to crimp PolarSeal G45 and G47 couplings, and is intended for use with PolarSeal I and PolarSeal II refrigerant hose. Die included with the crimper have capability to crimp -6, -8, -10, and -12 PolarSeal I and PolarSeal II assemblies.

Hose	Part Number	Color	Fitting Prefix	Die Number
-6 PolarSeal II	78768	Red	6ACB-	6R
-6 PolarSeal I, -8 PolarSeal II	78656	Black	6ACA-, 8ACB-	6-8R
-8 PolarSeal I	78657	Blue	8ACA-	8
-10 PolarSeal II	78769	Almond	10ACB-	10R
-10 PolarSeal I, -12 PolarSeal II	78658	Green	10ACA, 12ACB	10-12R
-12 PolarSeal I	78659	Clear	12ACA	12

**Features:**

- Portable hand operation, easy to change over from size to size.
- Heavy-duty construction for use with air impact wrenches.
- Crimps two-braid dimension or reduced barrier hose.
- OE-style bubble crimp.
- Quick-change dies, no tools required to change sizes.
- Lightweight for easy handling, less than six pounds.
- Capable of crimping underhood air conditioning applications.
- Includes six color-coded die sets for crimping two-braid barrier hose and reduced barrier hose.
- Removable die holder accommodates complicated shapes.
- Color-coded, urethane encased dies.
- Unit can be bench-mounted.
- Shipped in a custom carrying case with instructions.
- No electrical requirements.
- Locator flag centers ferrule in dies.

EQUIPMENT
HOSE/CPLG. SELECTION
G8K COUPLINGS
GLOBALSPIRAL COUPLINGS
STAINLESS STEEL SPIRAL
MEGACRIMP COUPLINGS
STAINLESS STEEL BRAID
POWER CRIMP COUPLINGS
FIELD ATTACHABLE G1 & G2 COUPLINGS
FIELD ATTACHABLE C5 COUPLINGS
C14 COUPLINGS
GL COUPLINGS
GLX COUPLINGS
PCTS THERMOPLASTIC COUPLINGS
POLARSEAL COUPLINGS (ACA)
POLARSEAL II COUPLINGS (ACC)
POLARSEAL II COUPLINGS (ACB)
POWER STEERING
ADAPTERS
QUICK DISCONNECT COUPLERS
BALL VALVES
LIVE SWIVEL
ASSEMBLY FABRICATION
ACCESSORIES
EQUIPMENT AND PARTS
KITS
AIR BRAKE HOSE ASSY
BRASS

## POLARSEAL® II HOSE PLIERS



**Ratcheting Pliers**

**Straight Jaw Pliers**

**Notched Jaw Pliers**

The PolarSeal® II pliers are used to crimp the clamps on PolarSeal II (G46) couplings. The ratcheting pliers will not release until the crimp is complete guaranteeing a proper seal. The straight jaw pliers are used when there are no obstructions to hinder crimping. The notched jaw pliers are for use in tight quarters. Use the side or the front of the pliers to complete the crimp.

**Ratcheting Pliers**

**Part Number:** 77953

**Product Number:** 7369-5503

**Notched Jaw Pliers**

**Part Number:** 77951

**Product Number:** 7369-5501

**Straight Jaw Pliers**

**Part Number:** 77952

**Product Number:** 7369-5502

## HYDRAULIC HOSE REEL RACK



This sturdy and convenient rack stores three reels of hose.

**Part Number:** 78186

**Product Number:** 7484-0019

**Dimensions:** 28" wide by 30" deep by 72" high

EQUIPMENT
HOSE/CPLG. SELECTION
G8K COUPLINGS
GLOBAL SPIRAL COUPLINGS
STAINLESS STEEL SPIRAL
MEGACRIMP COUPLINGS
STAINLESS STEEL BRAID
POWER CRIMP COUPLINGS
FIELD ATTACHABLE G1 & G2 COUPLINGS
FIELD ATTACHABLE C5 COUPLINGS
C14 COUPLINGS
GL COUPLINGS
GLX COUPLINGS
PCTS THERMOPLASTIC COUPLINGS
POLARSEAL COUPLINGS (ACA)
POLARSEAL II COUPLINGS (ACC)
POLARSEAL II COUPLINGS (ACB)
POWER STEERING
ADAPTERS
QUICK DISCONNECT COUPLERS
BALL VALVES
LIVE SWIVEL
ASSEMBLY FABRICATION
ACCESSORIES
EQUIPMENT AND PARTS
KITS
AIR BRAKE HOSE ASSY
BRASS





# HYDRAULIC COUPLING CABINET

## Customized to fit all your needs!

Now even more versatile, these easy-to-assemble units are compactly designed to give you years of reliable service. Components are ordered individually by product number for easy customization.

### 1. MobileCrimp® 4-20

Pre-drilled holes in mounting shelf (item #2 below) allows easy mounting of either the Positive Stop or Digital Dial MobileCrimp® 4-20 crimper.

**Safety Hint:**

If the MobileCrimp 4-20 is mounted on top of the cabinet, you **must**:

- Use crimper mounting shelf (item #2 below)
- Bolt shelf and cabinet to wall using pre-drilled holes
- Not use the caster leg set

### 2. Mounting Shelf for MC 4-20 Crimper

**Part Number:** 78193

**Product No.** 7484-0013

### 3. Coupling Cabinet with Four Sliding Shelves (Two Shown)

**Part Number:** 78190

**Product No.** 7484-0010

Shelves slide out for easy access and can hold a combination of ten 3-1/2" wide bin boxes or five 7" wide bin boxes. Unit can be stacked and bolted together as shown in illustration. Each measures 41" wide by 12" deep by 21" high.

**Safety Hint:**

Slide open only one shelf at a time to avoid tipping.

### 4. Stationary Legs (Shown)

**Part Number:** 78191

**Product No.** 7484-0011

Allows for precise leveling.

### Heavy-Duty Caster Leg Set (Not Shown)

**Part Number:** 78192

**Product No.** 7484-0012

Set consists of four heavy-duty casters, two of which can be locked.

### 5. Bin Boxes

Order separately in whatever combination best fits your needs.

Dividers come with each bin box. Each bin box has slots to allow for maximum utilization.



**When assembled, the typical combination of two four-shelf coupling cabinets and stationary leg set as shown measures 41" wide by 12" deep by 48" high.**

Description	Part Number	Product Number
Ten 3.5" wide bins with 15 dividers	78194	7484-0014
Five 7" wide bins with 9 dividers	78195	7484-0015
Three dividers for 3.5" wide bin box	78196	7484-0016
Three dividers for 7" wide bin box	78197	7484-0017
Sixty dividers for 3.5" wide bin box	78199	7484-0031

EQUIPMENT
HOSE/CPLG. SELECTION
G8K COUPLINGS
GLOBALSPIRAL COUPLINGS
STAINLESS STEEL SPIRAL
MEGACRIMP COUPLINGS
STAINLESS STEEL BRAID
POWER CRIMP COUPLINGS
FIELD ATTACHABLE G1 & G2 COUPLINGS
FIELD ATTACHABLE C5 COUPLINGS
C14 COUPLINGS
GL COUPLINGS
GLX COUPLINGS
PCTS THERMOPLASTIC COUPLINGS
POLARSEAL COUPLINGS (ACA)
POLARSEAL II COUPLINGS (ACC)
POLARSEAL II COUPLINGS (ACB)
POWER STEERING
ADAPTERS
QUICK DISCONNECT COUPLERS
BALL VALVES
LIVE SWIVEL
ASSEMBLY FABRICATION
ACCESSORIES
EQUIPMENT AND PARTS
KITS
AIR BRAKE HOSE ASSY
BRASS



EQUIPMENT
HOSE/CPLG. SELECTION
G8K COUPLINGS
GLOBAL SPIRAL COUPLINGS
STAINLESS STEEL SPIRAL
MEGACRIMP COUPLINGS
STAINLESS STEEL BRAID
POWER CRIMP COUPLINGS
FIELD ATTACHABLE G1 & G2 COUPLINGS
FIELD ATTACHABLE C5 COUPLINGS
C14 COUPLINGS
GL COUPLINGS
GLX COUPLINGS
PCTS THERMOPLASTIC COUPLINGS
POLARSEAL COUPLINGS (ACA)
POLARSEAL II COUPLINGS (ACC)
POLARSEAL II COUPLINGS (ACB)
POWER STEERING
ADAPTERS
QUICK DISCONNECT COUPLERS
BALL VALVES
LIVE SWIVEL
ASSEMBLY FABRICATION
ACCESSORIES
EQUIPMENT AND PARTS
KITS
AIR BRAKE HOSE ASSY
BRASS

## VERTICAL HYDRAULIC HOSE CABINET



**Part Number:** 78188

**Product Number:** 7484-0022

Rack up sales and get organized at the same time with a new 'vertical' hydraulic hose cabinet from Gates.

- Six narrow and two wide slots to stock a variety of hydraulic hose.
- Designed to support one hydraulic coupling cabinet on top for maximum efficiency.
- Optional choice for use as cabinet base with maximum of one four-drawer cabinet.
- Measures 41" wide by 12" deep (top), 36" high.
- Shown with four-drawer cabinet

Purchase separately as:

**Part Number:** 78190

**Product No.:** 7484-0010

## TWO-DRAWER COUPLING CABINET



**Part Number:** 78189

**Product No.** 7484-0021

This two-drawer cabinet is ideal to add nylon air brake tubing couplings to your hydraulic inventory. This cabinet can be stacked and bolted together with your existing hydraulic cabinet. Uses the same bin boxes as listed above. Measures 41" wide by 12" deep by 11" high.

## WORK BENCH



**Part Number:** 78022

**Product Number:** 7484-0020

**Dimensions:** 36" wide by 24" deep by 36" high

This new hydraulic work bench is ideal for holding either the Power Crimp® 707 or MobileCrimp® 4-20 crimpers as well as hydraulic saws. The lower shelf can be used for storage or as shown with the pump. It is made of an angle iron frame construction with a high-density fiberboard top and welded 13-gauge steel lower shelf. All hardware is included to allow for easy assembly in about 10 minutes.

**Note:** Crimpers must be bolted down to the table top.



## HYDRAULIC COUPLING BIN

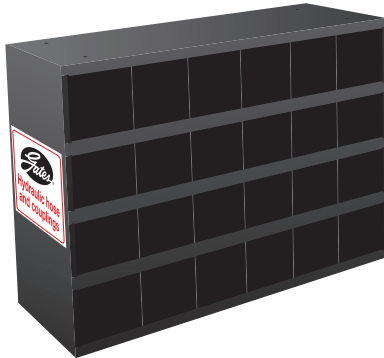

**Part Number:** 78207  
**Product Number:** 7484-0007

The 24-bin cabinet is constructed of heavy gauge steel. Cabinet measures 34" wide by 12" deep by 24" high. Excellent for storing large 1-1/4" to 2" I.D. couplings.

## COUPLING BIN BOXES



**Part Number:** 78208  
**Product Number:** 7484-0008

Bin boxes for hydraulic couplings. Corrugated cardboard design gives extra strength. Includes four dividers per box.

**Measures:** 5" wide by 11" deep by 4-1/2" high.

**Part Number:** 78212  
**Product Number:** 7484-0009  
**Measures:** 7-1/2" wide by 11" deep by 4-1/2" high

## GATES HOSE CUTTER MODEL 1.5" Two-Wire Shop Saw

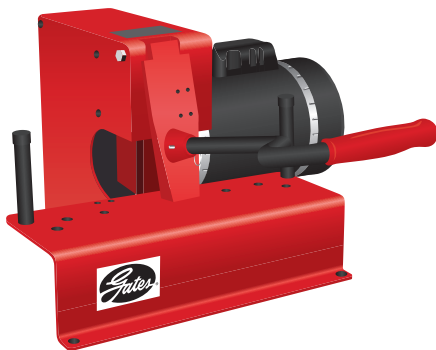

**Replacement Blade**  
**Part Number:** 78003  
**Product Number:** 7482-1329

For two-wire braid hose through 1-1/2" I.D.

**Part Number:** 78084  
**Product Number:** 7480-6607  
**Clean Easy Cuts – Safe Operation**

### FEATURES:

- Cuts up to 1-1/2" I.D. two-wire braid hose and 1" four-wire spiral hose.
- Designed to operate on standard 20 amp service.
- Reversible 8" scalloped-edge, high-speed steel blade with 5/8" bore can be sharpened.
- Radius hose feed into blade for safety and reduced friction.
- Inner blade guard for safe operation.

### SPECIFICATIONS

**Power Source:** 1-1/2 hp (2.6 hp peak), 115V, 60 hz, 15 amp motor with power cord and plug.

**Dimensions:** 13" wide by 24" deep by 17" high.

**Weight:** 151 lbs

EQUIPMENT
HOSE/CPLG. SELECTION
G8K COUPLINGS
GLOBAL SPIRAL COUPLINGS
STAINLESS STEEL SPIRAL
MEGACRIMP COUPLINGS
STAINLESS STEEL BRAID
POWER CRIMP COUPLINGS
FIELD ATTACHABLE G1 & G2 COUPLINGS
FIELD ATTACHABLE C5 COUPLINGS
C14 COUPLINGS
GL COUPLINGS
GLX COUPLINGS
PCTS THERMOPLASTIC COUPLINGS
POLARSEAL COUPLINGS (ACA)
POLARSEAL II COUPLINGS (ACC)
POLARSEAL II COUPLINGS (ACB)
POWER STEERING
ADAPTERS
QUICK DISCONNECT COUPLERS
BALL VALVES
LIVE SWIVEL
ASSEMBLY FABRICATION
ACCESSORIES
EQUIPMENT AND PARTS
KITS
AIR BRAKE HOSE ASSY
BRASS

## GATES 28VDC PORTABLE HYDRAULIC HOSE SAW



**Part Number:** 78394

**Product Number:** 7480-6610

### FEATURES:

- Battery power provides unmatched portability. Uses the same Milwaukee M28 battery as the GC® 16XD™ Crimper Battery Pump. Battery sold separately.
- Cuts up to 1", 4-spiral hose.
- Safety "C" clamp secures saw in cutting position.
- Quick adjusting locator pins make changing hose sizes easy.

### SPECIFICATIONS

**Dimensions:** 12" wide by 8" deep by 19" high

**Weight:** 16 lbs

**Wheel Type:** Abrasive

**Wheel Diameter:** 6"

**No Load RPM:** 8000

**Arbor:** 7/8"

**Spindle Thread Size:** 5/8"-11"

**Switch Type:** Slide

**Soft Start:** Large Spindle Lock

**Battery Included:** No

**Battery Type:** LI-ION

**Battery Voltage:** 28V

**Battery Capacity:** 3.0AH

**Series:** M28™

**Battery Pack Replacement:** 5AB52

M28™ is a trademark of Milwaukee Tools.

EQUIPMENT
HOSE/CPLG. SELECTION
G8K COUPLINGS
GLOBAL SPIRAL COUPLINGS
STAINLESS STEEL SPIRAL
MEGACRIMP COUPLINGS
STAINLESS STEEL BRAID
POWER CRIMP COUPLINGS
FIELD ATTACHABLE G1 & G2 COUPLINGS
FIELD ATTACHABLE C5 COUPLINGS
C14 COUPLINGS
GL COUPLINGS
GLX COUPLINGS
PCTS THERMOPLASTIC COUPLINGS
POLARSEAL COUPLINGS (ACA)
POLARSEAL II COUPLINGS (ACC)
POLARSEAL II COUPLINGS (ACB)
POWER STEERING
ADAPTERS
QUICK DISCONNECT COUPLERS
BALL VALVES
LIVE SWIVEL
ASSEMBLY FABRICATION
ACCESSORIES
EQUIPMENT AND PARTS
KITS
AIR BRAKE HOSE ASSY
BRASS



## GATES POWER CUTTER 208

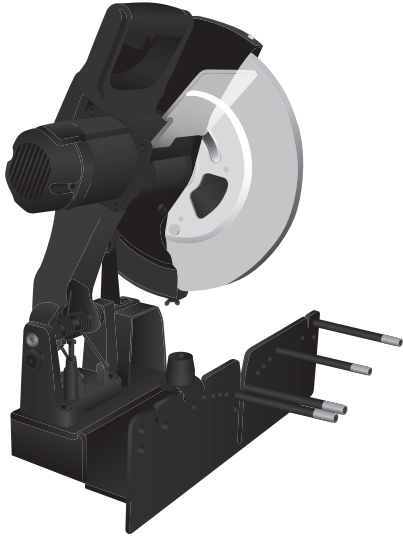

**Caution:** Keep blade sharp. Heat generated by a dull blade can damage steel and flare the hose.

### BLADE SPECIFICATION

**Blade Dimensions:** 12" by 1/8"

**Scalloped Replacement**

**Part Number:** 78009

**Product Number:** 7482-0983

**Optional Abrasive**

**Part Number:** 78011

**Product Number:** 7482-0426

**Part Number:** 78028

**Product Number:** 7480-6609

### Effortless Straight Cuts Every Time

- Clear face shield for added safety.
- Powerful high torque, 4.5 horsepower peak motor that makes cutting faster and easier.
- Includes scalloped, 12" blade to dissipate heat, reducing friction for clean, faster cuts up to 1-1/4" I.D.
- Optional abrasive blade for continuous use with 1-1/4" I.D. and larger spiral-wire reinforced hose.
- Safely cuts two and four-wire hose through 2", six-wire hose through 1-1/4".
- Reversible blade can be sharpened; removal and installation is easy.
- Cuts small 3/16" I.D. hose and handles the tough job including 2" I.D. spiral-wire hose.\*
- Easy to use, front face plate with moveable pins holds hose securely for a clean straight cut.
- Sturdy blade guard shields blade for safety.
- Permanent mounting brackets (included) to attach saw to table.

\*Optional abrasive blade preferred for cutting spiral-wire hose, larger than 1-1/4" I.D.

### CUTTER SPECIFICATIONS

**Shaft/Arbor Hole Diameter:** 1"

**Power Source:** 4.5 hp peak, 115/50/60 hz, 20 amp

**No Load Speed:** 3,500 rpm

**Dimensions:** 22-1/2" wide by 18-1/4" deep by 23-1/2" high

**Weight:** 83.4 lbs

## GATES HOSE CUTTER MODEL 2" Six-Wire Shop Saw

For six-wire spiral and two-wire braid hose through 2" I.D.

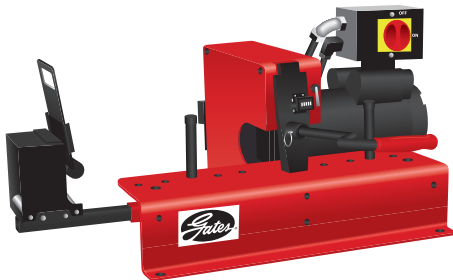

### SPECIFICATIONS

**Dimensions:** 22" wide by 42" deep by 24" high

**Weight:** 195 lbs

**Replacement Blade**

**Part Number:** 78003

**Product Number:** 7482-1329

**Part Number:** 78083

**Product Number:** 7480-6606

**Clean Easy Cuts – Safe Operation**

### FEATURES:

- Cuts up to 2" I.D. two-wire braid through six-spiral reinforced hose.
  - Reversible 10" scalloped-edge, high-speed steel blade with 3/4" bore, can be sharpened.
  - Radius hose feed into blade for safety and reduced friction.
  - Inner blade guard for safe operation.
  - **Includes Coolant Spray System Kit** for reduced heat in high-capacity cutting applications (recommended for multi-braid and spiral reinforced hose). Kit includes reservoir, spray nozzle and mounting hardware.
  - **Power cord not included.**
- Power Source:** 3 hp (5.2 hp peak), Single phase, 230V, 60 hz, 20 amp motor

### EQUIPMENT

HOSE/CPLG. SELECTION

G8K COUPLINGS

GLOBAL SPIRAL COUPLINGS

STAINLESS STEEL SPIRAL

MEGACRIMP COUPLINGS

STAINLESS STEEL BRAID

POWER CRIMP COUPLINGS

FIELD ATTACHABLE G1 & G2 COUPLINGS

FIELD ATTACHABLE C5 COUPLINGS

C14 COUPLINGS

GL COUPLINGS

GLX COUPLINGS

PCTS THERMOPLASTIC COUPLINGS

POLARSEAL COUPLINGS (ACA)

POLARSEAL II COUPLINGS (ACC)

POLARSEAL II COUPLINGS (ACB)

POWER STEERING

ADAPTERS

QUICK DISCONNECT COUPLERS

BALL VALVES

LIVE SWIVEL

ASSEMBLY FABRICATION

ACCESSORIES

EQUIPMENT AND PARTS

KITS

AIR BRAKE HOSE ASSY

BRASS

## GATES HS-1 HAND SWAGER

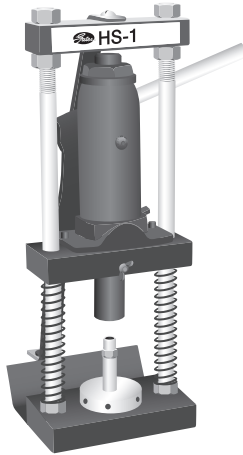

**Part Number:** 78080

**Product Number:** 7483-1000

Produces top quality assemblies using Gates 1/8" (-2) and 3/16" (-3) thermoplastic hydraulic hose with Gates PCTS couplings and Gates C14 PTFE hose and couplings 3/16 (-4) through 7/8 (-16).

Simply insert the assembly into the swager from the bottom, place dies around the coupling, and pump the handle.

A six-ton jack then goes to work and the swage is completed. Positive dies ensure a correct swage every time. The perfectly swaged assembly is removed and you are ready to repeat the process. Pushers and dies must be ordered separately.

### SPECIFICATIONS

**Dimensions:** 15" wide by 7" deep by 19-1/2" high

**Weight:** 41 lbs

## HAND-HELD HOSE CUTTER

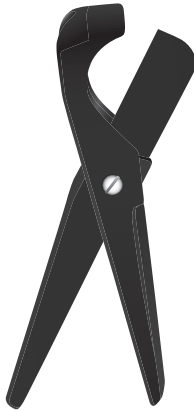

**Part Number:** 91153

**Product Number:** 7469-0153

Makes clean cuts—no ragged edges. Cuts most non-metal reinforced rubber hose. Excellent for cutting textile-reinforced hose.

### FEATURES:

- Lightweight with nylon handles.
- Blade closes into handle for safety.
- Cutter and blades packaged individually on shrink-wrapped cards.

### Replacement Blade

**Part Number:** 91154

**Product Number:** 7469-0154

## SWAGER CONVERSION KIT FOR THE POWER CRIMP® 707

Produces top quality assemblies using Gates 1/8" and 3/16" thermoplastic hydraulic hose with Gates PCTS couplings and Gates C14 PTFE hose and couplings. Easily converts the Power Crimp 707 to a power swager.

Description	Part Number	Product Number
Complete Kit	78081	7480-0040
Collar	78820	7482-0429
Die Cone	78821	7482-0430
Adapter	78824	7482-0433
Actuator Rod	78753	7482-0482
1/2" Spacer Ring	78184	7482-1253

Dies and pushers must be ordered separately. See Swage Data Chart in Gates Crimp Data Manual for details.

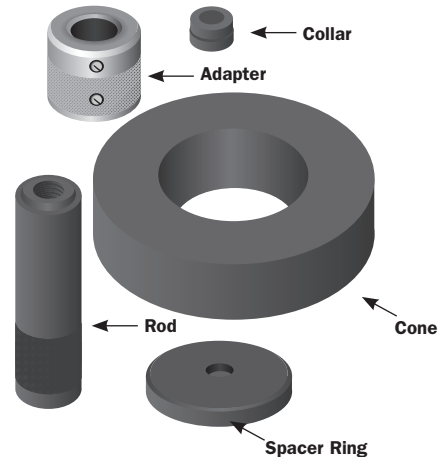

EQUIPMENT
HOSE/CPLG. SELECTION
G8K COUPLINGS
GLOBAL SPIRAL COUPLINGS
STAINLESS STEEL SPIRAL
MEGACRIMP COUPLINGS
STAINLESS STEEL BRAID
POWER CRIMP COUPLINGS
FIELD ATTACHABLE G1 & G2 COUPLINGS
FIELD ATTACHABLE C5 COUPLINGS
C14 COUPLINGS
GL COUPLINGS
GLX COUPLINGS
PCTS THERMOPLASTIC COUPLINGS
POLARSEAL COUPLINGS (ACA)
POLARSEAL II COUPLINGS (ACC)
POLARSEAL II COUPLINGS (ACB)
POWER STEERING
ADAPTERS
QUICK DISCONNECT COUPLERS
BALL VALVES
LIVE SWIVEL
ASSEMBLY FABRICATION
ACCESSORIES
EQUIPMENT AND PARTS
KITS
AIR BRAKE HOSE ASSY
BRASS



## C14 HOSE INSERTION DIE HOLDER FOR USE WITH HOSE INSERTION DIES

Required for inserting hose into ferrule on all sizes. Use the fixture (see photo) to mount the Hose Insertion Die Holder onto a bench top to aid in the assembly of Gates C14 hose. Each item listed in the next page must be ordered separately.

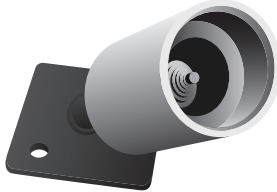

**Hose Insertion Die Holder**  
**Part Number:** 78518  
**Product Number:** 7483-0510

**Hose Insertion Fixture**  
**Part Number:** 78517  
**Product Number:** 7483-0511

## C14 HOSE INSERTION DIES

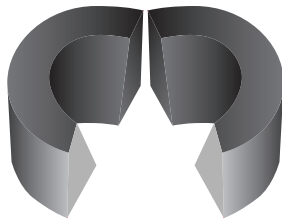

Used to guide the hose into the ferrule when used with the Hose Insertion Die Holder. One set required for each hose size. See product numbers listed in Gates Crimp Data and Dies Manual.

## C14 HOSE EXPANDERS

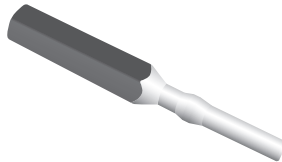

Used to expand the hose and round out the tube after cutting and to insert the stem into the hose. One expander required for each hose size. See product numbers listed in Gates Crimp Data and Dies Manual.

## C14 SWAGE PUSHERS



Specially designed to accommodate Gates C14 couplings. They protect the threads and bottom out on the dies to complete the swage. Use the C14 Swage Data Chart in Gates Crimp Data and Dies Manual to determine the proper pushers.

## C14 SWAGE DIES

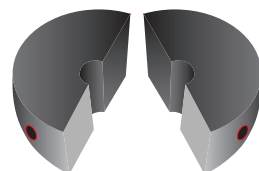

Specifically designed to swage Gates C14 hose assemblies. They provide the required swage dimensions to meet full performance. One die set is required for each hose size. See product numbers listed in Gates Crimp Data and Dies Manual.

### EQUIPMENT

HOSE/CPLG. SELECTION

G8K COUPLINGS

GLOBALSPIRAL COUPLINGS

STAINLESS STEEL SPIRAL

MEGACRIMP COUPLINGS

STAINLESS STEEL BRAID

POWER CRIMP COUPLINGS

FIELD ATTACHABLE G1 & G2 COUPLINGS

FIELD ATTACHABLE C5 COUPLINGS

C14 COUPLINGS

GL COUPLINGS

GLX COUPLINGS

PCTS THERMOPLASTIC COUPLINGS

POLARSEAL COUPLINGS (ACA)

POLARSEAL II COUPLINGS (ACC)

POLARSEAL II COUPLINGS (ACB)

POWER STEERING

ADAPTERS

QUICK DISCONNECT COUPLERS

BALL VALVES

LIVE SWIVEL

ASSEMBLY FABRICATION

ACCESSORIES

EQUIPMENT AND PARTS

KITS

AIR BRAKE HOSE ASSY

BRASS



## PUSHERS AND DIES FOR C14 HOSE AND COUPLINGS

EQUIPMENT
HOSE/CPLG. SELECTION
G8K COUPLINGS
GLOBAL SPIRAL COUPLINGS
STAINLESS STEEL SPIRAL
MEGACRIMP COUPLINGS
STAINLESS STEEL BRAID
POWER CRIMP COUPLINGS
FIELD ATTACHABLE G1 & G2 COUPLINGS
FIELD ATTACHABLE C5 COUPLINGS
C14 COUPLINGS
GL COUPLINGS
GLX COUPLINGS
PCTS THERMOPLASTIC COUPLINGS
POLARSEAL COUPLINGS (ACA)
POLARSEAL II COUPLINGS (ACC)
POLARSEAL II COUPLINGS (ACB)
POWER STEERING
ADAPTERS
QUICK DISCONNECT COUPLERS
BALL VALVES
LIVE SWIVEL
ASSEMBLY FABRICATION
ACCESSORIES
EQUIPMENT AND PARTS
KITS
AIR BRAKE HOSE ASSY
BRASS

### C14 Swage Pushers

Description	Part Number	Product Number
P-C14-4FJSX	78500	7483-0536
P-C14-5FJSX	78501	7483-0537
P-C14-6FJX	78502	7483-0538
P-C14-6FSX	78503	7483-0539
P-C14-8FJSX	78504	7483-0540
P-C14-10FJSX	78505	7483-0541
P-C14-12FJX	78506	7483-0542
P-C14-12FSX	78507	7483-0543
P-C14-16FJSX	78508	7483-0544
P-C14-2MP	78510	7483-0550
P-C14-4MP	78511	7483-0545
P-C14-6MP	78512	7483-0546
P-C14-8MP-8 & 10ABC	78513	7483-0547
P-C14-12MP-12ABC	78514	7483-0548
P-C14-16MP	78515	7483-0549
P-C14-4TUBE	78548	7483-0530
P-C14-5TUBE	78549	7483-0531
P-C14-6TUBE	78550	7483-0532
P-C14-8TUBE	78551	7483-0533
P-C14-10TUBE	78552	7483-0534
P-C14-12TUBE	78553	7483-0521
P-C14-12TUBE-JS	78554	7483-0522
P-C14-16TUBE-JS	78555	7483-0580
P-C14-6TBFLX	78565	7483-0552
P-C14-12TBFLX	78568	7483-0553
P-C14-16TBFLX	78569	7483-0554

### C14 Hose and Expanders

Description	Part Number	Product Number
HE-4C14	78530	7483-0555
HE-5C14	78531	7483-0556
HE-6C14	78532	7483-0557
HE-8C14	78533	7483-0558
HE-10C14	78534	7483-0559
HE-12C14	78535	7483-0560
HE-16C14	78536	7483-0561

### C14 Hose Insertion Dies

Description	Part Number	Product Number
HD-4C14	78521	7483-0503
HD-5C14	78522	7483-0504
HD-6C14	78523	7483-0505
HD-8C14	78524	7483-0506
HD-10C14	78525	7483-0507
HD-12C14	78526	7483-0508
HD-16C14	78527	7483-0509

### C14 Swage Dies

Description	Part Number	Product Number
SD-4C14	78539	7483-0513
SD-5C14	78540	7483-0514
SD-6C14	78541	7483-0515
SD-8C14	78542	7483-0516
SD-10C14	78543	7483-0517
SD-12C14	78544	7483-0518
SD-16C14	78545	7483-0519

## C14 HOSE CUTTING SHEAR RECOMMENDED FOR C14 PTFE HOSE



**Part Number:** 78006

**Product Number:** 7480-6596

This cutting shear handles Gates C14 PTFE hose up through 1" without requiring pre-taping of the hose. The shear is fast and easy to use and results in a very clean cut.

**Weight:** 23 lbs

**Dimensions:** 9" wide by 14" deep by 15" high. 30" handle.



## MEGACRIMP® COUPLING INSERTION TOOL



**Part Number:** 78017  
**Product Number:** 7482-1342

Offers an easy way to confirm the right insertion depth for all Gates wire-braid hydraulic hose. To use, simply insert the hose into its proper slot indicated by dash size, push it all the way in, check for square cut (maximum allowable angle of cut is five degrees), then mark the insertion depth on the hose.

## LOCK-ON TOOL



**Part Number:** 78050  
**Product Number:** 7480-0100

This hand-operated coupling machine, made of rugged cast iron and steel construction, eliminates the hard work of manually pushing stems into hose. It comes complete with mandrels for 1/4", 3/8", 1/2", 5/8" and 3/4" I.D. sizes of lock-on couplings.

## HAND-OPERATED HOSE PERFORATOR TOOL



These hose perforators have needle-studded wooden rollers which perforate the covers of non-skive wire braid hose used in high pressure inert gas applications. They are hand-operated so the operator can control the degree of perforation in the hose cover.

### 1-1/4" Hose Perforator for 3/16" to 3/4" I.D. Hose

**Part Number:** 78070  
**Product Number:** 7482-6565  
**Dimensions:** 2-1/2" O.D. roller by 1-1/4" wide by 8" OAL.  
**Weight:** 1 lb

### 3" Hose Perforator for 1" to 2" I.D. Hose

**Part Number:** 78071  
**Product Number:** 7482-6566  
**Dimensions:** 3-3/4" O.D. roller by 3" wide by 9-1/2" OAL.  
**Weight:** 2 lbs

EQUIPMENT
HOSE/CPLG. SELECTION
G8K COUPLINGS
GLOBALSPIRAL COUPLINGS
STAINLESS STEEL SPIRAL
MEGACRIMP COUPLINGS
STAINLESS STEEL BRAID
POWER CRIMP COUPLINGS
FIELD ATTACHABLE G1 & G2 COUPLINGS
FIELD ATTACHABLE C5 COUPLINGS
C14 COUPLINGS
GL COUPLINGS
GLX COUPLINGS
PCTS THERMOPLASTIC COUPLINGS
POLARSEAL COUPLINGS (ACA)
POLARSEAL II COUPLINGS (ACC)
POLARSEAL II COUPLINGS (ACB)
POWER STEERING
ADAPTERS
QUICK DISCONNECT COUPLERS
BALL VALVES
LIVE SWIVEL
ASSEMBLY FABRICATION
ACCESSORIES
EQUIPMENT AND PARTS
KITS
AIR BRAKE HOSE ASSY
BRASS

## EQUIPMENT

HOSE/CPLG.  
SELECTION

G8K COUPLINGS

GLOBAL SPIRAL  
COUPLINGSSTAINLESS  
STEEL SPIRALMEGACRIMP  
COUPLINGSSTAINLESS  
STEEL BRAIDPOWER CRIMP  
COUPLINGSFIELD  
ATTACHABLE G1  
& G2 COUPLINGSFIELD  
ATTACHABLE C5  
COUPLINGS

C14 COUPLINGS

GL COUPLINGS

GLX COUPLINGS

PCTS  
THERMOPLASTIC  
COUPLINGSPOLARSEAL  
COUPLINGS  
(ACA)POLARSEAL II  
COUPLINGS  
(ACC)POLARSEAL II  
COUPLINGS  
(ACB)POWER  
STEERING

ADAPTERS

QUICK  
DISCONNECT  
COUPLERS

BALL VALVES

LIVE SWIVEL

ASSEMBLY  
FABRICATION

ACCESSORIES

EQUIPMENT AND  
PARTS

KITS

AIR BRAKE HOSE  
ASSY

BRASS

## MEGACLEAN™ SYSTEM

Used to remove dirt from the inside out with the help of pressurized launchers and compatible nozzles. Gates MegaClean™ foam projectiles sweep through the inside surface of the hose, taking fine particles of loose dirt and other contaminants with them. At 20–30 percent larger than the hose I.D., these projectiles leave nothing behind but a hose that truly is clean from the inside out.

### MegaClean MC-K32 Kit

**Part Number:** MC-K32

**Product Number:** 7467-0001

- MCL-32 Hand Launcher (Including “Rotary” Plug & Coupler)
- MC-GAR-1 Adapter Ring (-4 thru -20)
- LC32 Carrying & Storage Case
- Hose Nozzles GH-04, GH-05, GH-06, GH-08, GH-10, GH-12, GH-16, GH-20, GH-24, GH-32
- JIC Assembly Nozzles GA-04, GA-06, GA-08, GA-10, GA-12, GA-16, GA-20, GA-24, GA-32
- GA-04-FFORX Nozzle
- MC-32 Launcher Stand
- 1 Projectile Catcher Bucket
- 1 Bag of Projectiles Listed in Chart Below



### MegaClean MC-K20 Kit (Hose 1/4" – 1 1/4")

**Part Number:** MC-K20

**Product Number:** 7467-0002

- MCL-20 Hand Launcher
- Female Quick-Release Coupler
- LC20 Carrying & Storage Case
- GH-04, GH-05, GH-06, GH-08, GH-10, GH-12, GH-16, GH-20 Hose Nozzles
- 1 Projectile Catcher Bucket
- 1 Bag of Projectiles Listed in Chart Below

### MegaClean Projectiles Included in Kits

Part Number	Product Number	MC-K32	MC-K20	Bag Quantity
MC-HAP-04-1	7467-50005	X	X	100
MC-HP-04	7467-50025	X	X	100
MC-HAP-06	7467-50035	X	X	100
MC-HP-06	7467-50045	X	X	100
MC-HAP-08	7467-50055	X	X	100
MC-HP-08	7467-50065	X	X	100
MC-HP-08-1	7467-50075	X	X	50
MC-HP-10	7467-50085	X	X	50
MC-HP-12	7467-50105	X	X	50
MC-HP-16	7467-50135	X	X	40
MC-HP-20	7467-50155	X	X	30
MC-HP-24	7467-50175	X		20
MC-HP-32	7467-50195	X		15

## How it works:



**Step 1**



**Step 2**



# MegaClean™ System Replacement Projectiles

Description	Product Number	Part Number
MegaClean HAP-04-1 Assembly Projectile (100 ea)	7467-50005	MC-HAP-04-1
MegaClean HAP-04 Assembly Projectile (100 ea)	7467-50015	MC-HAP-04
MegaClean HP-04 Hose Projectile (100 ea)	7467-50025	MC-HP-04
MegaClean HAP-06 Assembly Projectile (100 ea)	7467-50035	MC-HAP-06
MegaClean HP-06 Hose Projectile (100 ea)	7467-50045	MC-HP-06
MegaClean HAP-08 Assembly Projectile (100 ea)	7467-50055	MC-HAP-08
MegaClean HP-08 Hose Projectile (100 ea)	7467-50065	MC-HP-08
MegaClean HP-08-1 Hose Projectile (50 ea)	7467-50075	MC-HP-08-1
MegaClean HP-10 Hose Projectile (50 ea)	7467-50085	MC-HP-10
MegaClean HP-10-1 Hose Projectile (50 ea)	7467-50095	MC-HP-10-1
MegaClean HP-12 Hose Projectile (50 ea)	7467-50105	MC-HP-12
MegaClean HP-12-1 Hose Projectile (40 ea)	7467-50115	MC-HP-12-1
MegaClean HP-14 Hose Projectile (40 ea)	7467-50125	MC-HP-14
MegaClean HP-16 Hose Projectile (40 ea)	7467-50135	MC-HP-16
MegaClean HP-16-1 Hose Projectile (30 ea)	7467-50145	MC-HP-16-1
MegaClean HP-20 Hose Projectile (30 ea)	7467-50155	MC-HP-20
MegaClean HP-20-1 Hose Projectile (20 ea)	7467-50165	MC-HP-20-1
MegaClean HP-24 Hose Projectile (20 ea)	7467-50175	MC-HP-24
MegaClean HP-24-1 Hose Projectile (15 ea)	7467-50185	MC-HP-24-1
MegaClean HP-32 Hose Projectile (15 ea)	7467-50195	MC-HP-32
MegaClean HP-32-1 Hose Projectile (10 ea)	7467-50205	MC-HP-32-1
MegaClean HP-40 Hose Projectile (10 ea)	7467-50215	MC-HP-40
MegaClean HP-48 Hose Projectile (10 ea)	7467-50225	MC-HP-48
MegaClean HP-56 Hose Projectile (10 ea)	7467-50235	MC-HP-56
MegaClean HP-64 Hose Projectile (10 ea)	7467-50245	MC-HP-64

Description – Bulk Pack	Product Number	Part Number
MegaClean HAPB-04-1 Assembly Projectile Bulk (10000 ea)	7467-5000	MC-HAPB-04-1
MegaClean HAPB-04 Assembly Projectile Bulk (10000 ea)	7467-5001	MC-HAPB-04
MegaClean HPB-04 Assembly Projectile Bulk (10000 ea)	7467-5002	MC-HPB-04
MegaClean HAPB-06 Assembly Projectile Bulk (10000 ea)	7467-5003	MC-HAPB-06
MegaClean HPB-06 Hose Projectile Bulk (10000 ea)	7467-5004	MC-HPB-06
MegaClean HAPB-08 Assembly Projectile Bulk (10000 ea)	7467-5005	MC-HAPB-08
MegaClean HPB-08 Hose Projectile Bulk (10000 ea)	7467-5006	MC-HPB-08
MegaClean HPB-08-1 Hose Projectile Bulk (9000 ea)	7467-5007	MC-HPB-08-1
MegaClean HPB-10 Hose Projectile Bulk (7000 ea)	7467-5008	MC-HPB-10
MegaClean HPB-10-1 Hose Projectile Bulk (5500 ea)	7467-5009	MC-HPB-10-1
MegaClean HPB-12 Hose Projectile Bulk (4000 ea)	7467-5010	MC-HPB-12
MegaClean HPB-12-1 Hose Projectile Bulk (3800 ea)	7467-5011	MC-HPB-12-1
MegaClean HPB-14 Hose Projectile Bulk (3500 ea)	7467-5012	MC-HPB-14
MegaClean HPB-16 Hose Projectile Bulk (2000 ea)	7467-5013	MC-HPB-16
MegaClean HPB-16-1 Hose Projectile Bulk (1900 ea)	7467-5014	MC-HPB-16-1
MegaClean HPB-20 Hose Projectile Bulk (1500 ea)	7467-5015	MC-HPB-20
MegaClean HPB-20-1 Hose Projectile Bulk (1200 ea)	7467-5016	MC-HPB-20-1
MegaClean HPB-24 Hose Projectile Bulk (650 ea)	7467-5017	MC-HPB-24
MegaClean HPB-24-1 Hose Projectile Bulk (600 ea)	7467-5018	MC-HPB-24-1
MegaClean HPB-32 Hose Projectile Bulk (450 ea)	7467-5019	MC-HPB-32
MegaClean HPB-32-1 Hose Projectile Bulk (360 ea)	7467-5020	MC-HPB-32-1



Step 3



Step 4



Step 5



Step 6

EQUIPMENT
HOSE/CPLG. SELECTION
G8K COUPLINGS
GLOBAL SPIRAL COUPLINGS
STAINLESS STEEL SPIRAL
MEGACRIMP COUPLINGS
STAINLESS STEEL BRAID
POWER CRIMP COUPLINGS
FIELD ATTACHABLE G1 & G2 COUPLINGS
FIELD ATTACHABLE C5 COUPLINGS
C14 COUPLINGS
GL COUPLINGS
GLX COUPLINGS
PCTS THERMOPLASTIC COUPLINGS
POLARSEAL COUPLINGS (ACA)
POLARSEAL II COUPLINGS (ACC)
POLARSEAL II COUPLINGS (ACB)
POWER STEERING
ADAPTERS
QUICK DISCONNECT COUPLERS
BALL VALVES
LIVE SWIVEL
ASSEMBLY FABRICATION
ACCESSORIES
EQUIPMENT AND PARTS
KITS
AIR BRAKE HOSE ASSY
BRASS

## Gates Bend-N-Fit™ Tube Bender

**Part Number:** 91025

**Product Number:** 7468-1040



Simply and easily duplicates bent tubes:

- Power Steering
- Air Conditioning
- Transmission Oil Cooler
- Fuel Lines
- Plus many more applications
- See assembly fabrication section for details

Bends SAE tubing as well as metric tubing – without changing any tooling – in the following sizes:

1/4" 5/16" 3/8" 1/2" 6mm-13mm

### Easy One-handed Operation

- Load tubing by pushing in on Tubing Lock Release.
- Pull down on Tubing Lock.
- Load tubing into proper size bending slot.
- Close Tubing Lock until it snaps into place. (Tubing Lock must snap for the tube to be firmly supported and for the tube to bend properly.)
- Close the tube support slide onto the tube.

Top of bender is segmented into 7 1/2° marks. This aids in precision bends. Original tube can be used as a pattern by measuring bends or by holding old tube above bender.

**IMPORTANT:** Be sure the mark on the tube support slide lines up with the zero on the top of the bender. Not lining up with zero will cause notching or creasing of the tube.

- Push handle sliding Tube Support Slide across tube to make your bend.
- Once you've made your first bend, rotate handle out of your way.
- Push in on Tubing Lock Release.
- Pull down on Tubing Lock.
- Remove tubing and reorient for next bend.
- Both the Tube Slide and Tube Lock move completely out of the way. This allows for bends in multiple planes.



**Tubing Lock**

**Tubing Lock Release**



EQUIPMENT
HOSE/CPLG. SELECTION
G8K COUPLINGS
GLOBAL SPIRAL COUPLINGS
STAINLESS STEEL SPIRAL
MEGACRIMP COUPLINGS
STAINLESS STEEL BRAID
POWER CRIMP COUPLINGS
FIELD ATTACHABLE G1 & G2 COUPLINGS
FIELD ATTACHABLE C5 COUPLINGS
C14 COUPLINGS
GL COUPLINGS
GLX COUPLINGS
PCTS THERMOPLASTIC COUPLINGS
POLARSEAL COUPLINGS (ACA)
POLARSEAL II COUPLINGS (ACC)
POLARSEAL II COUPLINGS (ACB)
POWER STEERING
ADAPTERS
QUICK DISCONNECT COUPLERS
BALL VALVES
LIVE SWIVEL
ASSEMBLY FABRICATION
ACCESSORIES
EQUIPMENT AND PARTS
KITS
AIR BRAKE HOSE ASSY
BRASS





# SEVEN EASY STEPS FOR SELECTING THE PROPER HOSE

An effective way to remember hose selection criteria is to remember the word...

## STAMPED

- S** = Size
- T** = Temperature
- A** = Application
- M** = Material to be conveyed
- P** = Pressure
- E** = Ends or couplings
- D** = Delivery (volume and velocity)

### 1. Hose Size (Dash Numbers)

The inside diameter of the hose must be adequate to keep pressure loss to a minimum and avoid damage to the hose due to heat generation or excessive turbulence. See hose sizing Nomographic Chart.

To determine the replacement hose size, read the layline printed on the side of the original hose. If the original hose layline is painted over or worn off, the original hose must be cut and the inside diameter measured for size.

**NOTE: Before cutting an original hose assembly, measure the overall assembly length and fitting orientation. These measurements will be required to build the replacement assembly.**

The hydraulics industry has adopted a measuring system called Dash Numbers to indicate hose and coupling size. The number which precedes the hose or coupling description is the dash size (see table). This industry standard number denotes hose I.D. in sixteenths of an inch. (The exception to this is the SAE100R5 hose C5CXH, C5C, C5D, C5E, C5M as well as, C14 and AC134a, where dash sizes denote hose I.D. equal to equivalent tube O.D.) See chart to the right. Hose O.D. can be a critical factor when hose routing clamps are used or hose are routed through bulkheads. Check individual hose specification tables for O.D.'s.

Dash No.	Hose I.D.			
	All Except C5 Series, C14 and PolarSeal (true bore)		C5 Series, C14 and PolarSeal (tube bore)	
	Inches	Millimeters	Inches	Millimeters
-2	1/8	3.2	-	-
-3	3/16	4.8	-	-
-4	1/4	6.4	3/16	4.8
-5	5/16	7.9	1/4	6.4
-6	3/8	9.5	5/16	7.9
-8	1/2	12.7	13/32	10.3
-10	5/8	15.9	1/2	12.7
-12	3/4	19.0	5/8	15.9
-14	7/8	22.2	-	-
-16	1	25.4	7/8	22.2
-20	1-1/4	31.8	1-1/8	28.6
-24	1-1/2	38.1	1-3/8	34.9
-28	1-3/4	44.5	-	-
-32	2	50.8	1-13/16	46.0
-36	2-1/4	57.6	-	-
-40	2-1/2	63.5	2-3/8	60.3
-48	3	76.2	-	-
-56	3-1/2	88.9	-	-
-64	4	101.6	-	-
-72	4-1/2	115.2	-	-

EQUIPMENT
HOSE/CPLG. SELECTION
G8K COUPLINGS
GLOBALSPIRAL COUPLINGS
STAINLESS STEEL SPIRAL
MEGACRIMP COUPLINGS
STAINLESS STEEL BRAID
POWER CRIMP COUPLINGS
FIELD ATTACHABLE G1 & G2 COUPLINGS
FIELD ATTACHABLE C5 COUPLINGS
C14 COUPLINGS
GL COUPLINGS
GLX COUPLINGS
PCTS THERMOPLASTIC COUPLINGS
POLARSEAL COUPLINGS (ACA)
POLARSEAL II COUPLINGS (ACC)
POLARSEAL II COUPLINGS (ACB)
POWER STEERING
ADAPTERS
QUICK DISCONNECT COUPLERS
BALL VALVES
LIVE SWIVEL
ASSEMBLY FABRICATION
ACCESSORIES
EQUIPMENT AND PARTS
KITS
AIR BRAKE HOSE ASSY
BRASS





EQUIPMENT
<b>HOSE/CPLG. SELECTION</b>
G8K COUPLINGS
GLOBAL SPIRAL COUPLINGS
STAINLESS STEEL SPIRAL
MEGACRIMP COUPLINGS
STAINLESS STEEL BRAID
POWER CRIMP COUPLINGS
FIELD ATTACHABLE G1 & G2 COUPLINGS
FIELD ATTACHABLE C5 COUPLINGS
C14 COUPLINGS
GL COUPLINGS
GLX COUPLINGS
PCTS THERMOPLASTIC COUPLINGS
POLARSEAL COUPLINGS (ACA)
POLARSEAL II COUPLINGS (ACC)
POLARSEAL II COUPLINGS (ACB)
POWER STEERING
ADAPTERS
QUICK DISCONNECT COUPLERS
BALL VALVES
LIVE SWIVEL
ASSEMBLY FABRICATION
ACCESSORIES
EQUIPMENT AND PARTS
KITS
AIR BRAKE HOSE ASSY
BRASS

## 2. Temperature

When selecting a replacement assembly, two areas of temperature must be considered. These are fluid temperature and ambient temperature. The hose selected must be capable of withstanding the minimum and maximum temperature seen by the system. Care must be taken when routing near hot manifolds and in extreme cases a heat shield may be advisable. See the Gates Hydraulic Hose Selection Guide; Hose Specification Pages; and/or the Additional Temperature Limits for Gates Hydraulic Hose Chart for temperature ranges and limits for water, water/oil emulsions and water/glycol solutions.

## 3. Application

Determine where or how the replacement hose or assembly is to be used. Most often only a duplicate of the original hose will have to be made. To fulfill the requirements of the application, additional questions may need to be answered, such as:

- Where Will Hose be Used?
- Fluid and/or Ambient Temperature?
- Hose Construction?
- Equipment Type?
- Fluid Compatibility?
- Thread End Connection Type?
- Working and Surge Pressures?
- Environmental Conditions?
- Permanent or Field Attachable Couplings?
- Suction Application?
- Routing Requirements?
- Thread Type?
- Government and Industry Standards Being Met?
- Unusual Mechanical Loads?
- Minimum Bend Radius?
- Non-Conductive Hose Required?
- Excessive Abrasion?

## 4. Material to be Conveyed

Some applications require specialized oils or chemicals to be conveyed through the system. Hose selection must ensure compatibility of the hose tube, cover, couplings and o-rings with the fluid used. Additional caution must be exercised in hose selection for gaseous applications such as refrigerants and LPG.

**NOTE: All block type couplings contain nitrile o-rings (unless otherwise noted) which must be compatible with the fluids being used.**

## 5. Pressure

Most important in the hose selection process is knowing system pressure, including pressure spikes. Published working pressures must be equal to or greater than the system pressure. Pressure spikes greater than the published working pressure will shorten hose life and must be taken into consideration. Gates **DOES NOT** recommend using hose on applications having pressure spikes greater than published working pressures of the hose.

## 6. Ends of Couplings

Identify end connections using Gates coupling templates and measuring tools or Coupling Identification section. Once thread ends have been identified, consult the appropriate section of the catalog for specific part number selection.

## 7. Delivery (Volume and Velocity)

If the same I.D. of the original hose is used, assume the system is properly sized to efficiently transport fluid. If the system is new or altered, determine the hose I.D. needed to transport required fluid volume flow by using the Nomographic Chart.



## CHARACTERISTICS OF HOSE STOCK TYPES

The characteristics shown below are for the normal or usual range of these specific stocks. Stocks can be changed somewhat through different compounding to meet the requirements of specialized applications.

Tube and cover stocks may occasionally be upgraded to take advantage of improved materials and technology.

For detailed information on a specific hose tube or cover stock, check the Chemical Resistance Table and also the specific hose page.

	Polychloroprene	Nitrile	Nylon	CSM	EPDM	CPE	PTFE
Flame Resistance	Very Good	Poor	Good	Good	Poor	Good	Good
Petroleum Base Oils	Good	Excellent	Good to Excellent	Good	Poor	Very Good	Excellent
Diesel Fuel	Fair to Good	Good to Excellent	Good to Excellent	Good	Poor	Good	Excellent
Resistance to Gas Permeation	Good	Good	Good To Excellent	Good to Excellent	Fair to Good	Good	Good to Excellent
Weather	Good to Excellent	Poor	Excellent	Very Good	Excellent	Good	Excellent
Ozone	Good to Excellent	Poor for Tube; Good For Cover	Excellent	Very Good	Outstanding	Good	Excellent
Heat	Good	Good	Good	Very Good	Excellent	Excellent	Excellent
Low Temperature	Fair to Good	Poor to Fair	Excellent	Poor	Good to Excellent	Good	Excellent
Water-Oil Emulsions	Excellent	Excellent	Good to Excellent	Good	Poor	Excellent	Excellent
Water/Glycol Emulsions	Excellent	Excellent	Excellent	Excellent	Excellent	Excellent	Excellent
Diesters	Poor	Poor	Excellent	Fair	Excellent	Very Good	Excellent
Phosphate Esters	Fair (For Cover)	Poor	Excellent	Fair	Very Good	Very Good	Excellent
Phosphate Ester Base Emulsions	Fair (For Cover)	Poor	Excellent	Fair	Very Good	Very Good	Excellent

## COVER ABRASION RESISTANCE

These comparisons are based on test results per ISO 6945 abrasion testing. The table shows the expected number of times of extended cover service life as compared to a standard cover.

	Modified Nitrile (Standard cover)	Nylon Sleeve	XtraTuff®	MegaTuff®
Relative Abrasion Resistance	1	15 X Standard Cover	25 X Standard Cover	300 X Standard Cover

EQUIPMENT
HOSE/CPLG. SELECTION
G8K COUPLINGS
GLOBAL SPIRAL COUPLINGS
STAINLESS STEEL SPIRAL
MEGACRIMP COUPLINGS
STAINLESS STEEL BRAID
POWER CRIMP COUPLINGS
FIELD ATTACHABLE G1 & G2 COUPLINGS
FIELD ATTACHABLE C5 COUPLINGS
C14 COUPLINGS
GL COUPLINGS
GLX COUPLINGS
PCTS THERMOPLASTIC COUPLINGS
POLARSEAL COUPLINGS (ACA)
POLARSEAL II COUPLINGS (ACC)
POLARSEAL II COUPLINGS (ACB)
POWER STEERING
ADAPTERS
QUICK DISCONNECT COUPLERS
BALL VALVES
LIVE SWIVEL
ASSEMBLY FABRICATION
ACCESSORIES
EQUIPMENT AND PARTS
KITS
AIR BRAKE HOSE ASSY
BRASS

# GATES HYDRAULIC HOSE SELECTION GUIDE



EQUIPMENT	Standard Industry Specification	Gates Description	Construction (Reinforcement)	Use	Stock		
					Tube Name	Cover Name	
HOSE/CP/LG. SELECTION	Gates Proprietary Design	G8K	6-spiral, wire	Ultra High Pressure & Impulse Cycle Life, High Temperature, Petroleum Oils	Polychloroprene	Polychloroprene	
	ISO 3862 R15 SAE 100R15 EN 856 4SP/4SH	EFG6K	4 & 6-spiral, wire	Extremely High Pressure & Impulse Cycle Life, High Temperature, Petroleum Oils, Environmental Fluids	Nitrile	Polychloroprene	
G8K COUPLINGS		EFG6K-MTF	4 & 6-spiral, wire	Extremely High Abrasion Resistant, Pressure & Impulse Cycle Life, High Temperature, Petroleum Oils, Environmental Fluids	Nitrile	MegaTuff	
GLOBAL SPIRAL COUPLINGS	ISO 18752 Grade D ISO 3862 R13 SAE 100R13 EN 856 4SH/4SP EN 856 R13	EFG5K	4 & 6-spiral, wire	Extremely High Pressure & Impulse Cycle Life, High Temperature, Petroleum Oils, Environmental Fluids	Nitrile	Polychloroprene	
		EFG5K-MTF	4 & 6-spiral, wire	Extremely High Abrasion Resistant, Pressure & Impulse Cycle Life, High Temperature, Petroleum Oils, Environmental Fluids	Nitrile	MegaTuff	
STAINLESS STEEL SPIRAL							
MEGACRIMP COUPLINGS	ISO 18752 SAE J517 100R13	ID5K	4-spiral, wire	Extremely High-Pressure, High-Impulse Applications	HNBR	Polychloroprene	
STAINLESS STEEL BRAID	ISO 18752 Grade D ISO 3862 R12 SAE 100R12 EN 856 R12	EFG4K	4-spiral, wire	Very High Pressure & Impulse Cycle Life, High Temperature, Petroleum Oils, Environmental Fluids	Nitrile	Polychloroprene	
		EFG4K-MTF	4-spiral, wire	Extremely High Abrasion Resistant, Very High Pressure & Impulse Cycle Life, High Temperature, Petroleum Oils, Environmental Fluids	Nitrile	MegaTuff	
		EFG4K-XTF	4-spiral, wire	High Abrasion Resistant, Pressure & Impulse Cycle Life, High Temperature, Petroleum Oils, Environmental Fluids	Nitrile	XtraTuff Nitrile	
POWER CRIMP COUPLINGS	ISO 18752 Grade D ISO 3862 R12 SAE 100R12 EN 856 4SP EN 856 R12	EFG3K	4-spiral, wire	Very High Pressure & Impulse Cycle Life, High Temperature, Petroleum Oils, Environmental Fluids	Nitrile	Polychloroprene	
		EFG3K-MTF	4-spiral, wire	Extremely High Abrasion Resistant, Very High Pressure & Impulse Cycle Life, High Temperature, Petroleum Oils, Environmental Fluids	Nitrile	MegaTuff	
FIELD ATTACHABLE G1 & G2 COUPLINGS	Gates Proprietary Design	M6K	2-braid, wire	High Pressure, Impulse Cycle Life & Flexibility, Tight Bend Radius, Petroleum Oils, Environmental Fluids	Nitrile	Nitrile + PVC	
FIELD ATTACHABLE C5 COUPLINGS	Gates Proprietary Design ISO 18752 Grade B	M5K	2-braid, wire	High Pressure, Impulse Cycle Life & Flexibility, Tight Bend Radius, Petroleum Oils, Environmental Fluids	Nitrile	Nitrile + PVC and Polychloroprene	
		M5K-MTF	2-braid, wire	Extremely High Abrasion Resistant, High Pressure, Impulse Cycle Life & Flexibility, Tight Bend Radius, Petroleum Oils, Environmental Fluids	Nitrile	MegaTuff	
		M5K-XTF	2-braid, wire	High Abrasion Resistant, Pressure, Impulse Cycle Life & Flexibility, Tight Bend Radius, Petroleum Oils, Environmental Fluids	Nitrile	XtraTuff Nitrile	
C14 COUPLINGS							
GL COUPLINGS	ISO 18752 Grade B ISO 11237 R19 SAE 100R19	M4K	2-braid, wire	High Pressure, Impulse Cycle Life & Flexibility, Tight Bend Radius, Petroleum Oils, Environmental Fluids	Nitrile	Nitrile + PVC	
GLX COUPLINGS		M4K-MTF	2-braid, wire	Extremely High Abrasion Resistant, High Pressure, Impulse Cycle Life & Flexibility, Tight Bend Radius, Petroleum Oils, Environmental Fluids	Nitrile	MegaTuff	
		M4K-XTF	2-braid, wire	High Abrasion Resistant, Pressure, Impulse Cycle Life & Flexibility, Tight Bend Radius, Petroleum Oils, Environmental Fluids	Nitrile	XtraTuff Nitrile	
PCTS THERMOPLASTIC COUPLINGS	ISO 18752 Grade C ISO 11237 R19 SAE 100R19	M4KH	2-braid, wire	High Temperature, Pressure, Impulse Cycle Life & Flexibility, Tight Bend Radius, Petroleum Oils, Environmental Fluids	Nitrile	Polychloroprene	
		M4KH-MTF	2-braid, wire	Extremely High Abrasion Resistant, High Temperature, Pressure, Impulse Cycle Life & Flexibility, Tight Bend Radius, Petroleum Oils, Environmental Fluids	Nitrile	MegaTuff	
POLARSEAL COUPLINGS (ACA)	ISO 18752 Grade B ISO 11237 R17 SAE 100R17 EN 857 1SC	M3K	1 & 2-braid, wire	High Pressure, Impulse Cycle Life & Flexibility, Tight Bend Radius, Petroleum Oils, Environmental Fluids	Nitrile	Nitrile + PVC	
		M3K-MTF	1 & 2-braid, wire	Extremely High Abrasion Resistant, High Pressure, Impulse Cycle Life & Flexibility, Tight Bend Radius, Petroleum Oils, Environmental Fluids	Nitrile	MegaTuff	
		M3K-XTF	1 & 2-braid, wire	High Abrasion Resistant, Pressure, Impulse Cycle Life & Flexibility, Tight Bend Radius, Petroleum Oils, Environmental Fluids	Nitrile	XtraTuff Nitrile	
POLARSEAL II COUPLINGS (ACC)	ISO 18752 Grade C ISO 11237 R17 SAE 100R17 EN 857 1SC	M3KH	1 & 2-braid, wire	High Temperature, Pressure, Impulse Cycle Life & Flexibility, Tight Bend Radius, Petroleum Oils, Environmental Fluids	Nitrile	Polychloroprene	
		M3KH-MTF	1 & 2-braid, wire	Extremely High Abrasion Resistant, High Temperature, Pressure, Impulse Cycle Life & Flexibility, Tight Bend Radius, Petroleum Oils, Environmental Fluids	Nitrile	MegaTuff	
POLARSEAL II COUPLINGS (ACB)	SAE 100R16 SAE 100R2 Performance	MXT	High-tensile steel wire braid	High Pressure, Impulse Cycle Life & Flexibility, Tight Bend Radius, Petroleum Oils, Environmental Fluids	Nitrile	Nitrile + PVC	
POWER STEERING	ISO 11237 2SC R16 ISO 1436 2SN R2 EN 857 2SC EN 853 2SN SAE 100R16 SAE 100R2	M2T®	2-braid, wire	High Pressure, Impulse Cycle Life & Flexibility, Tight Bend Radius, Petroleum Oils, Environmental Fluids	Nitrile	Nitrile + PVC	
		M2T®-MTF	2-braid, wire	Ultra High Abrasion Resistant, High Pressure, Impulse Cycle Life & Flexibility, Tight Bend Radius, Petroleum Oils, Environmental Fluids	Nitrile	MegaTuff	
		M2T®-XTF	2-braid, wire	High Abrasion Resistant, Pressure, Impulse Cycle Life & Flexibility, Tight Bend Radius, Petroleum Oils, Environmental Fluids	Nitrile	XtraTuff Nitrile	
ADAPTERS							
QUICK DISCONNECT COUPLERS	Exceeds ISO/DIS 1436 SAE 100R16 EN 857 2SC	CM2TDL-XTF	2-braid, wire	High Pressure, Impulse Cycle Life & Flexibility, Tight Bend Radius, Petroleum Oils, Environmental Fluids	Nitrile	XtraTuff Nitrile	
BALL VALVES	ISO 1436 2SN R2 SAE 100R2 Type AT EN 853 2SN	G2	2-braid, wire	High Pressure, Petroleum Oils & Environmental Fluids	Nitrile	Nitrile + PVC	
		G2L	2-braid, wire	High Pressure, Low Temperature, Petroleum Oils & Environmental Fluids	Nitrile	Polychloroprene	
		G2XH	2-braid, wire	Extremely High Heat, High Pressure, Petroleum Oils & Environmental Fluids	CPE	CSM	
LIVE SWIVEL	ISO 1436 2SN R2 SAE 100R2 Type AT EN 853 2SN	G2H	2-braid, wire	High Pressure, Temperature, Petroleum Oils & Environmental Fluids	Nitrile	CSM	
		G2H-MTF	2-braid, wire	High Pressure, Temperature, Petroleum Oils & Environmental Fluids	Nitrile	MegaTuff	
ASSEMBLY FABRICATION	Gates Proprietary Design	M-XP	2-braid, wire	High Pressure & Impulse Cycle Life, High Flexibility, Tight Bend Radius, Petroleum Oils, Environmental Fluids	Nitrile	Nitrile + PVC and Polychloroprene	
		J100	J2AT	2-braid, wire	Industrial Jack Hose Applications	Nitrile	Nitrile + PVC
		J100	J2AT-MTF	2-braid, wire	Ultra High Abrasive Industrial Jack Hose Applications	Nitrile	MegaTuff
ACCESSORIES							
EQUIPMENT AND PARTS	ISO 1436 1SN R1 SAE 100R1 Type AT EN 853 1SN	G1	1-braid, wire	Medium Pressure, Petroleum Oils & Environmental Fluids	Nitrile	Nitrile + PVC	
		SAE 100R1 Type AT	G1H	1-braid, wire	High Temperature, Medium Pressure, Petroleum Oils & Environmental Fluids	Nitrile	CSM
KITS	Gates Proprietary Design SAE 100R1	RFS	1-braid, wire	Low Pressure, Powder Fire Suppressant Applications	Nitrile	Nitrile + PVC	
AIR BRAKE HOSE ASSY							
BRASS							



# GATES HYDRAULIC HOSE SELECTION GUIDE - CONTINUED

Standard Industry Specification	Gates Description	Construction (Reinforcement)	Use	Stock	
				Tube Name	Cover Name
SAE 100R3	G3H	2-braid, textile	Petroleum Oils, Antifreeze, Water, High Temperature	Nitrile	Polychloroprene
SAE 100R6	GTH	1-braid, textile	Petroleum Oils, Antifreeze, Water, High Temperature	Nitrile	Polychloroprene
SAE 100R6	GTHX	1-spiral, textile	Petroleum Oils, Antifreeze, Water, High Temperature	Nitrile	Polychloroprene
Gates Proprietary Design	M500	1-braid, wire, textile	Pilot Lines, Grease Lines and Pressure Return Lines, 500 psi or Less Pressure Applications	Nitrile	Nitrile + PVC
SAE 100R4	Multi Master	High tensile textile, helical wire	Return & Suction High Temperature	Nitrile	Polychloroprene
SAE 100R4	GMV	2-spiral, textile, helical wire	Return & Suction High Temperature	Nitrile	Polychloroprene
SAE 100R4	G4H	2-spiral, textile, helical wire	Return & Suction High Temperature	Nitrile	Polychloroprene
SAE 30R2 Type 1 & 2, B20 Biodiesel	RLA	1-braid, textile	Return & Suction Low Pressure, Biodiesel up to 125°F	Nitrile	Nitrile + PVC
Gates Proprietary Design	RLC	3-braid, textile	Return & Low Pressure	Nitrile	Nitrile + PVC
Gates Proprietary Design	MegaTech® LOC	1-braid, textile	Extremely High Heat, Hot Oil Pressure & Return Lines, High Temperature Rotary Oil/Air, Air Compressor, Petroleum Oils, Transmission Oil Cooler	CPE	Textile
SAE 30R2, 30R6, 30R7 and B20 Biodiesel	LOC	1-braid, textile	Petroleum, Oils, Antifreeze, Water, Air & Biodiesel up to 125°F	Nitrile	Textile
Gates Proprietary Design	L0L	1-braid, textile	Petroleum Oils, Antifreeze, Water & Air	Nitrile	Nitrile + PVC and Polychloroprene (L0LA)
SAE J1402, DOT** FMVSS 106-74	TR500	1-braid wire, textile	Petroleum & Synthetic Fluids, Air Brakes	Nitrile	Textile
Gates Proprietary Design	MegaTech® G5TB	2-braid, wire, textile	Extremely High Heat, Hot Oil Pressure & Return Lines, High Temperature Rotary Oil/Air, Air Compressor, Petroleum Oils	CPE	Textile
SAE 100R2 Type AT SAE 100R2 Type AT	MegaTech® II	2-braid, wire, textile	Extremely High Heat, Hot Oil Pressure & Return Lines, High Temperature Rotary Oil/Air, Air Compressor, Petroleum Oils	CPE	Textile
Gates Proprietary Design	MegaTech® 3000	2-braid, wire, textile	Pressurized Hot Oil Return Lines and Rotary Oil Lines	CPE	Textile
SAE J1402 DOT FMVSS 106-74	MegaTech® 1000	1-braid, wire, textile	Extremely High Heat, Hot Oil Pressure & Return Lines, High Temperature Rotary Oil/Air, Air Compressor, Petroleum Oils, Air Brake	CPE	Textile
Gates Proprietary Design	MegaTech® 500	1-braid, wire, textile	Extremely High Heat, Hot Oil Pressure & Return Lines, High Temperature Rotary Oil/Air, Air Compressor, Petroleum Oils	CPE	Textile
Gates Proprietary Design	MegaTech® 250	1-braid, wire, textile	Extremely High Heat, Hot Oil Pressure & Return Lines, High Temperature Rotary Oil/Air, Air Compressor, Petroleum Oils, Transmission Oil Cooler	CPE	Textile
SAE 100R5, SAE J1402 DOT FMVSS 106-74 Type All	*C5C	3-braid, T-W-T	Petroleum Oil, Air Brake, Power Steering	Nitrile	Textile
SAE 100R5, SAE J1402 DOT FMVSS 106-74 Type All	C5C-XH	1-braid, wire, textile	Extremely High-Temperature Petroleum-Based or Phosphate Ester Fluids	CPE	Textile
SAE J1402, DOT FMVSS 106-74 Type All	C5D	3-braid, T-W-T	Petroleum & Synthetic Fluids, Air Brakes	CPE	Textile
SAE J1527, SAE J1942 ISO 840-A1	C5M	1-braid, textile	Marine Fuel & Oil	Nitrile	Nitrile + PVC
SAE J1402, DOT FMVSS 106-74 Type A1	C5E	3-braid, T-W-T	Air Brake, Power Steering, Lube	Nitrile	Textile
<b>PTFE</b>					
SAE 100R14	C14	1-braid, stainless steel	High Temperature, Multi Fluid, Non-Conductive	PTFE	Stainless Steel
SAE 100R14	C14CT	1-braid, stainless steel	High Temperature, Multi Fluid, Conductive	PTFE	Stainless Steel
<b>Thermoplastic</b>					
SAE 100R7	TH7	1-braid, polyester	Petroleum & Synthetic Fluids	Nylon	Urethane
SAE 100R7	TH7NC	1-braid, polyester	Non-Conductive	Nylon	Urethane
SAE 100R7	TH7DL	1-braid, polyester	Petroleum & Synthetic Fluids, Dual Line	Nylon	Urethane
SAE 100R7	TH7NCDL	1-braid, polyester	Non-Conductive, Dual Line	Nylon	Urethane
SAE 100R7	TH7S	Synthetic fiber	Petroleum & Synthetic Fluids	Polyester	Urethane
SAE 100R7	TH7SNC	Synthetic fiber	Non-Conductive	Polyester	Urethane
SAE 100R8	TH8	2-braid, polyester	Petroleum & Synthetic Fluids	Nylon	Urethane
SAE 100R8	TH8NC	2-braid, polyester	Non-Conductive	Nylon	Urethane
SAE 100R18	TH18	1-braid, synthetic fiber	Petroleum & Synthetic Fluids	Nylon	Urethane
SAE 100R18	TH18NC	2-braid, synthetic fiber	Non-Conductive	Nylon	Urethane
<b>Refrigerant</b>					
SAE J51 Type A2 Dimensions/Type D Performance, SAE J2064 and J3062 Type C, Class II Performance	PolarSeal® AC134a	Nylon barrier, 2-spiral, polyester	Air Conditioning (R12 and R134a)	Polychloroprene	EPDM
SAE J2064, SAE J3062 Type C, Class 1	PolarSeal® ACC-PSII	Single-braid polyester	Reduced Barrier Construction, Air Conditioning (R12, R13A and R22)	Elastomeric	Elastomeric

\* -4 and -5 sizes have a Polychloroprene tube, \*\*MegaTech1000 sizes -4, 6, -8, -10

- EQUIPMENT
- HOSE/CPLG. SELECTION
- G8K COUPLINGS
- GLOBAL SPIRAL COUPLINGS
- STAINLESS STEEL SPIRAL
- MEGACRIMP COUPLINGS
- STAINLESS STEEL BRAID
- POWER CRIMP COUPLINGS
- FIELD ATTACHABLE G1 & G2 COUPLINGS
- FIELD ATTACHABLE C5 COUPLINGS
- C14 COUPLINGS
- GL COUPLINGS
- GLX COUPLINGS
- PCTS THERMOPLASTIC COUPLINGS
- POLARSEAL COUPLINGS (ACA)
- POLARSEAL II COUPLINGS (ACC)
- POLARSEAL II COUPLINGS (ACB)
- POWER STEERING
- ADAPTERS
- QUICK DISCONNECT COUPLERS
- BALL VALVES
- LIVE SWIVEL
- ASSEMBLY FABRICATION
- ACCESSORIES
- EQUIPMENT AND PARTS
- KITS
- AIR BRAKE HOSE ASSY
- BRASS

# GATES HYDRAULIC HOSE SELECTION GUIDE - CONTINUED



EQUIPMENT	Description	Temp. Range (°F)	Dash Size vs. Rated Working Pressure (psi)																		
			-2	-3	-4	-5	-6	-8	-10	-12	-16	-20	-24	-28	-32	-36	-40	-48	-56	-64	-72
HOSE/CPLG. SELECTION	G8K	-40 +250								8,000	8,000										
	EFG6K	-40 +250					6,000	6,000	6,000	6,000	6,000	6,000									
	EFG6KL	-70 +212							6,000	6,000	6,000										
G8K COUPLINGS	EFG5K	-40 +250				5,000	5,000	5,000	5,000	5,000	5,000	5,000	5,000								
	EFG5KL	-70 +212				5,000	5,000	5,000	5,000	5,000	5,000	5,000	5,000								
	ID5K	-40 +250							5,000	5,000	5,000										
GLOBAL SPIRAL COUPLINGS	EFG4K	-40 +250				4,000	4,000	4,000	4,000	4,000	4,000	4,000									4,000
	EFG4KL	-70 +212							4,000	4,000	4,000										
	EFG3K	-40 +250										3,000	3,000								
STAINLESS STEEL SPIRAL	M6K	-40 +212			6,000																
MEGACRIMP COUPLINGS	M5K	-40 +212			5,000	5,000	5,000	5,000													
	M4K	-40 +212			4,000	4,000	4,000	4,000	4,000	4,000	4,000										
	M4KH	-40 +250			4,000	4,000	4,000	4,000	4,000	4,000	4,000										
	M4KL	-70 +212			4,000	4,000	4,000	4,000	4,000	4,000	4,000										
STAINLESS STEEL BRAID	M3K	-40 +212	3,250	3,250	3,250	3,250	3,250	3,250	3,250	3,250	3,250										
	M3KH	-40 +250		3,250	3,250	3,250	3,250	3,250	3,250	3,250	3,250										
POWER CRIMP COUPLINGS	M-XT	-40 +212				4,800	4,800	4,800	3,625	3,125	2,400										
	M-XP	-40 +212			4,000	4,000	4,000	4,000	4,000												
	M2T®	-40 +212			6,000	5,000	4,300	3,800	3,500	2,500	2,300	2,000									1,500
	CM2TDL	-40 +212				4,800	4,000														
FIELD ATTACHABLE G1 & G2 COUPLINGS	G2	-40 +212	6,025	5,800		4,800	4,000		3,625	3,100	2,400										
	G2H	-40 +275										1,825	1,300								1,175
	G2XH	-40 +300			6,000		5,000	4,250	3,625	3,100	2,500	2,250	1,800								1,500
	G2L	-70 +212			5,800		4,800	4,000	3,625	3,100	2,400	1,825	1,300								1,175
FIELD ATTACHABLE C5 COUPLINGS	G1	-40 +212	3,625	3,275	3,125	2,600	2,325	1,900	1,525	1,300	925	725									600
	G1H	-40 +275		2,750	2,000	2,250	2,000	1,500	1,250	1,000	925	725									600
C14 COUPLINGS	J2AT	-40 +120			10,000	10,000															
	Hot Oiler	-40 +300																			2,300
	RFS	-40 +212	3,000	2,750		2,250	2,000		1,250	1,000											
GL COUPLINGS	G3H	-40 +275			1,250	1,200	1,125	1,000	900	750	565	375	300								
	GTH	-40 +275	500	400	400		400	350	300	250											
	GTHX	-40 +275					400														
GLX COUPLINGS	M500	-40 +212			500	500	500	500	500	500	500										
	Multi Master	-40 +275							350	300	250	150									150
PCTS THERMOPLASTIC COUPLINGS	G4H	-40 +275							300	250	200										
	GMV	-40 +275							350	300	250	160									115
	RLA	-40 +212	250	250	250	250	200	200	200	160											
	RLC	-40 +275								200	200	200	200	200	150	150	150	150			100
POLARSEAL COUPLINGS (ACA)	LOC	-40 +250		300	300	300	300	300	300												
	LOL	-40 +212	300	300	300	300	300	300	300												
POLARSEAL II COUPLINGS (ACC)	TR500	-40 +250		500	500	500	500	500	500												
	MegaTech® II	-40 +300										2,250	1,500								1,300
	MegaTech® G5TB	-40 +300			3,000		3,000	3,000	2,000	2,000	1,000	1,000	500								500
	MegaTech® 3000	-40 +300			3,000		3,000	3,000													
	MegaTech® 1000	-40 +300			1,000		1,000	1,000	1,000	1,000	1,000										
POLARSEAL II COUPLINGS (ACB)	MegaTech® 500	-40 +300											500								500
	MegaTech® 250	-40 +300			250		250	250	250	250	250										
	MegaTech® LOC	-40 +300			300		300	300	300	300											
	C5C	-40 +212	3,000	3,000	2,250	2,000	1,750	1,500	800	625	500										350
POWER STEERING	C5C-XH	-40 +302	3,000	3,000	2,250	2,000	1,750	1,500	800	625											350
	C5D	-40 +300 *	1,500	1,500	1,500	1,250	1,250	750	400												
	C5M	-4 +212			500	500	500	500	500	500											
	C5E	-40 +300 *	1,500	1,500	1,500	1,250	1,250	750	400	300											
ADAPTERS	PolarSeal® AC134a	-22 +257				500	500	500	500												
	PolarSeal® ACC-PSII	-22 +257				350	350	350	350	350											
QUICK DISCONNECT COUPLERS	C14 (Dynamic)	-65 +400			1,500	1,500	1,500	1,000	800	800	800										
	C14 (Static)	-65 +450			3,000	3,000	2,500	2,000	1,500	1,200	1,000										
	C14CT (Dynamic)	-65 +400					1,500	1,000													
	C14CT (Static)	-65 +450					2,500	2,000													
BALL VALVES	TH7	-65 +200	3,000	3,000	2,750	2,500	2,250	2,000			1,250	1,000									
	TH7NC	-65 +200	3,000	3,000	2,750	2,500	2,250	2,000			1,250	1,000									
	TH7DL	-65 +200			2,750	2,500	2,250	2,000													
	TH7NCDL	-65 +200			2,750		2,250	2,000													
	TH7S	-65 +200			2,750	2,500	2,250	2,000													
	TH8	-65 +200		5,000	5,000		4,000	3,500			2,250	2,000									
	TH8NC	-65 +200			5,000		4,000	3,500													
	TH18	-67 +212			3,000	3,000	3,000	3,000	3,000												
ACCESSORIES	TH18NC	-67 +212			3,000	3,000	3,000	3,000	3,000												

\* All purpose fleet application service - 40°F to +300°F (-40°C to +149°C), air to +250°F



## ADDITIONAL TEMPERATURE LIMITS FOR GATES HYDRAULIC HOSE

**Caution:** Water, water/oil emulsions and water/glycol solutions must be kept below the temperatures listed in the table below, relative to line pressures.

### MAXIMUM TEMPERATURE LIMITS FOR WATER, WATER/OIL EMULSIONS AND WATER/GLYCOL SOLUTIONS

Hose	Pressure Lines	Return Lines
G8K, EFG6K, EFG5K, EFG4K, EFG3K, G2, G2L, M2T <sup>®</sup> , M6K, M5K, M4K, M3K, RFS, RLA, C5C, C5E, LOC, LOL	+200°F (+93°C)	+180°F (+82°C)
G2H, G1H, MegaTech <sup>®</sup> Line, G2XH, C5D, G3H, GTH, G4H, GMV, RLC, TR500, M3KH, M4KH	+225°F (+107°C)	+180°F (+82°C)

**Caution:** The fluid manufacturer's recommended maximum operating temperature for any given fluid must not be exceeded. If different than the above listed hose temperatures, the lower limit must take precedence. Actual service life at temperatures approaching the recommended limit will depend on the particular application and the fluid being used in the hose. Intermittent (up to 10 percent of operating time) refers to momentary temperature surges. Detrimental effects increase with increased exposure to elevated temperatures.

Do NOT expose hose to maximum temperature and maximum rated working pressure at the same time.

EQUIPMENT
HOSE/CPLG. SELECTION
G8K COUPLINGS
GLOBALSPIRAL COUPLINGS
STAINLESS STEEL SPIRAL
MEGACRIMP COUPLINGS
STAINLESS STEEL BRAID
POWER CRIMP COUPLINGS
FIELD ATTACHABLE G1 & G2 COUPLINGS
FIELD ATTACHABLE C5 COUPLINGS
C14 COUPLINGS
GL COUPLINGS
GLX COUPLINGS
PCTS THERMOPLASTIC COUPLINGS
POLARSEAL COUPLINGS (ACA)
POLARSEAL II COUPLINGS (ACC)
POLARSEAL II COUPLINGS (ACB)
POWER STEERING
ADAPTERS
QUICK DISCONNECT COUPLERS
BALL VALVES
LIVE SWIVEL
ASSEMBLY FABRICATION
ACCESSORIES
EQUIPMENT AND PARTS
KITS
AIR BRAKE HOSE ASSY
BRASS



TYPE APPROVAL AND HOSE SELECTION GUIDE



EQUIPMENT
HOSE/CPLG. SELECTION
G8K COUPLINGS
GLOBAL SPIRAL COUPLINGS
STAINLESS STEEL SPIRAL
MEGACRIMP COUPLINGS
STAINLESS STEEL BRAID
POWER CRIMP COUPLINGS
FIELD ATTACHABLE G1 & G2 COUPLINGS
FIELD ATTACHABLE C5 COUPLINGS
C14 COUPLINGS
GL COUPLINGS
GLX COUPLINGS
PCTS THERMOPLASTIC COUPLINGS
POLARSEAL COUPLINGS (ACA)
POLARSEAL II COUPLINGS (ACC)
POLARSEAL II COUPLINGS (ACB)
POWER STEERING ADAPTERS
QUICK DISCONNECT COUPLERS
BALL VALVES
LIVE SWIVEL
ASSEMBLY FABRICATION
ACCESSORIES
EQUIPMENT AND PARTS
KITS
AIR BRAKE HOSE ASSY
BRASS

Hose Types	DNV-GL			ABS			USCG			
	Sizes		Couplings	Sizes		Couplings	Sizes		Couplings	Type
	From	To		From	To		From	To		
EFG6K	-6	-32	GS / GSH / GSM	-6	-32	GS (6-20) GSM (24-32)	-6	-32	GS (6-20) GSM (24,32) S-SS (6, 8, 10)	HF (GS) H (GSM) H S-SS H GS (6,8) HF GS (10-20) HF GSM (24,32) H (S-SS)
EFG5K	-6	-32	GS / GSH / GSM	-10	-32	GS (6-20) GSM (24-32)	-6	-32	GS (6-20) GSM (24,32) S-SS (6, 8, 10)	HF GS (10-20) HF GSM (24,32) H (S-SS)
EFG4K	-6	-20	GS	-6	-16	GS	-6	-16	GS S-SS (6, 8, 10, 16)	HF (GS) H (S-SS)
EFG3K	-20	-32	GS / GSP	-20	-32	GS	-20	-20	GS	HF
M6K	-4	-4	G	-4	-4	G	-8	-8	B-SS	H
M5K	-4	-8	G	-4	-8	G	-4	-16	G (4-12) GS (6-16) B-SS (4, 8)	HF (G,GS) H (B-SS)
M4K	-4	-16	G & GS	-4	-12	G & GS	-4	-16	G B-SS (10, 12)	HF (G) F (B-SS)
M3K	-4	-16	G	-4	-16	G	-4	-16	G (4-16) B-SS (4-8, 12, 16)	HF
M2T	Expected Spring 2015			-4	-16	B-SS & G	-4	-16	G B-SS (4-8, 12, 16)	H
G2XH	Expected Spring 2015			-4	-32	G (4 - 20) GSP (24 - 32)	-4	-32	PC (3), B-SS (4) G (4-20) GSP (24,32)	H
G2	-4	-32	G (4 - 20) GSP (24 - 32)	-4	-32	G (4 - 20) GSP (24 - 32)	-4	-32	G PC (3)	H (4) HF (6,8,12,16)
G1H	Expected Spring 2015			-4	-32	G (4 - 20) GSP (24 - 32)	-4	-32	G (4 - 20) GSP (24,32)	H
G1	-4	-32	G (4 - 20) GSP (24 - 32)	-4	-32	G (4 - 20) GSP (24 - 32)	-5	-20	C5 (6,10,16,20) C5X (5,8,12)	HF
C5CXH	Expected Spring 2015			-5	-16	PCSS / C5	-5	-16	C5/C5X	HF
C5M	Expected Spring 2015			-12	-64	GL (12-64) G (12-20)	-12	-64	GL (12-32), G (12) G4H (40-64)	H (G) HF (GL) HF (G4H)
GMV (w/ fire sleeve)	GMV Expected Spring 2015			-12	-20	GL	-12	-20		
G4H (w/ fire sleeve)	GMV Expected Spring 2015			-12	-20	GL	-12	-20		

NOTE: This chart is subject to change. If the information you need is not shown contact Gates Product Application.



# A SUMMARY OF SAE J1273 SEP 2014

## SCOPE

This summary provides guidelines for safety, selection, routing, fabrication, installation, replacement, maintenance, and storage of hose and hose assemblies. These are the recommended practices for hydraulic hose, but are also appropriate for many other hose and systems.

## SAFETY

Safety should be a paramount concern whenever working with a hydraulic system. The fluids conveyed are often at high temperatures and extremely high pressures which present unique dangers.

Hydraulic fluid injuries are generally very severe and may come in several forms. Fluid injections wounds may occur any time there is a leak in a hydraulic system. Never check for leaks or damage to a hydraulic system by feel, the best case scenario with a fluid injection wound is months of painful treatment to recover, addition risks include amputation and death. Due to the high temperatures any time a user is exposed to hydraulic fluids severe burns may result, this exposure may be a result of an assembly failure or even oil released during maintenance. Additionally there is a danger of fire or explosion if a hose fails around a hot engine or exhaust manifold, or if a static discharge takes place in a fluid spray.

Unconstrained hose may whip on pressurization or in the event of failure and are extremely dangerous. Additionally during the release of pressure on the hydraulic system improperly secured booms or other cylinder supported components may drop suddenly.

A sometimes less recognized risk is that of electrical shock. Any equipment used to work around live electrical lines (such as lifts, etc). Should be equipped with hydraulic hose rated as non-conductive. This is because most hydraulic hose have wire reinforcement and are inherently conductive. Also even when non-conductive hose are used it is important to recognize that hydraulic fluids may also act as conductors.

## HOSE SELECTION

The Gates STAMPED process is the industry accepted standard for hose selection, this process involves determining the following properties:

## SIZE

- Internal diameter requirements will affect fluid velocity and outside diameter may also sometime be concern for routing purposes. When in doubt match existing specifications.

## TEMPERATURE

- The maximum recommended hose temperature should never be exceeded, either in the fluid conveyed or on the exterior of the hose. Similarly special hose are available which will maintain flexibility at very low temperatures, always follow manufacturer guidelines.

## APPLICATION

- Environmental conditions such as ultraviolet light, salt water, air pollutants, temperature, ozone, chemicals, electricity, abrasion and paint application will all negatively impact hose assembly life.
- Static Discharge can become an issue when non-polar liquids or mixtures including non-polar liquids are conveyed in non-conductive hose. A static charge will build and on discharge perforate the hose tube, to avoid this use conductive tube products when conveying non-polar, or mixtures of non-polar, liquids.
- Electrical Conductivity of hydraulic hose or conveyed fluids is an issue with equipment used to work around electrical lines. If hydraulic equipment is to be used around electrical lines, always use hydraulic hose rated as non-conductive.
- The cleanliness requirements of a final hose assembly will be determined by the system it is to be applied too. Always follow the equipment manufacturer's recommended cleanliness standard.
- Be sure to select products which will meet any regulatory standards required in the application. Examples of these standards would include: SAE, USCG, EN/DIN, ABS, etc.
- Never place hose in a position where they are pulled on. Hose are designed to hold pressure and convey fluids, exposing them to axial loads will cause premature failure.
- Any special or unusual applications should always be approved by the hose manufacturer, otherwise additional independent testing may be required.

## MATERIALS

- Permeation, or effusion, is the movement of a substance through the hose tube walls which may degrade the hose tube, cause cover blistering, or other undesired effects, and must be considered especially when conveying compressed gasses.
- Be sure to select a hose which is compatible and approved by the manufacturer for the fluid conveyed. Concentration, pressure, temperature and other factors may impact the compatibility of the hose and fluid.

EQUIPMENT
HOSE/CPLG. SELECTION
G8K COUPLINGS
GLOBAL SPIRAL COUPLINGS
STAINLESS STEEL SPIRAL
MEGACRIMP COUPLINGS
STAINLESS STEEL BRAID
POWER CRIMP COUPLINGS
FIELD ATTACHABLE G1 & G2 COUPLINGS
FIELD ATTACHABLE C5 COUPLINGS
C14 COUPLINGS
GL COUPLINGS
GLX COUPLINGS
PCTS THERMOPLASTIC COUPLINGS
POLARSEAL COUPLINGS (ACA)
POLARSEAL II COUPLINGS (ACC)
POLARSEAL II COUPLINGS (ACB)
POWER STEERING
ADAPTERS
QUICK DISCONNECT COUPLERS
BALL VALVES
LIVE SWIVEL
ASSEMBLY FABRICATION
ACCESSORIES
EQUIPMENT AND PARTS
KITS
AIR BRAKE HOSE ASSY
BRASS

EQUIPMENT
<b>HOSE/CPLG. SELECTION</b>
G8K COUPLINGS
GLOBAL SPIRAL COUPLINGS
STAINLESS STEEL SPIRAL
MEGACRIMP COUPLINGS
STAINLESS STEEL BRAID
POWER CRIMP COUPLINGS
FIELD ATTACHABLE G1 & G2 COUPLINGS
FIELD ATTACHABLE C5 COUPLINGS
C14 COUPLINGS
GL COUPLINGS
GLX COUPLINGS
PCTS THERMOPLASTIC COUPLINGS
POLARSEAL COUPLINGS (ACA)
POLARSEAL II COUPLINGS (ACC)
POLARSEAL II COUPLINGS (ACB)
POWER STEERING
ADAPTERS
QUICK DISCONNECT COUPLERS
BALL VALVES
LIVE SWIVEL
ASSEMBLY FABRICATION
ACCESSORIES
EQUIPMENT AND PARTS
KITS
AIR BRAKE HOSE ASSY
BRASS

**PRESSURE**

- The maximum working pressure of a hose assembly is the lowest working pressure of any component of the assembly.
- Hose should be sized with a working pressure equal to or above the maximum pressure encountered in a system. High frequency electronic transducers will be necessary to determine the maximum surge, or impulse, pressure in a system.
- If a hose assembly will be exposed to suction, be sure it is rated to hold the maximum suction and pressure in that portion of the system.
- Any time a hose assembly is to be exposed to external pressures, which may exceed the internal hose pressures, be sure to consult the hose manufacturer for recommendations.

**ENDS**

- Always use manufacturer approved couplings for hose assemblies. Be sure to select the appropriate end termination for a system working pressure and other requirements such as vibration resistance.

**DELIVERY**

- Always follow manufacturer recommendations for maximum fluid velocity within a hose. Excessive fluid velocity may cause excessive pressure loss, heat generation, hose movement or whipping, system noise, and hammer effects.

**HOSE ROUTING**

Proper attention to good hose routing and application practices will ensure reliable function of hose assemblies. The following is a short list of factors to consider when routing hose.

- Vibration: Consider vibration requirements when selecting hose and predicting service life. Clamps, dampers, and other mechanisms may be necessary to reduce vibration.
- Cover protection: Protect the hose cover from abrasion, erosion, snagging, and cutting. Special abrasion-resistant hose and hose guards are available for additional protection. Route the hose to reduce abrasion from hose rubbing other hose or objects that may abrade it.
- External Physical Abuse: Route hose to avoid tensile (pulling) loads, side loads, flattening, thread damage, kinking, damage to sealing surfaces, abrasion and twisting.
- Swivel Adapters: Swivel-type fittings or adapters do not transfer torque to hose while being tightened. Use these as needed to prevent twisting during installation.

- Live Swivels: If two components in the system are rotating in relation to each other, live swivels may be necessary. These connectors reduce the torque transmitted to the hose.
- Slings and Clamps: Use slings and clamps to support heavy or long hose and to keep it away from moving parts. Use clamps that prevent hose movement that will cause abrasion. Care shall be taken to prevent the sling clamp from abraiding the hose. Avoid over tightening of slings or clamps.
- MBR: Routing during assembly and use at less than minimum bend radius may reduce hose life. Sharp bending at the hose/fitting juncture may result in leaking, hose rupturing, or the hose assembly blowing apart. A minimum straight length of 1.5 times the hose's outside diameter shall be allowed between the hose fitting and the point at which the bend starts.
- Elbows and Adapters: Use elbows or adapters to relieve hose strain due to routing.
- Lengths: Unnecessarily long hose can increase pressure drop and affect system performance. When pressurized, hose that is too short may pull loose from its fittings, or stress the hose fitting connections, causing premature metallic or seal failures.
- Motion Absorbtion: Provide adequate hose length to distribute movement and prevent bends smaller than the minimum bend radius.
- Hose Movement and Bending (multi plane bending): Hose allows relative motion between system components. Analyze this motion when designing hose systems. The number of cycles per day may significantly affect hose life. Also avoid multiple planes of motion and twisting motion.
- Hose and machine tolerances: Design hose to allow for changes in length due to machine motion and tolerances.
- Hose length change due to pressure: Design hose to accommodate length changes from changing pressures.
- Do not cross or clamp together high- and low-pressure hose. The difference in length changes could wear the hose covers.

**HOSE ASSEMBLY FABRICATION**

- Component inspection: Before creating an assembly be sure to inspect all components to be sure they are the correct product, cut correctly, and do not have any visually identifiable defects.
- Couplings (compatibility): Hose fitting components from one manufacturer are not usually compatible with fitting components supplied by another manufacturer. Never mix and match hose and couplings from different manufacturers, unless approved by both parties.



- Hose assembly equipment (crimpers): Hose and fittings from one manufacturer should not generally be assembled with the equipment of another manufacturer.
- Safety Equipment: During fabrication, use proper safety equipment, including eye protection, respiratory protection, and adequate ventilation.
- Reuse of Hose and Fittings: Damaged hose and fittings shall not be used.
  - Never reuse: Field-attachable fittings that have blown or pulled off hose
  - Never reuse: Any part of hose fittings that were permanently crimped or swaged to hose
  - Never reuse: Hose that has been in service
- Cleanliness: Hose assemblies may be contaminated during fabrication. Clean hose to specified cleanliness levels.
- Temperature: The fabrication of hose assemblies should be performed at an ambient temperature over 0°C.
- Assembly inspection: After assembly, hose assemblies shall be inspected for visible defects and interior obstructions.
- Marking: Hose assemblies shall be marked in accordance with any relevant standards.

**HOSE ASSEMBLY INSTALLATION AND REPLACEMENT**

- Before installation inspect the hose assembly for:
  - Hose length and routing for compliance with original design
  - Correct style, size, length, and visible nonconformities
  - Coupling sealing surfaces for burrs, nicks, or other damage
- Handling during installation: Handle hose with care during installation. Kinking hose, or bending at less than minimum bend radius may reduce hose life. Avoid sharp bending at the hose/fitting juncture. Before and during installation, hose assemblies should be at a temperature above 0°C.
- Twist angle and orientation: To avoid twisting, which shortens hose life, the hose layline can be used as a reference. Twisting can also be avoided through the use of two wrenches during the installation of swivel connectors.

Securement and protection: Install necessary restraints and protective devices. Determine that such devices do not create additional stress or wear points.

Assembly Torque: Always follow the manufacturer recommended coupling installation practices, and torque or flats values. Improper installation may result in a leaking connection.

System Checkouts: In hydraulic or other liquid systems, eliminate all air entrapment after completing the installation. Follow manufacturers’ instructions to test the system for possible malfunctions and leaks.

**MAINTENANCE INSPECTION**

As part of regular equipment maintenance, hose assemblies should always be checked for deterioration.

Frequency: Evaluate factors such as the nature and severity of the application, past history, and manufacturers’ information to establish the frequency of inspections.

Visual Inspection: Only visually inspect for leaks. NEVER attempt to feel a leak, which could cause a fluid injection wound. Look for leaks, weeping, hose cracking, deformation, hardening or softening, rust, noise, smells, and any other defect which indicates a hose assembly may require replacement.

**HOSE STORAGE**

Age control: Store hose in a manner that facilitates age control and first-in, first-out usage based on manufacturing date on hose or hose assembly. Any hose or assembly in storage for more than two years should be visually inspected and proof pressure tested.

Storage Conditions will greatly affect hose shelf life, always store hose in the manufacturers’ original packaging. Avoid high temperatures, ozone, solvents and their vapors, corrosive (acid or basic) liquids and fumes, rodents, extremes in humidity, ultraviolet light, insects, radiation, strong, electro-magnetic fields, molds, and fungi.

Basic Testing for Usability: Flex the hose to the minimum bend radius and compare it with new hose. After flexing, examine the cover and tube for cracks. If any appear, no matter how small, reject the hose.

If the hose is wire reinforced, and the hose is unusually stiff, or a cracking sound is heard during flexing, check for corrosion by cutting away a section of the cover from a sample. Corrosion would be another reason for rejection.

If doubt still persists, contact hose assembler to conduct proof-pressure tests or any other tests needed to verify hose quality.

**REFERENCES**

All of the material presented here may be explored in more detail by obtaining the original standards from the appropriate regulatory agency.

**SOCIETY OF AUTOMOTIVE ENGINEERS (SAE)**

- SAE J343 Test and Test Procedures for SAE 100R Series Hydraulic Hose and Hose Assemblies
- SAE J514 Hydraulic Tube Fittings
- SAE J517 Hydraulic Hose

**INTERNATIONAL STANDARDS ORGANIZATION (ISO)**

- ISO 3457 Earth moving machinery—Guards and shields—Definitions and specifications
- ISO 2230 Rubber products—Guidelines for storage
- ISO 8331 Rubber and plastics hose and hose assemblies—Guide to selection, storage, use and maintenance

EQUIPMENT
HOSE/CPLG. SELECTION
G8K COUPLINGS
GLOBAL SPIRAL COUPLINGS
STAINLESS STEEL SPIRAL
MEGACRIMP COUPLINGS
STAINLESS STEEL BRAID
POWER CRIMP COUPLINGS
FIELD ATTACHABLE G1 & G2 COUPLINGS
FIELD ATTACHABLE C5 COUPLINGS
C14 COUPLINGS
GL COUPLINGS
GLX COUPLINGS
PCTS THERMOPLASTIC COUPLINGS
POLARSEAL COUPLINGS (ACA)
POLARSEAL II COUPLINGS (ACC)
POLARSEAL II COUPLINGS (ACB)
POWER STEERING
ADAPTERS
QUICK DISCONNECT COUPLERS
BALL VALVES
LIVE SWIVEL
ASSEMBLY FABRICATION
ACCESSORIES
EQUIPMENT AND PARTS
KITS
AIR BRAKE HOSE ASSY
BRASS





# DOT FMVSS 106-74

## MOTOR VEHICLE SAFETY STANDARD FOR BRAKE HOSE

EQUIPMENT
HOSE/CPLG. SELECTION
G8K COUPLINGS
GLOBAL SPIRAL COUPLINGS
STAINLESS STEEL SPIRAL
MEGACRIMP COUPLINGS
STAINLESS STEEL BRAID
POWER CRIMP COUPLINGS
FIELD ATTACHABLE G1 & G2 COUPLINGS
FIELD ATTACHABLE C5 COUPLINGS
C14 COUPLINGS
GL COUPLINGS
GLX COUPLINGS
PCTS THERMOPLASTIC COUPLINGS
POLARSEAL COUPLINGS (ACA)
POLARSEAL II COUPLINGS (ACC)
POLARSEAL II COUPLINGS (ACB)
POWER STEERING
ADAPTERS
QUICK DISCONNECT COUPLERS
BALL VALVES
LIVE SWIVEL
ASSEMBLY FABRICATION
ACCESSORIES
EQUIPMENT AND PARTS
KITS
AIR BRAKE HOSE ASSY
BRASS

Gates has received an increasing number of inquiries about the Department of Transportation (DOT) regulation FMVSS-106 regarding air brake hose. The requirements of the standard were issued by the National Highway Traffic Safety Administration and are published in the Federal Register, 49 Code of Federal Regulations, Part 571 MVSS 106 Brake Hose.

**NOTE: Anyone making brake assemblies must be registered with the Department of Transportation.**

### WHAT IS FMVSS-106?

The standard is written with specifics on labeling, performance tests, tests procedures, and registration. It is not a standard for design specifications for motor vehicle brake hose, brake hose assemblies, or brake hose end fittings. The Standard No. 106 will ensure that each user of brake hose will be supplied only the highest quality of hose. DOT will conduct random performance testing in accordance with the test procedures to ensure that the hose, couplings, and assemblies meet FMVSS 106.

“The purpose of the standard is to reduce deaths and injuries occurring as a result of brake system failure from pressure or vacuum loss due to hose or hose assembly rupture.”

The regulations will apply to all over-the-road vehicles including trailers and motorcycles. Off-the-road vehicles will not be regulated if they are designed to operate on those other than public roads.

### BASIC PROVISIONS OF FMVSS-106.

1. Three types of brake hose are covered (hydraulic, air, and vacuum brake) together with couplings and hose assemblies. At this point, we will only focus on air brake hose and assemblies.
2. Performance level for brake hose is established instead of design specifications.
3. Permanent as well as reusable fittings are permissible with air brake hose. Inside and outside diameters standards for air brake hose intended for use with field attachable couplings have been established. These hose are identified as Type I and Type II.

### GATES CUSTOMER/ASSEMBLER WITH REGARD TO FMVSS-106.

1. Test (dimensional and pressure) each assembly or per customer’s requirements before it is packaged and delivered to the customer.
2. Two of every 100 air brake hose assemblies produced or per customer’s requirements are subjected to hydrostatic pressure testing and tensile strength (destructive) testing.

### LABELING OF AIR BRAKE HOSE.

Any customer crimping air brake assemblies must be registered with the National Traffic Safety Administration (NHTSA).

### THE NATIONAL HIGHWAY TRAFFIC SAFETY ADMINISTRATION (NHTSA) REQUIRES:

1. Product DOT CERTIFICATION. (Gates Corporation responsibility. The Gates logo is our DOT registration.)
2. Registration of the assembler. (Customer/Distributor responsibility.)\*
3. Permanent assembly identification. (Customer/Distributor responsibility.) Refer to Gates frosted air brake hose labels below.

\* For customers needing to apply for Brake Hose Manufacturer’s Identification or Symbol, please follow the link to the manufacturers portal at <http://vpic.nhtsa.dot.gov/mfrportal/> and complete the appropriate form found in the dropdown menu. Domestic Brake hose manufacturers are required to complete the (49 CFR Part 566 form).

## FROSTED AIR BRAKE HOSE LABELS

**Product Number: 7484-0023**

**Part Number: 78214**

To assist you in complying with the NHTSA requirement for identifying brake hose assemblies, Gates now offers mylar hose labels.

- Self-adhesive
- 1” wide by 3-3/4” long, with a 1-1/2” by 1” white area on one end for printed information
- Format suitable for typewriters, computer printers or hand writing
- Accepts 9-10 typed characters per row, 4 or 5 on a row
- Wrap-around label resists damage from elements

### LABEL APPLICATION PROCEDURE:

1. Print appropriate information on label.
2. Wrap tag around hose assembly, printed end first.
3. Cover printed end with clear mylar tail of label.

Comes in 500 labels per pack.





# HOW TO MAKE HOSE ASSEMBLIES OF SPECIFIC LENGTHS

## Overall Assembly Length – C1 – C2 = Hose Cut Length

The "C" length for each coupling is listed in the catalog, as shown below.

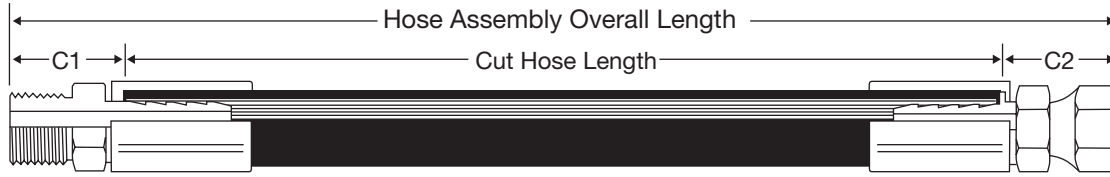

For the Gates Assembly 6M3K-8FJX-8MP-12.5

$$12.5'' - 1.38'' - 1.42'' = 9.7'' \text{ [Cut Hose Length]}$$

Descr.	Prod. No.	C		
		in	mm	mm
6G-8MP	7100-10095	1.42	36.1	36.1

Descr.	Prod. No.	C		
		in	mm	mm
6GE-8FJX	7100-10955	1.38	35.1	35.1

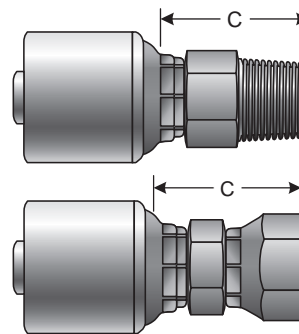

To meet SAE quality requirements: the final assembly must meet the dimensional requirements shown in the table on the right; the hose cut must be within 5° of perpendicular, on 1" hose this is less than 3/32"; and coupling orientation must be within 2° of specification, orientation which is off as little as one percent can half the life of a hose assembly.

Best practice to achieve these requirements is to begin by dry fitting all components of the assembly, then measure from one end of a coupling to the opposite end of the cut hose, crimp the coupling and measure the change in length. This will give a good estimate of change in hose length due to the crimping process, and allow for compensation. The use of witness marks to verify orientation and coupling insertion depth is also encouraged.

Assembly OAL (in)	Tolerance (in)
≤ 12	±0.125
12 < L ≤ 18	±0.1875
18 < L ≤ 36	±0.25
> 36	+ 1%*

\*to the nearest 0.125 inches

Assembly length tolerance (SAE J517)

When measuring a hose assembly, the point at which the ends of the assembly are measured will depend on the style and construction of the couplings. A summary of measurement points is shown below. More detailed information is available in the tech note "Overall Length of Hose Assemblies."

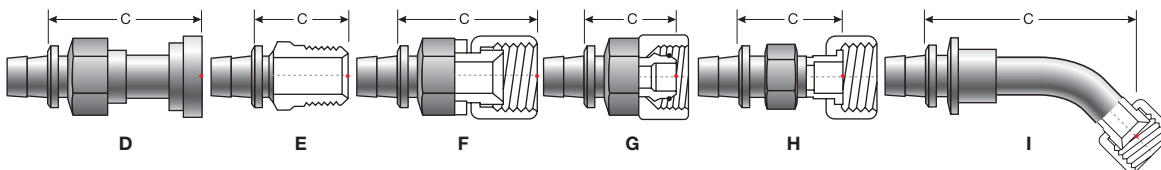

Coupling termination measurement points, from left to right: D) flange, E) straight male, F) US spec (SAE, JIC, NPSM), G) International spec (DIN, BSP, GAZ), H) FFOR and I) bent (elbow) couplings

EQUIPMENT
HOSE/CPLG. SELECTION
G8K COUPLINGS
GLOBALSPIRAL COUPLINGS
STAINLESS STEEL SPIRAL
MEGACRIMP COUPLINGS
STAINLESS STEEL BRAID
POWER CRIMP COUPLINGS
FIELD ATTACHABLE G1 & G2 COUPLINGS
FIELD ATTACHABLE C5 COUPLINGS
C14 COUPLINGS
GL COUPLINGS
GLX COUPLINGS
PCTS THERMOPLASTIC COUPLINGS
POLARSEAL COUPLINGS (ACA)
POLARSEAL II COUPLINGS (ACC)
POLARSEAL II COUPLINGS (ACB)
POWER STEERING
ADAPTERS
QUICK DISCONNECT COUPLERS
BALL VALVES
LIVE SWIVEL
ASSEMBLY FABRICATION
ACCESSORIES
EQUIPMENT AND PARTS
KITS
AIR BRAKE HOSE ASSY
BRASS





EQUIPMENT
HOSE/CPLG. SELECTION
G8K COUPLINGS
GLOBAL SPIRAL COUPLINGS
STAINLESS STEEL SPIRAL
MEGACRIMP COUPLINGS
STAINLESS STEEL BRAID
POWER CRIMP COUPLINGS
FIELD ATTACHABLE G1 & G2 COUPLINGS
FIELD ATTACHABLE C5 COUPLINGS
C14 COUPLINGS
GL COUPLINGS
GLX COUPLINGS
PCTS THERMOPLASTIC COUPLINGS
POLARSEAL COUPLINGS (ACA)
POLARSEAL II COUPLINGS (ACC)
POLARSEAL II COUPLINGS (ACB)
POWER STEERING
ADAPTERS
QUICK DISCONNECT COUPLERS
BALL VALVES
LIVE SWIVEL
ASSEMBLY FABRICATION
ACCESSORIES
EQUIPMENT AND PARTS
KITS
AIR BRAKE HOSE ASSY
BRASS

When you order hydraulic assemblies, be sure the following information is included as shown in the illustrations below:

1. Quantity of assemblies required.
2. Hose catalog description (dash size and type).
3. First coupling dash size and end style.
4. Second coupling dash size and end style.
5. Offset angle or orientation of couplings must be specified if both couplings contain bent tube ends.
6. Assembly overall length.

**Example:**

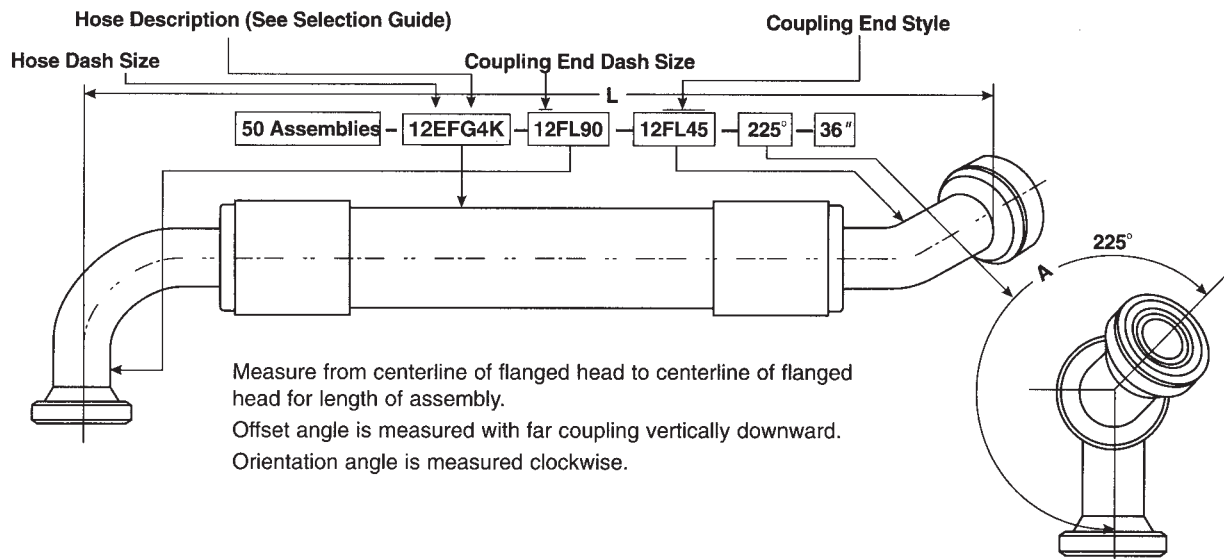
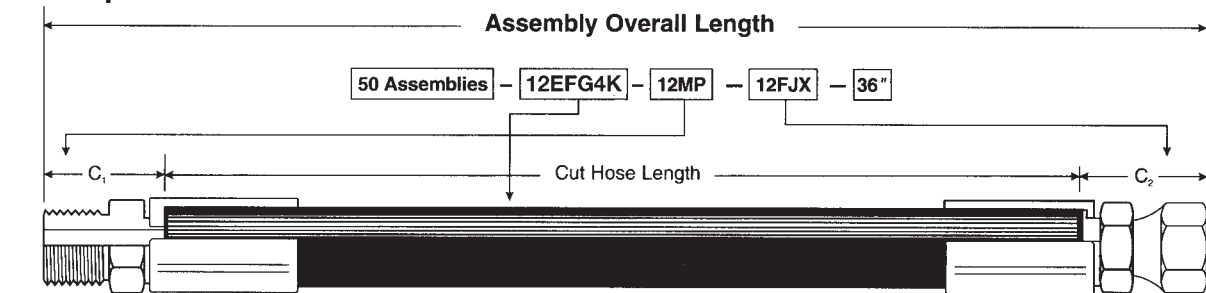

**CAUTION:**

**Rated working pressure** of the application should always determine selection of hose. Used up to the recommended **rated working pressure**, the hose will provide normal service life before replacement is required.

When new, the hose described in this catalog will meet or exceed the **minimum burst pressure** listed in the hose specification tables. However—as with any hose in the industry—after the hose has been impulsed for a length of time, **minimum burst pressure** will decrease from the figure shown in the specification tables.

Temperature ranges specified for specific hose refer to recommended temperature limits of fluids being conveyed or ambient temperatures. Exceeding these limits will cause degradation of material compounds and reduce hose service life.



# HOW TO DESCRIBE GATES HYDRAULIC HOSE ASSEMBLIES

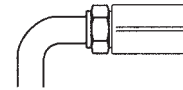
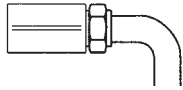

**Coupling A Information**

Male    Female

Angle \_\_\_\_° Drop:  S    M    L    XL  
or Drop Length \_\_\_\_ (mm)

**Thread**

JIC (37° Flare) \_\_\_\_\_

NPTF \_\_\_\_\_

O-Ring Boss \_\_\_\_\_

Flat-Face O-Ring (ORFS) \_\_\_\_\_

Code 61 \_\_\_\_\_

Code 62 \_\_\_\_\_

BSPP \_\_\_\_\_

DIN (Light/Heavy) \_\_\_\_\_

Other \_\_\_\_\_

**Hose Type**

Gates \_\_\_\_\_ I.D. \_\_\_\_\_  
or  
SAE 100R \_\_\_\_\_

**Dash Size:**

2    3    4    5    6  
 8    10    12    16    20  
 24    32    40    48    56  
 64

**Temperature** \_\_\_\_\_°

**Working Pressure (psi):**

100    101-250  
 250-499    500-1000  
 1001-2999    3000-3999  
 4000-5999    6000

**Application**

Return Line    Pressure Line  
 Intake Line    High Pressure Line  
 Special Fluid \_\_\_\_\_

**Coupling B Information**

Male    Female

Angle \_\_\_\_° Drop:  S    M    L    XL  
or Drop Length \_\_\_\_ (mm)

**Thread**

JIC (37° Flare) \_\_\_\_\_

NPTF \_\_\_\_\_

O-Ring Boss \_\_\_\_\_

Flat-Face O-Ring (ORFS) \_\_\_\_\_

Code 61 \_\_\_\_\_

Code 62 \_\_\_\_\_

BSPP \_\_\_\_\_

DIN (Light/Heavy) \_\_\_\_\_

Other \_\_\_\_\_

**Overall Length** \_\_\_\_\_  In.    mm

**Coupling Orientation:** \_\_\_\_\_°

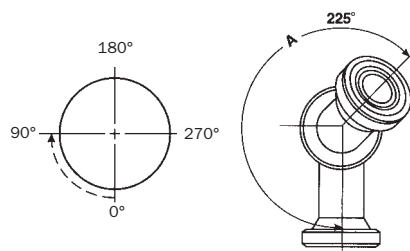

Measure from centerline of flanged head to centerline of flanged head for length of assembly.

Offset angle is measured with far coupling vertically downward.

Orientation angle is measured clockwise.

## HOSE GUARDS

	Full Length	Partial Length	From End of Coupling
<b>LifeGuard® Sleeve</b> 	<input type="checkbox"/>	_____	_____
<b>Wire Spring</b> 	<input type="checkbox"/>	_____	_____
<b>Flat Armor Spring</b> 	<input type="checkbox"/>	_____	_____
<b>Nylon Sleeve</b> 	<input type="checkbox"/>	_____	_____
<b>Plastic Coil Sleeve</b> 	<input type="checkbox"/>	_____	_____

EQUIPMENT
HOSE/CPLG. SELECTION
G8K COUPLINGS
GLOBAL SPIRAL COUPLINGS
STAINLESS STEEL SPIRAL
MEGACRIMP COUPLINGS
STAINLESS STEEL BRAID
POWER CRIMP COUPLINGS
FIELD ATTACHABLE G1 & G2 COUPLINGS
FIELD ATTACHABLE C5 COUPLINGS
C14 COUPLINGS
GL COUPLINGS
GLX COUPLINGS
PCTS THERMOPLASTIC COUPLINGS
POLARSEAL COUPLINGS (ACA)
POLARSEAL II COUPLINGS (ACC)
POLARSEAL II COUPLINGS (ACB)
POWER STEERING
ADAPTERS
QUICK DISCONNECT COUPLERS
BALL VALVES
LIVE SWIVEL
ASSEMBLY FABRICATION
ACCESSORIES
EQUIPMENT AND PARTS
KITS
AIR BRAKE HOSE ASSY
BRASS

## HOSE ASSEMBLY ROUTING TIPS



EQUIPMENT
HOSE/CPLG. SELECTION
G8K COUPLINGS
GLOBAL SPIRAL COUPLINGS
STAINLESS STEEL SPIRAL
MEGACRIMP COUPLINGS
STAINLESS STEEL BRAID
POWER CRIMP COUPLINGS
FIELD ATTACHABLE G1 & G2 COUPLINGS
FIELD ATTACHABLE C5 COUPLINGS
C14 COUPLINGS
GL COUPLINGS
GLX COUPLINGS
PCTS THERMOPLASTIC COUPLINGS
POLARSEAL COUPLINGS (ACA)
POLARSEAL II COUPLINGS (ACC)
POLARSEAL II COUPLINGS (ACB)
POWER STEERING ADAPTERS
QUICK DISCONNECT COUPLERS
BALL VALVES
LIVE SWIVEL
ASSEMBLY FABRICATION
ACCESSORIES
EQUIPMENT AND PARTS
KITS
AIR BRAKE HOSE ASSY
BRASS

Proper hose installation is essential for satisfactory performance. If hose length is excessive, the appearance of the installation will be unsatisfactory and unnecessary cost of equipment will be involved. If hose assemblies are too short to permit adequate flexing and changes in length due to expansion or contraction, hose service life will be reduced.

The following diagrams show proper hose installations which provide maximum performance and cost savings. Consider these examples in determining length of a specific assembly.

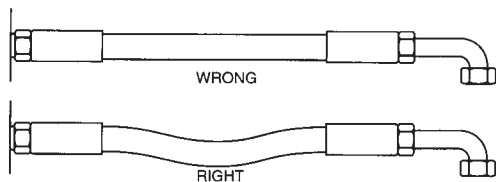

When hose installation is straight, allow enough slack in hose line to provide for length changes which will occur when pressure is applied.

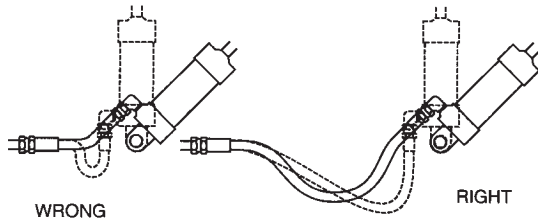

Adequate hose length is necessary to distribute movement on flexing applications and to avoid abrasion.

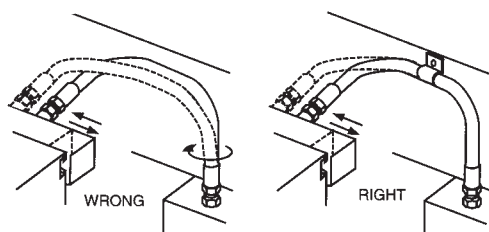

Avoid twisting of hose lines bent in two planes by clamping hose at change of plane.



Reduce number of pipe thread joints by using hydraulic adapters instead of pipe fittings.

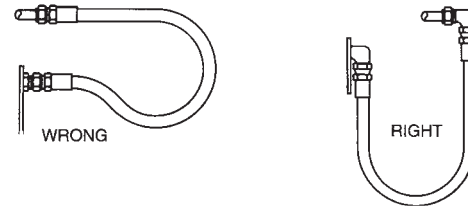

When radius is below the required minimum, use an angle adapter to avoid sharp bends.

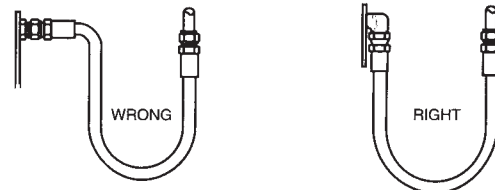

Use proper angle adapters to avoid tight bend in hose.

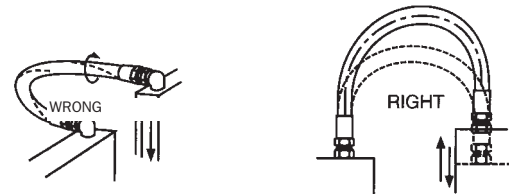

Prevent twisting and distortion by bending hose in same plane as the motion of the port to which hose is connected.

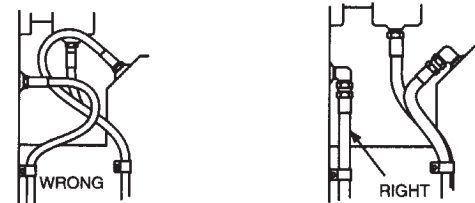

Route hose directly by using 45° and/or 90° adapter and fittings. Avoid excessive hose length to improve appearance.

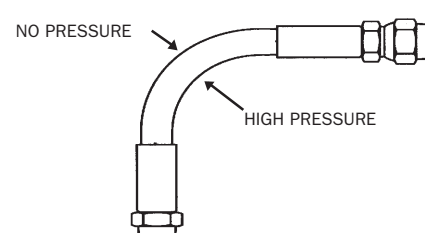

**Note:** To allow for length changes when hose is pressurized, do not clamp at bends so that curves will absorb changes. Do not clamp high and low pressure lines together.



## HOSE ASSEMBLY ROUTING TIPS - CONTINUED

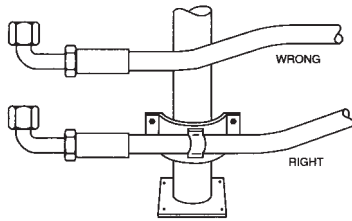

High ambient temperatures shorten hose life, so make sure hose is kept away from hot parts. If this is not possible, insulate hose.

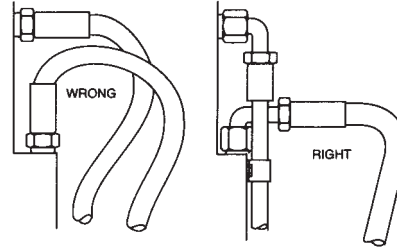

Elbows and adapters should be used to relieve strain on the assembly, and to provide neater installations which will be more accessible for inspection and maintenance.

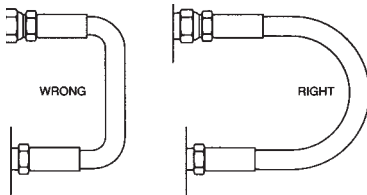

To avoid hose collapse and flow restriction, keep hose bend radius as large as possible. Refer to hose specification tables for minimum bend radius.

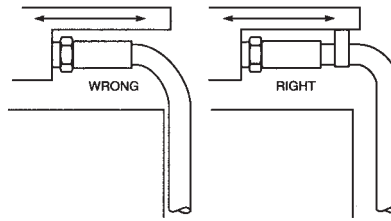

Run hose in the installation so that it avoids rubbing and abrasion. Often, clamps are required to support long hose runs or to keep hose away from moving parts. Use clamps of the correct size. A clamp too large allows hose to move inside the clamp and causes abrasion.

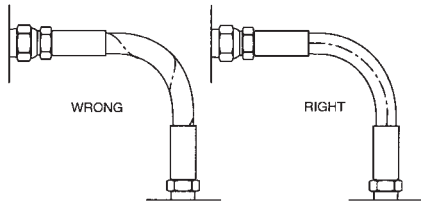

When installing hose, make sure it is not twisted. Pressure applied to a twisted hose can result in hose failure or loosening of connections.

### Hydraulic Flareless Assembly Procedure (per SAE J514 6.1.3 and 6.1.4)

1. Bottom the tube in the coupling, and tighten the nut until the ferrule just grips the tube. With a little experience, the technician can determine this point by feel. If the couplings are bench assembled, the gripping action can be determined by rotating the tube by hand as the nut is drawn down. When the tube can no longer be turned by hand, the ferrule has started to grip the tube.
2. After the ferrule grips the tube, tighten the nut one full turn. This may vary slightly with different tubing materials, but for general practice, it is a good rule for the technician to follow.

## GATES FIELD ATTACHABLE COUPLING INSTALLATION

1. Cut the hose end square with fine-tooth hacksaw or cut-off saw, the cut must be within 5° of perpendicular.
2. At a minimum be sure to blow out the hose to remove any rubber or metal dust, if higher levels of cleanliness are required utilize the MegaClean system or see the "Hose Assembly Cleanliness" tech note.

3. Be sure to thoroughly oil the stem and the inside of the hose. This is critical to ensure that



the ferrule and stem are easily placed onto the hose, without removing tube or cover material.

4. Secure the ferrule in a vise or adjustable wrench, then using a clockwise motion, thread the hose into the ferrule until it bottoms out on the inside shoulder of the ferrule. Once fully inserted, using a counter-clockwise motion, turn the hose back one half turn.



5. With the hose and ferrule secured, thread the stem into the hose and ferrule in a clockwise motion until the stem hex contacts the ferrule.



6. Finally clean the assembly to ensure that the desired cleanliness levels are achieved. Follow the same procedure as in step 2.

EQUIPMENT
HOSE/CPLG. SELECTION
G8K COUPLINGS
GLOBAL SPIRAL COUPLINGS
STAINLESS STEEL SPIRAL
MEGACRIMP COUPLINGS
STAINLESS STEEL BRAID
POWER CRIMP COUPLINGS
FIELD ATTACHABLE G1 & G2 COUPLINGS
FIELD ATTACHABLE C5 COUPLINGS
C14 COUPLINGS
GL COUPLINGS
GLX COUPLINGS
PCTS THERMOPLASTIC COUPLINGS
POLARSEAL COUPLINGS (ACA)
POLARSEAL II COUPLINGS (ACC)
POLARSEAL II COUPLINGS (ACB)
POWER STEERING
ADAPTERS
QUICK DISCONNECT COUPLERS
BALL VALVES
LIVE SWIVEL
ASSEMBLY FABRICATION
ACCESSORIES
EQUIPMENT AND PARTS
KITS
AIR BRAKE HOSE ASSY
BRASS

# INSTALLATION OF LIFEGUARD® LINE-OF-SIGHT SLEEVING



EQUIPMENT
HOSE/CPLG. SELECTION
G8K COUPLINGS
GLOBAL SPIRAL COUPLINGS
STAINLESS STEEL SPIRAL
MEGACRIMP COUPLINGS
STAINLESS STEEL BRAID
POWER CRIMP COUPLINGS
FIELD ATTACHABLE G1 & G2 COUPLINGS
FIELD ATTACHABLE C5 COUPLINGS
C14 COUPLINGS
GL COUPLINGS
GLX COUPLINGS
PCTS THERMOPLASTIC COUPLINGS
POLARSEAL COUPLINGS (ACA)
POLARSEAL II COUPLINGS (ACC)
POLARSEAL II COUPLINGS (ACB)
POWER STEERING
ADAPTERS
QUICK DISCONNECT COUPLERS
BALL VALVES
LIVE SWIVEL
ASSEMBLY FABRICATION
ACCESSORIES
EQUIPMENT AND PARTS
KITS
AIR BRAKE HOSE ASSY
BRASS

**1.** Determine LifeGuard® sleeve length using the following guidelines:

Sleeve length should exceed the length of free hose (distance between clamps that hold sleeve on) by the following amount:

**LifeGuard Sleeve Length = Free Hose Length (in) x 1.05**

All the decimals are rounded **up** to a full inch

**For example:** 11 ¾" free hose length x 1.05 = 12.34" ~ 13" LifeGuard sleeve length

**Note:** A minimum of ¾" of sleeve must extend beyond the clamps to properly clamp the sleeve. Sleeve cannot extend over the hex part of the fitting.

**2.** A hot knife is recommended to cut the sleeve as it will seal the ends as it cuts and keep the sleeving from unraveling. Gates also sells a guide table which keeps the sleeving in the correct, slightly open position to help simplify this process. Failure to use the guide table with the hot knife could result in both edges of the sleeve being melted together, which in turn makes hose insertion impossible.

If a hot knife is not available, cut sleeve with sharp scissors, and seal the edges of the sleeve to prevent unraveling and to strengthen it. Use flame torch to seal the inside white lining to the black outer sheath. Make sure sleeve end is spread apart before sealing ends with flame.



**3.** Before inserting the stems and crimping, verify whether the LifeGuard sleeve and collars can be installed after the couplings are crimped or must be installed prior to crimping the couplings.

- If the collars will fit over at least one of the couplings and also clear the backup hex nut, then the sleeve and collars can be assembled after the hose assembly is completely crimped.
- If the collars will not freely clear the termination and backup hex of at least one of the stems, then the sleeve and collars must be slid over the hose before crimping. In certain cases it may be desirable to do this anyway, even if the collars will fit. (An example would be when an assembly that uses long drop 90° couplings at both ends.)

**4.** The LifeGuard line-of-sight sleeve consists of two sleeves woven one inside the other. When inserting the hose, it is critical that the hose is positioned inside the white inner sleeve. Be careful not to snag the inside lining of the sleeve while inserting hose. If hose does not glide in easily, use hose insertion tool.

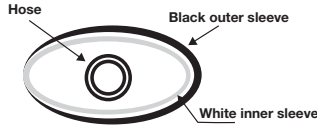

**5.** The aluminum collars must be free of burrs, sharp edges, gash marks and surface cracks/indentations. Embossing of these collars is permissible. The crimp O.D. for the aluminum collars depends on the hose type and ferrule used. Look up the proper crimp O.D. in eCrimp® (<http://www.gates.com/ecrimp>). The collars are listed numerically by product number. Match the collar product number to the hose type and ferrule product number being used. The collar crimp O.D. is listed in the table, directly to the right of the ferrule product number for each combination.

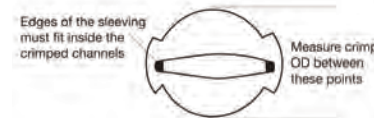

**Note:** Use PC707 LifeGuard die plate when making assemblies.

**Note:** The crimp O.D. tolerance for all aluminum collars used to hold LifeGuard line-of-sight nylon sleeving on hose assemblies is ±.005".

**WARNING:** Extra care must be taken when aligning the back-up hex of the coupling with the crimp dies during crimping of the LifeGuard assembly. Improperly positioned back-up hex can damage the die face.

**6.** Install proper die sets by first positioning the die plate in such manner as to let the notches rest against the back locator pins on the PC707 crimper. Then install the recommended die set taking extra care that the two die pins fit inside the two holes in the die plate.

**7.** Dial in crimp setting and crimp sleeve onto one end of the hose assembly.

**8.** To take the slack out of the sleeve, roll or twist the hose. This will take-up the excess in the sleeve, and help with crimping the other end of the assembly.

**9.** Pull back any remaining excess of the sleeve. Hold it in place and crimp the other end of the assembly.

**10.** LifeGuard crimp collars require specialized dies for their installation, since the final form of the collar is very different from a standard crimp. When crimping LifeGuard with the GC® 32 crimper, use eCrimp to determine the appropriate die and setting based on the hose and coupling to which it is to be attached. Once the die has been selected, care must be taken to ensure the die fingers are installed correctly. When using the LifeGuard die set, the fingers are properly aligned when the colored stripe forms a straight line across the die.



**GC® 32**

**11.** Your LifeGuard assembly is now ready to go.







**END CONFIGURATION SELECTION**

It is important to keep in mind that the hose assembly (coupling and hose) is only one component of the system. In choosing the correct end terminations for the couplings attached to the hose, formal design standards and sound engineering judgement should be used. In the absence of formal design standards, consider the following factors in choosing the proper end termination:

- Pressure
- Impulse frequency, amplitude and wave form
- Vibration
- Corrosion
- Dissimilar metals (galvanic corrosion)
- Maintenance procedures and frequency
- Installation reliability
- Connection's risk in the system
- Exposure to the elements
- Operator's and/or bystander's exposure to the connection
- Installation, operation and service activities and practices that affect safety

If there are any questions as to what end fittings should be used, Gates recommends that you consult your field sales representative or the Gates Hose and Connector Product Application Group for assistance.

**Stem and Ferrule Selection**

Choosing the proper stem and ferrule termination to be used in the assembly. Check the Gates Crimp Data Manual to ensure proper hose assembly components and crimp specifications.

Gates also offers eCrimp®, an online crimp database that can be accessed at [www.gates.com/ecrimp](http://www.gates.com/ecrimp).

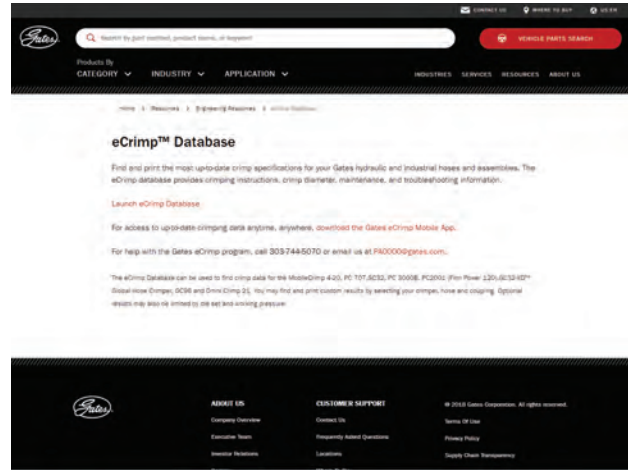

After determining the proper coupling components, refer to the Table of Contents in this catalog to find the proper coupling section. The ferrules are at the end of each coupling section.

**Stem Selection**

Different hose may require different coupling styles. To make your selection, determine the correct stem to be used. There are two functional ends of the stem to consider:

1. the hose end for hose attachment;
2. the thread end for port attachment.

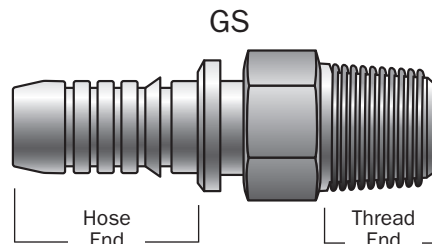

References to the coupling type(s) recommended for a specific hose are listed on the individual hose data pages; for example, EFG5K hose specifies GS couplings.

The thread end of a coupling (or adapter) can be identified by comparing the coupling being replaced or by measuring the port or thread end to which it is to be attached. See thread end identification nomenclature.

**Plating corrosion resistance - time to red rust**

SAE Minimum Standard	
>3X SAE	Gates TuffCoat®
6X SAE	TuffCoat® Xtreme™

EQUIPMENT
<b>HOSE/CPLG. SELECTION</b>
G8K COUPLINGS
GLOBAL SPIRAL COUPLINGS
STAINLESS STEEL SPIRAL
MEGACRIMP COUPLINGS
STAINLESS STEEL BRAID
POWER CRIMP COUPLINGS
FIELD ATTACHABLE G1 & G2 COUPLINGS
FIELD ATTACHABLE C5 COUPLINGS
C14 COUPLINGS
GL COUPLINGS
GLX COUPLINGS
PCTS THERMOPLASTIC COUPLINGS
POLARSEAL COUPLINGS (ACA)
POLARSEAL II COUPLINGS (ACC)
POLARSEAL II COUPLINGS (ACB)
POWER STEERING
ADAPTERS
QUICK DISCONNECT COUPLERS
BALL VALVES
LIVE SWIVEL
ASSEMBLY FABRICATION
ACCESSORIES
EQUIPMENT AND PARTS
KITS
AIR BRAKE HOSE ASSY
BRASS





# COUPLING AND ADAPTER END STYLE NOMENCLATURE

Gates couplings feature a meaningful description by combining end-style codes shown below that make thread end identification fast and easy. Always refer to Gates Crimp Data Manual when selecting hose and coupling combinations.

In the following example, the Gates description 12GS-12FJX90L identifies a GlobalSpiral™ Female JIC Swivel 90° Bend Long Drop coupling for -12 (3/4") hose size and -12 (3/4") stem size.

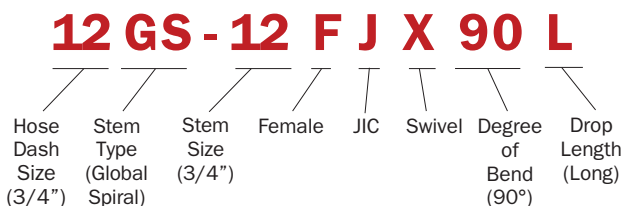

EQUIPMENT
<b>HOSE/CPLG. SELECTION</b>
G8K COUPLINGS
GLOBALSPIRAL COUPLINGS
STAINLESS STEEL SPIRAL
MEGACRIMP COUPLINGS
STAINLESS STEEL BRAID
POWER CRIMP COUPLINGS
FIELD ATTACHABLE G1 & G2 COUPLINGS
FIELD ATTACHABLE C5 COUPLINGS
C14 COUPLINGS
GL COUPLINGS
GLX COUPLINGS
PCTS THERMOPLASTIC COUPLINGS
POLARSEAL COUPLINGS (ACA)
POLARSEAL II COUPLINGS (ACC)
POLARSEAL II COUPLINGS (ACB)
POWER STEERING
ADAPTERS
QUICK DISCONNECT COUPLERS
BALL VALVES
LIVE SWIVEL
ASSEMBLY FABRICATION
ACCESSORIES
EQUIPMENT AND PARTS
KITS
AIR BRAKE HOSE ASSY
BRASS

Code	Description
A	Adapterless
AB	Air Brake
API	API Unions
B	Brass
BBDS	British Bonded Seal
BJ	Banjo
BKHD	Bulkhead
BL	Block
BS	Bite Sleeve
BSPP	British Standard Pipe Parallel
BSPT	British Standard Pipe Tapered
C	Caterpillar Flange
CC	Clamping Collar
DH	DIN Heavy
DL	DIN Light
F	Female
FABX	Female Air Brake Swivel
FBFFOR	Female British Flat-Face O-Ring
FBO	Female Braze-on Stem
FWO	Female Weldon
FF	Flat-Face
FFGX	Female French GAZ Swivel (Female Kobelco)
FFN	Female Flareless Nut
FOR	Flat-Face O-Ring
FFS	Female Flareless Sleeve
FG	Female Grease Thread
FKX	Female Komatsu Style Swivel
FL	Code 61 O-Ring Flange
FLC	Caterpillar Style O-Ring Flange
FLH	Code 62 O-Ring Flange Heavy
FLOS	Flange O-Ring Special
FT	Female SAE Tube
HLE	Hose Length Extender
HLEC	Hose Length Extender (Caterpillar)
HM	Hose Mender
HU	Hammer Union
I	Inverted Flare
J	JIC (37° Flare)
JIS	Japanese Industrial Standard
K	Komatsu Style (Japanese 30° Seat)

Code	Description
LH	Long Hex
LN	Lock Nut
M	Male
MB	Male Boss
MBAX	Male Boss Adapterless Swivel
MBDS	Metric Bonded Seal
MFA	Male Flareless Assembly (Ermeto)
MFG	Male French GAZ
MKB	Metric Kobelco
MM	Metric Male
MN	Metric Nut
MPG	Male Special Grease Fitting
MPLN	Male Pipe Long Nose
MLSP	Metric Light Stand Pipe
MSP	Metric Stand Pipe
NASP	North American Stand Pipe
OR	O-Ring
P	Pipe Thread (NPTF or NPSM)
PL	Press Lok®
PT	Port
PWX	Pressure Washer Swivel
QLH	Quick-Lok® High
QLL	Quick-Lok® Low
R	Field Attachable
S	SAE (45° Flare)
SP	Special
SS	Stainless Steel
TS	Tube Sleeve
TSN	Tube Sleeve Nut
X	Swivel
Z	Parker Triple Thread
22	22-1/2° Bent Tube Angle
30	30° Bent Tube Angle
45	45° Bent Tube Angle
60	60° Bent Tube Angle
67	67-1/2° Bent Tube Angle
90	90° Bent Tube Angle
110	110° Bent Tube Angle
135	135° Bent Tube Angle



# THREAD END DASH SIZES, DESCRIPTIONS AND DIMENSIONS

## Coupling Dash Size and End Style

Coupling dash size is a shorthand method of denoting the size of a particular end fitting (see Thread Chart).

EXAMPLE: 12MP denotes a 3/4" male pipe thread end fitting. The corresponding thread description for a 3/4" pipe thread is 3/4 -14 NPTF solid male.

EXAMPLE: 12FJX denotes a 3/4" female JIC swivel (37° seat) end fitting. The corresponding thread description for a 3/4" JIC thread is 1-1/16 – 12 JIC 37° flare swivel female.

EXAMPLE: 12FL denotes a 3/4" SAE standard pressure (Code 61) flange fitting. This is the standard fitting description for a 3/4" SAE standard pressure flange.

## Termination Drop Lengths

Bent tube couplings carry a suffix designation that specifies the degree of bend and the length of the drop.

For example, a 12FJX90S is a female JIC swivel with a 90 degree bend. The "S" designates an SAE J516 short drop length. The short and long drops are specified in SAE J516. Flat-face and metric couplings meet ISO-12151-1 drop length specifications. Medium drops are not specified and can vary from manufacturer to manufacturer.

**S** – Short Drop

**M** – Medium Drop

**L** – Long Drop

**XL** – Extra Long Drop

Special, non-industry standard drop lengths are designated with a numerical suffix instead of the S, M, L code. For example, a **12FJX90-075** designates a 75mm drop.

## JIC 37 Degree per SAE J516 and ISO 12151-5

Hose Size	Short Drop (mm)	Medium Drop (mm)	Long Drop (mm)
-4	21	32	46
-5	21	32	46
-6	23	38	54
-8	29	41	64
-10	32	47	70
-12	48	58	96
-16	56	71	114
-20	64	78	129
-24	69	86	141
-32	88	140	222

## Flange Code 61 or 62 per SAE J516 and ISO 12151-3

Hose Size	Short Drop (mm)	Medium Drop (mm)	Long Drop (mm)
-8	-	40	99
-12	-	58	133
-16	61	70	154
-20	68	90	189
-24	81	104	220
-32	120	138	275
-40	118	-	-
-48	141	-	-

## Thread End Catalog Descriptions

Gates coupling ends shown on the following pages are accepted as industry standards. See detailed catalog listings for availability of specific hose/coupling combinations, detailed descriptions, thread end configurations such as swivels, bent tubes and special ends.

EQUIPMENT
HOSE/CPLG. SELECTION
G8K COUPLINGS
GLOBAL SPIRAL COUPLINGS
STAINLESS STEEL SPIRAL
MEGACRIMP COUPLINGS
STAINLESS STEEL BRAID
POWER CRIMP COUPLINGS
FIELD ATTACHABLE G1 & G2 COUPLINGS
FIELD ATTACHABLE C5 COUPLINGS
C14 COUPLINGS
GL COUPLINGS
GLX COUPLINGS
PCTS THERMOPLASTIC COUPLINGS
POLARSEAL COUPLINGS (ACA)
POLARSEAL II COUPLINGS (ACC)
POLARSEAL II COUPLINGS (ACB)
POWER STEERING
ADAPTERS
QUICK DISCONNECT COUPLERS
BALL VALVES
LIVE SWIVEL
ASSEMBLY FABRICATION
ACCESSORIES
EQUIPMENT AND PARTS
KITS
AIR BRAKE HOSE ASSY
BRASS

EQUIPMENT
HOSE/CPLG. SELECTION
G8K COUPLINGS
GLOBAL SPIRAL COUPLINGS
STAINLESS STEEL SPIRAL
MEGACRIMP COUPLINGS
STAINLESS STEEL BRAID
POWER CRIMP COUPLINGS
FIELD ATTACHABLE G1 & G2 COUPLINGS
FIELD ATTACHABLE C5 COUPLINGS
C14 COUPLINGS
GL COUPLINGS
GLX COUPLINGS
PCTS THERMOPLASTIC COUPLINGS
POLARSEAL COUPLINGS (ACA)
POLARSEAL II COUPLINGS (ACC)
POLARSEAL II COUPLINGS (ACB)
POWER STEERING
ADAPTERS
QUICK DISCONNECT COUPLERS
BALL VALVES
LIVE SWIVEL
ASSEMBLY FABRICATION
ACCESSORIES
EQUIPMENT AND PARTS
KITS
AIR BRAKE HOSE ASSY
BRASS

When identifying hydraulic couplings, it is important to identify the type of seal made. There are three major types of coupling interfaces used in hydraulics today: Thread Interface, O-Rings and Mated Angle or Mechanical Joint. These three interfaces have developed differently in different parts of the world. In the following pages, country of origin and the coupling styles found in each country are identified. Brief descriptions and dimensional data help identify your particular coupling style.

## Identifying couplings is as easy as 1-2-3!

### 1. Determine Seal Type.

- Thread Interference
- O-Ring
- Mated Angle or Mechanical Joint
- Mated Angle with O-Ring

**Thread Interference.** A characteristic of this thread is that the male is thinner at the front than it is at the back. As the male is threaded into the female, the edges of the thread distort by flattening out. This distortion creates the seal.

**O-Ring.** The o-ring on the male being compressed against the corresponding female makes this seal. This type of seal is excellent for high-pressure applications. The threads pull the fitting against the port, trap the o-ring and flatten it to form a tight seal.

**Mated Angle or Mechanical Joint.** Different angles are used to create the seal. The seal takes place where the two angles meet and are wedged into one another. These can be cut with the angle either being inverted or standard. Standard seat couplings have the nose angle of the male on the outer surface of the coupling. Inverted seat couplings contain the nose angle of the male on the inside bore of the coupling.

**Mated Angle with O-Ring.** These couplings are a hybrid, which use both the mated angle and the o-ring to make the seal.

### 2. Visual Identification.

Thread Interference. These are the easiest because the only factor here is whether the termination is male or female. Couplings that use this seal are:

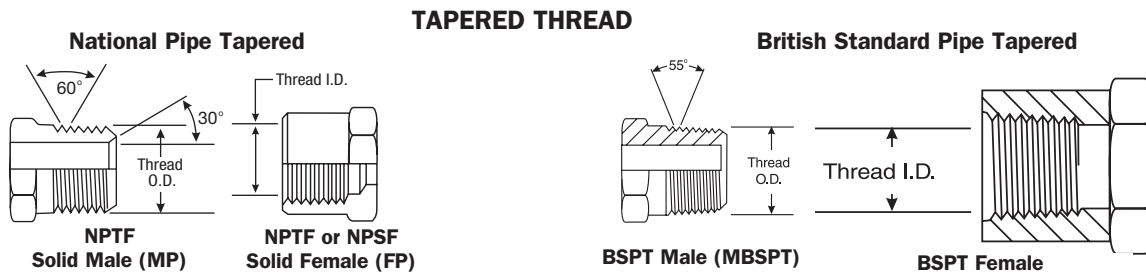

**O-Ring.** Two determinations are needed:

- A. O-Ring Location – Flange Groove, Outside, or on the Nose Seat
- B. Coupling Termination – Male or Female

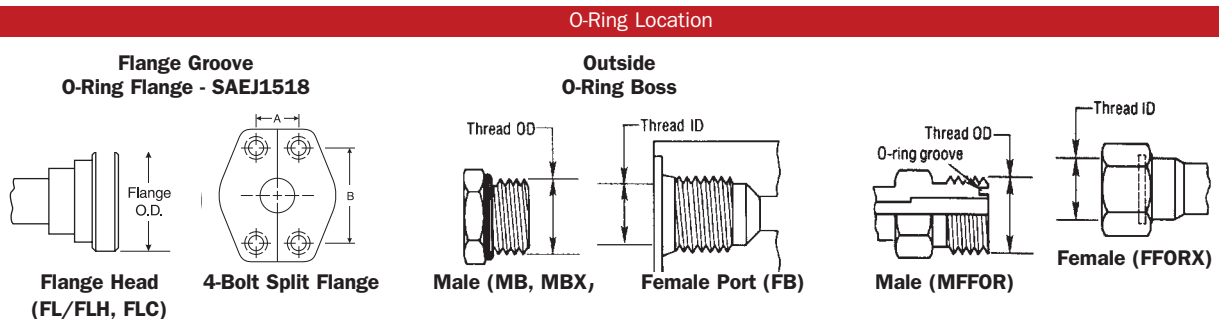



**2. Visual Identification - Continued**

**Mated Angle or Mechanical Joint.** Determine:

- A. Nose Seat – Standard or Inverted
- B. Seat Angle (See Measuring Seat Angles)
- C. Coupling Termination

**Standard Nose Seat**

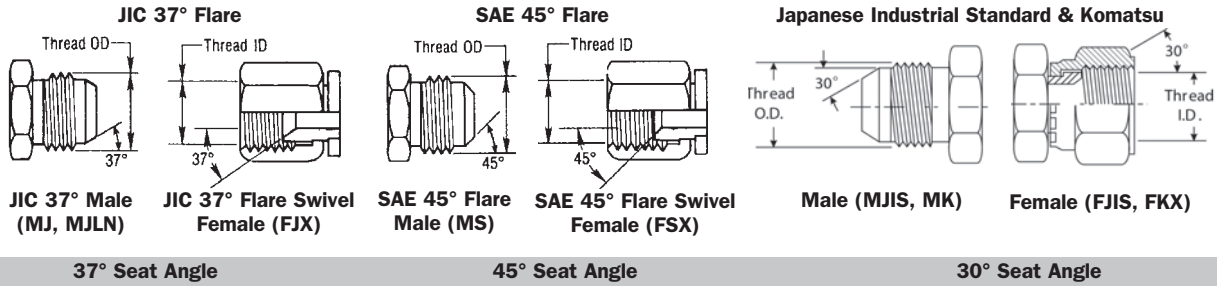

**Inverted Nose Seats**

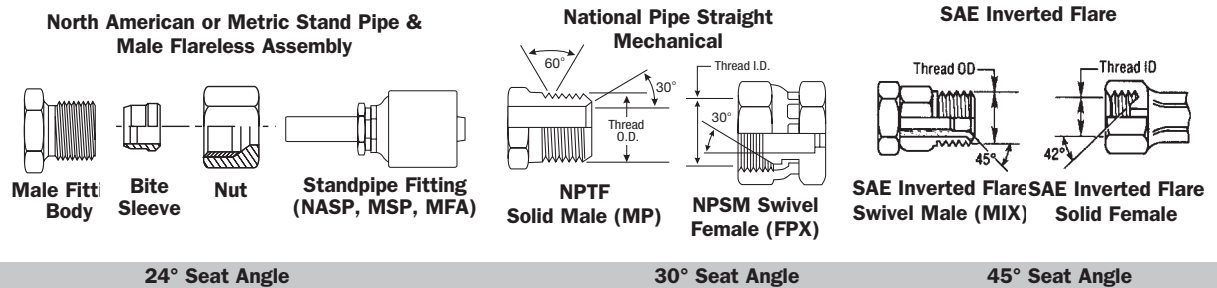

**Mated Angle with O-Ring.** Determine:

- A. O-Ring Location
- B. Nose Seat
- C. Seat Angle (See Measuring Seat Angles)
- D. Coupling Termination

**Inside O-Ring Location with Inverted Nose Seat**

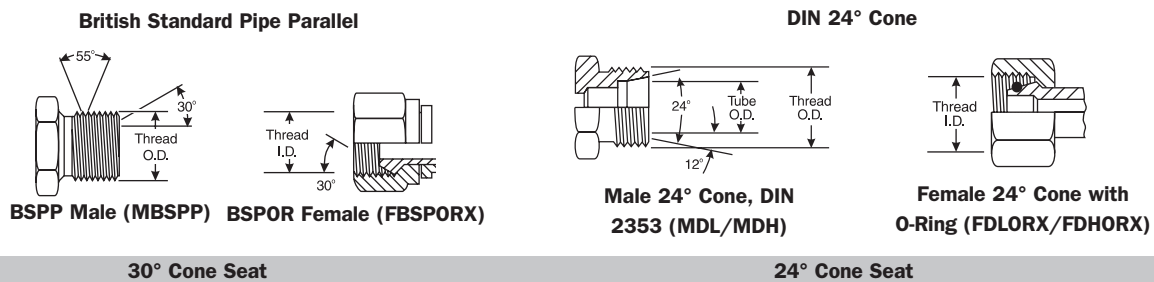

For a wall poster representation of this information, order literature form number 428-7125.

EQUIPMENT
HOSE/CPLG. SELECTION
G8K COUPLINGS
GLOBAL SPIRAL COUPLINGS
STAINLESS STEEL SPIRAL
MEGACRIMP COUPLINGS
STAINLESS STEEL BRAID
POWER CRIMP COUPLINGS
FIELD ATTACHABLE G1 & G2 COUPLINGS
FIELD ATTACHABLE C5 COUPLINGS
C14 COUPLINGS
GL COUPLINGS
GLX COUPLINGS
PCTS THERMOPLASTIC COUPLINGS
POLARSEAL COUPLINGS (ACA)
POLARSEAL II COUPLINGS (ACC)
POLARSEAL II COUPLINGS (ACB)
POWER STEERING
ADAPTERS
QUICK DISCONNECT COUPLERS
BALL VALVES
LIVE SWIVEL
ASSEMBLY FABRICATION
ACCESSORIES
EQUIPMENT AND PARTS
KITS
AIR BRAKE HOSE ASSY
BRASS



EQUIPMENT
HOSE/CPLG. SELECTION
G8K COUPLINGS
GLOBAL SPIRAL COUPLINGS
STAINLESS STEEL SPIRAL
MEGACRIMP COUPLINGS
STAINLESS STEEL BRAID
POWER CRIMP COUPLINGS
FIELD ATTACHABLE G1 & G2 COUPLINGS
FIELD ATTACHABLE C5 COUPLINGS
C14 COUPLINGS
GL COUPLINGS
GLX COUPLINGS
PCTS THERMOPLASTIC COUPLINGS
POLARSEAL COUPLINGS (ACA)
POLARSEAL II COUPLINGS (ACC)
POLARSEAL II COUPLINGS (ACB)
POWER STEERING
ADAPTERS
QUICK DISCONNECT COUPLERS
BALL VALVES
LIVE SWIVEL
ASSEMBLY FABRICATION
ACCESSORIES
EQUIPMENT AND PARTS
KITS
AIR BRAKE HOSE ASSY
BRASS

**Measuring Seat Angles**

Using the seat gauge, determine the angle of the seat, as illustrated. When the centerline of the seat gauge extends parallel with the projected longitudinal axis of the coupling, then the angles of the gauge and seat match.

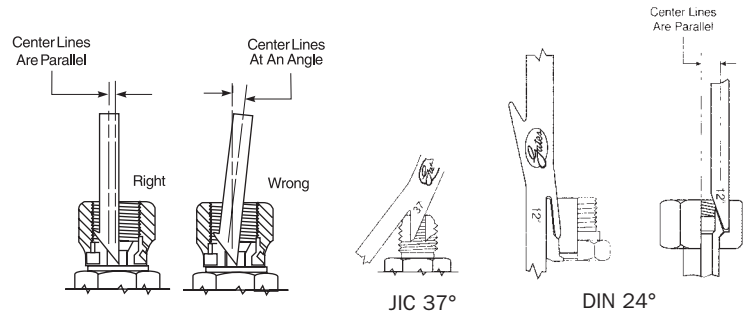

**NOTE:** Thread binding will occur when different thread configurations are used. DO NOT mix thread configurations.

**3. Measure Threads.**

Because some couplings have very similar characteristics, the only way to determine the correct identification is by measuring the thread. Follow the procedure below when measuring coupling threads:

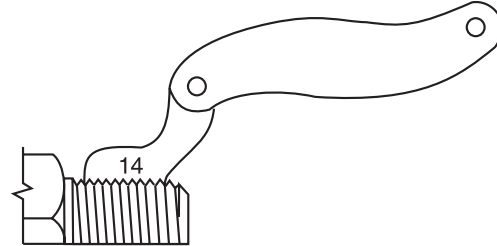
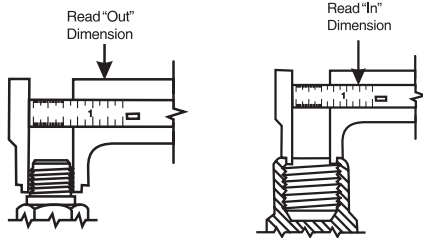

With the caliper measure the thread diameter of the largest point. (Outside Diameter (O.D.) of male threads—Inside Diameter (I.D.) of female threads.)

Using the thread gauge, determine the number of threads per inch. Comparison of gauge and coupling threads against a lighted background will ensure an accurate reading.

Match the measurements taken above against those in the following tables that appear to be similar to the coupling under consideration.

**Gates provides many useful tools to assist you in identifying the right coupling!**



### HYDRAULIC COUPLING TEMPLATES

**Automotive Number:** 428-7108  
**Industrial Number:** 39549



These templates provide a fast and easy way to measure North American threads, International threads, flange ends, seat angles (37° and 45°) and hose I.D.

### STAINLESS STEEL DIGITAL CALIPER

**Part Number:** 78241  
**Product Number:** 7369-0322



Caliper features an easy-to-read LCD screen clearly displaying the crimp diameter digitally. Capable of four-way measurement: inside, outside, depth and step. Constructed of hardened stainless steel and comes in a handy, protective carrying case.

### INTERNATIONAL THREAD IDENTIFICATION KIT

**Part Number:** 70264  
**Product Number:** 7369-0015



Attractive carrying case suitable for counter display and field sales calls. Contains male and female metric and British gauge for identifying thread size. Also includes pocket thread I.D. kit.

### NORTH AMERICAN THREAD IDENTIFICATION KIT

**Part Number:** 70270  
**Product Number:** 7369-0016



Attractive carrying case suitable for counter display and field sales calls. Contains 45 anodized gauges, male and female, for identifying pipe and UN/UNF 2A/2B threads. Also includes pocket thread ID kit.

EQUIPMENT
HOSE/CPLG. SELECTION
G8K COUPLINGS
GLOBAL SPIRAL COUPLINGS
STAINLESS STEEL SPIRAL
MEGACRIMP COUPLINGS
STAINLESS STEEL BRAID
POWER CRIMP COUPLINGS
FIELD ATTACHABLE G1 & G2 COUPLINGS
FIELD ATTACHABLE C5 COUPLINGS
C14 COUPLINGS
GL COUPLINGS
GLX COUPLINGS
PCTS THERMOPLASTIC COUPLINGS
POLARSEAL COUPLINGS (ACA)
POLARSEAL II COUPLINGS (ACC)
POLARSEAL II COUPLINGS (ACB)
POWER STEERING
ADAPTERS
QUICK DISCONNECT COUPLERS
BALL VALVES
LIVE SWIVEL
ASSEMBLY FABRICATION
ACCESSORIES
EQUIPMENT AND PARTS
KITS
AIR BRAKE HOSE ASSY
BRASS





EQUIPMENT
HOSE/CPLG. SELECTION
G8K COUPLINGS
GLOBAL SPIRAL COUPLINGS
STAINLESS STEEL SPIRAL
MEGACRIMP COUPLINGS
STAINLESS STEEL BRAID
POWER CRIMP COUPLINGS
FIELD ATTACHABLE G1 & G2 COUPLINGS
FIELD ATTACHABLE C5 COUPLINGS
C14 COUPLINGS
GL COUPLINGS
GLX COUPLINGS
PCTS THERMOPLASTIC COUPLINGS
POLARSEAL COUPLINGS (ACA)
POLARSEAL II COUPLINGS (ACC)
POLARSEAL II COUPLINGS (ACB)
POWER STEERING
ADAPTERS
QUICK DISCONNECT COUPLERS
BALL VALVES
LIVE SWIVEL
ASSEMBLY FABRICATION
ACCESSORIES
EQUIPMENT AND PARTS
KITS
AIR BRAKE HOSE ASSY
BRASS

## POCKET THREAD IDENTIFICATION KIT



**Part Number:** 86583

**Product Number:** 7369-4318

To properly identify the correct replacement couplings, the measuring tools shown here should be used.

- Contents:**
- Calipers
  - Seat Gauges (English)
  - Seat Gauges (Metric)
  - Thread Gauges
  - Thread I.D. Guide



# THREAD CHART

## THREAD CHART

DASH SIZE	2	3	4	5	6	7	8	10	12	14	16	20	24	32	40	48
<b>NPTF Pipe Thread</b>	1/8-27	1/4-18	3/8-18	1/2-14	5/8-14	3/4-14	7/8-14	1-11	1 1/16-11	1 1/8-11	1 1/4-11	1 1/2-11	1 3/4-11	2-11	2 1/2-11	3-11
<b>NPSM Swivel Thread</b>	1/8-27	1/4-18	3/8-18	1/2-14	5/8-14	3/4-14	7/8-14	1-11	1 1/16-11	1 1/8-11	1 1/4-11	1 1/2-11	1 3/4-11	2-11	2 1/2-11	3-11
<b>JIC 37° Flare Thread</b>	5/16-24	3/8-24	1/2-20	5/8-18	3/4-18	7/8-18	1-16	1 1/16-16	1 1/8-16	1 1/4-16	1 1/2-16	1 3/4-16	2-16	2 1/2-16	3-16	4-16
<b>SAE 45° Flare Thread</b>	5/16-24	3/8-24	1/2-20	5/8-18	3/4-18	7/8-18	1-16	1 1/16-16	1 1/8-16	1 1/4-16	1 1/2-16	1 3/4-16	2-16	2 1/2-16	3-16	4-16
<b>SAE O-Ring Thread</b>	5/16-24	3/8-24	1/2-20	5/8-18	3/4-18	7/8-18	1-16	1 1/16-16	1 1/8-16	1 1/4-16	1 1/2-16	1 3/4-16	2-16	2 1/2-16	3-16	4-16
<b>Fiat-Face Thread</b>	5/16-24	3/8-24	1/2-20	5/8-18	3/4-18	7/8-18	1-16	1 1/16-16	1 1/8-16	1 1/4-16	1 1/2-16	1 3/4-16	2-16	2 1/2-16	3-16	4-16
<b>Inverted Flare Thread</b>	5/16-28	3/8-24	1/2-20	5/8-18	3/4-18	7/8-18	1-16	1 1/16-16	1 1/8-16	1 1/4-16	1 1/2-16	1 3/4-16	2-16	2 1/2-16	3-16	4-16
<b>Compression Thread</b>	5/16-24	3/8-24	1/2-20	5/8-18	3/4-18	7/8-18	1-16	1 1/16-16	1 1/8-16	1 1/4-16	1 1/2-16	1 3/4-16	2-16	2 1/2-16	3-16	4-16
<b>Code 61 Flange Head O.D.</b>							1.19	1.335	1.50	1.75	2.00	2.38	2.81	3.31	4.00	
<b>Code 62 Flange Head O.D.</b>							1.25	1.62	1.62	1.88	2.12	2.50	3.12			
<b>BSPP Thread</b>	1/8-28	1/4-19	3/8-19	1/2-14	5/8-14	3/4-14	7/8-14	1-11	1 1/16-11	1 1/8-11	1 1/4-11	1 1/2-11	1 3/4-11	2-11	2 1/2-11	3-11
<b>BSPT Thread</b>	1/8-28	1/4-19	3/8-19	1/2-14	5/8-14	3/4-14	7/8-14	1-11	1 1/16-11	1 1/8-11	1 1/4-11	1 1/2-11	1 3/4-11	2-11	2 1/2-11	3-11
<b>Japanese Pipe Tapered Thread</b>	1/8-28	1/4-19	3/8-19	1/2-14	5/8-14	3/4-14	7/8-14	1-11	1 1/16-11	1 1/8-11	1 1/4-11	1 1/2-11	1 3/4-11	2-11	2 1/2-11	3-11
<b>Japanese Flare Thread</b>	1/8-28	1/4-19	3/8-19	1/2-14	5/8-14	3/4-14	7/8-14	1-11	1 1/16-11	1 1/8-11	1 1/4-11	1 1/2-11	1 3/4-11	2-11	2 1/2-11	3-11
<b>Copper/Nylon Air Brake Thread</b>	7/16-24	1/2-20	5/8-18	3/4-16	7/8-16	1-14	1 1/16-14	1 1/8-14	1 1/4-14	1 1/2-14	1 3/4-14	2-14	2 1/2-14	3-14	4-14	5-14
<b>METRIC (mm)</b>	8	10	12	14	16	18	20	22	24	26	30	33	36	42	45	52
<b>MDL</b>	M12X1.5	M14X1.5	M16X1.5	M18X1.5	M20X1.5	M22X1.5	M24X1.5	M26X1.5	M30X2.0	M36X2.0	M42X2.0	M48X2.0	M52X2.0	M58X2.0	M64X2.0	M72X2.0
<b>MDH</b>	M16X1.5	M18X1.5	M20X1.5	M22X1.5	M24X1.5	M26X1.5	M28X1.5	M30X1.5	M33X1.5	M36X1.5	M40X1.5	M42X1.5	M45X1.5	M48X1.5	M52X1.5	M56X1.5
<b>Komatsu</b>	M18X1.5	M20X1.5	M22X1.5	M24X1.5	M26X1.5	M28X1.5	M30X1.5	M33X1.5	M36X1.5	M40X1.5	M42X1.5	M45X1.5	M48X1.5	M52X1.5	M56X1.5	M60X1.5
<b>GAZ</b>	M20X1.5	M22X1.5	M24X1.5	M26X1.5	M28X1.5	M30X1.5	M33X1.5	M36X1.5	M40X1.5	M42X1.5	M45X1.5	M48X1.5	M52X1.5	M56X1.5	M60X1.5	M64X1.5

EQUIPMENT
HOSE/CPLG. SELECTION
G8K COUPLINGS
GLOBAL SPIRAL COUPLINGS
STAINLESS STEEL SPIRAL
MEGACRIMP COUPLINGS
STAINLESS STEEL BRAID
POWER CRIMP COUPLINGS
FIELD ATTACHABLE G1 & G2 COUPLINGS
FIELD ATTACHABLE C5 COUPLINGS
C14 COUPLINGS
GL COUPLINGS
GLX COUPLINGS
PCTS THERMOPLASTIC COUPLINGS
POLARSEAL COUPLINGS (ACA)
POLARSEAL II COUPLINGS (ACC)
POLARSEAL II COUPLINGS (ACB)
POWER STEERING
ADAPTERS
QUICK DISCONNECT COUPLERS
BALL VALVES
LIVE SWIVEL
ASSEMBLY FABRICATION
ACCESSORIES
EQUIPMENT AND PARTS
KITS
AIR BRAKE HOSE ASSY
BRASS

## COUPLING IDENTIFICATION



EQUIPMENT
HOSE/CPLG. SELECTION
G8K COUPLINGS
GLOBAL SPIRAL COUPLINGS
STAINLESS STEEL SPIRAL
MEGACRIMP COUPLINGS
STAINLESS STEEL BRAID
POWER CRIMP COUPLINGS
FIELD ATTACHABLE G1 & G2 COUPLINGS
FIELD ATTACHABLE C5 COUPLINGS
C14 COUPLINGS
GL COUPLINGS
GLX COUPLINGS
PCTS THERMOPLASTIC COUPLINGS
POLARSEAL COUPLINGS (ACA)
POLARSEAL II COUPLINGS (ACC)
POLARSEAL II COUPLINGS (ACB)
POWER STEERING
ADAPTERS
QUICK DISCONNECT COUPLERS
BALL VALVES
LIVE SWIVEL
ASSEMBLY FABRICATION
ACCESSORIES
EQUIPMENT AND PARTS
KITS
AIR BRAKE HOSE ASSY
BRASS

This section lists the origin and coupling style found in each country. Brief descriptions and dimensional data follows each coupling style.

There are five coupling systems generally used for hydraulic connections today.

They are identified geographically or by country as:

- North American**
- British**
- French**
- German**
- Japanese**

## NORTH AMERICAN THREAD TYPES

### Iron Pipe Thread Abbreviations

- N** National
- S** Straight Thread
- F** Fuels
- P** Pipe
- T** Tapered Thread
- M** Mechanical Joint

### NPTF

National Pipe Tapered thread for Fuel is a dryseal thread. It is used for both male and female ends. The NPTF male will mate with the NPTF, NPSF, or NPSM female.

The NPTF male has tapered threads and a 30° inverted seat. The NPTF female has tapered threads and no seat. The seal takes place by deformation of the threads. The NPSM female has straight threads and a 30° inverted seat. The seal takes place on the 30° seat.

The NPTF connector is similar to, but not interchangeable with, the BSPT connector. The thread pitch is different in most sizes. Also, the thread angle is 60° instead of the 55° angle found on BSPT threads.

Dash Size	Nominal Size (in)	No. Threads per Inch	Female Thread	Male Thread	Max. Torque Recommendation for Dry NPTF* (ft-lb)
			I.D. (in)	O.D. (in)	
-2	1/8	27	23/64	13/32	20
-4	1/4	18	15/32	35/64	25
-6	3/8	18	19/32	43/64	35
-8	1/2	14	3/4	27/32	45
-12	3/4	14	61/64	1-1/16	55
-16	1	11-1/2	1-13/64	1-5/16	65
-20	1-1/4	11-1/2	1-17/32	1-43/64	80
-24	1-1/2	11-1/2	1-25/32	1-29/32	95
-32	2	11-1/2	2-1/4	2-3/8	120

### NPT Pipe Thread

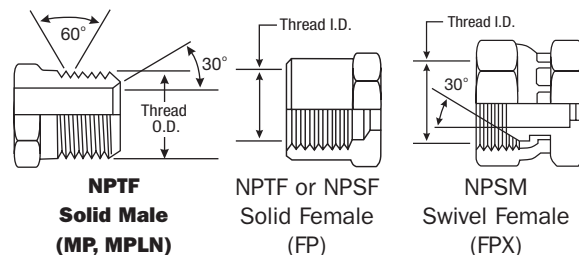

### NPSF

National Pipe Straight thread for Fuels is sometimes used for female ends and properly mates with the NPTF male end. However, SAE recommends the NPTF thread in preference to the NPSF for female ends.

### NPSM

National Pipe Straight thread for Mechanical Joint is used on the female swivel nut of iron pipe swivel adapters. The leak-resistant joint is not made by the sealing fit of threads, but by a tapered seat in the coupling end.

#### \*NOTES:

- Torque values can vary considerably depending on thread condition. Use only enough torque to achieve adequate sealing.
- With female straight or parallel pipe threads (NPSM), maximum values are 50 percent of those listed in the table.
- If thread sealant is used, maximum values shown should be decreased by 25 percent.



## NORTH AMERICAN THREAD TYPES – Continued

### \*JIC (37° Flare)

The Society of Automotive Engineers (SAE) specifies a 37° angle flare or seat be used with high pressure hydraulic tubing. These are commonly called JIC couplings.

The JIC 37° flare male will mate with a JIC female only.\*  
 The JIC male has straight threads and a 37° flare seat.  
 The JIC female has straight threads and a 37° flare seat.  
 The seal is made on the 37° flare seat.

Some sizes have the same threads as the SAE 45° flare. Carefully measure the seat angle to differentiate.

**\*Note:** Some C5, C5E and Lock-On couplings may have dual machined seats (both 37° and 45° seats).

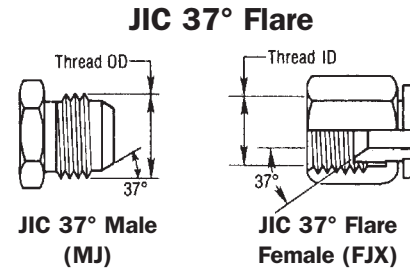

Dash Size	Nominal Size (in)	Thread Size	Female Thread	Male Thread	Steel Torque Recommendation (ft-lb)		Steel Torque Recommendation (N·m)	
			I.D. (in)	O.D. (in)	Assembly Torque* +25%-0 ft-lb	Assembly Torque Max. ft-lb	Assembly Torque* +25%-0 N·m	Assembly Torque Max. N·m
-2	1/8	5/16 - 24	17/64	5/16	-	-	-	-
-3	3/16	3/8 - 24	21/64	3/8	-	-	-	-
-4	1/4	7/16 - 20	25/64	7/16	11	14	15	19
-5	5/16	1/2 - 20	29/64	1/2	14	18	19	24
-6	3/8	9/16 - 18	1/2	9/16	18	22	24	30
-8	1/2	3/4 - 16	11/16	3/4	36	45	49	61
-10	5/8	7/8 - 14	13/16	7/8	57	71	77	96
-12	3/4	1-1/16 - 12	31/32	1-1/16	79	99	107	134
-14	7/8	1-3/16 - 12	1-7/64	1-3/16	-	-	-	-
-16	1	1-5/16 - 12	1-15/64	1-5/16	108	135	147	184
-20	1-1/4	1-5/8 - 12	1-35/64	1-5/8	127	158	172	215
-24	1-1/2	1-7/8 - 12	1-51/64	1-7/8	158	198	215	269
-32	2	2-1/2 - 12	2-27/64	2-1/2	245	306	332	415

\* Values from SAE J2593 FEB2015

**Over torque of hydraulic couplings can damage mating surfaces and is a leading cause of premature leaks.**

EQUIPMENT
HOSE/CPLG. SELECTION
G8K COUPLINGS
GLOBALSPIRAL COUPLINGS
STAINLESS STEEL SPIRAL
MEGACRIMP COUPLINGS
STAINLESS STEEL BRAID
POWER CRIMP COUPLINGS
FIELD ATTACHABLE G1 & G2 COUPLINGS
FIELD ATTACHABLE C5 COUPLINGS
C14 COUPLINGS
GL COUPLINGS
GLX COUPLINGS
PCTS THERMOPLASTIC COUPLINGS
POLARSEAL COUPLINGS (ACA)
POLARSEAL II COUPLINGS (ACC)
POLARSEAL II COUPLINGS (ACB)
POWER STEERING
ADAPTERS
QUICK DISCONNECT COUPLERS
BALL VALVES
LIVE SWIVEL
ASSEMBLY FABRICATION
ACCESSORIES
EQUIPMENT AND PARTS
KITS
AIR BRAKE HOSE ASSY
BRASS



## NORTH AMERICAN THREAD TYPES – Continued

EQUIPMENT
<b>HOSE/CPLG. SELECTION</b>
G8K COUPLINGS
GLOBALSPIRAL COUPLINGS
STAINLESS STEEL SPIRAL
MEGACRIMP COUPLINGS
STAINLESS STEEL BRAID
POWER CRIMP COUPLINGS
FIELD ATTACHABLE G1 & G2 COUPLINGS
FIELD ATTACHABLE C5 COUPLINGS
C14 COUPLINGS
GL COUPLINGS
GLX COUPLINGS
PCTS THERMOPLASTIC COUPLINGS
POLARSEAL COUPLINGS (ACA)
POLARSEAL II COUPLINGS (ACC)
POLARSEAL II COUPLINGS (ACB)
POWER STEERING
ADAPTERS
QUICK DISCONNECT COUPLERS
BALL VALVES
LIVE SWIVEL
ASSEMBLY FABRICATION
ACCESSORIES
EQUIPMENT AND PARTS
KITS
AIR BRAKE HOSE ASSY
BRASS

### \*SAE (45° Flare)

A term usually applied to fittings having a 45° angle flare or seat. Soft copper tubing is generally used in such applications as it is easily flared to the 45° angle. These are for low-pressure applications—such as for fuel lines and refrigerant lines.

The SAE 45° flare male will mate with an SAE 45° flare female only or a dual seat JIC/SAE 45°.\*

The SAE male has straight threads and a 45° flare seat. The SAE female has straight threads and a 45° flare seat. The seal is made on the 45° flare seat.

Some sizes have the same threads as the JIC 37° flare. Carefully measure the seat angle to differentiate.

**\*Note:** Some C5, C5E and Lock-On couplings may have dual machined seats (both 37° and 45° seats).

### SAE 45° Flare

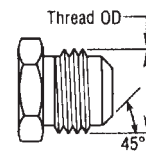

**SAE 45° Flare Male (MS)**

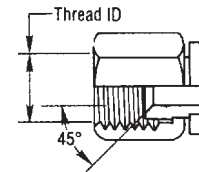

**SAE 45° Flare Swivel Female (FSX)**

Dash Size	Nominal Size (in)	Thread Size	Female Thread	Male Thread	Steel Torque Recommendation (ft-lb)		Steel Torque Recommendation (N-m)	
			I.D. (in)	O.D. (in)	Assembly Torque* +25%-0 ft-lb	Assembly Torque Max. ft-lb	Assembly Torque* +25%-0 N-m	Assembly Torque Max. N-m
-2	1/8	5/16 - 24	17/64	5/16	-	-	-	-
-3	3/16	3/8 - 24	21/64	3/8	-	-	-	-
-4	1/4	7/16 - 20	25/64	7/16	11	14	15	19
-5	5/16	1/2 - 20	29/64	1/2	14	18	19	24
-6	3/8	9/16 - 18	1/2	9/16	18	22	24	30
-8	1/2	3/4 - 16	11/16	3/4	36	45	49	61
-10	5/8	7/8 - 14	13/16	7/8	57	71	77	96
-12	3/4	1-1/16 - 12	31/32	1-1/16	79	99	107	134

\* Values from SAE J2593 FEB2015

Dash Size	Nominal Size (in)	Thread Size	Female Thread	Male Thread
			I.D. (in)	O.D. (in)
-6	3/8	11/16 - 18	5/8	11/16



## NORTH AMERICAN THREAD TYPES – Continued

### O-Ring Boss

The o-ring boss male will mate with an o-ring boss female only. The female is generally found on ports.

The male has straight threads, a sealing face and an o-ring. The female has straight threads and a sealing face.

The seal is made at the o-ring on the male and the sealing face on the female.

### SAE Straight Thread O-Ring Boss

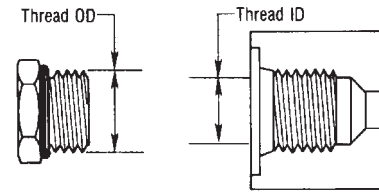

**O-Ring Boss Male (MB, MBX)**

**O-Ring Boss Female Port (FB)**

Dash Size	Nominal Size (in)	Thread Size	Female Thread	Male Thread	O-Ring	
			I.D. (in)	O.D. (in)	I.D. (in)	DESCR
-2	1/8	5/16 - 24	17/64	5/16	0.239	-
-3	3/16	3/8 - 24	21/64	3/8	0.301	30R
-4	1/4	7/16 - 20	25/64	7/16	0.351	40R
-5	5/16	1/2 - 20	29/64	1/2	0.414	50R
-6	3/8	9/16 - 18	1/2	9/16	0.468	60R
-8	1/2	3/4 - 16	11/16	3/4	0.644	80R
-10	5/8	7/8 - 14	13/16	7/8	0.755	100R
-12	3/4	1-1/16 - 12	31/32	1-1/16	0.924	120R
-14	7/8	1-3/16 - 12	1-7/64	1-3/16	1.048	140R
-16	1	1-5/16 - 12	1-15/64	1-5/16	1.171	160R
-20	1-1/4	1-5/8 - 12	1-35/64	1-5/8	1.475	200R
-24	1-1/2	1-7/8 - 12	1-51/64	1-7/8	1.720	-
-32	2	2-1/2 - 12	2-27/64	2-1/2	2.337	-

### O-Ring Boss Light-Duty - SAE J1926-3

Dash Size	Assembly Torque* +25%-0 ft-lb	Assembly Torque Max. ft-lb	Assembly Torque* +25%-0 N-m	Assembly Torque Max. N-m
-2	6	7	8	10
-3	7	9	10	13
-4	13	17	18	23
-5	18	23	25	31
-6	22	28	30	38
-8	37	46	50	63
-10	44	55	60	75
-12	70	88	95	119
-14	92	115	125	156
-16	111	138	150	188
-20	147	184	200	250
-24	155	193	210	263
-32	221	276	300	375
-40	221	276	300	375
-48	258	322	350	438
-64	258	322	350	438

\* Values from SAE J2593 FEB2015

### O-Ring Boss Heavy-Duty - SAE J1926-2

Dash Size	Assembly Torque* +25%-0 ft-lb	Assembly Torque Max. ft-lb	Assembly Torque* +25%-0 N-m	Assembly Torque Max. N-m
-3	7	9	10	13
-4	15	18	20	25
-5	18	23	25	31
-6	26	32	35	44
-8	52	64	70	88
-10	74	92	100	125
-12	125	157	170	213
-14	158	198	215	269
-16	199	249	270	338
-20	210	263	285	356
-24	273	341	370	463
-32	398	497	540	675
-40	398	497	540	675
-48	472	590	640	800

\* Values from SAE J2593 FEB2015

EQUIPMENT
HOSE/CPLG. SELECTION
G8K COUPLINGS
GLOBALSPIRAL COUPLINGS
STAINLESS STEEL SPIRAL
MEGACRIMP COUPLINGS
STAINLESS STEEL BRAID
POWER CRIMP COUPLINGS
FIELD ATTACHABLE G1 & G2 COUPLINGS
FIELD ATTACHABLE C5 COUPLINGS
C14 COUPLINGS
GL COUPLINGS
GLX COUPLINGS
PCTS THERMOPLASTIC COUPLINGS
POLARSEAL COUPLINGS (ACA)
POLARSEAL II COUPLINGS (ACC)
POLARSEAL II COUPLINGS (ACB)
POWER STEERING
ADAPTERS
QUICK DISCONNECT COUPLERS
BALL VALVES
LIVE SWIVEL
ASSEMBLY FABRICATION
ACCESSORIES
EQUIPMENT AND PARTS
KITS
AIR BRAKE HOSE ASSY
BRASS





# NORTH AMERICAN THREAD TYPES – Continued

EQUIPMENT
HOSE/CPLG. SELECTION
G8K COUPLINGS
GLOBAL SPIRAL COUPLINGS
STAINLESS STEEL SPIRAL
MEGACRIMP COUPLINGS
STAINLESS STEEL BRAID
POWER CRIMP COUPLINGS
FIELD ATTACHABLE G1 & G2 COUPLINGS
FIELD ATTACHABLE C5 COUPLINGS
C14 COUPLINGS
GL COUPLINGS
GLX COUPLINGS
PCTS THERMOPLASTIC COUPLINGS
POLARSEAL COUPLINGS (ACA)
POLARSEAL II COUPLINGS (ACC)
POLARSEAL II COUPLINGS (ACB)
POWER STEERING
ADAPTERS
QUICK DISCONNECT COUPLERS
BALL VALVES
LIVE SWIVEL
ASSEMBLY FABRICATION
ACCESSORIES
EQUIPMENT AND PARTS
KITS
AIR BRAKE HOSE ASSY
BRASS

## O-Ring Flange—SAE J518

The SAE Code 61 and Code 62 4-bolt split flange is used worldwide, usually as a connection on pumps and motors. There are three exceptions.

1. The -10 size, which is common outside of North America, is not an SAE standard size (generally found on Komatsu equipment). All Komatsu flanges are the same as SAE code 61 except for the -10 size.
2. Caterpillar flanges, which are the same flange O.D. as SAE Code 62, have a thicker flange head ("C" dimension in Table).
3. Poclain flanges, which are completely different from SAE flanges.

### SAE Code 61 and Code 62

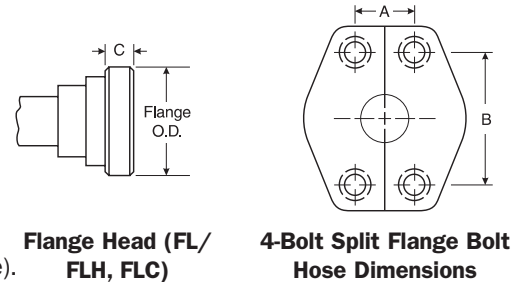

Flange Head (FL/ FLH, FLC)

4-Bolt Split Flange Bolt Hose Dimensions

### Code 61 Inch Screw - SAE J518-1

Dash Size	Assembly Torque* +10%-0 ft-lb	Assembly Torque Max. ft-lb	Assembly Torque* +10%-0 N-m	Assembly Torque Max. N-m
-8	24	29	32	40
-12	44	55	60	75
-16	44	55	60	75
-20	68	85	92	115
-24	111	138	150	188
-32	111	138	150	188
-40	111	138	150	188
-48	217	272	295	369
-56	217	272	295	369
-64	217	272	295	369
-80	217	272	295	369

\* Values from SAE J2593 FEB2015

### Code 61 Metric Screw - SAE J518-1

Dash Size	Assembly Torque* +10%-0 ft-lb	Assembly Torque Max. ft-lb	Assembly Torque* +10%-0 N-m	Assembly Torque Max. N-m
-8	24	29	32	40
-12	52	64	70	88
-16	52	64	70	88
-20	52	64	70	88
-24	96	120	130	163
-32	96	120	130	163
-40	96	120	130	163
-48	217	272	295	369
-56	217	272	295	369
-64	217	272	295	369
-80	217	272	295	369

\* Values from SAE J2593 FEB2015

### Code 62 Inch Screw - SAE J518-2

Dash Size	Assembly Torque* +10%-0 ft-lb	Assembly Torque Max. ft-lb	Assembly Torque* +10%-0 N-m	Assembly Torque Max. N-m
-8	24	29	32	40
-12	44	55	60	75
-16	68	85	92	115
-20	111	138	150	188
-24	217	272	295	369
-32	332	415	450	563

\* Values from SAE J2593 FEB2015

### Code 62 Metric Screw - SAE J518-2

Dash Size	Assembly Torque* +10%-0 ft-lb	Assembly Torque Max. ft-lb	Assembly Torque* +10%-0 N-m	Assembly Torque Max. N-m
-8	24	29	32	40
-12	52	64	70	88
-16	96	120	130	163
-20	96	120	130	163
-24	217	272	295	369
-32	405	507	550	688

\* Values from SAE J2593 FEB2015

### Caterpillar Code 62 (FLC)

Dash Size	Flange O.D. (in)	A (in)	B (in)	C (in)
-12	1.625	.938	2.000	.560
-16	1.875	1.094	2.250	.560
-20	2.125	1.250	2.625	.560
-24	2.500	1.438	3.125	.560
-32	3.125	1.750	3.812	.560



## NORTH AMERICAN THREAD TYPES – Continued

### O-Ring Face Seal (ORFS)—SAE J1453

A seal is made when the o-ring in the male contacts the flat face on the female. Couplings are intended for hydraulic systems where elastomeric seals are acceptable to overcome leakage and leak resistance is crucial.

The solid male o-ring face seal fitting will mate with a swivel female o-ring face seal SAE J1453 fitting only.

An o-ring rests in the o-ring groove in the male.

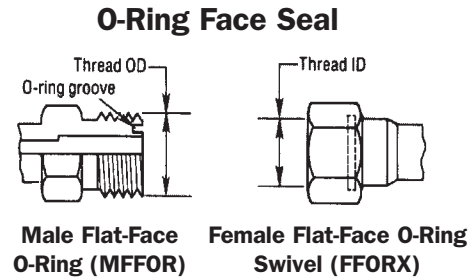

Dash Size	Nominal Size (in)	Thread Size	Thread		Assembly Torque* +25%-0 ft-lb	Assembly Torque Max. ft-lb	Assembly Torque* +25%-0 N-m	Assembly Torque Max. N-m	O-Ring Size
			I.D. (in)	O.D. (in)					
-4	1/4	9/16 - 18	1/2	9/16	18	23	25	31	-011
-6	3/8	11/16 - 16	5/8	11/16	29	37	40	50	-012
-8	1/2	13/16 - 16	3/4	13/16	41	51	55	69	-014
-10	5/8	1 - 14	15/16	1	44	55	60	75	-016
-12	3/4	1-3/16 - 12	1-1/8	1-3/16	66	83	90	113	-018
-16	1	1-7/16 - 12	1-11/32	1-7/16	92	115	125	156	-021
-20	1-1/4	1-11/16 - 12	1-19/32	1-11/16	125	157	170	213	-025
-24	1-1/2	2 - 12	1-29/32	2	147	184	200	250	-029
-32	2	2-1/2 - 12	-	-	376	470	510	638	-

\* Values from SAE J2593 FEB2015

EQUIPMENT
HOSE/CPLG. SELECTION
G8K COUPLINGS
GLOBALSPIRAL COUPLINGS
STAINLESS STEEL SPIRAL
MEGACRIMP COUPLINGS
STAINLESS STEEL BRAID
POWER CRIMP COUPLINGS
FIELD ATTACHABLE G1 & G2 COUPLINGS
FIELD ATTACHABLE C5 COUPLINGS
C14 COUPLINGS
GL COUPLINGS
GLX COUPLINGS
PCTS THERMOPLASTIC COUPLINGS
POLARSEAL COUPLINGS (ACA)
POLARSEAL II COUPLINGS (ACC)
POLARSEAL II COUPLINGS (ACB)
POWER STEERING
ADAPTERS
QUICK DISCONNECT COUPLERS
BALL VALVES
LIVE SWIVEL
ASSEMBLY FABRICATION
ACCESSORIES
EQUIPMENT AND PARTS
KITS
AIR BRAKE HOSE ASSY
BRASS



## NORTH AMERICAN THREAD TYPES – Continued

EQUIPMENT
HOSE/CPLG. SELECTION
G8K COUPLINGS
GLOBAL SPIRAL COUPLINGS
STAINLESS STEEL SPIRAL
MEGACRIMP COUPLINGS
STAINLESS STEEL BRAID
POWER CRIMP COUPLINGS
FIELD ATTACHABLE G1 & G2 COUPLINGS
FIELD ATTACHABLE C5 COUPLINGS
C14 COUPLINGS
GL COUPLINGS
GLX COUPLINGS
PCTS THERMOPLASTIC COUPLINGS
POLARSEAL COUPLINGS (ACA)
POLARSEAL II COUPLINGS (ACC)
POLARSEAL II COUPLINGS (ACB)
POWER STEERING
ADAPTERS
QUICK DISCONNECT COUPLERS
BALL VALVES
LIVE SWIVEL
ASSEMBLY FABRICATION
ACCESSORIES
EQUIPMENT AND PARTS
KITS
AIR BRAKE HOSE ASSY
BRASS

### Flareless Tube

The flareless solid male will mate with a female flareless nut and compression sleeve only.

The male has straight threads and a 24° seat. The female has straight threads and has a compression sleeve for a sealing surface. The seal is made between the compression sleeve and the 24° seat on the male, and between the compression sleeve and the tubing on the female.

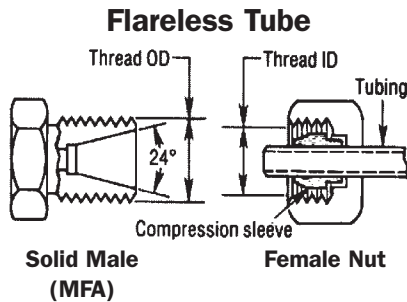

Dash Size	Tube Size (in)	Nominal Size (in)	Thread Size	Female Thread	Male Thread
				I.D. (in)	O.D. (in)
-2	1/8	5/16	5/16 - 24	17/64	5/16
-3	3/16	3/8	3/8 - 24	21/64	3/8
-4	1/4	7/16	7/16 - 20	25/64	7/16
-5	5/16	1/2	1/2 - 20	29/64	1/2
-6	3/8	9/16	9/16 - 18	1/2	9/16
-8	1/2	3/4	3/4 - 16	11/16	3/4
-10	5/8	7/8	7/8 - 14	13/16	7/8
-12	3/4	1-1/16	1-1/16 - 12	31/32	1-1/16
-14	7/8	1-3/16	1-3/16 - 12	1-7/64	1-3/16
-16	1	1-5/16	1-5/16 - 12	1-15/64	1-5/16
-20	1-1/4	1-5/8	1-5/8 - 12	1-35/64	1-5/8
-24	1-1/2	1-7/8	1-7/8 - 12	1-51/64	1-7/8
-32	2	2-1/2	2-1/2 - 12	2-27/64	2-1/2

### North American Stand Pipe (NASP)

A stand pipe assembly is comprised of three components attached to a male fitting. The components are a Stand Pipe Tube, Bite Sleeve and Nut. The Nut is placed over the Stand Pipe, followed by the Bite Sleeve (see illustration below). The Bite Sleeve and Stand Pipe are selected on the basis of tube O.D. required.

Dash Size	Tube O.D. (in)	Tube Length (in)
-4	1/4	0.88
-6	3/8	0.88
-8	1/2	1.00
-12	3/4	1.16
-16	1	1.12

#### North American Stand Pipe

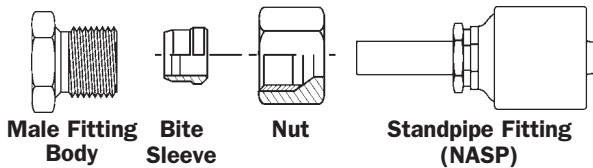

### SAE Inverted Flare

The SAE 45° inverted flare male will mate with an SAE 42° inverted flare female only.

The male has straight threads and a 45° inverted flare. The female has straight threads and a 42° inverted flare. The seal is made on the 45° flare seat on the male and the 42° flare seat on the female.

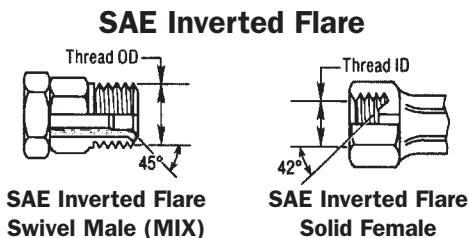

Dash Size	Nominal Size (in)	Thread Size	Female Thread	Male Thread
			I.D. (in)	O.D. (in)
-2	1/8	5/16 - 28	9/32	5/16
-3	3/16	3/8 - 24	21/64	3/8
-4	1/4	7/16 - 24	25/64	7/16
-5	5/16	1/2 - 20	29/64	1/2
-6	3/8	5/8 - 18	37/64	5/8
-7	7/16	11/16 - 18	5/8	11/16
-8	1/2	3/4 - 18	45/64	3/4
-10	5/8	7/8 - 18	13/16	7/8
-12	3/4	1-1/16 - 16	1	1-1/16



## NORTH AMERICAN THREAD TYPES – Continued

### Air Brake Fittings

Female air brake swivels are designed to work exclusively with a male air brake adapter. Federal law requires only this combination to be used on air brake lines from the valve to the air brake diaphragm chamber.

The male has straight threads and an inverted seat. The female has straight threads and a corresponding inverted flare. The seal is made on the flare seats of both the male and female.

Dash Size	Thread Size	Female Thread I.D. (in)	Male Thread O.D. (in)
-6	3/4 - 20	23/32	3/4
-8	7/8 - 20	27/32	7/8

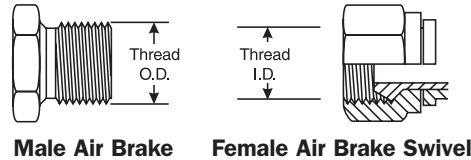

### Grease Fittings

#### Special Male Grease Fitting

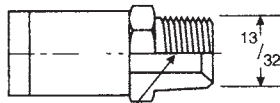

1/8-27 Pipe Thread

#### Special Female Grease Fitting

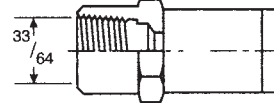

1/2-27 Tapered Thread

### Parker Triple Thread Flare Fittings

#### Parker Triple Thread Flare Fittings

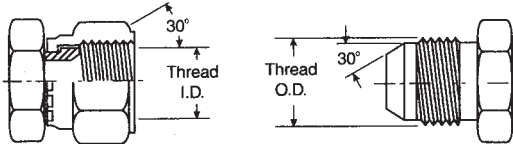

Swivel Female (FZX)

Solid Male (MZ)

Dash Size	Nominal Size (in)	Thread Size	Female Thread	Male Thread
			I.D. (in)	O.D. (in)
-16	1-5/16	1-5/16 - 14	1-1/4	1-5/16

EQUIPMENT
HOSE/CPLG. SELECTION
G8K COUPLINGS
GLOBALSPIRAL COUPLINGS
STAINLESS STEEL SPIRAL
MEGACRIMP COUPLINGS
STAINLESS STEEL BRAID
POWER CRIMP COUPLINGS
FIELD ATTACHABLE G1 & G2 COUPLINGS
FIELD ATTACHABLE C5 COUPLINGS
C14 COUPLINGS
GL COUPLINGS
GLX COUPLINGS
PCTS THERMOPLASTIC COUPLINGS
POLARSEAL COUPLINGS (ACA)
POLARSEAL II COUPLINGS (ACC)
POLARSEAL II COUPLINGS (ACB)
POWER STEERING
ADAPTERS
QUICK DISCONNECT COUPLERS
BALL VALVES
LIVE SWIVEL
ASSEMBLY FABRICATION
ACCESSORIES
EQUIPMENT AND PARTS
KITS
AIR BRAKE HOSE ASSY
BRASS



EQUIPMENT
HOSE/CPLG. SELECTION
G8K COUPLINGS
GLOBAL SPIRAL COUPLINGS
STAINLESS STEEL SPIRAL
MEGACRIMP COUPLINGS
STAINLESS STEEL BRAID
POWER CRIMP COUPLINGS
FIELD ATTACHABLE G1 & G2 COUPLINGS
FIELD ATTACHABLE C5 COUPLINGS
C14 COUPLINGS
GL COUPLINGS
GLX COUPLINGS
PCTS THERMOPLASTIC COUPLINGS
POLARSEAL COUPLINGS (ACA)
POLARSEAL II COUPLINGS (ACC)
POLARSEAL II COUPLINGS (ACB)
POWER STEERING
ADAPTERS
QUICK DISCONNECT COUPLERS
BALL VALVES
LIVE SWIVEL
ASSEMBLY FABRICATION
ACCESSORIES
EQUIPMENT AND PARTS
KITS
AIR BRAKE HOSE ASSY
BRASS

## Foreign Thread Types

### Identifying Foreign Couplings

If you can identify the country of origin of the equipment you are working with, it is easy to identify the coupling style. Simply find the appropriate country in the following pages and locate the particular coupling in the table that follows.

### Foreign Thread Types – British

It is a common misconception that all foreign threads are metric. This is not always the case. There are two common thread forms: Metric and Whitworth (BSP). The country of origin and the proper nomenclature for each is listed below.

#### British Standard Pipe Parallel

Popular couplings have British Standard Pipe (BSP) threads, also known as Whitworth threads. These can be parallel threads (BSPP) with a 30° inverted flare or tapered threads (BSPT), with a 30° inverted flare. Port connections are usually made with BSPP threads and a soft metal cutting ring for sealing. The BSPP (parallel) male will mate with a BSPOR (parallel) female or a female port.

The BSPP male has straight threads and a 30° seat. The BSPOR female has straight threads, a 30° seat, and o-ring. The female port has straight threads and a spotface. The seal on the port is made with an o-ring or soft metal washer on the male.

The BSPP (parallel) connector is similar to, but not interchangeable with, the NPSM connector. The thread pitch is different in most sizes, and the thread angle is 55° instead of the 60° angle found on NPSM threads.

Dash Size	Nominal Size (in)	Thread Size	Female Parallel Thread	Male Parallel Thread	Torque Recommendation (ft-lb)	
			I.D. (in)	O.D. (in)	Min.	Max.
-2	1/8	1/8 - 28	11/32	3/8	7	9
-4	1/4	1/4 - 19	15/32	17/32	11	18
-6	3/8	3/8 - 19	19/32	21/32	19	28
-8	1/2	1/2 - 14	3/4	13/16	30	36
-10	5/8	5/8 - 14	13/16	29/32	37	44
-12	3/4	3/4 - 14	31/32	1-1/32	50	60
-16	1	1 - 11	1-7/32	1-11/32	79	95
-20	1-1/4	1-1/4 - 11	1-17/32	1-21/32	127	152
-24	1-1/2	1-1/2 - 11	1-25/32	1-7/8	167	190
-32	2	2 - 11	2-7/32	2-11/32	262	314

#### British Standard Pipe Parallel (BSPOR)

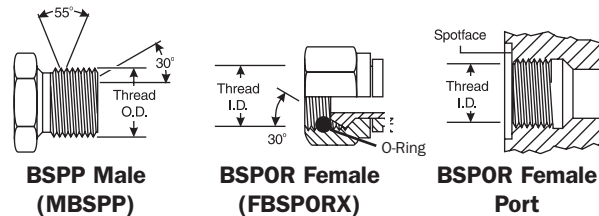

#### British Flat-Face Seal

A seal is made when the o-ring in the male contacts the flat face on the female. These couplings are intended for hydraulic systems where elastomeric seals are acceptable to overcome leakage and leak resistance is crucial.

The solid male British o-ring face seal fitting will mate with a swivel female British o-ring face seal fitting only. An o-ring rests in the o-ring groove in the male.

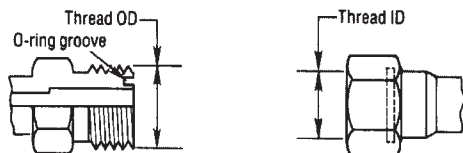

Male British Flat-Face (MBFF) Female British Flat-Face (FBFF)

Dash Size	Nominal Size (in)	Thread Size	Female Parallel Thread	Male Parallel Thread	Torque Recommendation (ft-lb)	
			I.D. (in)	O.D. (in)	Min.	Max.
-6	3/8	3/8-19	19/32	21/32	18	20
-8	1/2	1/2-14	3/4	13/16	32	40
-10	5/8	5/8 - 14	-	-	-	-
-12	3/4	3/4-14	31/32	1 1/32	65	80
-16	1	1 - 11	-	-	-	-



## Foreign Thread Types – British – Continued

### British Standard Pipe Tapered

The BSPT (tapered) male will mate with a BSPT (tapered) female, or a BSPOR (parallel) female.

The BSPT male has tapered threads. When mating with either the BSPT (tapered) female or the BSPOR (parallel) female port, the seal is made on the threads.

The BSPT connector is similar to, but not interchangeable with, the NPTF connector. The thread pitch is different in most cases, and the thread angle is 55° instead of the 60° angle found on NPTF threads.

#### British Standard Pipe Tapered (BSPT)

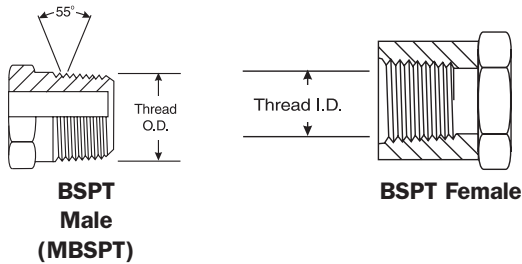

Dash Size	Nominal Size (in)	Thread Size	Female Tapered Thread	Male Tapered Thread	Torque Recommendation (ft-lb)	
			I.D. (in)	O.D. (in)	Min.	Max.
-2	1/8	1/8 - 28	11/32	3/8	7	9
-4	1/4	1/4 - 19	15/32	17/32	11	18
-6	3/8	3/8 - 19	19/32	21/32	19	28
-8	1/2	1/2 - 14	3/4	13/16	30	36
-10	5/8	5/8 - 14	13/16	29/32	37	44
-12	3/4	3/4 - 14	31/32	1-1/32	50	60
-16	1	1 - 11	1-7/32	1-11/32	79	95
-20	1-1/4	1-1/4 - 11	1-17/32	1-21/32	127	152
-24	1-1/2	1-1/2 - 11	1-25/32	1-7/8	167	190
-32	2	2 - 11	2-7/32	2-11/32	262	314

## Foreign Thread Types – French

Popular couplings are French GAZ. These have a 24° seat and metric threads. These are similar to German DIN couplings, but the threads are different in some sizes. Although both are metric threads, the French use fine threads in all sizes and German DIN couplings use coarse threads in larger sizes. Most port connections are flange connections. French flanges are different than SAE—they have a lip that protrudes from the flange face. These are called Poclairn-style flanges.

### GAZ 24°

The French Metric (GAZ) male will mate with the female 24° cone or the female tube fitting.

The male has a 24° seat and straight metric threads. The female has a 24° seat or a tubing sleeve and straight metric threads and is interchangeable with female Kobelco.

When measuring the flare angle with the seat angle gauge, use the 12° gauge. The seat angle gauge measures the angle from the connector centerline.

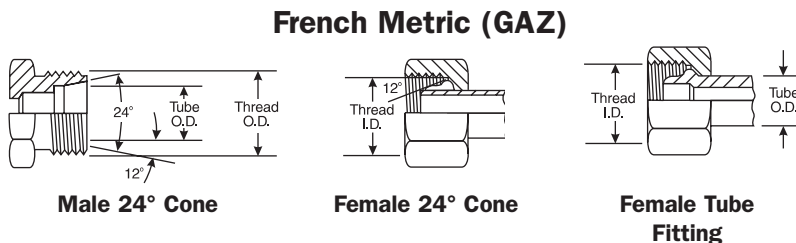

Metric Thread Size	Female Thread I.D. (mm)	Male Thread O.D. (mm)	Tube O.D. (mm)
M20x1.5	18.5	20.0	13.25
M24x1.5	22.5	24.0	16.75
M30x1.5	28.5	30.0	21.25
M36x1.5	34.5	36.0	26.75
M45x1.5	43.5	45.0	33.50
M52x1.5	50.5	52.0	42.25

EQUIPMENT
HOSE/CPLG. SELECTION
G8K COUPLINGS
GLOBALSPIRAL COUPLINGS
STAINLESS STEEL SPIRAL
MEGACRIMP COUPLINGS
STAINLESS STEEL BRAID
POWER CRIMP COUPLINGS
FIELD ATTACHABLE G1 & G2 COUPLINGS
FIELD ATTACHABLE C5 COUPLINGS
C14 COUPLINGS
GL COUPLINGS
GLX COUPLINGS
PCTS THERMOPLASTIC COUPLINGS
POLARSEAL COUPLINGS (ACA)
POLARSEAL II COUPLINGS (ACC)
POLARSEAL II COUPLINGS (ACB)
POWER STEERING
ADAPTERS
QUICK DISCONNECT COUPLERS
BALL VALVES
LIVE SWIVEL
ASSEMBLY FABRICATION
ACCESSORIES
EQUIPMENT AND PARTS
KITS
AIR BRAKE HOSE ASSY
BRASS





## Foreign Thread Types – French – Continued

### GAZ Poclairn 24° Flange

The Poclairn (French GAZ) 24° high pressure flange is usually found on Poclairn equipment.

The male flange will mate with a female flange or port. The seal is made on the 24° seat.

Nominal Size (in)	A (in)	B (in)	C (in)	D (in)	E (in)	F (in)
1/2	1.57	.72	2.20	1.89	.55	.35
5/8	1.57	.72	2.20	1.89	.55	.35
3/4	2.00	.94	2.75	2.38	.71	.43

#### Poclairn (French GAZ)

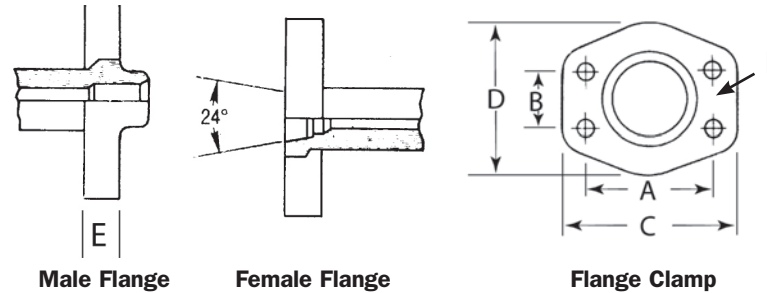

## Foreign Thread Types – German DIN (Deutsche Industrial Norme)

Popular couplings are German DIN (Deutsche Industrial Norme). A coupling referred to as “metric” usually means a DIN coupling.

### DIN 24° Cone

The DIN 24° cone male will mate with any of the females shown.

The male has a 24° seat, straight metric threads, and a recessed counterbore which matches the tube O.D. of the coupling used with it. The mating female is a 24° cone with o-ring, a metric tube fitting or a universal 24° and 60° cone. There is a light and heavy series DIN coupling. Proper identification is made by measuring both the thread size and the tube O.D. (The heavy series has a smaller tube O.D. but a thicker wall section than the light.)

When measuring the flare angle with the seat angle gauge, use the 12° gauge. The seat angle gauge measures the angle from the connector centerline.

Metric Thread Size	Female Thread		Male Thread		Tube O.D.		Torque Recommendation (ft-lb)	
	I.D. (mm)	O.D. (mm)	Light Series (mm)	Heavy Series (mm)	Min.	Max.	Min.	Max.
M12x1.5	10.5	12.0	6	—	7	15		
M14x1.5	12.5	14.0	8	—	15	26		
M16x1.5	14.5	16.0	10	8	18	30		
M18x1.5	16.5	18.0	12	10	22	33		
M20x1.5	18.5	20.0	14	12	26	37		
M22x1.5	20.5	22.0	15	14	30	52		
M24x1.5	22.5	24.0	—	16	30	52		
M26x1.5	24.5	26.0	18	—	44	74		
M30x2.0	28.0	30.0	22	20	59	89		
M36x2.0	34.0	36.0	28	25	74	111		
M42x2.0	40.0	42.0	—	30	74	162		
M45x2.0	43.0	45.0	35	—	133	184		
M52x2.0	50.0	52.0	42	38	148	221		

#### DIN 24° Male and Mating Females

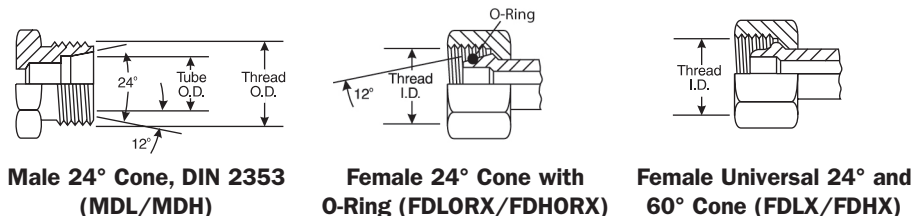

Male 24° Cone, DIN 2353 (MDL/MDH)

Female 24° Cone with O-Ring (FDLORX/FDHORX)

Female Universal 24° and 60° Cone (FDLX/FDHX)



## Foreign Thread Types – German DIN – Continued

### DIN 60° Cone

The DIN 60° cone male will mate with the female universal 24° or 60° cone connector only.

The male has a 60° seat and straight metric threads. The female has a 24° and 60° universal seat and straight metric threads.

When measuring the flare angle with the seat angle gauge, use the 30° gauge. The seat angle gauge measures the angle from the connector centerline.

Metric Thread Size	Female Thread	Male Thread	Tube O.D. (mm)	Torque Recommendation (ft-lb)	
	I.D. (mm)	O.D. (mm)		Min.	Max.
M14x1.5	12.5	14.0	8	15	26
M16x1.5	14.5	16.0	10	18	30
M18x1.5	16.5	18.0	12	22	33
M22x1.5	20.5	22.0	15	30	52
M26x1.5	24.5	26.0	18	44	74
M30x1.5	28.5	30.0	22	59	59
M38x1.5	36.5	38.0	28	74	111
M45x1.5	43.5	45.0	35	133	184
M52x2.0	50.5	52.0	42	148	221

### DIN 60° Male and Mating Female

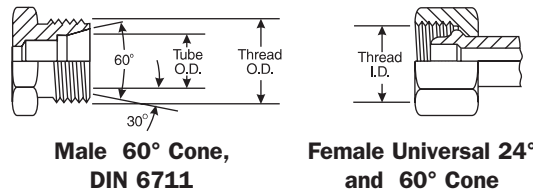

EQUIPMENT
HOSE/CPLG. SELECTION
G8K COUPLINGS
GLOBALSPIRAL COUPLINGS
STAINLESS STEEL SPIRAL
MEGACRIMP COUPLINGS
STAINLESS STEEL BRAID
POWER CRIMP COUPLINGS
FIELD ATTACHABLE G1 & G2 COUPLINGS
FIELD ATTACHABLE C5 COUPLINGS
C14 COUPLINGS
GL COUPLINGS
GLX COUPLINGS
PCTS THERMOPLASTIC COUPLINGS
POLARSEAL COUPLINGS (ACA)
POLARSEAL II COUPLINGS (ACC)
POLARSEAL II COUPLINGS (ACB)
POWER STEERING
ADAPTERS
QUICK DISCONNECT COUPLERS
BALL VALVES
LIVE SWIVEL
ASSEMBLY FABRICATION
ACCESSORIES
EQUIPMENT AND PARTS
KITS
AIR BRAKE HOSE ASSY
BRASS



## Foreign Thread Types – German DIN – Continued

EQUIPMENT
HOSE/CPLG. SELECTION
G8K COUPLINGS
GLOBAL SPIRAL COUPLINGS
STAINLESS STEEL SPIRAL
MEGACRIMP COUPLINGS
STAINLESS STEEL BRAID
POWER CRIMP COUPLINGS
FIELD ATTACHABLE G1 & G2 COUPLINGS
FIELD ATTACHABLE C5 COUPLINGS
C14 COUPLINGS
GL COUPLINGS
GLX COUPLINGS
PCTS THERMOPLASTIC COUPLINGS
POLARSEAL COUPLINGS (ACA)
POLARSEAL II COUPLINGS (ACC)
POLARSEAL II COUPLINGS (ACB)
POWER STEERING
ADAPTERS
QUICK DISCONNECT COUPLERS
BALL VALVES
LIVE SWIVEL
ASSEMBLY FABRICATION
ACCESSORIES
EQUIPMENT AND PARTS
KITS
AIR BRAKE HOSE ASSY
BRASS

### DIN 3852 Couplings Type A & B (Parallel Threads)

The male DIN 3852 Type A & B couplings will mate with the female DIN coupling shown below. Gates offers this thread as an adapter.

The male and female type A & B couplings have straight threads. The seal occurs when the ring seal (Type A) or the face seal (Type B) mates with the face of the female port.

There are two series of DIN 3852 Type A & B couplings, the light (L) and the heavy (S) series.

**Note:** Commonly used threads on male metric adapters.

### DIN 3852 Couplings Type A & B (Parallel Threads)

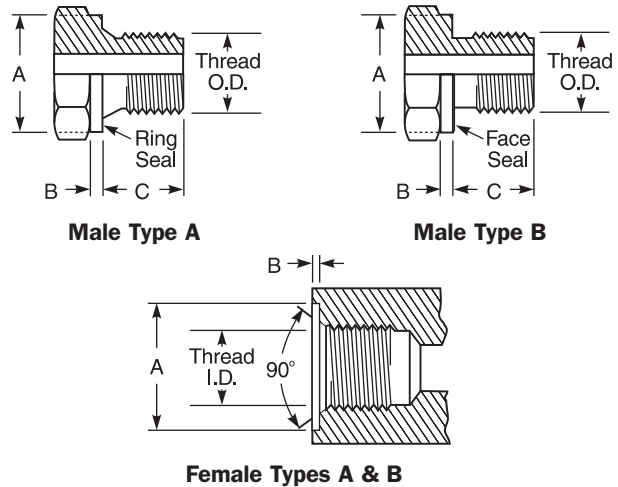

Series	Tube O.D. (mm)	Metric Thread Parallel								Whitworth Thread Parallel							
		Thread Size	Female			Male				Thread Size	Female (BSPOR)			Male (BSPP)			
			Thread I.D. (mm)	A (mm)	B (mm)	Thread O.D. (mm)	A (mm)	B (mm)	C (mm)		Thread I.D. (in)	A (mm)	B (mm)	Thread O.D. (in)	A (mm)	B (mm)	C (mm)
L Light	6	10x1.0	8.5	15	1.0	10	14	1.5	8	1/8-28	11/32	15	1.0	3/8	14	1.5	8
	8	12x1.5	10.5	18	1.5	12	17	2.0	12	1/4-19	15/32	19	1.5	1/2	17	2.0	12
	10	14x1.5	12.5	20	1.5	14	19	2.0	12	1/4-19	15/32	19	1.5	1/2	19	2.0	12
	12	16x1.5	14.5	22	1.5	16	21	2.5	12	3/8-19	19/32	23	2.0	21/32	21	2.5	12
	15	18x1.5	16.5	24	2.0	18	23	2.5	12	1/2-14	3/4	27	2.5	13/16	23	2.5	12
	18	22x1.5	20.5	28	2.5	22	27	3.0	14	1/2-14	3/4	27	2.5	13/16	27	3.0	14
	22	26x1.5	24.5	32	2.5	26	31	3.0	16	3/4-14	31/32	33	2.5	1-1/32	31	3.0	16
	28	33x2.0	31.5	40	2.5	33	39	3.0	18	1-11	1-7/32	40	2.5	1-5/16	39	3.0	18
	35	42x2.0	40.5	50	2.5	42	49	3.0	20	1-1/4-11	1-17/32	50	2.5	1-21/32	49	3.0	20
S Heavy	6	12x1.5	10.5	18	1.5	12	17	2.0	12	1/4-19	15/32	19	1.5	1/2	17	2.0	12
	8	14x1.5	12.5	20	1.5	14	19	2.0	12	1/4-19	15/32	19	1.5	1/2	19	2.0	12
	10	16x1.5	14.5	22	1.5	16	21	2.5	12	3/8-19	19/32	23	2.0	21/32	21	2.5	12
	12	18x1.5	16.5	24	2.0	18	23	2.5	12	3/8-19	19/32	23	2.0	21/32	23	2.5	12
	14	20x1.5	18.5	26	2.0	20	25	3.0	14	1/2-14	3/4	27	2.5	13/16	25	3.0	14
	16	22x1.5	20.5	28	2.5	22	27	3.0	14	1/2-14	3/4	27	2.5	13/16	27	3.0	14
	20	27x2.0	25.5	33	2.5	27	32	3.0	16	3/4-14	31/32	33	2.5	1-1/32	32	3.0	16
	25	33x2.0	31.5	40	2.5	33	39	3.0	18	1-11	1-7/32	40	2.5	1-5/16	39	3.0	18
	30	42x2.0	40.5	50	2.5	42	49	3.0	20	1-1/4-11	1-17/32	50	2.5	1-21/32	49	3.0	20
	38	48x2.0	46.5	56	2.5	48	55	3.0	22	1-1/2-11	1-25/32	56	2.5	1-7/8	55	3.0	22



## Foreign Thread Types – German DIN – Continued

### DIN 3852 Type C Metric and Whitworth Tapered (BSPT) Thread Connectors

The DIN 3852 Type C couplings are available with either metric or Whitworth British thread. The male will mate only with the female as shown.

The male and female couplings have tapered threads. The seal takes place on the threads. There are three series of DIN 3852 Type C Couplings: extra light (LL), light (L) and heavy (S).

### DIN 3852 Type C Metric and Whitworth Tapered Thread Connectors

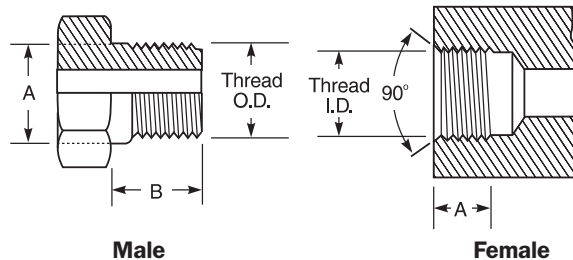

Series	Tube O.D. (mm)	Metric Tapered Threads						Whitworth Tapered Threads					
		Thread Size	Female		Male		Thread Size	Female		Male			
			Thread I.D. (mm)	A (mm)	Thread O.D. (mm)	A (mm)		B (mm)	Thread I.D. (in)	A (mm)	Thread O.D. (in)	A (mm)	B (mm)
LL	4	8x1.0	6.5	5.5	8	8.40	8	1/8-28	11/32	5.5	1/8	.392	8
	5	8x1.0	6.5	5.5	8	8.40	8	1/8-28	11/32	5.5	1/8	.392	8
	6	10x1.0	8.5	5.5	10	10.40	8	1/8-28	11/32	5.5	1/8	.392	8
L	8	10x1.0	8.5	5.5	10	10.40	8	1/8-28	11/32	5.5	1/8	.392	8
	6	10x1.0	8.5	5.5	10	10.40	8	1/8-28	11/32	5.5	1/8	.392	8
	8	12x1.5	10.5	8.5	12	12.53	12	1/4-19	15/32	8.5	1/4	.532	12
	10	14x1.5	12.5	8.5	14	14.53	12	1/4-19	15/32	8.5	1/4	.532	12
	12	16x1.5	14.5	8.5	16	16.53	12	3/8-19	19/32	8.5	3/8	.670	12
S Heavy	15	18x1.5	16.5	8.5	18	18.53	12	1/2-14	3/4	8.5	1/2	.839	14
	18	22x1.5	20.5	10.5	22	22.65	14	1/2-14	3/4	10.5	1/2	.839	14
	6	12x1.5	10.5	8.5	12	12.53	12	1/4-19	15/32	8.5	1/4	.532	12
	8	14x1.5	12.5	8.5	14	14.53	12	1/4-19	15/32	8.5	1/4	.532	12
	10	16x1.5	14.5	8.5	16	16.53	12	3/8-19	19/32	8.5	3/8	.670	12
S Heavy	12	18x1.5	16.5	8.5	18	18.53	12	3/8-19	19/32	8.5	3/8	.670	12
	14	20x1.5	18.5	10.5	20	20.65	14	1/2-14	3/4	10.5	1/2	.839	14
	16	22x1.5	20.5	10.5	22	22.65	14	1/2-14	3/4	10.5	1/2	.839	14

### Metric Stand Pipe Assembly

A metric stand pipe assembly is comprised of three components attached to a male fitting. The components are: a Stand Pipe Tube, Bite Sleeve and Metric Nut. The nut is placed over the Stand Pipe, followed by the Bite Sleeve (see illustration below). For DIN light assemblies, a DIN light metric nut is used. For DIN heavy assemblies, a DIN heavy metric nut is used. The Bite Sleeve and Stand Pipe are selected on the basis of tube O.D.

#### Metric Standpipe Assembly

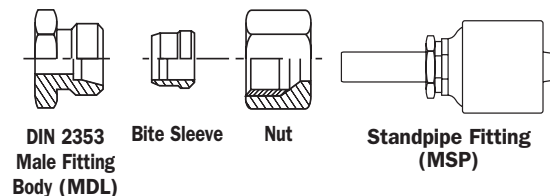

Metric Stand Pipe DIN Tube O.D. (mm)	Bite Sleeve DIN Tube O.D. (mm)	Metric Nut Thread
		Light
6	6	M12x1.5
8	8	M14x1.5
10	10	M16x1.5
12	12	M18x1.5
15	15	M22x1.5
18	18	M26x1.5
22	22	M30x2.0
28	28	M36x2.0
35	35	M45x2.0
42	42	M52x2.0

EQUIPMENT
HOSE/CPLG. SELECTION
G8K COUPLINGS
GLOBALSPIRAL COUPLINGS
STAINLESS STEEL SPIRAL
MEGACRIMP COUPLINGS
STAINLESS STEEL BRAID
POWER CRIMP COUPLINGS
FIELD ATTACHABLE G1 & G2 COUPLINGS
FIELD ATTACHABLE C5 COUPLINGS
C14 COUPLINGS
GL COUPLINGS
GLX COUPLINGS
PCTS THERMOPLASTIC COUPLINGS
POLARSEAL COUPLINGS (ACA)
POLARSEAL II COUPLINGS (ACC)
POLARSEAL II COUPLINGS (ACB)
POWER STEERING
ADAPTERS
QUICK DISCONNECT COUPLERS
BALL VALVES
LIVE SWIVEL
ASSEMBLY FABRICATION
ACCESSORIES
EQUIPMENT AND PARTS
KITS
AIR BRAKE HOSE ASSY
BRASS



## Foreign Thread Types – Japanese

There are two popular types of coupling styles in Japan, Japanese Industrial Standard and Komatsu. These couplings look similar to Male JIC and Female JIC Swivel couplings. However there are two major differences: The threads are BSP and the seat angle is only 30° instead of 37° for JIC.

- 1. Japanese Industrial Standard.** Most Japanese equipment uses this type of coupling with a 30° seat and British Standard Pipe Parallel threads. They are not interchangeable with British couplings, since the flare is not inverted.
- 2. Komatsu.** All Komatsu equipment uses couplings with a 30° seat and metric fine threads. All flanges are Code 61 or Code 62, except -10 which utilizes a special Komatsu-style flange that does not conform to SAE standard sizing.

### Japanese 30° Flare Parallel Threads

The Japanese 30° flare male connector will mate with a Japanese 30° flare female only.

The male and female have straight threads and a 30° seat. The seal is made on the 30° seat.

The threads on the Japanese 30° flare connector conform to JIS B 0202, which are the same as the BSPOR threads. Both the British and Japanese connectors have a 30° seat, but they are not interchangeable because the British seat is inverted.

Dash Size	Nominal Size (in)	Thread Size	Female Thread I.D. (in)	Male Thread O.D. (in)
-2	1/8	1/8 – 28	11/32	3/8
-4	1/4	1/4 – 19	7/16	17/32
-6	3/8	3/8 – 19	19/32	21/32
-8	1/2	1/2 – 14	3/4	13/16
-10	5/8	5/8 – 14	13/16	29/32
-12	3/4	3/4 – 14	15/16	1-1/32
-16	1	1 – 11	1-13/16	1-15/16
-20	1-1/4	1-1/4 – 11	1-17/32	1-21/32
-24	1-1/2	1-1/2 – 11	1-25/32	1-7/8
-32	2	2 – 11	2-7/32	2-11/32

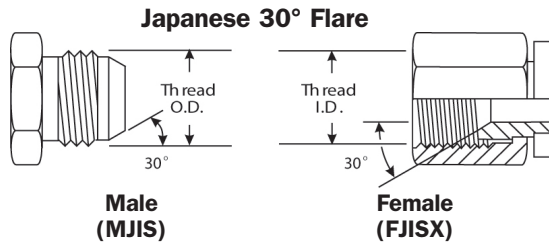

### Japanese Tapered Pipe Thread

The Japanese tapered pipe thread connector is identical to and fully interchangeable with the BSPT (tapered) connector. The Japanese connector does not have a 30° flare and will not mate with the BSPOR female.

The threads conform to JIS B 0203, which are the same as BSPT threads.

The seal on the Japanese tapered pipe thread connector is made on the threads.

Dash Size	Nominal Size (in)	Thread Size	Female Tapered Thread I.D. (in)	Male Tapered Thread O.D. (in)
-2	1/8	1/8 – 28	11/32	3/8
-4	1/4	1/4 – 19	7/16	17/32
-6	3/8	3/8 – 19	19/32	21/32
-8	1/2	1/2 – 14	3/4	13/16
-12	3/4	3/4 – 14	15/16	1-1/32
-16	1	1 – 11	1-13/16	1-15/16
-20	1-1/4	1-1/4 – 11	1-17/32	1-21/32
-24	1-1/2	1-1/2 – 11	1-25/32	1-7/8
-32	2	2 – 11	2-7/32	2-11/32
-32	2	2 – 11	2-7/32	2-11/32

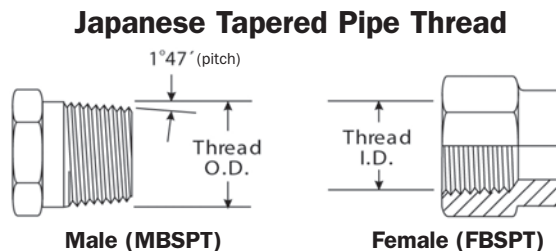

EQUIPMENT
HOSE/CPLG. SELECTION
G8K COUPLINGS
GLOBAL SPIRAL COUPLINGS
STAINLESS STEEL SPIRAL
MEGACRIMP COUPLINGS
STAINLESS STEEL BRAID
POWER CRIMP COUPLINGS
FIELD ATTACHABLE G1 & G2 COUPLINGS
FIELD ATTACHABLE C5 COUPLINGS
C14 COUPLINGS
GL COUPLINGS
GLX COUPLINGS
PCTS THERMOPLASTIC COUPLINGS
POLARSEAL COUPLINGS (ACA)
POLARSEAL II COUPLINGS (ACC)
POLARSEAL II COUPLINGS (ACB)
POWER STEERING ADAPTERS
QUICK DISCONNECT COUPLERS
BALL VALVES
LIVE SWIVEL
ASSEMBLY FABRICATION
ACCESSORIES
EQUIPMENT AND PARTS
KITS
AIR BRAKE HOSE ASSY
BRASS



## Foreign Thread Types – Japanese – Continued

### Komatsu Style 30° Flare Parallel Threads

The Komatsu style 30° flare parallel thread connector is identical to the Japanese 30° flare parallel thread connector except for the threads. The Komatsu style connector uses metric fine threads which conform to JIS B 0207. Gates identifies these as Komatsu-style by marking the hex nuts with two small notches.

The Komatsu style connector seals on the 30° flare.

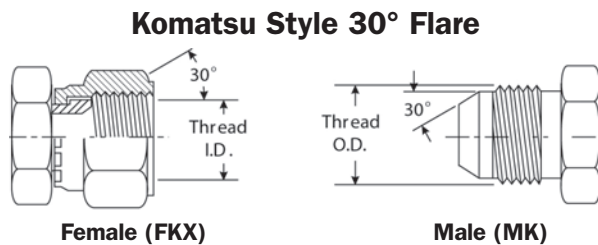

Dash Size	Nominal Size		Thread Size	Female Thread I.D. (mm)	Male Thread (O.D.) (mm)
	(in)	(mm)			
-4	1/4	6.4	M14x1.5	12.5	14
-6	3/8	9.5	M18x1.5	16.5	18
-8	1/2	12.7	M22x1.5	20.5	22
-10	5/8	15.9	M24x1.5	22.5	24
-12	3/4	19.1	M30x1.5	28.5	30
-16	1	25.4	M33x1.5	31.5	33
-20	1-1/4	31.8	M36x1.5	34.5	36
-24	1-1/2	38.1	M42x1.5	40.5	42

### Komatsu Style Flange Fitting

The Komatsu style flange fitting is nearly identical to and fully interchangeable with the SAE Code 61 flange fitting. In all sizes the o-ring dimensions are different. When replacing a Komatsu style flange with an SAE style flange, an SAE style o-ring must always be used.

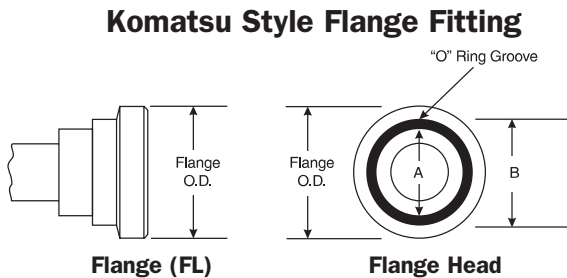

Dash Size	Nominal Size		Flange O.D. (in)	A (in)	B (in)
	(in)	(mm)			
-8	1/2	12.7	1.188	.728	.984
-10*	5/8	15.9	1.345	.728	1.102
-12	3/4	19.1	1.500	.846	1.220
-16	1	25.4	1.750	1.122	1.496
-20	1-1/4	31.8	2.000	1.358	1.732
-24	1-1/2	38.1	2.375	1.750	2.125
-32	2	50.8	2.812	2.225	2.559

\*(-10 is a non-SAE size flange)

### Metric Kobelco

These are similar to the German DIN 24° cone, but the DIN style uses coarser threads. Therefore, the Kobelco and German DIN are not interchangeable for female Kobelco (see French GAZ 24° swivel).

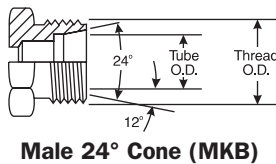

Dash Size	Metric Thread Size	Female Thread I.D. (mm)	Male Thread O.D. (mm)
-22	M30X1.5	28	30
-28	M36X1.5	34	36
-35	M45X1.5	43	45

EQUIPMENT
HOSE/CPLG. SELECTION
G8K COUPLINGS
GLOBALSPIRAL COUPLINGS
STAINLESS STEEL SPIRAL
MEGACRIMP COUPLINGS
STAINLESS STEEL BRAID
POWER CRIMP COUPLINGS
FIELD ATTACHABLE G1 & G2 COUPLINGS
FIELD ATTACHABLE C5 COUPLINGS
C14 COUPLINGS
GL COUPLINGS
GLX COUPLINGS
PCTS THERMOPLASTIC COUPLINGS
POLARSEAL COUPLINGS (ACA)
POLARSEAL II COUPLINGS (ACC)
POLARSEAL II COUPLINGS (ACB)
POWER STEERING
ADAPTERS
QUICK DISCONNECT COUPLERS
BALL VALVES
LIVE SWIVEL
ASSEMBLY FABRICATION
ACCESSORIES
EQUIPMENT AND PARTS
KITS
AIR BRAKE HOSE ASSY
BRASS



# GATES GLOBAL PART NUMBERING SYSTEM



EQUIPMENT
HOSE/CPLG. SELECTION
G8K COUPLINGS
GLOBALSPIRAL COUPLINGS
STAINLESS STEEL SPIRAL
MEGACRIMP COUPLINGS
STAINLESS STEEL BRAID
POWER CRIMP COUPLINGS
FIELD ATTACHABLE G1 & G2 COUPLINGS
FIELD ATTACHABLE C5 COUPLINGS
C14 COUPLINGS
GL COUPLINGS
GLX COUPLINGS
PCTS THERMOPLASTIC COUPLINGS
POLARSEAL COUPLINGS (ACA)
POLARSEAL II COUPLINGS (ACC)
POLARSEAL II COUPLINGS (ACB)
POWER STEERING
ADAPTERS
QUICK DISCONNECT COUPLERS
BALL VALVES
LIVE SWIVEL
ASSEMBLY FABRICATION
ACCESSORIES
EQUIPMENT AND PARTS
KITS
AIR BRAKE HOSE ASSY
BRASS

Gates couplings feature a meaningful part number that makes coupling identification fast and easy. Always refer to Gates Crimp Data Manual when selecting hose and coupling combinations.

In the following example, the Global Part Number G25100-0808 identifies a MegaCrimp® Male Pipe (MP) coupling with -8 (1/2") stem size and -8 (1/2") thread size.

# G25100-0808

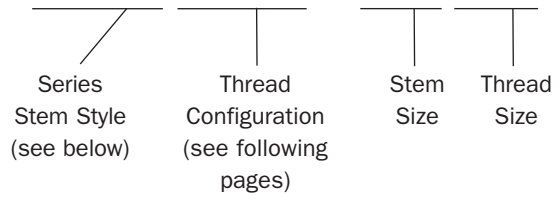

## Series Stem Styles:

- G17-** Stainless Steel Braid Couplings
- G18-** Stainless Steel Spiral Couplings
- G19-** G8K Couplings
- G20-** GlobalSpiral™ Couplings
- G21-** GlobalSpiral™ One Piece Couplings For MC4-20 Crimper
- G22-** GlobalSpiral™ Plus (GSP)
- G23-** GlobalSpiral™ Max (GSM) Pressure Couplings (-32)
- G24-** GlobalSpiral™ Max (GSM) Pressure Couplings (-24)
- G25-** MegaCrimp® Couplings
- G27-** Field Attachable Type T for G1 Hose (1 Wire)
- G28-** Field Attachable Type T for G2 Hose (2 Wire)
- G33-** Air Brake Couplings For Rubber Hose
- G34-** Field Attachable for C5CXH, C5C, C5D & C5M Hose
- G35-** Field Attachable for C5E Hose
- G36-** Brass Lock-On Field Attachable Couplings for LOC & LOL Hose
- G37-** Single Bead
- G38-** Barbed Stem
- G40-** C14 Couplings
- G43-** GL Couplings
- G44-** GLX® Couplings
- G45-** PolarSeal® Couplings (ACA)
- G46-** PolarSeal® II Couplings (ACC)
- G47-** PolarSeal® II Couplings (ACB)
- G50-** Power Steering Couplings
- G51-** PCTS Thermoplastic Couplings

## Other Non-Stem Series Styles:

- G52-** Gates OE-Style Clamp Collars
- G60-** SAE to SAE Adapters
- G62-** British to SAE Adapters
- G63-** Metric Conversion Adapters
- G64-** International to International Adapters
- G65-** Japanese Conversion Adapters
- G73-** Ermeto Adapters
- G80-** Hose Bend Restrictors
- G81-** Hose Guards
- G82-** Plated Flat Armor Spring Guards
- G83-** Plated Wire Spring Guards
- G89-** C14 Assembly
- G93-** Live Swivel
- G94-** Quick Disconnect Couplers
- G95-** Quick Disconnect Couplers
- G96-** Ball Valves



# Thread Configurations for Stem Styles

These three-digit numbers identify the various coupling thread configurations

<b>100-</b> MP	Male Pipe (NPTF - 30° Cone Seat)	<b>311-</b> FL67	Code 61 O-Ring Flange - 67 1/2° Bent Tube
<b>101-</b> MPLN	Male Pipe Long Nose	<b>313-</b> FL90XS	Code 61 O-Ring Flange - 90° Bent Tube - Extra Short
<b>102-</b> MPAPI	API Line Pipe Connection	<b>314-</b> FL90S	Code 61 O-Ring Flange - 90° Bent Tube - Short
<b>103-</b> MPLH	Male Pipe (NPTF - 30° Cone Seat) - Long Hex	<b>315-</b> FL90M	Code 61 O-Ring Flange - 90° Bent Tube - Medium
<b>105-</b> MPX	Male Pipe Swivel (NPTF - Without 30° Cone Seat)	<b>316-</b> FL90L	Code 61 O-Ring Flange - 90° Bent Tube - Long
<b>106-</b> MPX90	Male Pipe Swivel - 90° Block (NPTF - Without 30° Cone Seat)	<b>317-</b> FL90XL	Code 61 O-Ring Flange - 90° Bent Tube - Extra Long
		<b>318-</b> FL90XXL	Code 61 O-Ring Flange - 90° Bent Tube - Extra Extra Long
<b>107-</b> MPX90L	Male Pipe Swivel - 90° Long Block (NPTF - Without 30° Cone Seat)	<b>319-</b> FL90	Code 61 O-Ring Flange - 90° Bent Tube (Non-ISO)
		<b>323-</b> FL100	Code 61 O-Ring Flange - 100° Bent Tube
<b>110-</b> FP	Female Pipe (NPTF - Without 30° Cone Seat)	<b>325-</b> FL110	Code 61 O-Ring Flange - 110° Bent Tube
<b>111-</b> FPX	Female Pipe Swivel (NPSM - 30° Cone Seat)	<b>327-</b> FL120	Code 61 O-Ring Flange - 120° Bent Tube
<b>120-</b> MB	Male O-Ring Boss	<b>329-</b> FL125	Code 61 O-Ring Flange - 125° Bent Tube
<b>121-</b> MBX	Male O-Ring Boss Swivel	<b>331-</b> FL135	Code 61 O-Ring Flange - 135° Bent Tube
<b>122-</b> MBX45BL	Male O-Ring Boss Swivel - 45° Block	<b>333-</b> FLCF	Code 61 Captive O-Ring Flange
<b>123-</b> MBX90BL	Male O-Ring Boss Swivel - 90° Block	<b>334-</b> FLCF45	Code 61 Captive O-Ring Flange - 45° Bent Tube
<b>124-</b> MBX90BL	Male O-Ring Boss Swivel - 90° Block Long	<b>335-</b> FLCF90	Code 61 Captive O-Ring Flange - 90° Bent Tube
<b>126-</b> MBX45	Male O-Ring Boss Swivel - 45° Bent Tube	<b>342-</b> RFL90S	Special Flange - 90°
<b>128-</b> MBX90	Male O-Ring Boss Swivel - 90° Bent Tube	<b>350-</b> FLH	Code 62 O-Ring Flange Heavy
<b>134-</b> MBAX90M	Male O-Ring Boss Adapterless Swivel - 90° Bent Tube - Medium	<b>352-</b> FLH22	Code 62 O-Ring Flange Heavy - 22 1/2° Bent Tube
		<b>353-</b> FLH20	Code 62 O-Ring Flange Heavy - 22° Bent Tube
<b>140-</b> FMX	Female MegaSeal Swivel	<b>354-</b> FLH30	Code 62 O-Ring Flange Heavy - 30° Bent Tube
<b>145-</b> FMX45	Female MegaSeal Swivel - 45° Bent Tube	<b>355-</b> FLH30	Code 62 O-Ring Flange Heavy - 30° Bent Tube (Non-Std.)
<b>149-</b> FMX90S	Female MegaSeal Swivel - 90° Bent Tube - Short	<b>357-</b> FLH45	Code 62 O-Ring Flange Heavy - 45° Bent Tube
<b>150-</b> FMX90	Female MegaSeal Swivel - 90° Bent Tube	<b>359-</b> FLH60	Code 62 O-Ring Flange Heavy - 60° Bent Tube
<b>151-</b> FMX90L	Female MegaSeal Swivel - 90° Bent Tube - Long	<b>360-</b> FLH67	Code 62 O-Ring Flange Heavy - 67 1/2° Bent Tube
<b>165-</b> MJ	Male JIC 37° Flare	<b>364-</b> FLH90S	Code 62 O-Ring Flange Heavy - 90° Bent Tube - Short
<b>170-</b> FJX	Female JIC 37° Flare Swivel	<b>365-</b> FLH90M	Code 62 O-Ring Flange Heavy - 90° Bent Tube - Medium
<b>171-</b> FJXL	Female JIC 37° Flare Swivel - Long	<b>366-</b> FLH90L	Code 62 O-Ring Flange Heavy - 90° Bent Tube - Long
<b>172-</b> FJX30	Female JIC 37° Flare Swivel - 30° Bent Tube	<b>367-</b> FLH90XL	Code 62 O-Ring Flange Heavy - 90° Bent Tube - Extra Long (Non-ISO)
<b>174-</b> FJX45S	Female JIC 37° Flare Swivel - 45° Bent Tube - Short		
<b>175-</b> FJX45	Female JIC 37° Flare Swivel - 45° Bent Tube	<b>369-</b> FLH110	Code 62 O-Ring Flange Heavy -110° Bent Tube
<b>176-</b> FJX45L	Female JIC 37° Flare Swivel - 45° Bent Tube - Long	<b>370-</b> FLFF	Code 61 Flange Without O-Ring Groove
<b>177-</b> FJX60	Female JIC 37° Flare Swivel - 60° Bent Tube	<b>374-</b> FLHCF	Code 62 O-Ring Flange Heavy with Captive Flange
<b>179-</b> FJX90S	Female JIC 37° Flare Swivel - 90° Bent Tube - Short	<b>376-</b> FLHCF45	Code 62 O-Ring Flange Heavy with Captive Flange - 45° Bent Tube
<b>180-</b> FJX90M	Female JIC 37° Flare Swivel - 90° Bent Tube - Medium		
<b>181-</b> FJX90L	Female JIC 37° Flare Swivel - 90° Bent Tube - Long	<b>380-</b> FLHCF90	Code 62 O-Ring Flange Heavy with Captive Flange - 90° Bent Tube
<b>182-</b> FJX90XL	Female JIC 37° Flare Swivel - 90° Bent Tube - Extra Long		
<b>183-</b> FJX90	Female JIC 37° Flare Swivel - 90° Bent Tube	<b>386-</b> FLHCFM	Code 62 O-Ring Flange Heavy Captive Flange Metric Bolts
<b>187-</b> FJX90BLK	Female JIC 37° Flare Swivel - 90° Block		
<b>195-</b> MS	Male SAE 45° Flare	<b>400-</b> FLC	Caterpillar Style O-Ring Flange
<b>196-</b> MS45	Male SAE 45° Flare - 45° Bent Tube	<b>401-</b> FLCCL	Caterpillar Style O-Ring Flange - Long
<b>197-</b> MS90	Male SAE 45° Flare - 90° Bent Tube	<b>402-</b> FLC22	Caterpillar Style O-Ring Flange - 22 1/2° Bent Tube
<b>200-</b> FSX	Female SAE 45° Flare Swivel	<b>404-</b> FLC30	Caterpillar Style O-Ring Flange - 30° Bent Tube
<b>202-</b> FSX45	Female SAE 45° Flare Swivel - 45° Bent Tube	<b>407-</b> FLC45	Caterpillar Style O-Ring Flange - 45° Bent Tube
<b>204-</b> FSX90S	Female SAE 45° Flare Swivel - 90° Bent Tube - Short	<b>408-</b> FLC45	Caterpillar Style O-Ring Flange - 45° Bent Tube
<b>205-</b> FSX90	Female SAE 45° Flare Swivel - 90° Bent Tube	<b>409-</b> FLC60	Caterpillar Style O-Ring Flange - 60° Bent Tube
<b>206-</b> FSX90L	Female SAE 45° Flare Swivel - 90° Bent Tube - Long	<b>410-</b> FLC67	Caterpillar Style O-Ring Flange - 67 1/2° Bent Tube
<b>210-</b> FJSX	Dual Seat Female JIC 37°/SAE 45° Flare Swivel	<b>415-</b> FLC90	Caterpillar Style O-Ring Flange - 90° Bent Tube
<b>211-</b> FJSX45	Dual Seat Female JIC 37°/SAE 45° Flare Swivel - 45° Bent Tube	<b>416-</b> FLC90L	Caterpillar Style O-Ring Flange - 90° Bent Tube - Long
		<b>420-</b> FPFL	Female French GAZ (Poclairn) 24° High Pressure Flange
<b>212-</b> FJSX90	Dual Seat Female JIC 37°/SAE 45° Flare Swivel - 90° Bent Tube		
<b>213-</b> FJSX90L	Dual Seat Female JIC 37°/SAE 45° Flare Swivel - 90° Bent Tube - Long	<b>460-</b> ABC	Air Brake Compression
		<b>461-</b> STA	Straight Tube Assembly
<b>225-</b> MFFOR	Male Flat-Face O-Ring	<b>462-</b> STA-ABC	Straight Tube Assembly (STA) and One Air Brake Compression (ABC)
<b>226-</b> MFFORBKHDLN	Male Flat-Face O-Ring Bulk Head Long Nose		
<b>228-</b> MFFORBKHHD	Male Flat-Face O-Ring Bulk Head	<b>480-</b> MPFL	Male French GAZ (Poclairn) 24° High Pressure Flange
<b>230-</b> FFORX	Female Flat-Face O-Ring Swivel	<b>482-</b> MPFL90	Male French GAZ (Poclairn) 24° High Pressure Flange - 90° Bent Tube
<b>232-</b> FFORX22	Female Flat-Face O-Ring Swivel - 22 1/2° Bent Tube		
<b>233-</b> FFORX30	Female Flat-Face O-Ring Swivel - 30° Bent Tube	<b>500-</b> MIX	SAE Male Inverted Swivel
<b>234-</b> FFORX45S	Female Flat-Face O-Ring Swivel - 45° Bent Tube - Short	<b>502-</b> MIX45	SAE Male Inverted Swivel - 45° Bent Tube
<b>235-</b> FFORX45	Female Flat-Face O-Ring Swivel - 45° Bent Tube	<b>504-</b> MIX90	SAE Male Inverted Swivel - 90° Bent Tube
<b>238-</b> FFORX67	Female Flat-Face O-Ring Swivel - 67 1/2° Bent Tube	<b>510-</b> MFA	SAE Male Flareless Assembly
<b>239-</b> FFORX90S	Female Flat-Face O-Ring Swivel - 90° Bent Tube - Short	<b>511-</b> MFA90	Male SAE Flareless Assembly - 90° Block
<b>240-</b> FFORX90M	Female Flat-Face O-Ring Swivel - 90° Bent Tube - Medium	<b>520-</b> NASP	North American Stand Pipe
<b>241-</b> FFORX90L	Female Flat-Face O-Ring Swivel - 90° Bent Tube - Long	<b>527-</b> FBO	Female Braze-On Stems
<b>248-</b> FFORX135	Female Flat-Face O-Ring Swivel - 135° Bent Tube	<b>534-</b> HLEC	Hose Length Extender - Caterpillar
<b>300-</b> FL	Code 61 O-Ring Flange	<b>535-</b> HLE	Hose Length Extender
<b>301-</b> FLL	Code 61 O-Ring Flange Long Neck	<b>536-</b> HLE45	Hose Length Extender - 45° Bent Tube
<b>302-</b> FL22M	Code 61 O-Ring Flange - 22 1/2° Bent Tube - Medium	<b>537-</b> HLE90	Hose Length Extender - 90° Bent Tube
<b>304-</b> FL30	Code 61 O-Ring Flange - 30° Bent Tube	<b>538-</b> HLESG	Hose Length Extender with Sight Glass
<b>306-</b> FL45S	Code 61 O-Ring Flange - 45° Bent Tube - Short	<b>539-</b> HLET	Hose Length Extender - Tee
<b>307-</b> FL45	Code 61 O-Ring Flange - 45° Bent Tube	<b>540-</b> FABX	Female Air Brake Swivel
<b>308-</b> FL60S	Code 61 O-Ring Flange - 60° Bent Tube - Short	<b>541-</b> HLE180	Hose Length Extender - 180° Bent Tube
<b>309-</b> FL60M	Code 61 O-Ring Flange - 60° Bent Tube - Medium	<b>542-</b> HLEY	Y Splicer
		<b>543-</b> TBLFX	Two-Bolt Flange Swivel

EQUIPMENT
HOSE/CPLG. SELECTION
G8K COUPLINGS
GLOBALSPIRAL COUPLINGS
STAINLESS STEEL SPIRAL
MEGACRIMP COUPLINGS
STAINLESS STEEL BRAID
POWER CRIMP COUPLINGS
FIELD ATTACHABLE G1 & G2 COUPLINGS
FIELD ATTACHABLE C5 COUPLINGS
C14 COUPLINGS
GL COUPLINGS
GLX COUPLINGS
PCTS THERMOPLASTIC COUPLINGS
POLARSEAL COUPLINGS (ACA)
POLARSEAL II COUPLINGS (ACC)
POLARSEAL II COUPLINGS (ACB)
POWER STEERING
ADAPTERS
QUICK DISCONNECT COUPLERS
BALL VALVES
LIVE SWIVEL
ASSEMBLY FABRICATION
ACCESSORIES
EQUIPMENT AND PARTS
KITS
AIR BRAKE HOSE ASSY
BRASS



## Thread Configurations for Stem Styles – Continued

EQUIPMENT
HOSE/CPLG. SELECTION
G8K COUPLINGS
GLOBAL SPIRAL COUPLINGS
STAINLESS STEEL SPIRAL
MEGACRIMP COUPLINGS
STAINLESS STEEL BRAID
POWER CRIMP COUPLINGS
FIELD ATTACHABLE G1 & G2 COUPLINGS
FIELD ATTACHABLE C5 COUPLINGS
C14 COUPLINGS
GL COUPLINGS
GLX COUPLINGS
PCTS THERMOPLASTIC COUPLINGS
POLARSEAL COUPLINGS (ACA)
POLARSEAL II COUPLINGS (ACC)
POLARSEAL II COUPLINGS (ACB)
POWER STEERING
ADAPTERS
QUICK DISCONNECT COUPLERS
BALL VALVES
LIVE SWIVEL
ASSEMBLY FABRICATION
ACCESSORIES
EQUIPMENT AND PARTS
KITS
AIR BRAKE HOSE ASSY
BRASS

<b>561-</b> FG	Female Grease	<b>830-</b> FBSPX	Female British Standard Parallel Pipe O-Ring Swivel
<b>562-</b> FZX	Female Parker Triple Thread Flare	<b>830-</b> FBSPORX	Female British Standard Parallel Pipe O-Ring Swivel
<b>563-</b> PWX	Pressure Wash Swivel	<b>831-</b> FBSPORX45	Female British Standard Parallel Pipe O-Ring Swivel - 45° Bent Tube
<b>564-</b> BJ	US Banjo	<b>832-</b> FBSPORX90	Female British Standard Parallel Pipe O-Ring Swivel - 90° Bent Tube
<b>570-</b> VIC	Victaulic Nipple	<b>845-</b> FBSPORX90BL	Female British Standard Parallel Pipe O-Ring Swivel - 90° Block
<b>576-</b> FTON134SP45	Female O-Ring with R134 Service Port - 45° Bent Tube	<b>850-</b> BSPBJ	International Thread British Std Pipe Banjo
<b>577-</b> FTON12SP45	Female O-Ring with R12 Service Port - 45° Bent Tube	<b>855-</b> FBFFX	Female British Flat-Face Swivel
<b>578-</b> MTON180	Male O-Ring - 180° Bent Tube	<b>857-</b> FLSHCF	ISO 6164 4-Bolt Heavy Captive Flange
<b>580-</b> MTON134SP	Male SAE Tube O-Ring Nut Swivel with R134a Service Port	<b>860-</b> XXSBW	GSM Butt Weld
<b>582-</b> MTON134SP90	Male SAE Tube O-Ring Nut Swivel with R134a Service Port - 90° Bent Tube	<b>910-</b> FXK	Female Komatsu Style Japanese Metric Swivel
<b>583-</b> MTON	Male SAE Tube O-Ring Nut Swivel	<b>911-</b> FXK45	Female Komatsu Style Japanese Metric Swivel - 45° Bent Tube
<b>584-</b> MTON45	Male SAE Tube O-Ring Nut - 45° Bent Tube	<b>913-</b> FXK90	Female Komatsu Style Japanese Metric Swivel - 90° Bent Tube
<b>585-</b> MTON90	Male SAE Tube O-Ring Nut - 90° Bent Tube	<b>930-</b> FJISX	Female Japanese Industrial Standard Swivel
<b>586-</b> FTONR12SP	Female SAE Tube O-Ring Nut Swivel with R12 Service Port	<b>932-</b> FJISPX	Female Japanese Inverted Flare Parallel Threads
<b>587-</b> FTONR12SP90	Female SAE Tube O-Ring Nut Swivel with R12 Service - 90° Bent Tube	<b>934-</b> FJISX90S	Female Japanese Industrial Standard Swivel - 90° Bent Tube
<b>588-</b> FTON134SP	Female SAE Tube O-Ring Nut Swivel with R134a Service Port	<b>935-</b> MMFA	Male Metric Flareless Assembly
<b>589-</b> FTON134SP90	Female SAE Tube O-Ring Nut Swivel with R134a Service Port - 90° Bent Tube	<b>947-</b> FSLTORSP	Female (Ford) Spring Lock Tee O-Ring Splicer
<b>590-</b> FTON	Female SAE Tube O-Ring Nut Swivel	<b>948-</b> FSLSP	Female (Ford) Spring Lock Liquid Line Splicer
<b>591-</b> FTON45	Female SAE Tube O-Ring Nut Swivel - 45° Bent Tube	<b>949-</b> MSL45	Male (Ford) Spring Lock - 45° Bent Tube
<b>592-</b> FTON90	Female SAE Tube O-Ring Nut Swivel - 90° Bent Tube	<b>950-</b> MSL	Male (Ford) Spring Lock
<b>593-</b> FTOMN	Female SAE Tube O-Ring Metric Nut Swivel	<b>951-</b> MSL90	Male (Ford) Spring Lock - 90° Bent Tube
<b>594-</b> FTOMN45	Female SAE Tube O-Ring Metric Nut Swivel - 45° Bent Tube	<b>952-</b> FSL	Female (Ford) Spring Lock
<b>595-</b> FTOMN90	Female SAE Tube O-Ring Metric Nut Swivel - 90° Bent Tube	<b>953-</b> FSL90	Female (Ford) Spring Lock - 90° Bent Tube
<b>596-</b> FTON90BL	Female SAE Tube O-Ring Nut Swivel - 90° Block	<b>954-</b> R12SP	Hose Splicer with R12 Thread Service Port
<b>597-</b> MIO	Male Inverted O-Ring	<b>955-</b> FSL45	Female (Ford) Spring Lock - 45° Bent Tube
<b>598-</b> MIO45	Male Inverted O-Ring - 45° Bent Tube	<b>956-</b> R134SP	Hose Splicer with R134a Service Port
<b>599-</b> MIO90	Male Inverted O-Ring - 90° Bent Tube	<b>957-</b> R134SP-RL	Female Rotalok with R134a Service Port - 90° Block
<b>600-</b> MIOBKHD	Male Inverted O-Ring Bulkhead	<b>958-</b> CFTON90	Compressor Female SAE Tube O-Ring Nut Swivel - 90° Bent Tube
<b>602-</b> MIOBKHD90	Male Inverted O-Ring Bulkhead - 90° Bent Tube	<b>959-</b> CFTON90BL	Compressor Female SAE Tube O-Ring Nut Swivel - 90° Block
<b>604-</b> FTDON	Female SAE Tube Dual O-Ring Nut	<b>960-</b> CFTON134SP90BL	Compressor Female Tube O-Ring Nut with 134a Service Port - 90° Block
<b>605-</b> FTDON45	Female SAE Tube Dual O-Ring Nut - 45° Bent Tube	<b>961-</b> CBSR12SP90	Compressor Block - Single w/Switch or Service Port - 90° Bent Tube
<b>606-</b> FTDON90	Female SAE Tube Dual O-Ring Nut - 90° Bent Tube	<b>962-</b> CBSRR12SP90	Compressor Block - Single Reverse w/Switch or Service Port - 90° Bent Tube
<b>607-</b> FTDOMN	Female SAE Tube Dual O-Ring Metric Nut	<b>963-</b> FTOMN90134SPH	Metric Female O-Ring (FOR) with Switch or Service Port - 90° Bent Tube
<b>608-</b> FTDOMN45	Female SAE Tube Dual O-Ring Metric Nut - 45° Bent Tube	<b>964-</b> FTOMN90SPL	Metric Female O-Ring (FOR) with Switch or Service Port - 90° Bent Tube
<b>609-</b> FTDOMN90	Female SAE Tube Dual O-Ring Metric Nut - 90° Bent Tube	<b>965-</b> MIOM	Metric Male Insert O-Ring (MIO)
<b>610-</b> FTON180	Female SAE Tube O-Ring Nut - 180° Bent Tube	<b>970-</b> MQLH	Male Quick-Lok® High
<b>611-</b> MIO134SP	Male Inverted O-Ring with R134a Service Port	<b>971-</b> MQLH45S	Male Quick-Lok® High - 45° Bent Tube - Short
<b>613-</b> MIO134SP90	Male Inverted O-Ring with R134a Service Port - 90° Bent Tube	<b>972-</b> MQLH90S	Male Quick-Lok® High - 90° Bent Tube - Short
<b>614-</b> TORSP	Universal Tee O-Ring Splicer English Threads	<b>973-</b> MQLH90L	Male Quick-Lok® High - 90° Bent Tube - Long
<b>615-</b> MDL	Male DIN 24° Cone - Light Series	<b>974-</b> FQLH-MB	Female Quick-Lok® High to Male O-Ring Boss Adapter
<b>645-</b> FDLORX	Female DIN 24° Cone Swivel - Light Series with O-Ring	<b>976-</b> FQLH-FJ	Female Quick-Lok® High to Female JIC 37 Flare
<b>650-</b> FDLORX45	Female DIN 24° Cone Swivel - Light Series with O-Ring - 45° Bent Tube	<b>978-</b> FQLH-FFORX	Female Quick-Lok® High to Female Flat-Face
<b>655-</b> FDLORX90	Female DIN 24° Cone Swivel - Light Series with O-Ring - 90° Bent Tube	<b>980-</b> MQLL	Male Quick-Lok® Low
<b>675-</b> MFG	Male French GAZ	<b>981-</b> MQLL45	Male Quick-Lok® Low - 45° Bent Tube
<b>680-</b> FFGX	Female French GAZ Swivel (Female Kobelco)	<b>982-</b> MQLL90	Male Quick-Lok® Low - 90° Bent Tube
<b>688-</b> FTON134SPH	Female SAE Tube O-Ring Nut Swivel with R134a High Pressure Service Port	<b>983-</b> MQLL90M	Male Quick-Lok® Low - 90° Bent Tube - Medium
<b>690-</b> FFGX90	Female French GAZ Swivel - 90° Bent Tube (Female Kobelco)	<b>984-</b> MQLL90L	Male Quick-Lok® Low - 90° Bent Tube - Long
<b>691-</b> FFGX90S	Female French GAZ Swivel - 90° Bent Tube - Short (Female Kobelco)	<b>995-</b> B1F	Non-Skive Ferrule - Stainless Steel Braid
<b>715-</b> MDH	Male DIN 24° Cone - Heavy Series	<b>995-</b> CLAMP	Clamp Assemblies
<b>720-</b> FDHORX	Female DIN 24° Cone Swivel - Heavy Series with O-Ring	<b>995-</b> G8K1F	G8K Ferrule for G8K Spiral Hose
<b>725-</b> FDHORX45	Female DIN 24° Cone Swivel - Heavy Series with O-Ring - 45° Bent Tube	<b>995-</b> GS1F	GS Ferrule for Wire Braid Hose
<b>730-</b> FDHORX90	Female DIN 24° Cone Swivel - Heavy Series with O-Ring - 90° Bent Tube	<b>995-</b> GS1F-4	GS Ferrule for 4-Spiral Hose
<b>735-</b> MKB	Male Kobelco (Male French GAZ)	<b>995-</b> GS1F-6	GS Ferrule for 6-Spiral Hose
<b>750-</b> MSP	Metric Light Stand Pipe	<b>995-</b> GSP1F-2	GSP Ferrule for Wire Braid Hose
<b>770-</b> DBJ	International Thread Metric 7642 DIN Banjo	<b>995-</b> GSP1F-4	GSP Ferrule for 4-Spiral Hose
<b>795-</b> MBSPT	Male British Standard Pipe Tapered/Japanese Tapered Thread	<b>995-</b> S1F	Non-Skive Ferrules - Stainless Steel Spiral
<b>810-</b> MBSPP	Male British Standard Pipe Parallel	<b>995-</b> S2F	Skive Ferrules - Stainless Steel Spiral
		<b>997-</b> GSID1F	GS Ferrule for ID5K Hose



# Air Brake

In the following example, the Global Part Number G33100-0808 identifies a Air Brake Male Pipe (MP) coupling with -8 (1/2") tube size and -8 (1/2") thread size.

**G 33**



**Series Stem Style**  
(see below)

**1 00 -**



**Thread Configuration**  
(see below)

**0 8**



**Stem Size**  
(1/2")

**0 8**

**Thread Size**  
(1/2")

## Series Stem Styles:

### Air Brake

**G33**—Air Brake Fittings for Rubber Hose

### Brass Stemed Fittings

**G36** -Brass Lock-On Field Attachable

**G37** -Single Bead

**G38** -Barb Stem

## THREAD CONFIGURATIONS

These three-digit numbers identify the various coupling thread configurations

### Air Brake – G33

<b>021</b> — MP-ATDV	Air Tank Drain Valve	<b>656</b> — FP-FPFWTV-L	Truck Valve - 4-Way
<b>022</b> — MP-AV	Air Vent	<b>701</b> — MFA-MFASC	Shut-Off Cock - Copper Tubing Ind. Compression to Copper Tubing Ind. Compression Run
<b>027</b> — MP-CV	One Way Check Valve	<b>705</b> — MFA-MPSC	Shut-Off Cock - Copper Tubing Industrial Compression to Male Pipe Run
<b>030</b> — MAB-MP	Male Air Brake to Male Pipe Adapter	<b>710</b> — MP-FPSC	Shut-Off Cock - Male Pipe to Female Pipe Run
<b>031</b> — GH	Gladhand	<b>715</b> — FP-FPSC	Shut-Off Cock - Female Pipe to Female Pipe Run
<b>032</b> — GH-SEAL	Gladhand Seal	<b>720</b> — MS-MPSC	Shut-Off Cock - Male SAE 45° Flare to Male Pipe Run
<b>050</b> — TS-ABR	Sleeve	<b>730</b> — MS-MSSC	Shut-Off Cock - Male SAE 45° Flare to Male SAE 45° Flare Run
<b>060</b> — TSN-ABR	Nut	<b>801</b> — MP-ADC	Air Shut-Off Cock - Male Pipe to Bibb Nose
<b>061</b> — SGN-ABR	Spring Guard Nut	<b>805</b> — FP-MPADC	Air Drain Cock - Male Pipe to Female Pipe
<b>100</b> — ABR-MP	Air Brake to Male Pipe with Nut and Sleeve	<b>823</b> — BN-MPDC90	Drain Cock 90° - Single Bead to Male Pipe - Long
<b>110</b> — ABRSG-MP	Air Brake to Male Pipe with Spring Guard	<b>830</b> — MP-ISDC	Drain Cock - Male Pipe Internal Seat - Bibb Nose - Long
<b>111</b> — ABRI-MP	Air Brake to Male Pipe without Nut and Sleeve	<b>831</b> — MP-ESDC	Drain Cock - Male Pipe to Tube External Seat - Long
<b>112</b> — SGABR	Air Brake Spring Guard	<b>832</b> — MP-ADCBN	Air Shut-off Cock - Male Pipe - Bibb Nose with Key Handle
<b>150</b> — ABR-FABX	Air Brake to Female Air Brake Swivel	<b>850</b> — ATNKV	Air Tank Valve
<b>151</b> — ABR-FABX-MPA	Air Brake to Female Air Brake Swivel with Adapter	<b>901</b> — MFA-MFANV	Needle Valve - Copper Tubing Ind. Compression to Copper Tubing Ind. Compression Run
<b>300</b> — FP-FPBKHD	Female Pipe to Female Pipe Bulkhead	<b>905</b> — MFA-MP90NV	Needle Valve 90° - Copper Tubing Industrial Compression to Male Pipe
<b>301</b> — FP-FPBKHDS	Female Pipe to Female Pipe Bulkhead	<b>910</b> — MFA-MPNV	Needle Valve - Copper Tubing Industrial Compression to Male Pipe
<b>302</b> — MP-FPBKHDL	Male Pipe to Female Pipe Bulkhead	<b>915</b> — MP-MPNV	Needle Valve - Male Pipe to Male Pipe
<b>303</b> — MP-FPBKHD	Male Pipe to Female Pipe Bulkhead	<b>920</b> — MP-FPNV	Needle Valve - Male Pipe to Female Pipe
<b>400</b> — ABR-ABR	Air Brake Union	<b>930</b> — FP-FPNV	Needle Valve - Female Pipe to Female Pipe
<b>610</b> — MP-MS90-TV	Truck Valve 90° - Male SAE 45° Flare to Male Pipe Run		
<b>612</b> — MS-MP90-TV	Truck Valve 90° - Male SAE 45° to Male Pipe Branch		
<b>620</b> — SB-MP90-TV	Truck Valve 90° - Single Bead to Male Pipe Run		
<b>622</b> — SB-MP90-TVP	Truck Valve 90° - Barbed to Male Pipe Branch with Pin Handle		
<b>630</b> — FP-MP90-TV	Truck Valve 90° - Male Pipe to Female Pipe Branch		
<b>650</b> — FP-FP-FPWTV	Truck Valve - 3-Way		
<b>655</b> — FP-FP-FPWTV	Truck Valve - 4-Way		

EQUIPMENT
HOSE/CPLG. SELECTION
G8K COUPLINGS
GLOBAL SPIRAL COUPLINGS
STAINLESS STEEL SPIRAL
MEGACRIMP COUPLINGS
STAINLESS STEEL BRAID
POWER CRIMP COUPLINGS
FIELD ATTACHABLE G1 & G2 COUPLINGS
FIELD ATTACHABLE C5 COUPLINGS
C14 COUPLINGS
GL COUPLINGS
GLX COUPLINGS
PCTS THERMOPLASTIC COUPLINGS
POLARSEAL COUPLINGS (ACA)
POLARSEAL II COUPLINGS (ACC)
POLARSEAL II COUPLINGS (ACB)
POWER STEERING
ADAPTERS
QUICK DISCONNECT COUPLERS
BALL VALVES
LIVE SWIVEL
ASSEMBLY FABRICATION
ACCESSORIES
EQUIPMENT AND PARTS
KITS
AIR BRAKE HOSE ASSY
BRASS



## Air Brake – Continued

EQUIPMENT
HOSE/CPLG. SELECTION
G8K COUPLINGS
GLOBAL SPIRAL COUPLINGS
STAINLESS STEEL SPIRAL
MEGACRIMP COUPLINGS
STAINLESS STEEL BRAID
POWER CRIMP COUPLINGS
FIELD ATTACHABLE G1 & G2 COUPLINGS
FIELD ATTACHABLE C5 COUPLINGS
C14 COUPLINGS
GL COUPLINGS
GLX COUPLINGS
PCTS THERMOPLASTIC COUPLINGS
POLARSEAL COUPLINGS (ACA)
POLARSEAL II COUPLINGS (ACC)
POLARSEAL II COUPLINGS (ACB)
POWER STEERING
ADAPTERS
QUICK DISCONNECT COUPLERS
BALL VALVES
LIVE SWIVEL
ASSEMBLY FABRICATION
ACCESSORIES
EQUIPMENT AND PARTS
KITS
AIR BRAKE HOSE ASSY
BRASS

### Air Brake – G33 — Continued

- 940** — MS-MPNV Needle Valve - Male SAE 45° Flare to Male Pipe
- 945** — MS-MP90NV Needle Valve 90° - Male SAE 45° Flare to Male Pipe
- 950** — MS-MSNV Needle Valve - Male SAE 45° Flare to Male SAE 45° Flare

### Brass Stemed Fittings – G36

- |  |   |
|--|---|
| <b>100</b> — LOC-RMP Male Pipe with Cone Seat                        | <b>500</b> — LOC-RMIX Male SAE Inverted Flare Swivel      |
| <b>105</b> — LOC-RMPX Male Pipe Swivel without Cone Seat             | <b>508</b> — LOC-RFI Female SAE Inverted Flare            |
| <b>106</b> — LOC-RMP90 Male Pipe 90° Block with Cone Seat            | <b>520</b> — LOC-RFT North American Stand Pipe            |
| <b>110</b> — LOC-RFP Female Pipe without Cone Seat                   | <b>520</b> — LOC-RSP North American Stand Pipe            |
| <b>111</b> — LOC-RFPX Female Pipe Swivel with Cone Seat              | <b>535</b> — LOC-RHM Hose Length Extenders                |
| <b>165</b> — LOC-RMJ Male JIC 37° Flare                              | <b>795</b> — LOC-MBSPT Male British Standard Pipe Tapered |
| <b>170</b> — LOC-RFJX Female JIC 37° Flare Swivel                    |   |
| <b>195</b> — LOC-RMS Male SAE 45° Flare                              |   |
| <b>200</b> — LOC-RFSX Female SAE 45° Flare Swivel                    |   |
| <b>210</b> — LOC-RFJSX Dual Seat Female JIC 37°/SAE 45° Flare Swivel |   |

### Brass Stemed Fittings – G37

- |   |   |
|---|---|
| <b>100</b> — SB-RMP Male Pipe with Cone Seat        | <b>500</b> — SB-RMIX Male SAE Inverted Flare Swivel         |
| <b>103</b> — SB-MSC Male Straight Thread Connector  | <b>503</b> — SB-RMIX45 Male SAE Inverted Flare Swivel - 45° |
| <b>106</b> — SB-RMP90 Male Pipe 90° Block Cone Seat | <b>504</b> — SB-RMIX90 Male SAE Inverted Flare Swivel - 90° |
| <b>195</b> — SB-RMS Male SAE 45° Flare Connector    | <b>508</b> — SB-RFI Female SAE Inverted Flare               |

### Brass Stemed Fittings – G38

- |  |                                     |
|--|-------------------------------------|
| <b>100</b> — BS-MP Male Pipe NPTF with Cone Seat | <b>110</b> — BS-FP Female Pipe NPTF |
|--|-------------------------------------|





# Adapters

In the following example, the Global Part Number G60110-0808 identifies a Male Pipe NPTF (MP) to Male Pipe NPTF (MP) adapter with -8 (1/2") pipe thread and -8 (1/2") pipe thread size. Meets SAE100R2 working pressures except where noted.

### SERIES STEM STYLES:

**G60** - SAE to SAE **G62** - British to SAE **G63** - Metric to SAE **G64** - International to International **G65** - Japanese Conversion **G73** - Ermento

**G 60**



Adapter Style

**110 -**



Thread Configuration  
(see below)

**08**



Stem Size

(Measured in 1/16" – 8/16 = 1/2")

**08**



Thread Size

(Measured in 1/16" – 8/16 = 1/2")

## THREAD CONFIGURATIONS

These three-digit numbers identify the various coupling thread configurations

- 60050** - FFN Female Flareless Nut
- 60051** - FFS Female Flareless Sleeve
- 60102** - MP-PLUG Male Pipe NPTF Plug
- 60110** - MP-MP Male Pipe NPTF to Male Pipe NPTF
- 60115** - MP-MP90 Male Pipe NPTF to Male Pipe NPTF - 90°
- 60130** - MP-FPS Male Pipe NPTF to Female Pipe NPTF Reducer Bushing - Short
- 60132** - MP-FPL Male Pipe NPTF to Female Pipe NPTF Increasing Bushing - Long
- 60134** - FP-MP45 Female Pipe NPTF to Male Pipe NPTF - 45°
- 60136** - MP-FP90 Male Pipe NPTF to Female Pipe NPTF - 90°
- 60140** - MP-FPX Male Pipe NPTF to Female Pipe Swivel NPSM
- 60142** - MP-FPX45 Male Pipe NPTF to Female Pipe Swivel NPSM - 45°
- 60144** - MP-FPX90 Male Pipe NPTF to Female Pipe Swivel NPSM - 90°
- 60152** - FP-FP Female Pipe NPTF to Female Pipe NPTF
- 60156** - FP-FP90 Female Pipe NPTF to Female Pipe NPTF - 90°
- 60160** - FP-FPX Female Pipe NPTF to Female Pipe Swivel NPSM
- 60162** - FP-FPX45 Female Pipe NPTF to Female Pipe Swivel NPSM - 45°
- 60164** - FP-FPX90 Female Pipe NPTF to Female Pipe Swivel NPSM - 90°
- 60181** - FP-FP-FP Female Pipe NPTF - Tee
- 60183** - FP-FP-MP Female Pipe NPTF on Run to Male Pipe NPTF - Tee
- 60184** - FPX-FPX-FPX Female Pipe Swivel NPSM - Tee
- 60186** - FPX-FPX-MP Female Pipe Swivel NPSM on Run to Male Pipe NPTF - Tee
- 60248** - O-RING O-Rings for Straight Thread Boss Fittings
- 60250** - MB-PLUG Male O-Ring Boss Plug
- 60265** - MB-MP Male O-Ring Boss to Male Pipe NPTF
- 60275** - MB-FP Male O-Ring Boss to Female Pipe NPTF
- 60285** - MB-FPX Male O-Ring Boss to Female Pipe Swivel NPSM
- 60287** - MB-FPX45 Male O-Ring Boss to Female Pipe Swivel NPSM - 45°
- 60289** - MB-FPX90 Male O-Ring Boss to Female Pipe Swivel NPSM - 90°
- 60291** - FB-MP Female O-Ring Boss to Male Pipe NPTF
- 60301** - MB-MJ Male O-Ring Boss to Male JIC 37° Flare
- 60308** - MB-MJ45 Male O-Ring Boss to Male JIC 37° Flare - 45°
- 60312** - MB-MJ90 Male O-Ring Boss to Male JIC 37° Flare - 90°
- 60320** - MB-FJX Male O-Ring Boss to Female JIC 37° Flare Swivel
- 60350** - MJ-MJ-MB Male JIC 37° Flare on Run to Male O-Ring Boss - Tee
- 60352** - MB-MJ-MJ Male O-Ring Boss to Male JIC 37° Flare to Male JIC 37° Flare - Tee
- 60394** - TS Tube Sleeve
- 60395** - TSN Tube Sleeve Nut
- 60399** - LN Locknuts for Bulkhead Fittings
- 60401** - FJ-CAP Female JIC 37° Flare Cap
- 60402** - MJ-PLUG Male JIC 37° Flare Plug
- 60405** - MJ-FBO Male JIC 37° Flare to Female Braze - On
- 60410** - MJ-MJ Male JIC 37° Flare to Male JIC 37° Flare
- 60417** - MJ-MJ90 Male JIC 37° Flare to Male JIC 37° Flare - 90°
- 60420** - MJ-FJ Male JIC 37° Flare to Female JIC 37° Flare
- 60422** - MJ-FJX90 Male JIC 37° Flare to Female JIC 37° Flare Swivel - 90°
- 60424** - MJ-FJX45 Male JIC 37° Flare to Female JIC 37° Flare Swivel - 45°
- 60445** - MJ-BKHD Male JIC 37° Flare to Male JIC 37° Flare Bulkhead
- 60446** - MJ-BKHD45 Male JIC 37° Flare to Male JIC 37° Flare Bulkhead - 45°
- 60447** - MJ-BKHD90 Male JIC 37° Flare to Male JIC 37° Flare Bulkhead - 90°
- 60469** - MJ-MJ-MJ Male JIC 37° Flare Tee
- 60470** - MJ-MJ-FJX Male JIC 37° Flare on Run to Female JIC 37° Flare Swivel - Tee
- 60471** - MJ-MJ-BKHD Male JIC 37° Flare on Run to Male JIC 37° Flare Bulkhead - Tee
- 60472** - MJ-BKHD-MJ Male JIC 37° Flare to Male JIC 37° Flare Bulkhead to Male JIC 37° Flare - Tee
- 60473** - MJ-FJX-MJ Male JIC 37° Flare to Female JIC 37° Flare Swivel to Male JIC 37° Flare - Tee
- 60490** - MJ-MP Male JIC 37° Flare to Male Pipe NPTF
- 60497** - MJ-MP45 Male JIC 37° Flare to Male Pipe NPTF - 45°
- 60499** - MJ-MP90 Male JIC 37° Flare to Male Pipe NPTF - 90°
- 60510** - MJ-FP Male JIC 37° Flare to Female Pipe NPTF
- 60514** - MJ-FP90 Male JIC 37° Flare to Female Pipe NPTF - 90°
- 60520** - FJX-MP Female JIC 37° Flare Swivel to Male Pipe NPTF
- 60524** - FJX-MP90 Female JIC 37° Flare Swivel to Male Pipe NPTF - 90°
- 60530** - FJX-FP Female JIC 37° Flare Swivel to Female Pipe NPTF
- 60541** - MJ-BKHD-MP Male JIC 37° Flare Bulkhead to Male Pipe NPTF
- 60551** - MJ-MJ-MP Male JIC 37° Flare on Run to Male Pipe NPTF - Tee
- 60698** - O-RING FF O-Rings for Flat-Face Fittings

EQUIPMENT
HOSE/CPLG. SELECTION
G8K COUPLINGS
GLOBAL SPIRAL COUPLINGS
STAINLESS STEEL SPIRAL
MEGACRIMP COUPLINGS
STAINLESS STEEL BRAID
POWER CRIMP COUPLINGS
FIELD ATTACHABLE G1 & G2 COUPLINGS
FIELD ATTACHABLE C5 COUPLINGS
C14 COUPLINGS
GL COUPLINGS
GLX COUPLINGS
PCTS THERMOPLASTIC COUPLINGS
POLARSEAL COUPLINGS (ACA)
POLARSEAL II COUPLINGS (ACC)
POLARSEAL II COUPLINGS (ACB)
POWER STEERING
ADAPTERS
QUICK DISCONNECT COUPLERS
BALL VALVES
LIVE SWIVEL
ASSEMBLY FABRICATION
ACCESSORIES
EQUIPMENT AND PARTS
KITS
AIR BRAKE HOSE ASSY
BRASS





## Adapters – Continued

EQUIPMENT
HOSE/CPLG. SELECTION
G8K COUPLINGS
GLOBAL SPIRAL COUPLINGS
STAINLESS STEEL SPIRAL
MEGACRIMP COUPLINGS
STAINLESS STEEL BRAID
POWER CRIMP COUPLINGS
FIELD ATTACHABLE G1 & G2 COUPLINGS
FIELD ATTACHABLE C5 COUPLINGS
C14 COUPLINGS
GL COUPLINGS
GLX COUPLINGS
PCTS THERMOPLASTIC COUPLINGS
POLARSEAL COUPLINGS (ACA)
POLARSEAL II COUPLINGS (ACC)
POLARSEAL II COUPLINGS (ACB)
POWER STEERING
ADAPTERS
QUICK DISCONNECT COUPLERS
BALL VALVES
LIVE SWIVEL
ASSEMBLY FABRICATION
ACCESSORIES
EQUIPMENT AND PARTS
KITS
AIR BRAKE HOSE ASSY
BRASS

<b>60701</b> - FFOR-CAP	Female Flat-Face O-Ring Cap	<b>60955</b> - FLH6K-MFFOR90	Code 62 O-Ring Flange Heavy to Male Flat-Face O-Ring 90° - (6,000 psi)
<b>60702</b> - MFFOR-PLUG	Male Flat-Face O-Ring Plug	<b>60959</b> - CATFHS	Caterpillar-Style Flange Half Sets
<b>60705</b> - MFFOR-MFFOR	Male Flat-Face O-Ring to Male Flat-Face O-Ring	<b>62150</b> - MBSPT-MJ	Male British Standard Pipe Tapered Thread to Male JIC 37° Flare
<b>60712</b> - MFFOR-MFFOR90	Male Flat-Face O-Ring to Male Flat-Face O-Ring - 90°	<b>62153</b> - MBSPT-MJ45	Male British Standard Pipe Tapered Thread to Male JIC 37° Flare - 45°
<b>60724</b> - MFFOR-FFORX90	Male Flat-Face O-Ring to Female Flat-Face Swivel - 90°	<b>62155</b> - MBSPT-MJ90	Male British Standard Pipe Tapered Thread to Male JIC 37° Flare - 90°
<b>60740</b> - MFFOR-MFFOR-MFFOR	Male Flat-Face O-Ring Tee	<b>62200</b> - MBSPP-MP	Male British Standard Pipe Parallel to Male Pipe NPTF
<b>60742</b> - MFFOR-MFFOR-FFORX	Male Flat-Face O-Ring on Run to Female Flat-Face Swivel Tee	<b>62220</b> - MBSPP-FP	Male British Standard Pipe Parallel to Female Pipe NPTF
<b>60744</b> - MFFOR-FFORX-MFFOR	Male Flat-Face O-Ring to Female Flat-Face O-Ring to Male Flat-Face O-Ring - Tee	<b>62300</b> - MBSPP-MJ	Male British Standard Pipe Parallel to Male JIC 37° Flare
<b>60770</b> - MFFOR-MP	Male Flat-Face O-Ring to Male Pipe NPTF	<b>62305</b> - MBSPP-MJ45	Male British Standard Pipe Parallel to Male JIC 37° Flare - 45°
<b>60785</b> - MFFOR-FJX	Male Flat-Face O-Ring to Female JIC 37° Flare Swivel	<b>62310</b> - MBSPP-MJ90	Male British Standard Pipe Parallel to Male JIC 37° Flare - 90°
<b>60800</b> - MFFOR-MB	Male Flat-Face O-Ring to Male O-Ring Boss	<b>62320</b> - MBSPP-FJX	Male British Standard Pipe Parallel to Female JIC 37° Flare Swivel
<b>60805</b> - MFFOR-MB45	Male Flat-Face O-Ring to Male O-Ring Boss - 45°	<b>62450</b> - MBSPPOR-MJ	Male British Standard Pipe Parallel with O-Ring to Male JIC 37° Flare
<b>60810</b> - MFFOR-MB90	Male Flat-Face O-Ring to Male O-Ring Boss - 90°	<b>62460</b> - MBSPPOR-MJ90	Male British Standard Pipe Parallel with O-Ring to Male JIC 37° Flare - 90°
<b>60811</b> - MFFOR-MB90L	Male Flat-Face O-Ring to Male O-Ring Boss - 90° Long Drop	<b>62470</b> - MBSPPOR-MFFOR	Male British Standard Pipe Parallel with O-Ring to Male Flat-Face O-Ring
<b>60820</b> - MFFOR-MFFOR-MB	Male Flat-Face O-Ring on Run to Male O-Ring Boss - Tee	<b>62471</b> - MBSPPOR-MFFORL	Male British Standard Pipe Parallel with O-Ring to Male Flat-Face O-Ring - Long
<b>60821</b> - MFFOR-MB-MFFOR	Male Flat-Face O-Ring to Male O-Ring Boss to Male Flat-Face O-Ring - Tee	<b>62473</b> - MBSPPOR-MFFOR45	Male British Standard Pipe Parallel with O-Ring to Male Flat-Face O-Ring - 45°
<b>60880</b> - FFORX-MJ	Female Flat-Face Swivel to Male JIC 37° Flare	<b>62475</b> - MBSPPOR-MFFOR90	Male British Standard Pipe Parallel with O-Ring to Male Flat-Face O-Ring - 90°
<b>60897</b> - FL-CAP	Code 61 Flange Cap	<b>62500</b> - FBSPP-MP	Female British Standard Pipe Parallel to Male Pipe NPTF
<b>60898</b> - FLANGE O-RING	O-Rings for Code 61, Code 62, and Caterpillar-Style Flange Fittings	<b>62520</b> - FBSPP-FP	Female British Standard Pipe Parallel to Female Pipe NPTF
<b>60899</b> - CFHS	Flange Half Sets (Code 61 - SAE J518)	<b>62550</b> - FBSPP-MJ	Female British Standard Pipe Parallel to Male JIC 37° Flare
<b>60900</b> - FL-MJ	Code 61 O-Ring Flange to Male JIC 37° Flare	<b>62605</b> - FBSPPX-MP90	Female British Standard Pipe Parallel Swivel to Male Pipe NPTF - 90°
<b>60901</b> - FL4K-MJ / FL5K-MJ	Code 61 O-Ring Flange to Male JIC 37° Flare - High Pressure	<b>62650</b> - FBSPPX-MJ	Female British Standard Pipe Parallel Swivel to Male JIC 37° Flare
<b>60905</b> - FL-MJ45	Code 61 O-Ring Flange to Male JIC 37° Flare - 45°	<b>62660</b> - FBSPPX-FJX	Female British Standard Pipe Parallel Swivel to Female JIC 37° Flare Swivel
<b>60906</b> - FL4K-MJ45 / FL5K-MJ45	Code 61 O-Ring Flange to Male JIC 37° Flare - 45° - High Pressure	<b>62801</b> - FBFFOR-MJ	Female British Flat-Face O-Ring to Male JIC 37° Flare
<b>60910</b> - FL-MJ90	Code 61 O-Ring Flange to Male JIC 37° Flare - 90°	<b>63099</b> - MMOR-PLUG	Male Metric O-Ring Plug
<b>60911</b> - FL4K-MJ90 / FL5K-MJ90	Code 61 O-Ring Flange to Male JIC 37° Flare - 90° - High Pressure	<b>63120</b> - MM-FP	Male Metric with O-Ring to Female Pipe NPTF
<b>60915</b> - FL4K-MFFOR / FL5K-MFFOR	Code 61 O-Ring Flange to Male Flat-Face O-Ring - High Pressure	<b>63150</b> - MM-MJ	Male Metric with O-Ring to Male JIC 37° Flare
<b>60920</b> - FL4K-MFFOR45 / FL5K-MFFOR45	Code 61 O-Ring Flange to Male Flat-Face O-Ring 45° - High Pressure	<b>63160</b> - MM-MJ90	Male Metric with O-Ring to Male JIC 37° Flare - 90°
<b>60925</b> - FL4K-MFFOR90 / FL5K-MFFOR90	Code 61 O-Ring Flange to Male Flat-Face O-Ring 90° - High Pressure	<b>63350</b> - MDL-MJ	Male DIN 24° Cone - Light Series to Male JIC 37° Flare
<b>60927</b> - FLH-CAP	Code 62 Flange Cap	<b>63450</b> - FDLX-MJ	Female DIN 24° Cone Swivel - Light Series to Male JIC 37° Flare
<b>60929</b> - FHHS	Flange Half Sets (Code 62 - SAE J518)	<b>63650</b> - MDH-MJ	Male DIN 24° Cone - Heavy Series to Male JIC 37° Flare
<b>60930</b> - FLH6K-MJ	Code 62 O-Ring Flange Heavy to Male JIC 37° Flare - (6,000 psi)	<b>63750</b> - FDHX-MJ	Female DIN 24° Cone Swivel - Heavy Series to Male JIC 37° Flare
<b>60935</b> - FLH6K-MJ45	Code 62 O-Ring Flange Heavy to Male JIC 37° Flare 45° - (6,000 psi)	<b>63980</b> - MKB-PLUG	Male Kobelco Plug
<b>60940</b> - FLH6K-MJ90	Code 62 O-Ring Flange Heavy to Male JIC 37° Flare 90° - (6,000 psi)	<b>63990</b> - MKB-MJ	Male Kobelco to Male JIC 37° Flare
<b>60945</b> - FLH6K-MFFOR	Code 62 O-Ring Flange Heavy to Male Flat-Face O Ring - (6,000 psi)	<b>64075</b> - BBDS	British Bonded Seal
<b>60950</b> - FLH6K-MFFOR45	Code 62 O-Ring Flange Heavy to Male Flat-Face O-Ring 45° - (6,000 psi)	<b>64094</b> - MBSPPOR-PLUG	Male British Standard Pipe Parallel with O-Ring Plug
		<b>64095</b> - O-RING FBSPP	O-Rings for British Standard Parallel Pipe (BSPP Couplings)
		<b>64097</b> - FBSPP-CAP	Female British Standard Pipe Parallel Cap



## Adapters – Continued

<b>64098</b>	- MBSPT-PLUG	Male British Standard Pipe Tapered Thread Plug
<b>64099</b>	- MBSPP-PLUG	Male British Standard Pipe Parallel Plug
<b>64350</b>	- MBSPP-FBSPPX	Male British Standard Pipe Parallel to Female British Standard Pipe Parallel Swivel
<b>64775</b>	- MBDS	Metric Bonded Seal
<b>64780</b>	- O-RING DIN L	O-Rings for DIN Light Series (MegaCrimp® and GlobalSpiral™ Couplings)
<b>64781</b>	- O-RING DIN H	O-Rings for DIN Heavy Series (PC, PCM, PCS Couplings)
<b>64790</b>	- MM-PLUG	Male Metric Plug
<b>64792</b>	- MDL-PLUG	Male DIN 24° Cone - Light Series Plug
<b>64793</b>	- FDL-CAP	Female DIN 24° Cone - Light Series Cap
<b>64794</b>	- MDH-PLUG	Male DIN 24° Cone - Heavy Series Plug
<b>64795</b>	- FDH-CAP	Female DIN 24° Cone - Heavy Series Cap
<b>65097</b>	- FJIS-CAP	Female Japanese Industrial Standard Cap
<b>65099</b>	- MJIS-PLUG	Male Japanese Industrial Standard Plug
<b>65100</b>	- FJIS-MJ	Female Japanese Industrial Standard to Male JIC 37° Flare
<b>65597</b>	- FK-CAP	Female Komatsu Cap
<b>65599</b>	- MK-PLUG	Male Komatsu Plug
<b>65600</b>	- FK-MJ	Female Komatsu to Male JIC 37° Flare
<b>65700</b>	- MK-MK	Male Komatsu to Male Komatsu
<b>65750</b>	- MK-MJ	Male Komatsu to Male JIC 37° Flare
<b>65800</b>	- MK-FK90	Male Komatsu to Female Komatsu - 90°
<b>65950</b>	- MK-FK-MK	Male Komatsu to Female Komatsu to Male Komatsu - Tee
<b>73050</b>	- ERBS	Bite Sleeve
<b>73060</b>	- ERTSN	Tube Sleeve Nut
<b>73100</b>	- ERT-MP	Ermeto to Male Pipe
<b>73104</b>	- ERT-MP90	Ermeto to Male Pipe - 90°
<b>73400</b>	- ERT-ERT	Ermeto to Ermeto

EQUIPMENT
HOSE/CPLG. SELECTION
G8K COUPLINGS
GLOBALSPIRAL COUPLINGS
STAINLESS STEEL SPIRAL
MEGACRIMP COUPLINGS
STAINLESS STEEL BRAID
POWER CRIMP COUPLINGS
FIELD ATTACHABLE G1 & G2 COUPLINGS
FIELD ATTACHABLE C5 COUPLINGS
C14 COUPLINGS
GL COUPLINGS
GLX COUPLINGS
PCTS THERMOPLASTIC COUPLINGS
POLARSEAL COUPLINGS (ACA)
POLARSEAL II COUPLINGS (ACC)
POLARSEAL II COUPLINGS (ACB)
POWER STEERING
ADAPTERS
QUICK DISCONNECT COUPLERS
BALL VALVES
LIVE SWIVEL
ASSEMBLY FABRICATION
ACCESSORIES
EQUIPMENT AND PARTS
KITS
AIR BRAKE HOSE ASSY
BRASS



## Quick Disconnect Couplers

Gates Quick Disconnect couplers feature a meaningful part number that makes coupling identification fast and easy. Always refer to Gates Cross Reference Charts when selecting a quick disconnect coupler for a competitive interchange.

# G94021-0808 D

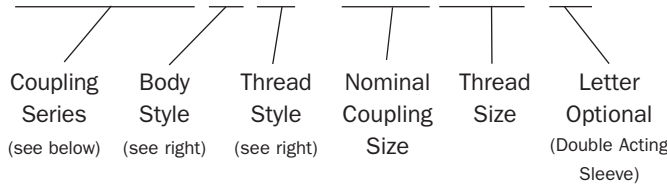

### BODY STYLE IDENTIFICATION

- 0 Assembly
- 1 Male Tip (Nipple)
- 2 Female Coupler
- 3 Repair Kit
- 5 O-Ring
- 6 Backup Ring
- 8 Dust Plug
- 9 Dust Cap

### THREAD STYLE

- 0 Not Applicable
- 1 Female Pipe
- 2 Female O-Ring Boss
- 3 Bulkhead Mounts
- 4 Female British Parallel Pipe

### MISCELLANEOUS

- D Double-Acting Sleeve
- P Connect-Under-Pressure Option

## COUPLING SERIES IDENTIFICATION

### G940 Series (Agriculture Standard-Ball Valve)

- G94** - 011 MQBA-FP Male Ball Valve to Female Pipe
- G94** - 012 MQBA-FB Male Ball Valve to Female O-Ring Boss
- G94** - 021 FQBA-FP Female Ball Valve To Female Pipe
- G94** - 021 FQBADA-FP Female Ball Valve To Female Pipe
- G94** - 022 FQBA-FB Female Ball Valve To Female O-Ring Boss
- G94** - 025 QDAOR O-Ring

### G940 and G941 Series (Agricultural)

- G94** - 080 QDADP QD Dust Plug
- G94** - 090 QDADC QD Dust Cap

### G941 Series (Agriculture Standard-Poppet Valve)

- G94** - 111 MQPA-FP Male Poppet Valve to Female Pipe
- G94** - 121 FQPA-FP Female Poppet Valve to Female Pipe

### G942 Series (John Deere Old Style)

- G94** - 211 MQBAJD-FP Male Ball Valve to Female Pipe
- G94** - 212 MQBAJD-FB Male Ball Valve to Female O-Ring Boss
- G94** - 221 FQBAJD-FP Female Ball Valve to Female Pipe

### G943 Series (International Harvester Old Style)

- G94** - 311 MQBAIHC-FP Male Tip - Ball Valve to Female Pipe

### G944 Series (J.I. Case Old Style)

- G94** - 411 MQBAJIC-FP Male Tip - Ball Valve to Female Pipe

### G945 Series (Industrial ISO 7241-1 - Series B)

- G94** - 511 MQPI-FP Male Poppet Valve to Female Pipe
- G94** - 521 FQPI-FP Female Poppet Valve to Female Pipe
- G94** - 525 QDIOR O-Ring
- G94** - 526 QDIBR Backup Ring
- G94** - 581 QDIDP/C QD Plug - Cap Combinations

### G949 Series (Flush Face - HTMA)

- G94** - 911 MQFF-FP Male Flush Face Valve to Female Pipe
- G94** - 912 MQFF-FB Male Flush Face Valve to Female O-Ring Boss
- G94** - 913 MQFF-BKHD Male Flush Face Valve to JIC 37° Flare Bulkhead
- G94** - 915 MQFF-FBPP Male Flush Face Valve to Female British Pipe Parallel
- G94** - 921 FQFF-FP Female Flush Face Valve to Female Pipe
- G94** - 922 FQFF-FB Female Flush Face Valve to Female O-Ring Boss
- G94** - 923 FQFF-BKHD Female Flush Face to JIC 37° Flare Bulkhead

- G94** - 925 FQFF-FBPP Female Flush Face Valve to Female British Pipe Parallel
- G94** - 980 QDFFDP Dust Plug
- G94** - 981 QDFFDP/C Dust Plug/Cap Combination
- G94** - 990 QDFFDC Dust Cap

### G950 Series (Flush Face - High Pressure)

- G95** - 011 MQFFH-FP Male Flush Face Valve
- G95** - 021 FQFFH-FP Female Flush Face Valve
- G95** - 080 QDFFHDP QD Dust Plug
- G95** - 081 QDFFHDP/C QD Plug - Cap Combination
- G95** - 090 QDFFHDC QD Dust Cap

### G951 Series (Wing Nut)

- G95** - 111 MQW-FP Male (Brass) - Less Flange
- G95** - 121 FQW-FP Female (Brass) - Wing Nut (Cast Iron)
- G95** - 180 QWDP Dust Plug
- G95** - 190 QWDC Dust Cap

### G952 Series (High Pressure Wing Nut)

- G95** - 211 MQWH-FP Male Acme Flat Threads to Female Pipe
- G95** - 221 FQWH-FP Female Wing Nut to Female Pipe
- G95** - 280 QWHDP Dust Plug
- G95** - 290 QWHDC Dust Cap

### G953 Series (Very High Pressure)

- G95** - 311 MQFFVH-FP Male Poppet Valve to Female Pipe
- G95** - 321 FQFFVH-FP Female Screw to Connect to Female Pipe

### G956 Series (Industrial ISO 7241 - Series A)

- G95** - 611 MQP-FP Male Poppet Valve to Female Pipe
- G95** - 621 FQP-FP Female Poppet Valve to Female Pipe
- G95** - 625 QDOR O-Ring
- G95** - 626 QDBR Backup Ring
- G95** - 680 QDDP QD Dust Plug
- G95** - 681 QDDP/C QD Plug - Cap Combination
- G95** - 690 QDDC QD Dust Cap

### G959 Series (Agriculture QD Adapters)

- G95** - 961 MJD-FISO John Deere Old Style to ISO Style
- G95** - 962 MISO-FJD ISO Style to John Deere Old Style
- G95** - 963 MIHC-FJD Int'l Harvester to John Deere Old Style
- G95** - 964 MIHC-FISO Int'l Harvester Old Style to ISO Style
- G95** - 965 MISO-FIHC ISO Style to Int'l Harvester Old Style
- G95** - 966 MISO-FJDDSO ISO Style to John Deere Old Style - (Double Shutoff)
- G95** - 967 MISO-FIHCDSO ISO Style to Int'l Harvester Old Style - (Double Shutoff)

EQUIPMENT
HOSE/CPLG. SELECTION
G8K COUPLINGS
GLOBAL SPIRAL COUPLINGS
STAINLESS STEEL SPIRAL
MEGACRIMP COUPLINGS
STAINLESS STEEL BRAID
POWER CRIMP COUPLINGS
FIELD ATTACHABLE G1 & G2 COUPLINGS
FIELD ATTACHABLE C5 COUPLINGS
C14 COUPLINGS
GL COUPLINGS
GLX COUPLINGS
PCTS THERMOPLASTIC COUPLINGS
POLARSEAL COUPLINGS (ACA)
POLARSEAL II COUPLINGS (ACC)
POLARSEAL II COUPLINGS (ACB)
POWER STEERING
ADAPTERS
QUICK DISCONNECT COUPLERS
BALL VALVES
LIVE SWIVEL
ASSEMBLY FABRICATION
ACCESSORIES
EQUIPMENT AND PARTS
KITS
AIR BRAKE HOSE ASSY
BRASS



## High Pressure Ball Valves

Gates Ball Valves feature a meaningful part number that makes coupling identification fast and easy.

# G96210-0808

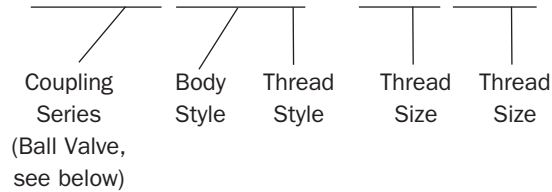

### BODY AND THREAD IDENTIFICATION

<b>110</b>	FP-FPBV	Female Pipe NPTF
<b>115</b>	FB-FBBV	Female O-Ring Boss
<b>120</b>	FP-FPBV	Female Pipe NPTF
<b>210</b>	FP-FP-FPBV	Female Pipe NPTF
<b>211</b>	FP-FP-FPBV	Female Pipe NPTF
<b>300</b>	FL-FLBV	Code 61 O-Ring Flange
<b>310</b>	FL-FLBV	Code 61 O-Ring Flange
<b>350</b>	FLH-FLHBV	Code 62 O-Ring Flange
<b>355</b>	FLH-FLHBV	Code 62 O-Ring Flange

## High Pressure Live Swivels

Gates Live Swivels feature a meaningful part number that makes coupling identification fast and easy.

# G93510-0808

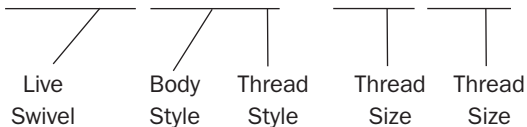

### BODY AND THREAD IDENTIFICATION

<b>340</b>	MP-FP-LX90	Male Pipe to Female Pipe - 90°
<b>345</b>	BSPP-BSPP-LX	Male BSPP to Male BSPP
<b>410</b>	MJ-MJ-LX	Male JIC to Male JIC
<b>415</b>	MJ-MJ-LX90	Male JIC to Male JIC - 90°
<b>420</b>	MJ-MJ-LX90S	Male JIC to Male JIC - 90°
<b>450</b>	MJ-FJ/FB-LX	Male JIC to Female JIC/Boss
<b>455</b>	MJ-FB-LX90	Male JIC to Female Boss - 90°
<b>460</b>	MB-FJ/FB-LX90S	Male Boss to Female JIC/Boss - 90°
<b>500</b>	JIC SWIVEL SEAL KIT	JIC Seal Kit
<b>510</b>	MJ-FP-LX	Male JIC to Female Pipe
<b>520</b>	MB-FP-LX90S	Male Boss to Female Pipe - 90°
<b>530</b>	MB-MJ-LX90S	Male Boss to Male JIC - 90°
<b>600</b>	ORS LIVE SWIVEL SEAL KIT	ORS Seal Kit
<b>700</b>	ORS/BSPP LIVE SWVL SEAL KIT	ORS/BSPP Seal Kit
<b>724</b>	MFFOR-FFORX-LX	Male ORFS to Female ORFS
<b>742</b>	MFFOR-MFFOR-LX	Male ORFS to Male ORFS

EQUIPMENT
HOSE/CPLG. SELECTION
G8K COUPLINGS
GLOBAL SPIRAL COUPLINGS
STAINLESS STEEL SPIRAL
MEGACRIMP COUPLINGS
STAINLESS STEEL BRAID
POWER CRIMP COUPLINGS
FIELD ATTACHABLE G1 & G2 COUPLINGS
FIELD ATTACHABLE C5 COUPLINGS
C14 COUPLINGS
GL COUPLINGS
GLX COUPLINGS
PCTS THERMOPLASTIC COUPLINGS
POLARSEAL COUPLINGS (ACA)
POLARSEAL II COUPLINGS (ACC)
POLARSEAL II COUPLINGS (ACB)
POWER STEERING
ADAPTERS
QUICK DISCONNECT COUPLERS
BALL VALVES
LIVE SWIVEL
ASSEMBLY FABRICATION
ACCESSORIES
EQUIPMENT AND PARTS
KITS
AIR BRAKE HOSE ASSY
BRASS



# GlobalSpiral™ (GS) Couplings

For EFG6K, EFG5K, EFG4K, EFG3K, and more Hose

EQUIPMENT
HOSE/CPLG. SELECTION
G8K COUPLINGS
GLOBALSPIRAL COUPLINGS
STAINLESS STEEL SPIRAL
MEGACRIMP COUPLINGS
STAINLESS STEEL BRAID
POWER CRIMP COUPLINGS
FIELD ATTACHABLE G1 & G2 COUPLINGS
FIELD ATTACHABLE C5 COUPLINGS
C14 COUPLINGS
GL COUPLINGS
GLX COUPLINGS
PCTS THERMOPLASTIC COUPLINGS
POLARSEAL COUPLINGS (ACA)
POLARSEAL II COUPLINGS (ACC)
POLARSEAL II COUPLINGS (ACB)
POWER STEERING
ADAPTERS
QUICK DISCONNECT COUPLERS
BALL VALVES
LIVE SWIVEL
ASSEMBLY FABRICATION
ACCESSORIES
EQUIPMENT AND PARTS
KITS
AIR BRAKE HOSE ASSY
BRASS

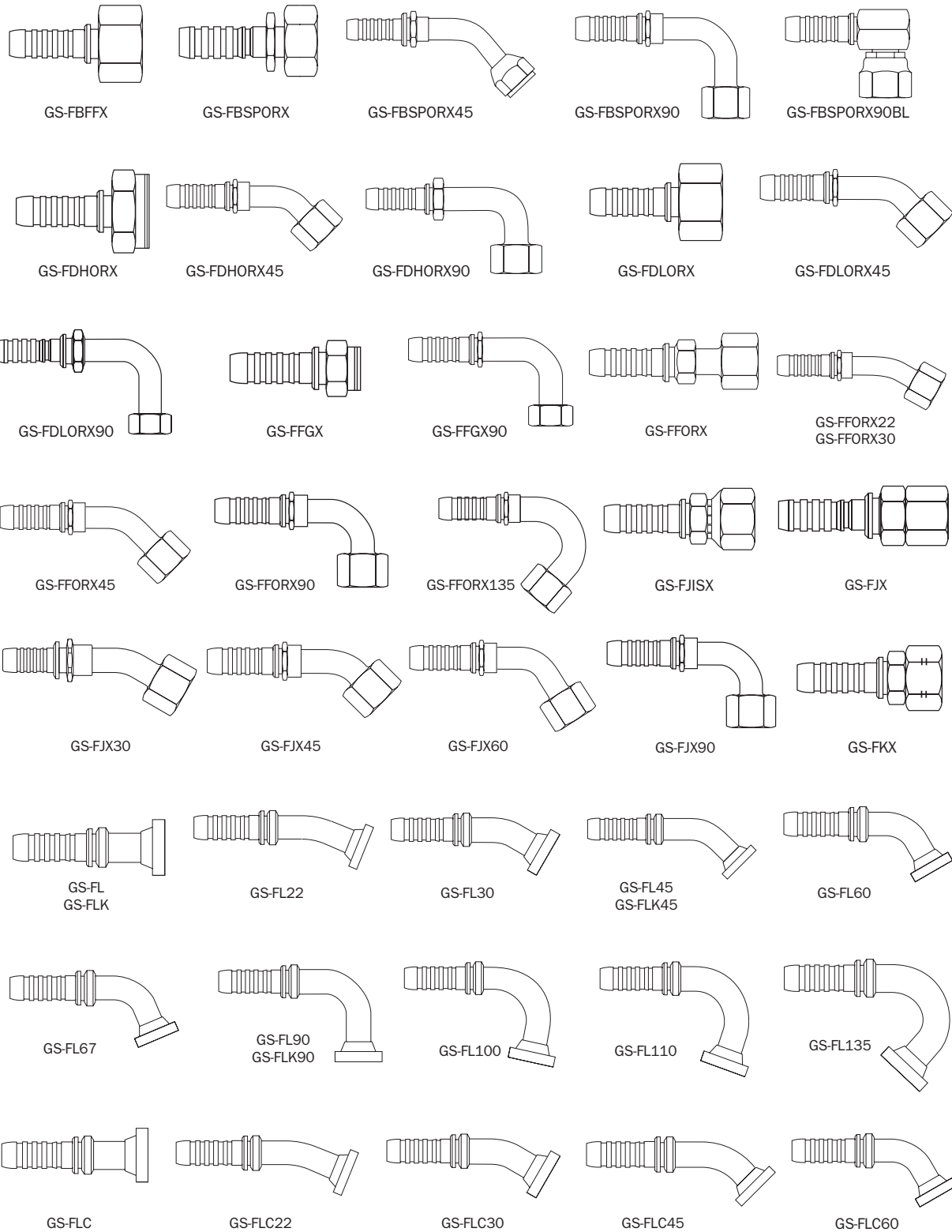



# GlobalSpiral™ (GS) Couplings

For EFG6K, EFG5K, EFG4K, EFG3K and more Hose-Continued

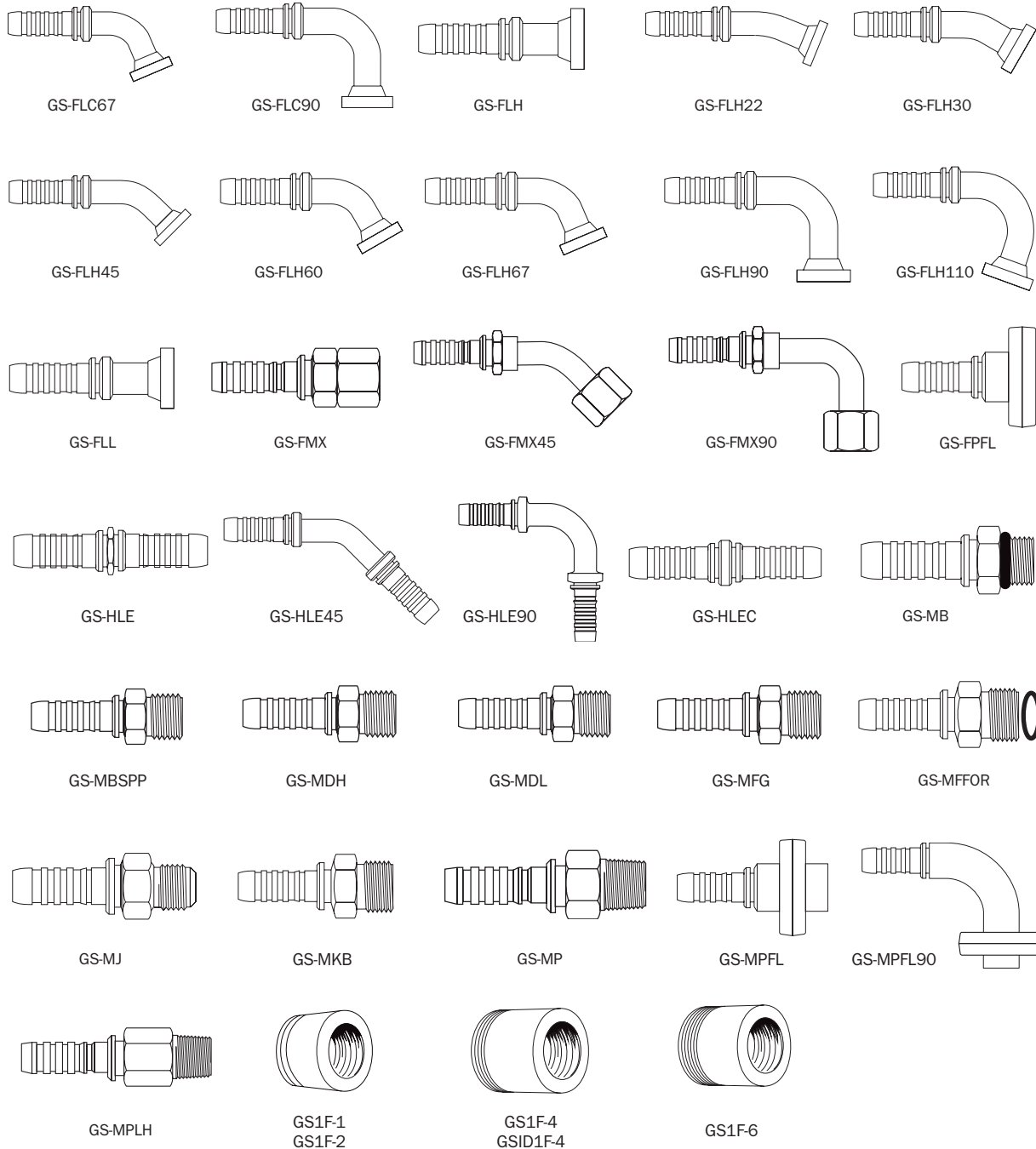

EQUIPMENT
HOSE/CPLG. SELECTION
G8K COUPLINGS
GLOBALSPIRAL COUPLINGS
STAINLESS STEEL SPIRAL
MEGACRIMP COUPLINGS
STAINLESS STEEL BRAID
POWER CRIMP COUPLINGS
FIELD ATTACHABLE G1 & G2 COUPLINGS
FIELD ATTACHABLE C5 COUPLINGS
C14 COUPLINGS
GL COUPLINGS
GLX COUPLINGS
PCTS THERMOPLASTIC COUPLINGS
POLARSEAL COUPLINGS (ACA)
POLARSEAL II COUPLINGS (ACC)
POLARSEAL II COUPLINGS (ACB)
POWER STEERING
ADAPTERS
QUICK DISCONNECT COUPLERS
BALL VALVES
LIVE SWIVEL
ASSEMBLY FABRICATION
ACCESSORIES
EQUIPMENT AND PARTS
KITS
AIR BRAKE HOSE ASSY
BRASS





## GlobalSpiral™ (GS) Couplings

One-Piece Couplings for Use with MobileCrimp® Crimpers for EFG6K, EFG5K, EFG4K, EFG3K and more Hose

EQUIPMENT
HOSE/CPLG. SELECTION
G8K COUPLINGS
GLOBALSPIRAL COUPLINGS
STAINLESS STEEL SPIRAL
MEGACRIMP COUPLINGS
STAINLESS STEEL BRAID
POWER CRIMP COUPLINGS
FIELD ATTACHABLE G1 & G2 COUPLINGS
FIELD ATTACHABLE C5 COUPLINGS
C14 COUPLINGS
GL COUPLINGS
GLX COUPLINGS
PCTS THERMOPLASTIC COUPLINGS
POLARSEAL COUPLINGS (ACA)
POLARSEAL II COUPLINGS (ACC)
POLARSEAL II COUPLINGS (ACB)
POWER STEERING
ADAPTERS
QUICK DISCONNECT COUPLERS
BALL VALVES
LIVE SWIVEL
ASSEMBLY FABRICATION
ACCESSORIES
EQUIPMENT AND PARTS
KITS
AIR BRAKE HOSE ASSY
BRASS

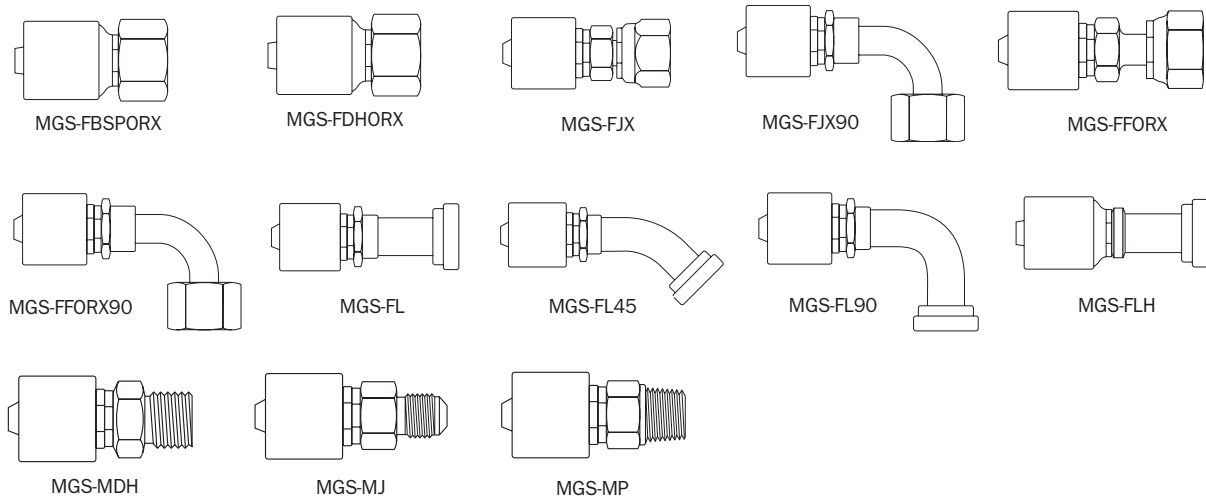

## MegaCrimp® Couplings

For High and Medium Pressure Hose

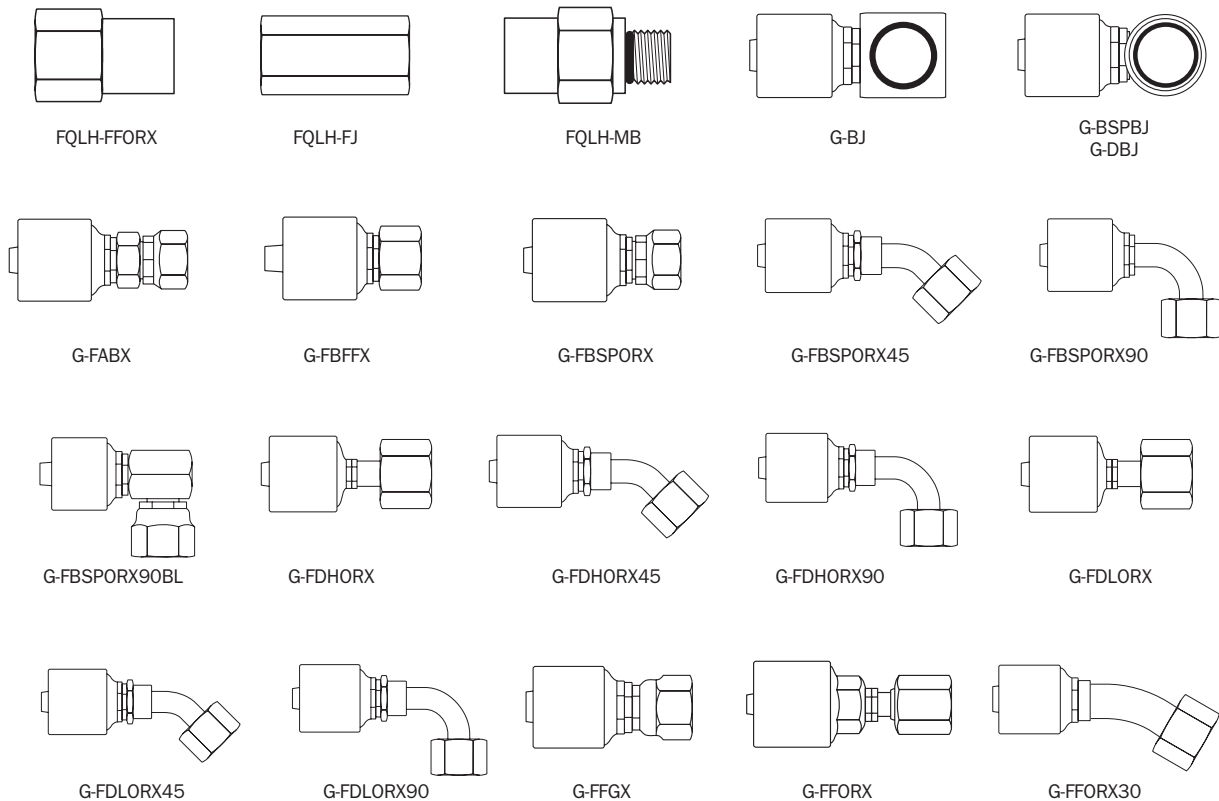



# MegaCrimp® Couplings - Continued

For High And Medium Pressure Hose-Continued

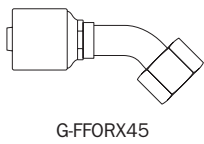

G-FFORX45

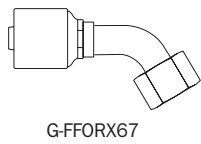

G-FFORX67

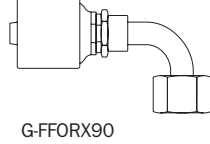

G-FFORX90

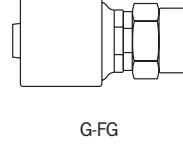

G-FG

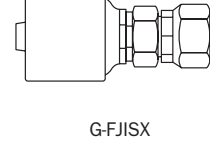

G-FJISX

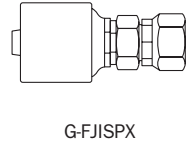

G-FJISPX

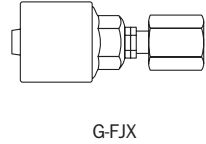

G-FJX

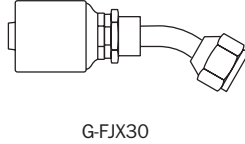

G-FJX30

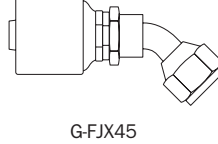

G-FJX45

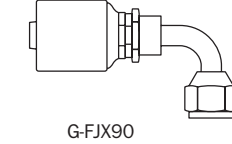

G-FJX90

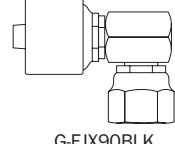

G-FJX90BLK

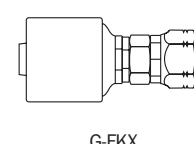

G-FKX

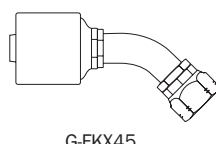

G-FKX45

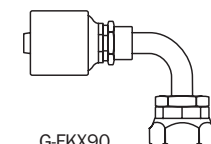

G-FKX90

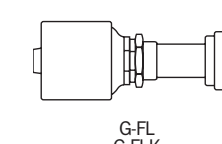

G-FL  
G-FLK

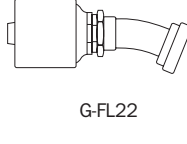

G-FL22

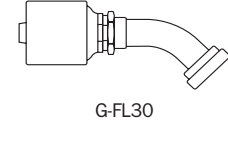

G-FL30

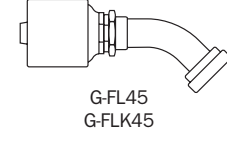

G-FL45  
G-FLK45

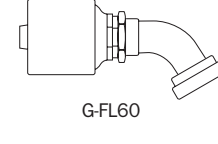

G-FL60

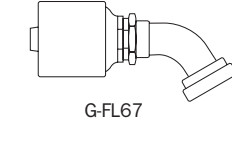

G-FL67

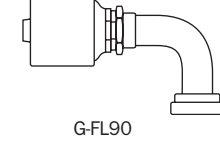

G-FL90  
G-FLK90

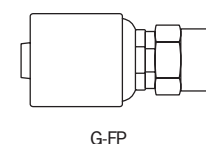

G-FP

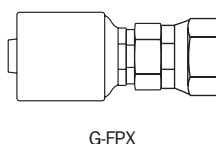

G-FPX

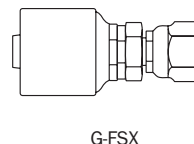

G-FSX

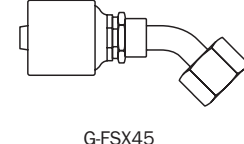

G-FSX45

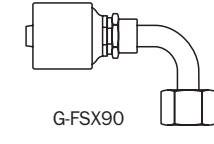

G-FSX90

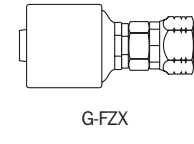

G-FZX

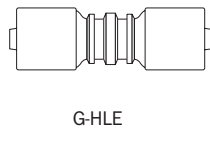

G-HLE

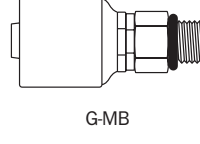

G-MB

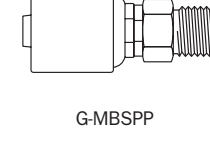

G-MBSPP

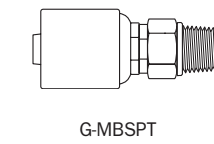

G-MBSPT

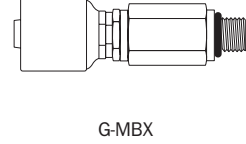

G-MBX

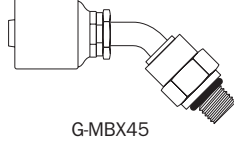

G-MBX45

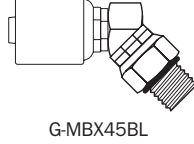

G-MBX45BL

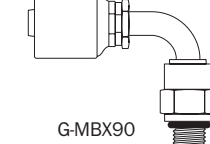

G-MBX90

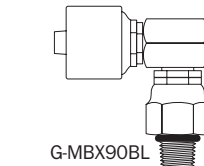

G-MBX90BL

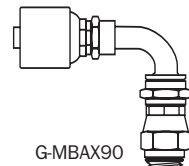

G-MBAX90

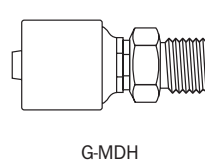

G-MDH

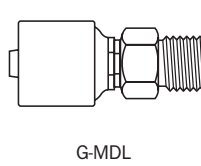

G-MDL

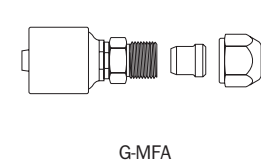

G-MFA

EQUIPMENT
HOSE/CPLG. SELECTION
G8K COUPLINGS
GLOBALSPIRAL COUPLINGS
STAINLESS STEEL SPIRAL
MEGACRIMP COUPLINGS
STAINLESS STEEL BRAID
POWER CRIMP COUPLINGS
FIELD ATTACHABLE G1 & G2 COUPLINGS
FIELD ATTACHABLE C5 COUPLINGS
C14 COUPLINGS
GL COUPLINGS
GLX COUPLINGS
PCTS THERMOPLASTIC COUPLINGS
POLARSEAL COUPLINGS (ACA)
POLARSEAL II COUPLINGS (ACC)
POLARSEAL II COUPLINGS (ACB)
POWER STEERING
ADAPTERS
QUICK DISCONNECT COUPLERS
BALL VALVES
LIVE SWIVEL
ASSEMBLY FABRICATION
ACCESSORIES
EQUIPMENT AND PARTS
KITS
AIR BRAKE HOSE ASSY
BRASS



# MegaCrimp® Couplings - Continued

For High And Medium Pressure Hose-Continued

EQUIPMENT
HOSE/CPLG. SELECTION
G8K COUPLINGS
GLOBAL SPIRAL COUPLINGS
STAINLESS STEEL SPIRAL
MEGACRIMP COUPLINGS
STAINLESS STEEL BRAID
POWER CRIMP COUPLINGS
FIELD ATTACHABLE G1 & G2 COUPLINGS
FIELD ATTACHABLE C5 COUPLINGS
C14 COUPLINGS
GL COUPLINGS
GLX COUPLINGS
PCTS THERMOPLASTIC COUPLINGS
POLARSEAL COUPLINGS (ACA)
POLARSEAL II COUPLINGS (ACC)
POLARSEAL II COUPLINGS (ACB)
POWER STEERING
ADAPTERS
QUICK DISCONNECT COUPLERS
BALL VALVES
LIVE SWIVEL
ASSEMBLY FABRICATION
ACCESSORIES
EQUIPMENT AND PARTS
KITS
AIR BRAKE HOSE ASSY
BRASS

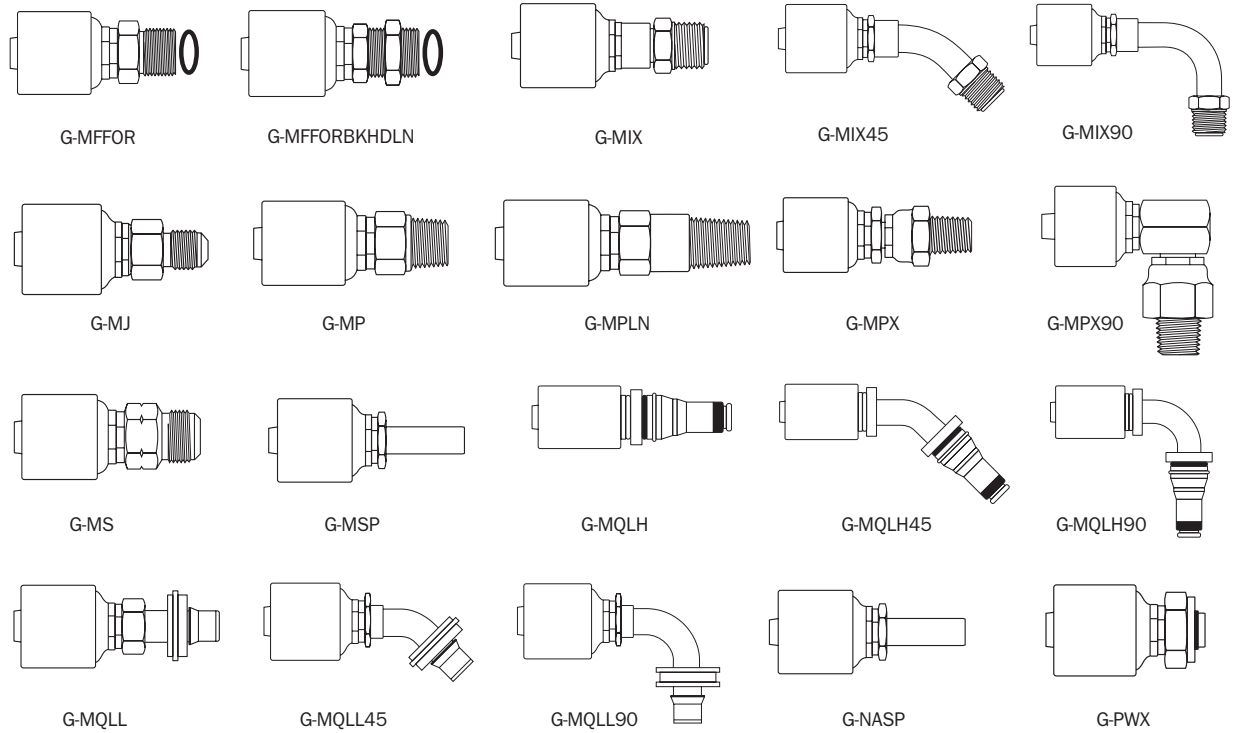



# CHEMICAL RESISTANCE RATINGS FOR GATES HOSE POLYMERS, COUPLINGS AND ADAPTER MATERIALS

The Chemical Resistance Table lists the relative resistance of hose and coupling materials to more common chemicals. These ratings do not cover all possible variations of all factors, such as temperature, concentration, degradation or fluid contamination, etc. Testing under actual conditions is the best way to ensure chemical compatibility for critical applications.

**For specific information, contact Gates Hose/Connector Product Application, Denver, Colorado 303-744-5070.**

Rating Scale	
“1”	Excellent resistance
“2”	Good resistance
“X”	Not recommended
“—”	Testing recommended

## HOW TO USE THE CHEMICAL RESISTANCE TABLE

1. Chemicals are listed alphabetically.
2. Find the hose, coupling and adapter material type that has a resistance rating of “1” or “2” (See Rating Scale).
3. Find hose with compatible polymer(s) in the Gates Hydraulic Hose Selection Guide.
4. Look for compatible couplings for the selected hose by following the hose page references in the Selection Guide.

**NOTE:** O-rings used with couplings also must be considered for chemical compatibility with the fluid to be conveyed. This includes couplings containing internal o-rings; for example, MPX (Male Pipe Swivel). Gates standard o-ring is made of Nitrile. If o-rings other than Nitrile are required, contact Gates Hose/Connector Product Application.

EQUIPMENT
HOSE/CPLG. SELECTION
G8K COUPLINGS
GLOBALSPIRAL COUPLINGS
STAINLESS STEEL SPIRAL
MEGACRIMP COUPLINGS
STAINLESS STEEL BRAID
POWER CRIMP COUPLINGS
FIELD ATTACHABLE G1 & G2 COUPLINGS
FIELD ATTACHABLE C5 COUPLINGS
C14 COUPLINGS
GL COUPLINGS
GLX COUPLINGS
PCTS THERMOPLASTIC COUPLINGS
POLARSEAL COUPLINGS (ACA)
POLARSEAL II COUPLINGS (ACC)
POLARSEAL II COUPLINGS (ACB)
POWER STEERING
ADAPTERS
QUICK DISCONNECT COUPLERS
BALL VALVES
LIVE SWIVEL
ASSEMBLY FABRICATION
ACCESSORIES
EQUIPMENT AND PARTS
KITS
AIR BRAKE HOSE ASSY
BRASS











CHEMICAL RESISTANCE TABLE - CONTINUED

Rating Scale: 1 Excellent 2 Good resistance X Not recommended - Testing recommended [ ] Cover stock rating only; Rating for tube stock "X" * Use Gates fuel hose or contact Denver Product Application Department	Gates Hose Polymers							Couplings & Adapters							
	Polychloroprene Nitrile, HNBR, or XTF	Nitrile + PVC	CPE	CSM	Urethane	PTFE	Nylon	MegaTuff	Carbon Steel	Stainless Steel 304	Stainless Steel 316	Aluminum	Brass		
Chemical Name															
Ethyl Acetate	X	X	X	2	X	2	1	1	1	1	2	2			
Ethyl Acetoacetate	X	X	X	1	X	X	1	-	-	1	1	1	1		
Ethyl Acrylate	X	X	X	2	X	X	1	-	-	1	1	1	-		
Ethyl Alcohol	1	1	1	1	-	-	1	1	1	1	1	2			
Ethyl Amine, Monoethylamine	X	X	X	1	X	X	1	-	-	2	1	1	2	1	
Ethyl Benzene	X	X	X	2	X	1	1	-	-	1	1	1	1	1	
Ethyl Bromide, Di	X	X	X	2	X	1	-	-	-	1	1	1	1	1	
Ethyl Butyrate	X	X	X	-	-	-	1	-	-	-	1	1	1	-	
Ethyl Cellulose	-	-	-	1	-	-	1	-	-	1	1	1	-	1	
Ethyl Chloride	X	X	X	-	X	1	-	-	-	2	1	1	1	2	
Ethyl Ether	X	X	X	-	1	-	1	-	-	2	1	1	1	1	
Ethyl Mercaptan	X	X	X	-	X	X	1	-	-	2	-	-	-	-	
Ethyl Oxalate	X	X	-	1	X	X	1	-	-	-	-	-	-	-	
Ethyl Pentachlorobenzene	-	X	-	X	-	1	1	-	-	2	1	1	-	1	
Ethyl Silicate	1	1	1	-	1	1	1	-	-	1	1	1	1	1	
Ethylene Chloride	X	X	X	X	-	1	1	X	-	-	1	1	-	2	
Ethylene Chlorohydrin, Under 100°F	X	X	X	-	-	X	1	X	-	-	1	1	2	X	-
Ethylene Diamine (Under 100°F)	2	2	2	1	X	X	1	-	-	-	-	-	-	1	-
Ethylene Dichloride	X	X	X	X	-	1	1	X	-	-	1	1	X	2	-
Ethylene Glycol	1	1	1	1	1	1	1	1	1	1	1	1	1	1	1

\*\*Nitrile 150°F or less, no constant contact.

Rating Scale: 1 Excellent 2 Good resistance X Not recommended - Testing recommended [ ] Cover stock rating only; Rating for tube stock "X" * Use Gates fuel hose or contact Denver Product Application Department	Gates Hose Polymers							Couplings & Adapters							
	Polychloroprene Nitrile, HNBR, or XTF	Nitrile + PVC	CPE	CSM	Urethane	PTFE	Nylon	MegaTuff	Carbon Steel	Stainless Steel 304	Stainless Steel 316	Aluminum	Brass		
Chemical Name															
Fusel Oil, Grain Oil	X	X	-	-	-	-	1	-	1	-	-	-	-	-	-
Fyrguard 150, 200	-	1	-	-	-	-	1	-	-	1	1	1	1	1	1
Fyrquel A60, 90, 100, 150, 220, 300, 500	X	X	-	-	-	-	1	-	-	1	-	-	1	-	-
Fyrquel 1000, 15R&O, 220R&O, 550R&O	X	X	-	-	-	-	1	-	-	1	-	-	1	-	-

**G**

Gallic Acid (Under 100°F)	X	X	X	1	-	X	1	2	1	X	1	1	X	-	-
Gas, Natural	-	-	-	X	-	-	1	-	-	1	1	1	-	2	-
Gasohol	2	*	*	-	X	-	1	-	1	2	1	1	1	1	1
Gasoline, Aviation	X	-	2	-	-	-	1	-	1	-	1	1	1	1	1
Gasoline, Meter	X	*	-	-	-	-	1	X	1	1	1	1	1	X	-
Gasoline, Premium	[2]	*	*	-	X	X	1	-	1	2	1	1	1	1	1
Gasoline, Sour	X	X	-	-	-	-	1	-	-	2	1	1	X	-	-
Gasoline, Standard	[1]	*	*	2	X	X	1	-	1	2	1	1	1	1	1
Gasoline, Unleaded Under 50% Aromatics	X	*	X	-	X	X	1	-	1	2	1	1	1	1	1
Gelatin	1	1	-	-	-	-	1	1	-	X	1	1	1	-	-
Glauber's Salt	2	X	-	-	-	-	1	-	-	1	1	1	-	-	-
Glucose	1	1	1	-	1	1	1	-	-	1	1	1	1	1	1
Glue (Under 120°F)	2	2	2	-	1	1	1	2	-	2	1	1	2	X	-
Glycerine, Glycerol	1	1	1	1	1	1	1	1	1	2	1	1	1	2	-
Glycol FR Fluids	-	1	-	-	-	-	1	-	-	1	1	1	1	1	1
Glycols (Under 120°F)	1	1	1	1	1	1	1	1	2	2	1	1	1	1	1
Grease, Ester Base	-	-	-	-	-	-	1	1	-	1	1	1	1	1	1
Grease, Petroleum Base	2	1	2	-	2	1	1	1	2	1	1	1	1	1	1
Grease, Silicone Base	-	-	-	-	-	-	1	1	1	1	1	1	1	1	1
Green Sulfate Liquor, Under 100°F	2	2	1	2	1	-	1	-	1	1	1	1	-	-	-
Gulf FR Fluid G-200	-	1	-	-	-	-	X	1	-	-	1	1	1	1	1
Gulf FR Fluid P37, P40, P43, P45, P47	-	X	-	-	-	-	X	1	-	-	-	-	-	-	-

**H**

Halowax Oil	X	X	X	-	X	-	1	-	1	-	-	-	-	-	-
Heptachlor, In Petroleum	-	2	X	-	-	-	1	-	-	-	-	-	-	-	-
Heptane (Under 100°F)	[2]	1	[2]	1	X	1	1	1	1	1	1	1	1	1	1
N-Hexaldehyde	2	X	2	-	-	-	1	-	1	-	1	1	1	1	1
Hexane (Under 120°F)	[2]	1	[2]	2	1	1	1	1	1	1	1	1	1	1	1
Hexene	[2]	2	-	1	-	-	1	-	1	-	1	1	1	-	1
Hexyl Alcohol	1	2	1	1	-	-	1	-	-	1	1	1	1	2	2
High Viscosity Lubricant, U4	2	1	-	-	-	-	1	-	-	-	-	-	-	-	-
High Viscosity Lubricant, H2	2	1	-	-	-	-	1	-	-	-	-	-	-	-	-
Hilo MS #1	X	X	-	-	-	-	-	-	-	-	-	-	-	-	-
Houghto-Safe 1010,1055 (Phos. Ester)	X	X	X	1	X	-	1	-	-	-	1	1	1	1	1
Houghto-Safe 1115, 1120, 1130 (Phos. Ester)	X	X	X	1	X	-	1	-	-	-	1	1	1	1	1
Houghto-Safe 271, 416, 520, 616 (Water/Glycol)	2	1	1	-	-	-	2	1	-	-	1	1	1	1	1
Houghto-Safe 620, 625, 640, 525 (Water/Glycol)	1	1	1	-	-	-	2	1	-	-	1	1	1	1	1
Houghto-Safe 5046, 5046W (Water/Oil Emulsion)	2	1	-	-	-	-	1	-	-	-	1	1	1	1	1
Hy-Chock Oil	-	1	-	-	-	-	-	1	1	-	1	1	1	-	-
Hydrafluid 760, Texaco and Houghton	-	1	-	-	-	-	-	1	1	-	1	1	1	-	1
Hydrafluid AZR&O, A, B, AA, C	-	1	-	-	-	-	-	1	1	-	1	1	1	-	1
Hydralol A	-	1	-	-	-	-	-	1	1	-	1	1	1	-	-
Hydraulic Fluid, Phosphate Ester Base	X	X	X	1	-	X	1	1	-	-	1	1	1	-	-

EQUIPMENT
HOSE/CPLG. SELECTION
G8K COUPLINGS
GLOBAL SPIRAL COUPLINGS
STAINLESS STEEL SPIRAL
MEGACRIMP COUPLINGS
STAINLESS STEEL BRAID
POWER CRIMP COUPLINGS
FIELD ATTACHABLE G1 & G2 COUPLINGS
FIELD ATTACHABLE C5 COUPLINGS
C14 COUPLINGS
GL COUPLINGS
GLX COUPLINGS
PCTS THERMOPLASTIC COUPLINGS
POLARSEAL COUPLINGS (ACA)
POLARSEAL II COUPLINGS (ACC)
POLARSEAL II COUPLINGS (ACB)
POWER STEERING
ADAPTERS
QUICK DISCONNECT COUPLERS
BALL VALVES
LIVE SWIVEL
ASSEMBLY FABRICATION
ACCESSORIES
EQUIPMENT AND PARTS
KITS
AIR BRAKE HOSE ASSY
BRASS

CHEMICAL RESISTANCE TABLE – CONTINUED



EQUIPMENT	Rating Scale: 1 Excellent 2 Good resistance X Not recommended - Testing recommended [ ] Cover stock rating only; Rating for tube stock "X"	Gates Hose Polymers							Couplings & Adapters				
		Polychloroprene Nitrile, HNBR, or XTF	Nitrile + PVC	CPE	CSM	Urethane	PTFE	Nylon	MegaTuff	Carbon Steel	Stainless Steel 304	Stainless Steel 316	Aluminum
HOSE/CPLG. SELECTION													
G8K COUPLINGS													
GLOBAL SPIRAL COUPLINGS													
STAINLESS STEEL SPIRAL													
MEGACRIMP COUPLINGS													
STAINLESS STEEL BRAID													
POWER CRIMP COUPLINGS													
FIELD ATTACHABLE G1 & G2 COUPLINGS													
FIELD ATTACHABLE C5 COUPLINGS													
C14 COUPLINGS													
GL COUPLINGS													
GLX COUPLINGS													
PCTS THERMOPLASTIC COUPLINGS													
POLARSEAL COUPLINGS (ACA)													
POLARSEAL II COUPLINGS (ACC)													
POLARSEAL II COUPLINGS (ACB)													
POWER STEERING													
ADAPTERS													
QUICK DISCONNECT COUPLERS													
BALL VALVES													
LIVE SWIVEL													
ASSEMBLY FABRICATION													
ACCESSORIES													
EQUIPMENT AND PARTS													
KITS													
AIR BRAKE HOSE ASSY													
BRASS													

\*\*Nitrile 150°F or less, no constant contact.

EQUIPMENT	Rating Scale: 1 Excellent 2 Good resistance X Not recommended - Testing recommended [ ] Cover stock rating only; Rating for tube stock "X"	Gates Hose Polymers							Couplings & Adapters				
		Polychloroprene Nitrile, HNBR, or XTF	Nitrile + PVC	CPE	CSM	Urethane	PTFE	Nylon	MegaTuff	Carbon Steel	Stainless Steel 304	Stainless Steel 316	Aluminum
HOSE/CPLG. SELECTION													
G8K COUPLINGS													
GLOBAL SPIRAL COUPLINGS													
STAINLESS STEEL SPIRAL													
MEGACRIMP COUPLINGS													
STAINLESS STEEL BRAID													
POWER CRIMP COUPLINGS													
FIELD ATTACHABLE G1 & G2 COUPLINGS													
FIELD ATTACHABLE C5 COUPLINGS													
C14 COUPLINGS													
GL COUPLINGS													
GLX COUPLINGS													
PCTS THERMOPLASTIC COUPLINGS													
POLARSEAL COUPLINGS (ACA)													
POLARSEAL II COUPLINGS (ACC)													
POLARSEAL II COUPLINGS (ACB)													
POWER STEERING													
ADAPTERS													
QUICK DISCONNECT COUPLERS													
BALL VALVES													
LIVE SWIVEL													
ASSEMBLY FABRICATION													
ACCESSORIES													
EQUIPMENT AND PARTS													
KITS													
AIR BRAKE HOSE ASSY													
BRASS													

\*\*Nitrile 150°F or less, no constant contact.



# CHEMICAL RESISTANCE TABLE - CONTINUED

Rating Scale: 1 Excellent 2 Good resistance X Not recommended - Testing recommended [ ] Cover stock rating only; Rating for tube stock "X" * Use Gates fuel hose or contact Denver Product Application Department	Gates Hose Polymers							Couplings & Adapters					
	Polychloroprene Nitrile, HNBR, or XTF	Nitrile + PVC	CPE	CSM	Urethane	PTFE	Nylon	MegaTuff	Carbon Steel	Stainless Steel 304	Stainless Steel 316	Aluminum	Brass
Magnesium Sulfate	2	2	2	1	1	1	1	1	2	2	2	2	2
Malathion (Ag Spray Dilute)	-	2	-	-	-	-	-	1	1	1	1	-	1
Maleic Acid	2	X	-	-	-	-	-	1	2	2	1	-	-
Malic Acid	-	-	-	-	-	-	1	-	2	2	1	-	-
Manganese Salts	-	1	1	-	1	-	-	-	-	-	-	-	-
Maxmul (Penzoi Hydraulic Fluid)	2	1	2	-	-	-	1	-	1	-	1	-	-
Mercuric Chloride	1	2	2	1	1	2	1	X	X	1	1	X	X
Mercuric Cyanide	1	2	2	-	1	-	-	-	2	2	2	X	-
Mercurous Nitrate (Under 120°F)	1	2	2	-	1	-	1	-	1	1	1	X	-
Mercury	1	2	2	1	1	2	1	1	1	1	1	X	X
Mesityl Oxide	X	X	X	2	X	X	1	-	1	1	1	1	1
Methane	2	1	-	-	-	-	1	-	-	1	1	-	-
Methoxychlor (Insecticide)	-	-	-	-	-	-	1	X	-	1	1	1	-
Methyl Acetate	X	X	X	1	X	-	1	-	1	1	1	1	1
Methyl Acrylate	X	X	X	-	X	-	1	-	1	1	1	1	1
Methyl Alcohol	1	1	1	1	-	-	1	1	1	1	1	2	-
Methyl Amine (25% Aqueous Solution)	2	X	-	-	-	-	1	-	1	1	1	1	-
Methyl Amine (60%)	2	2	-	-	-	-	1	2	1	1	1	1	2
Methyl Amine (99%)	X	X	-	-	-	-	1	-	1	1	1	1	X
Methyl Bromide	X	X	X	-	X	X	1	1	-	1	1	X	1
Methyl Butyl Ketone (MBK)	X	X	X	2	X	-	1	-	1	1	1	1	1
Methyl Cellosolve (Under 100°F)	2	X	-	1	X	-	1	-	2	2	2	2	1
Methyl Chloride	X	X	X	X	X	-	1	1	-	1	1	1	-
Methyl Ethyl Ketone (MEK)	X	X	X	2	X	X	1	1	1	1	1	2	1
Methyl Formate	2	X	X	-	X	-	1	-	2	1	1	1	1
Methyl Isobutyl Ketone (MIBK, 100°F)	X	X	X	2	X	X	1	1	-	1	1	1	1
Methyl Isopropyl Ketone	X	X	X	2	X	X	1	1	-	1	1	1	1
Methyl Methacrylate	X	X	X	2	2	-	1	-	2	2	2	-	-
Methyl Salicylate	2	2	2	-	-	-	1	-	1	1	1	1	1
Methyl Sulfate (Dimethyl, Under 100°F)	X	X	X	-	X	1	1	1	-	1	1	1	-
Methylene Chloride	X	X	X	X	X	-	1	X	2	1	1	X	1
Methylene Dichloride	X	X	X	-	-	-	1	1	-	1	1	X	1
Mineral Oil (Under 120°F)	1	1	1	1	1	1	1	1	1	1	2	1	1
Mineral Spirits	-	1	2	-	X	-	1	-	1	1	1	2	1
Mobile Therm 603	-	1	-	-	-	-	1	-	1	1	1	1	1
Molasses (Under 120°F)	2	2	2	-	1	1	1	-	2	1	2	X	-
Monochlorobenzene	X	X	X	X	X	1	-	-	1	1	1	X	1
Monoethanolamine	X	2	-	1	X	-	1	-	1	1	1	2	1
Morpholine (Pure Additive)	-	-	-	-	-	-	1	-	-	1	1	-	-
Motor Oils (Under 135°F)	2	1	2	1	2	2	1	1	-	1	1	1	1
Mould Oil	-	-	-	-	-	-	1	-	*	1	1	-	-
Muriatic Acid (Hydrochloric)	X	X	X	1	2	X	1	X	1	X	X	X	X
Mustard	1	2	1	-	1	-	1	-	X	1	1	2	-
<b>N</b>													
Naphtha (Low Aromatic Content)	X	2	X	1	X	-	1	1	-	2	1	1	1
Naphthalene (Tar Camphor)	X	X	X	1	X	-	1	1	-	1	1	1	1
Naphthalene	X	X	X	-	X	-	1	-	-	1	1	1	-
Naphthenic Acid	-	2	-	-	-	-	1	-	-	2	1	-	-
Natural Gas	-	-	-	-	-	-	1	-	X	1	1	-	2
Nickel Acetate solution (in water or alcohol)	-	-	-	-	-	-	1	-	1	1	1	1	1
Nickel Chloride	2	2	2	1	2	-	1	1	-	1	1	1	1
Nickel Nitrate	2	2	2	1	2	-	1	1	-	2	2	X	-
Nickel Plating Solution	-	2	-	2	X	1	-	-	-	1	1	-	-

\*\*Nitrile 150°F or less, no constant contact.

Rating Scale: 1 Excellent 2 Good resistance X Not recommended - Testing recommended [ ] Cover stock rating only; Rating for tube stock "X" * Use Gates fuel hose or contact Denver Product Application Department	Gates Hose Polymers							Couplings & Adapters					
	Polychloroprene Nitrile, HNBR, or XTF	Nitrile + PVC	CPE	CSM	Urethane	PTFE	Nylon	MegaTuff	Carbon Steel	Stainless Steel 304	Stainless Steel 316	Aluminum	Brass
Nickel Salts	2	-	1	-	-	-	1	-	-	-	-	-	-
Nicotine Salts	-	-	-	-	-	-	1	1	-	-	1	X	2
Nitric Acid	X	X	X	-	-	-	1	-	-	-	X	1	1
Nitric Acid, 3 Molar	X	X	-	-	-	-	1	-	1	-	X	1	1
Nitric Acid, Concentrated (Boiling)	X	X	-	-	-	-	1	X	X	X	2	2	
Nitric Acid, Inhibited Red Fuming (IRFNA)	X	X	-	-	-	-	1	-	X	X	1	1	
Nitric Acid, Red Fuming (RNFA)	X	X	X	-	X	X	1	X	X	X	2	2	
Nitric Acid, 5% To 10%	X	X	X	1	2	X	1	X	1	X	2	2	
Nitric Acid, 20%	X	X	X	1	2	X	1	X	1	X	2	2	
Nitric Acid, 50% (Boiling)	X	X	X	X	X	X	1	X	X	X	2	2	
Nitric Acid, 65% (Boiling)	X	X	X	X	X	X	1	X	X	X	2	2	
Nitric Acid & Hydrochloric Acid	-	X	-	-	-	-	1	-	X	X	X	X	
Nitrobenzene (Under 100°F)	X	X	X	2	X	X	1	2	-	-	1	1	
Nitroethane	X	X	X	1	2	-	1	-	-	-	1	1	
Nitrogen	1	1	2	1	1	1	1	1	X	1	1	1	
Nitrogen Oxide Up To 50% (Under 100°F)	1	1	2	1	1	-	1	1	-	-	1	1	
Nitromethane	X	X	X	-	-	-	1	1	-	-	1	1	
Nitropropane	X	X	X	-	-	-	1	1	-	-	1	1	
Nyvac 20 (WG), 30 (WG)	-	1	-	-	-	-	1	-	-	-	1	1	
Nyvac FR Fluid	-	1	-	-	-	-	1	-	-	-	1	1	
Nyvac FR200 Fluid	-	1	-	-	-	-	1	-	-	-	1	1	
N-Octane	X	2	-	1	X	-	-	-	-	-	1	1	
<b>O</b>													
Octyl Alcohol	2	2	2	1	-	-	1	1	-	-	1	1	
Oils, Crude	X	2	-	-	-	-	1	-	-	-	1	-	
Oil (SAE, Under 100°F)	1	1	1	1	2	1	1	1	-	-	1	1	
Oleic Acid (Under 120°F)	2	2	2	1	2	1	1	-	2	2	2	1	
Oleum	X	X	X	X	X	-	1	X	X	-	-	1	
Olive Oil	X	2	2	2	X	-	1	-	1	-	2	1	
OS 45 Type III (OS45)	1	2	-	-	-	-	1	-	-	-	-	-	
OS 45 Type IV (OS45-1)	1	2	-	-	-	-	1	-	-	-	-	-	
OS 70	1	2	-	-	-	-	1	-	-	-	-	-	
Oxalic Acid (5%, Hot And Cold)	2	2	-	-	-	-	1	2	-	X	2		
Oxalic Acid (10%)	2	2	-	-	-	-	1	2	1	X	2		
Oxalic Acid (10% Boiling)	X	X	-	-	-	-	1	-	-	X	X		
Oxalic Acid	X	X	X	1	2	X	1	X	-	-	X	2	
Oxygen, Gaseous	-	-	-	-	-	-	1	-	-	-	1	1	
Ozone (Dry)	2	X	2	1	2	1	1	2	2	1	1	1	
Ozone (Wet)	-	X	-	-	-	-	1	-	2	X	2		
<b>P</b>													
Paint	X	-	-	-	X	X	1	2	1	-	-	1	
Paint Solvents (Oil Base)	X	X	-	-	X	X	1	2	-	-	-	1	
Paints (Oil Base)	-	1	-	-	1	-	1	1	-	-	-	-	
Paint Thinner, Duco	2	1	-	-	-	-	1	1	-	2	2		
Palmetic Acid	2	2	2	1	X	1	1	1	1	2	2		
Palm Oil	2	1	2	-	2	-	1	-	-	1	1		
Paraffin (Petroleum)	2	1	2	1	X	-	1	1	1	2	1		
Paraformaldehyde	2	2	2	-	2	1	-	-	-	1	1		
Peanut Oil (Less Than 100°F)	2	1	2	-	-	-	1	-	-	1	1		
Pentamol	2	2	2	-	2	-	1	1	2	1	1		
Perchloric Acid	X	X	-	-	2	X	1	X	1	X	2		
Perchloroethylene (Tetrachloroethylene)	X	X	X	2	X	-	1	2	1	-	1	1	
Petroleum Ether	X	2	-	-	-	-	1	-	-	-	2		
Petroleum Oil (Crude)	2	1	-	-	-	-	1	-	1	-	-		
Petroleum Oil (Below 250°F)	2	1	-	-	-	-	1	-	X	-	-		

EQUIPMENT
HOSE/CPLG. SELECTION
G8K COUPLINGS
GLOBAL SPIRAL COUPLINGS
STAINLESS STEEL SPIRAL
MEGACRIMP COUPLINGS
STAINLESS STEEL BRAID
POWER CRIMP COUPLINGS
FIELD ATTACHABLE G1 & G2 COUPLINGS
FIELD ATTACHABLE C5 COUPLINGS
C14 COUPLINGS
GL COUPLINGS
GLX COUPLINGS
PCTS THERMOPLASTIC COUPLINGS
POLARSEAL COUPLINGS (ACA)
POLARSEAL II COUPLINGS (ACC)
POLARSEAL II COUPLINGS (ACB)
POWER STEERING
ADAPTERS
QUICK DISCONNECT COUPLERS
BALL VALVES
LIVE SWIVEL
ASSEMBLY FABRICATION
ACCESSORIES
EQUIPMENT AND PARTS
KITS
AIR BRAKE HOSE ASSY
BRASS

# CHEMICAL RESISTANCE TABLE – CONTINUED



EQUIPMENT
<b>HOSE/CPLG. SELECTION</b>
G8K COUPLINGS
GLOBAL SPIRAL COUPLINGS
STAINLESS STEEL SPIRAL
MEGACRIMP COUPLINGS
STAINLESS STEEL BRAID
POWER CRIMP COUPLINGS
FIELD ATTACHABLE G1 & G2 COUPLINGS
FIELD ATTACHABLE C5 COUPLINGS
C14 COUPLINGS
GL COUPLINGS
GLX COUPLINGS
PCTS THERMOPLASTIC COUPLINGS
POLARSEAL COUPLINGS (ACA)
POLARSEAL II COUPLINGS (ACC)
POLARSEAL II COUPLINGS (ACB)
POWER STEERING
ADAPTERS
QUICK DISCONNECT COUPLERS
BALL VALVES
LIVE SWIVEL
ASSEMBLY FABRICATION
ACCESSORIES
EQUIPMENT AND PARTS
KITS
AIR BRAKE HOSE ASSY
BRASS

Rating Scale: 1 Excellent 2 Good resistance X Not recommended - Testing recommended [ ] Cover stock rating only; Rating for tube stock "X" * Use Gates fuel hose or contact Denver Product Application Department	Gates Hose Polymers						Couplings & Adapters							
	Polychloroprene Nitrile, HNBR, or XTF	Nitrile + PVC	CPE	CSM	Urethane	PTFE	Nylon	MegaTuff	Carbon Steel	Stainless Steel 304	Stainless Steel 316	Aluminum	Brass	
Chemical Name														
Petroleum Oil (Above 250°F)	X	X	-	-	-	1	-	X	-	-	-	-	-	
Petroleum Oils (Under 100°F)	2	1	2	-	2	2	1	-	1	1	1	1	1	
Petroleum Oils (Refined)	2	1	2	-	2	2	1	1	1	1	1	1	1	
Petroleum Oils (Sour)	2	2	-	-	X	2	1	-	1	1	1	1	X	
Phenol (Carbolic Acid)	X	X	X	1	X	X	1	X	-	2	1	1	1	X
Phenol (70/30 Water)	X	X	-	-	-	1	-	-	-	1	1	1	-	
Phenol (85/15 Water)	X	X	-	-	-	1	-	-	-	1	1	1	-	
Phorone (Diisopropylidene Acetone)	X	X	-	-	X	X	1	-	-	1	1	1	-	1
Phosphate Esters (Concentrated)	X	X	-	X	X	X	1	2	1	-	-	-	-	-
Phosphate Esters (3 Molar)	X	X	-	2	2	X	1	2	1	-	-	-	-	-
Phosphate Esters (Dilute)	X	X	-	1	1	X	1	2	1	-	-	-	-	-
Phosphoric Acid	2	2	-	-	-	1	-	1	-	-	2	-	-	-
Phosphoric Acid (3 Molar)	X	X	-	-	-	1	-	1	-	-	-	-	-	-
Phosphoric Acid (Concentrated)	X	X	-	-	-	1	-	2	-	-	-	-	-	-
Phosphoric Acid (1%)	2	-	-	-	-	1	-	1	-	-	1	1	-	X
Phosphoric Acid (5%)	2	X	-	-	-	1	-	1	-	-	1	1	-	X
Phosphoric Acid (10%)	2	X	-	-	-	1	-	1	-	X	-	1	X	X
Phosphoric Acid (10% Hot)	2	X	-	-	-	1	-	-	X	-	1	X	X	X
Phosphoric Acid (50%)	2	2	2	1	1	X	1	X	1	X	2	1	X	2
Phosphoric Acid (50% Hot)	2	X	-	-	-	1	-	-	X	X	2	X	X	X
Phosphoric Acid (85%)	2	X	-	1	1	X	1	X	1	X	2	X	X	X
Phosphoric Acid (85% Hot)	2	X	-	-	-	1	-	-	X	X	X	X	X	X
Phosphoric Acid (Aerated)	-	-	-	-	-	1	-	-	X	-	2	-	-	-
Phosphoric Acid Air Free	-	-	-	-	-	1	-	1	X	-	-	X	-	-
Photographic Developers	1	1	-	-	-	1	-	-	X	1	1	-	-	-
Photographic, Emulsions	-	-	-	-	-	1	-	-	-	-	-	-	-	-
Photographic, Fixing Solutions	2	-	-	-	2	-	1	-	-	1	1	-	-	-
Phthalic Acid	-	-	-	-	-	-	-	-	2	2	1	2	-	-
Picric Acid (Water Solution 100°F)	2	2	2	-	2	-	1	X	2	X	1	1	X	X
Pinene	X	2	-	2	-	-	1	-	-	1	1	1	1	1
Pine Oil	X	2	-	2	X	-	1	1	-	1	1	1	1	-
Piperazine Hydrochloride Solution (34%)	-	2	-	-	-	-	1	-	-	-	-	-	-	-
Pitch	2	1	-	-	2	2	1	1	X	-	-	-	-	-
Plating Solutions (Chrome)	X	X	-	-	-	X	1	X	-	-	X	X	-	-
Plating Solutions (Other)	-	1	-	-	-	-	1	-	-	-	-	-	-	-
Polyester Resin	-	-	-	-	-	-	-	2	-	-	-	-	-	-
Polyurethane Foam (Under 125°F)	-	-	-	-	-	1	-	-	-	-	-	-	-	-
Potassium Acetate	2	2	-	1	2	X	1	-	-	2	1	1	X	-
Potassium Bicarbonate	1	1	-	-	1	-	1	1	-	1	2	2	1	-
Potassium Bisulfite	-	1	-	-	-	-	1	1	-	-	-	-	-	-
Potassium Bromate	-	-	-	-	-	1	-	1	-	-	-	-	-	-
Potassium Bromide	1	1	-	-	1	2	1	1	-	X	X	2	X	-
Potassium Carbonate (Potash)	1	1	1	1	1	2	1	1	-	2	1	1	X	X
Potassium Chlorate	1	1	-	-	-	2	1	1	-	2	2	2	-	-
Potassium Chloride (1% To 5%)	1	1	-	1	-	2	1	1	1	1	2	2	X	X
Potassium Chloride (Boiling)	-	-	-	-	-	1	-	X	-	-	2	2	-	X
Potassium Cyanide	1	1	-	1	-	-	1	1	-	2	1	1	X	X
Potassium Dichromate	1	1	-	1	-	-	1	2	-	1	2	2	2	-
Potassium Ferrocyanide	-	-	-	-	-	1	-	-	-	2	1	1	2	-
Potassium Fluoride	-	-	-	-	-	1	-	-	-	-	-	-	-	-
Potassium Hydroxide	2	2	-	-	-	1	-	-	-	1	1	1	-	-
Potassium Hydroxide (5%)	1	1	-	-	-	1	1	1	-	2	2	2	X	X
Potassium Hydroxide (27% Boiling)	-	-	-	-	-	1	-	X	2	2	1	X	X	-

\*\*Nitrile 150°F or less, no constant contact.

Rating Scale: 1 Excellent 2 Good resistance X Not recommended - Testing recommended [ ] Cover stock rating only; Rating for tube stock "X" * Use Gates fuel hose or contact Denver Product Application Department	Gates Hose Polymers						Couplings & Adapters							
	Polychloroprene Nitrile, HNBR, or XTF	Nitrile + PVC	CPE	CSM	Urethane	PTFE	Nylon	MegaTuff	Carbon Steel	Stainless Steel 304	Stainless Steel 316	Aluminum	Brass	
Chemical Name														
Potassium Hydroxide (30%, Caustic Potash)	-	-	-	1	-	-	1	-	-	-	-	-	-	
Potassium Hydroxide (50% Boiling)	-	-	-	-	-	-	1	-	X	2	2	2	X	X
Potassium Hydroxide (70%) Potassium Hydroxide (70% Hot)	-	1	-	-	-	-	1	-	-	-	-	-	X	X
Potassium Iodide	1	1	-	-	1	-	1	1	1	1	2	2	-	-
Potassium Nitrate	1	1	-	1	-	1	1	1	-	1	1	2	2	2
Potassium Nitrate (1% To 5%)	1	1	-	-	-	1	-	-	-	1	1	1	1	2
Potassium Permanganate	1	2	-	-	-	-	1	2	-	1	2	2	2	-
Potassium Permanganate (5%)	1	1	-	-	-	-	1	1	-	1	1	1	1	-
Potassium Persulfate	-	-	-	-	-	1	-	-	-	-	-	-	-	-
Potassium Phosphate	1	-	-	-	1	-	1	-	-	X	2	2	X	-
Potassium Sulfate	1	1	-	1	-	1	1	1	-	1	2	2	1	-
Potassium Sulfate - 1% & 5%	1	1	-	-	-	1	1	1	1	1	1	1	1	X
Potassium Sulfide	1	1	-	-	-	1	-	-	-	2	2	2	-	-
Potassium Sulfite	1	1	-	1	-	1	-	1	-	1	1	1	1	-
Potassium Thiosulfate	1	-	-	1	-	1	-	-	-	-	-	-	-	-
Primatol A, S, P (Ag Spray)	-	-	-	-	-	1	-	-	-	-	-	-	-	-
Propane Gas	X	X	-	-	-	X	1	-	X	1	1	1	-	1
Propionic Acid	X	X	-	-	-	1	-	1	-	1	1	2	2	-
Propyl Acetate	X	X	-	2	-	-	1	-	-	1	-	-	-	-
Propyl Alcohol	1	1	2	1	-	X	1	1	1	1	1	1	-	2
Propylene (Liquid Or Gas, Ambient)	X	X	-	1	-	-	1	2	-	1	1	1	1	-
Propylene Dichloride	-	-	-	-	-	1	-	-	-	1	2	1	X	-
Propylene Glycol	1	1	-	1	1	1	1	2	1	1	1	1	-	-
Propylene Oxide	X	X	-	-	-	-	-	-	-	2	1	1	2	-
Purina Insecticide	X	X	-	-	-	-	1	2	-	1	1	1	1	2
Puropale RX Oils	-	1	-	-	-	2	1	1	-	1	1	1	1	1
Pyranol, Transformer Oil	2	1	-	-	-	-	1	-	-	1	1	1	1	-
Pydraul	X	X	-	-	-	-	1	-	-	-	-	-	-	-
Pydraul 10E, 29E-LT, 30E, 60, 65E, 115E	X	X	-	2	-	-	1	-	-	1	1	1	1	1
Pydraul 135	-	X	-	2	-	-	1	2	-	1	1	1	-	-
Pydraul 150	X	X	X	2	X	2	1	2	-	1	1	1	1	1
Pydraul 280	X	X	X	2	X	2	1	2	-	1	1	1	-	-
Pydraul 312	X	X	X	2	-	2	1	1	-	1	1	1	-	-
Pydraul 50E	-	-	-	2	-	2	1	1	-	1	1	1	-	-
Pydraul 540	X	X	X	2	X	X	1	X	-	1	1	1	-	-
Pydraul 625	X	X	X	2	X	2	1	2	-	1	1	1	-	-
Pydraul A-200	X	X	X	2	X	X	1	2	-	1	1	1	-	-
Pydraul F-9	X	X	X	2	X	2	1	1	-	1	1	1	-	-
Pyridine (50%)	X	X	-	-	X	1	1	-	-	1	1	1	1	1
Pyrogard 160, 230, 630	-	-	-	-	-	1	-	-	-	1	1	1	-	-
Pyrogard 51, 53, 55	-	X	-	-	-	1	-	-	-	1	1	1	-	-
Pyrogard C, D	-	1	-	-	-	2	1	1	-	1	1	1	1	1
<b>Q</b>														
Quench Oil	2	2	-	-	-	1	-	-	-	-	1	1	1	-
Quintolubric 822	2	1	-	-	-	1	-	-	-	1	1	1	1	1
<b>R</b>														
Ramrod (Ag Spray)	-	-	-	-	-	1	1	-	-	1	1	1	1	1
Rando Oils	-	1	-	-	-	2	1	1	-	1	1	1	1	1
Rape Seed Oil	2	X	-	-	X	-	1	2	1	1	1	1	1	1
Red Oil (Comm. Oleic Acid, MIL-H-5606)	2	2	2	1	2	-	1	1	2	2	2	1	1	2
Refined Wax (Petroleum)	2	1	2	-	-	2	1	1	-	1	1	1	-	1
Regal Oils R&O	-	1	-	-	-	2	1	1	-	1	1	1	1	1
Richfield Weed Killer	X	2	-	-	X	-	1	-	-	-	-	-	-	-





CHEMICAL RESISTANCE TABLE - CONTINUED

Table with columns: Rating Scale (1-2, X, -), Gates Hose Polymers (Nitrile, CPE, etc.), Couplings & Adapters (Carbon Steel, etc.), Chemical Name, and a grid of resistance ratings.

\*\*Nitrile 150°F or less, no constant contact.

Table with columns: Rating Scale (1-2, X, -), Gates Hose Polymers (Nitrile, CPE, etc.), Couplings & Adapters (Carbon Steel, etc.), Chemical Name, and a grid of resistance ratings.

Table listing equipment types: HOSE/CPLG. SELECTION, G8K COUPLINGS, GLOBAL SPIRAL COUPLINGS, STAINLESS STEEL SPIRAL, MEGACRIMP COUPLINGS, STAINLESS STEEL BRAID, POWER CRIMP COUPLINGS, FIELD ATTACHABLE G1 & G2 COUPLINGS, FIELD ATTACHABLE C5 COUPLINGS, C14 COUPLINGS, GL COUPLINGS, GLX COUPLINGS, PCTS THERMOPLASTIC COUPLINGS, POLARSEAL COUPLINGS (ACA), POLARSEAL II COUPLINGS (ACC), POLARSEAL II COUPLINGS (ACB), POWER STEERING, ADAPTERS, QUICK DISCONNECT COUPLERS, BALL VALVES, LIVE SWIVEL, ASSEMBLY FABRICATION, ACCESSORIES, EQUIPMENT AND PARTS, KITS, AIR BRAKE HOSE ASSY, BRASS.



CHEMICAL RESISTANCE TABLE – CONTINUED



EQUIPMENT
<b>HOSE/CPLG. SELECTION</b>
G8K COUPLINGS
GLOBAL SPIRAL COUPLINGS
STAINLESS STEEL SPIRAL
MEGACRIMP COUPLINGS
STAINLESS STEEL BRAID
POWER CRIMP COUPLINGS
FIELD ATTACHABLE G1 & G2 COUPLINGS
FIELD ATTACHABLE C5 COUPLINGS
C14 COUPLINGS
GL COUPLINGS
GLX COUPLINGS
PCTS THERMOPLASTIC COUPLINGS
POLARSEAL COUPLINGS (ACA)
POLARSEAL II COUPLINGS (ACC)
POLARSEAL II COUPLINGS (ACB)
POWER STEERING
ADAPTERS
QUICK DISCONNECT COUPLERS
BALL VALVES
LIVE SWIVEL
ASSEMBLY FABRICATION
ACCESSORIES
EQUIPMENT AND PARTS
KITS
AIR BRAKE HOSE ASSY
BRASS

Rating Scale: 1 Excellent 2 Good resistance X Not recommended - Testing recommended [ ] Cover stock rating only; Rating for tube stock "X"	Gates Hose Polymers	Couplings & Adapters
Chemical Name	Polychloroprene Nitrile, HNBR, or XTF Nitrile + PVC CPE CSM Urethane PTFE Nylon MegaTuff	Carbon Steel Stainless Steel 304 Stainless Steel 316 Aluminum Brass
Sulfuric Acid, Aerated, No Velocity	- - - - - 1 - 1	2 2 2 X -
Sulfuric Acid, Air Free No Velocity	- - - - - 1 - 1	X X 2 X -
Sulfuric Acid, Concentrated	X X - - - 1 - 1	- 1 1 - -
Sulfuric Acid, Fuming, Oleum	X - - - - 1 - 1	2 1 1 2 -
Sulfuric Acid (10%)	1 2 2 1 1 - 1 X X	- X X 2 X
Sulfuric Acid (30%)	1 - - 1 1 - 1 X 1	X X 2 X X
Sulfuric Acid (50%)	2 X X 1 1 - 1 X 1	X X 2 X X
Sulfuric Acid (75%)	X X X - 2 - 1 X 1	X X 2 X X
Sulfuric Acid (93%)	X X X - X - 1 X 1	2 X 2 X X
Sulfuric Acid (98%)	X X X X X - 1 X 1	2 X 2 X X
Sulfurous Acid	2 2 - - - 1 X 1	X X 2 2 -
Sulfurous Acid (10%)	- X - 1 1 - 1 - 1	- X 2 1 X
Sulfurous Acid (75%)	X X X 1 1 - 1 X 1	X X 2 X X
Sun R&O Oils	- 1 - - - 2 1 1 -	1 1 1 1 1
Sunsafe (Fire Resist. Hydr. Fluid)	2 1 - - - 2 1 1 -	1 1 1 1 -
Suntac HPOils	- 1 - - - 2 1 1 -	1 - 1 1 -
Suntac WR Oils	- 1 - - - 2 1 1 -	1 - 1 1 -
Sunvis Oils 700, 800, 900	- 1 - - - 2 1 1 -	1 1 1 - -
Super Hydraulic Oils (Conoco)	- 1 - - - 2 1 1 -	1 1 1 1 -
Sutan Plus, Herbicide	X X X 1 - - - 1 -	1 1 1 1 -
Sutazine Plus, Herbicide	X X - 1 - - - 1 -	X 1 1 1 -
Synthetic Oil (Citgo)	- - - - - 2 - 1 -	1 1 1 - -
Syrup	2 1 2 - - - 1 1 -	- 1 1 1 1 -
<b>T</b>		
Tall Oil (Under 150°F)	2 2 2 - X - 1 - -	2 X 2 X -
Tallow	2 2 2 - - - 1 1 -	2 2 2 1 2
Tannic Acid (10%)	2 X - 1 2 - 1 X 1	2 1 1 2 X
Tar And Tar Oil	2 - - - - 2 1 1 -	1 1 1 1 2
Tar (Bituminous, Under 100°F)	2 2 2 X - 1 - 1 -	1 1 1 1 2
Tartaric Acid	2 2 2 1 1 - 1 1 1	X 2 2 2 X
Tellus Oils	- 1 - - - 2 1 1 -	1 1 1 1 1
Tenol Oils	- 1 - - - 2 1 1 -	1 1 1 - -
Tergitol	- - - - - 1 - -	2 1 1 - 2
Terpineol	X 2 - 1 2 - 1 2 -	- - - - -
Terresstic	- 1 - - - - 1 -	1 1 1 - -
Tetraethyl Lead	2 2 - - - 1 2 -	- - - - -
Tetraethyl Lead Blend	X 2 - - - - 1 - -	- - - - -
Tetrahydrofuran (THF)	X X - - X 2 1 1 -	2 - - - -
Tetralin	X X - - X - 1 2 -	1 1 1 1 -
Thiopen	X X - - - - 1 - -	- - - - -
Titanium Tetrachloride	X X X - - - 1 - -	1 2 2 X X
Toluene (Toluol)	X X X X X - 1 1 2	1 1 1 1 1
Toluene Diisocyanate (Under 150°F)	X - - - - 1 - 1	1 1 1 - -
Transformer Oil (Askarel Types)	X X X 1 X - 1 - 2	1 1 1 1 -
Transformer Oil (Petroleum Type)	2 1 2 1 X 2 1 1 -	1 1 1 1 1
Transmission Fluid, Type A	2 1 2 1 2 - 1 2 -	1 1 1 1 1
Tributoxyethyl Phosphate	X X X X X - 1 2 X	1 - - X -
Tributyl Phosphate	X X X 2 X - 1 - X	1 - - X -
Trichloroethylene	X X X 2 X - 1 2 X	X 2 1 X 1
Trichloromonofluoroethane (Freon 17)	Use Freon Hose	1 1 1 X -
Trichlorotrifluoroethane (Freon 113)	Use Freon Hose	1 1 1 X -
Tricresyl Phosphate	X X X 1 X - 1 1 X	1 2 2 X -

\*\*Nitrile 150°F or less, no constant contact.

Rating Scale: 1 Excellent 2 Good resistance X Not recommended - Testing recommended [ ] Cover stock rating only; Rating for tube stock "X"	Gates Hose Polymers	Couplings & Adapters
Chemical Name	Polychloroprene Nitrile, HNBR, or XTF Nitrile + PVC CPE CSM Urethane PTFE Nylon MegaTuff	Carbon Steel Stainless Steel 304 Stainless Steel 316 Aluminum Brass
Triethanolamine (TEA)	2 2 - 1 2 - 1 1 -	1 1 1 1 1
Tripolyphosphate (STPP)	X 1 - - - - 1 - -	- 2 1 X -
Tung Oil	2 2 - - 2 - 1 1 -	1 1 1 1 1
Turpentine	X 2 - 2 X 1 1 1 1	X 1 1 1 2
Type I Fuel (MIL-S-3136) ASTM Fuel A	2 1 - - - - 1 - -	1 1 1 1 -
Type II Fuel (MIL-S-3136)	X 2 - - - - 1 - -	1 1 1 1 -
Type III Fuel (MIL-3136) ASTM Fuel B	X 1 - - - - 1 - -	1 1 1 1 -
<b>U</b>		
Ucon Hydrolube Types 150CP, 200CP	- 1 - - - 2 1 1 -	1 1 1 1 1
Ucon Hydrolube Types 275CP, 300CP, 550CP	- - - - - 1 - -	- - - - -
Ucon M1	- 1 - - - 2 1 1 -	1 1 1 1 1
Union ATF Dexron	- 1 - - - 2 1 1 -	1 1 1 - -
Union ATF Type F	- 1 - - - 2 1 1 -	1 1 1 1 1
Union C-2 Fluid	- 1 - - - 2 1 1 -	1 1 1 - -
Union C-POil	- 1 - - - 2 1 1 -	1 1 1 1 1
Union Hydraulic Oil AW	- 1 - - - 2 1 1 -	1 1 1 1 1
Union Hydraulic Tractor Fluid	- 1 - - - 2 1 1 -	1 1 1 1 1
Urea Solution	1 2 - 1 1 2 1 1 1	1 1 1 2 -
<b>V</b>		
Varnish	X X X - X - 1 1 -	2 1 1 1 2
Vegetable Oils	2 1 2 1 - 2 1 1 1	1 1 1 1 2
Vegetable Oil (Hot)	- - - - - 1 1 -	2 2 2 1 2
Versilube	1 1 - - - - 1 - -	1 1 1 1 -
Versilube F-50, F-44	2 2 2 - 2 2 1 1 -	1 1 1 1 1
Vinegar	2 X X 2 X - 1 1 X	X 2 1 X X
Vinyl Acetate	X X X 1 X - 1 - X	2 1 2 1 2
Vinyl Chloride (Chloroethylene, Monomer)	X X X X X - 1 - -	2 1 1 2 X
Vitrea Oils	X X X - - 2 1 1 -	1 1 1 - -
<b>W</b>		
Water	1 1 1 1 1 1 1 1 1	2 1 1 1 1
Water, Acid Mine	2 X - - - - 1 1 -	X 2 2 X X
Water, Brine	2 2 - - - 1 1 1 1 -	X 2 2 - -
Water Deionized, (Deminerlized)	- - - - - 1 - 1 -	- - - - -
Water, Distilled	2 1 - - - 1 1 1 1 1	X 1 1 1 1
Water, Fresh	1 1 - - - - 1 1 1	X 1 1 1 X
Water In Oil Emulsions	- - - - - 2 1 1 -	- - - - -
Water, Potable (FDA Tube Only)	Use FDAHose Only	- - - - -
Water, Salt	2 1 - - - - 1 1 -	X 2 2 X X
White & Bagley No. 2190 Cutting Oil	2 1 - - - - 1 - -	- - - - -
Wines	2 1 1 1 1 - 1 1 -	2 2 2 1 -
Wood Oil	2 1 - 1 2 1 1 1 -	1 1 1 1 -
<b>X</b>		
Xylene	X 1 - X - 2 1 X 2	2 2 2 - -
<b>Z</b>		
Zeric	- 1 - - - 2 1 2 1	- - - - -
Zinc Acetate	2 X - - X - 1 2 1	1 1 1 1 1
Zinc Chloride Solutions	1 1 1 1 1 - 1 1 1	X 2 1 X X
Zinc Chromate	- - - 1 1 - 1 - 1	- 1 1 - -
Zinc Hydrate	- - - - - 2 1 - -	- - - - -
Zinc Sulfate Solutions	2 2 2 1 2 - 1 2 1	X 2 1 X X



# FLOW CAPACITY OF HOSE ASSEMBLIES AT RECOMMENDED FLOW VELOCITIES

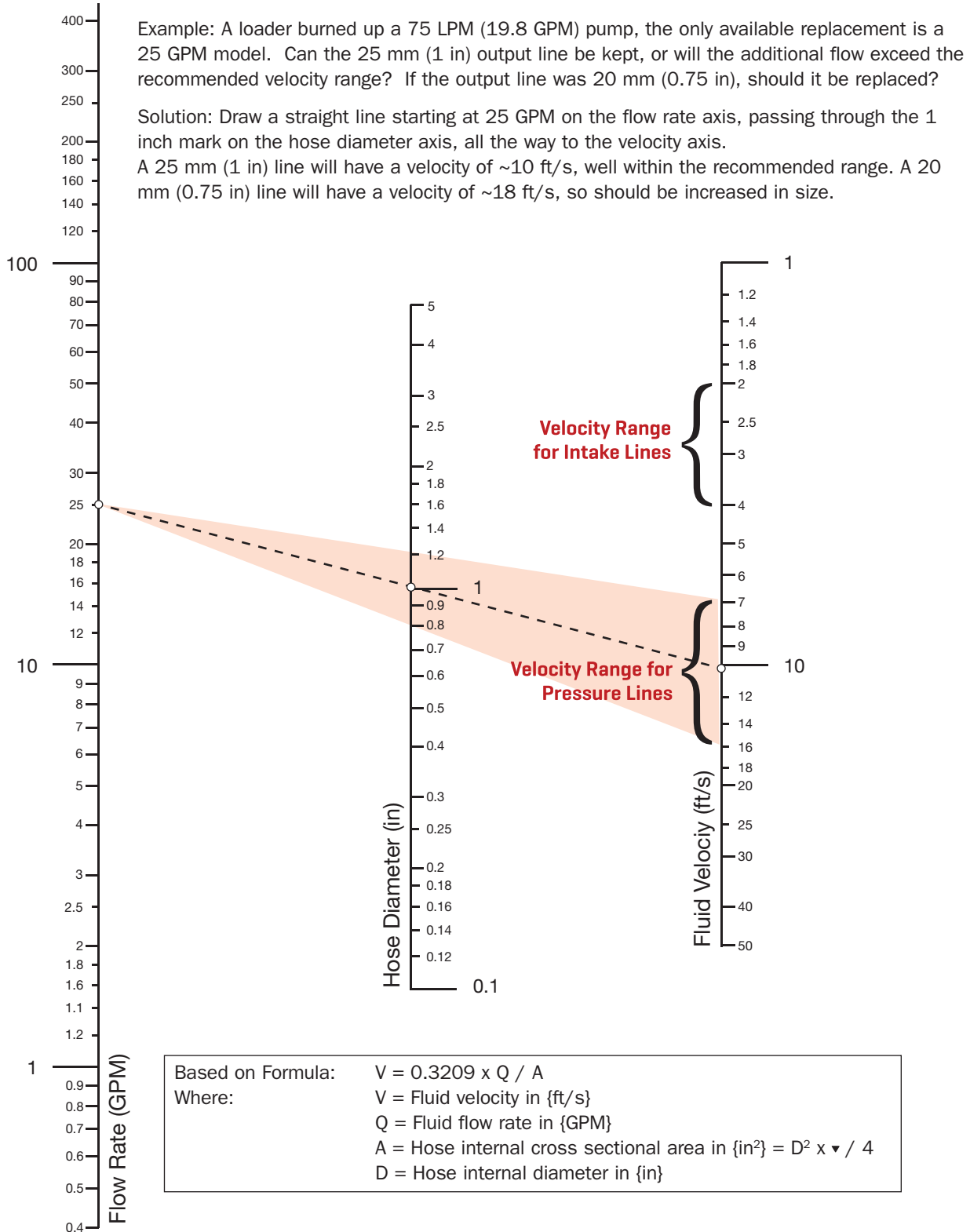

EQUIPMENT
HOSE/CPLG. SELECTION
G8K COUPLINGS
GLOBALSPIRAL COUPLINGS
STAINLESS STEEL SPIRAL
MEGACRIMP COUPLINGS
STAINLESS STEEL BRAID
POWER CRIMP COUPLINGS
FIELD ATTACHABLE G1 & G2 COUPLINGS
FIELD ATTACHABLE C5 COUPLINGS
C14 COUPLINGS
GL COUPLINGS
GLX COUPLINGS
PCTS THERMOPLASTIC COUPLINGS
POLARSEAL COUPLINGS (ACA)
POLARSEAL II COUPLINGS (ACC)
POLARSEAL II COUPLINGS (ACB)
POWER STEERING
ADAPTERS
QUICK DISCONNECT COUPLERS
BALL VALVES
LIVE SWIVEL
ASSEMBLY FABRICATION
ACCESSORIES
EQUIPMENT AND PARTS
KITS
AIR BRAKE HOSE ASSY
BRASS

PROPERTIES OF C14 PTFE TUBE



EQUIPMENT
<b>HOSE/CPLG. SELECTION</b>
G8K COUPLINGS
GLOBAL SPIRAL COUPLINGS
STAINLESS STEEL SPIRAL
MEGACRIMP COUPLINGS
STAINLESS STEEL BRAID
POWER CRIMP COUPLINGS
FIELD ATTACHABLE G1 & G2 COUPLINGS
FIELD ATTACHABLE C5 COUPLINGS
C14 COUPLINGS
GL COUPLINGS
GLX COUPLINGS
PCTS THERMOPLASTIC COUPLINGS
POLARSEAL COUPLINGS (ACA)
POLARSEAL II COUPLINGS (ACC)
POLARSEAL II COUPLINGS (ACB)
POWER STEERING
ADAPTERS
QUICK DISCONNECT COUPLERS
BALL VALVES
LIVE SWIVEL
ASSEMBLY FABRICATION
ACCESSORIES
EQUIPMENT AND PARTS
KITS
AIR BRAKE HOSE ASSY
BRASS

Tensile Strength, 73°F (23°C)	1500-3000 psi
Elongation, 73°F (23°C)	100-200%
Stiffness, 73°F (23°C)	60,000 psi
Impact Strength @70°F (21°C)	2.0 lbf-ft/in
@73°F (23°C)	3.5 lbf-ft/in
@170°F (77°C)	6.0 lbf-ft/in
Hardness, Durometer	D55-D70 Shore D
Compressive Stress at	
1% Deformation @73°F (23°C)	600 psi
1% Offset @73°F (23°C)	1000 psi
Deformation Under Load, 24 Hrs. @ 122°F (50°C)	
1200 Lb./Sq. In.	4-8%
2000 Lb./Sq. In.	25%
Heat-Distortion Temperature @66 Lb./Sq. In.	250°F (121°C)
Coefficient of Linear Thermal Expansion per °F; 77-140°F (25-60°C)	5.5 x 10 <sup>-5</sup>
Thermal Conductivity 0.18 In.	1.7 BTU/hr/sq ft/°F/in
Specific Heat	0.25 BTU/lb/°F
Water Absorption	0.0%
Flammability	Nonflammable
Specific Gravity	2.1-2.3



Most applications of PTFE hose do not require the use of a conductive inner tube. Under certain applications, the potential for Static Discharge must be considered. Be aware that static electricity can be a hazard. Under those conditions where static discharge can occur, the use of conductive Gates C14CT hose is recommended. The following should serve to increase your knowledge and understanding of this phenomenon and how to avoid its occurrence:

When two different materials contact each other, electrons from one material can move across its boundary and associate with the other. These electrons align themselves with the material contacted. If the two materials are good conductors of electricity, the positive and negative electrons flow back and forth between them, keeping them in balance. If one or both are insulators, the flow will not occur. A charge will then build up on the surface of one of the materials. When the charge exceeds the electric strength of the material, electric breakdown results.

In applying this to PTFE hose, we have to consider fluids and gases that are poor conductors of electricity and the flow rates of those fluids and gases. In order for a liquid or gas to be a poor electrical conductor, it will generally satisfy one or both of the following conditions:

1. Be nonpolar; that is, an imbalance between protons and electrons, and/or
2. Contain a nonmixable component or a suspended solid; such as water in kerosene.

So when a liquid contacts a PTFE tube that isn't a good conductor (white PTFE innercore), the result is phase separation and the electric charge starts to build. The rate at which static electricity builds up now becomes a function of the fluid flow rate. When the electric strength of the PTFE tube is exceeded, the electric charge will puncture the tube wall and ground itself on the stainless steel braid of the hose.

In hydraulics, high pressures generally mean high velocities. Historically, fluids were filtered upstream of the hose using metallic filter elements. The metallic element helped to ground the charge. But, today, most filtration is done with paper-type and glass-fiber filter elements that have a tendency to inject an electrostatic charge into the fluid they are filtering.

**Steam and fuels are two specific areas of concern. No hose in this catalog can or should be used in steam applications. Contact Gates Product Application for proper hose recommendation.**

Fuels (i.e. gasoline and white spirits, hydrazine, benzene, diesel oils, etc.) are, for the most part, "nonconductive" liquids. These fluids usually are transferred at fairly low velocities, but there still is a potential for an electrostatic discharge due to external factors, such as humidity and, to some extent, temperature. You should take all of these factors into account even at fluid velocities at or below 1 meter per second.

When using PTFE hose, you can offset the potential hazard of electrostatic discharge by using a conductive Gates C14CT hose. Carbon is added to the PTFE inner tube wall during manufacture. The carbon layer directs the electrostatic charge down the inner diameter of the hose to the metal end fittings. This prevents the charge from building up on the inner tube wall.

So, it's important to examine any application where nonconductive fluids are used and any of the above conditions exist. This section is not meant to cover all conditions or situations when they involve fuels, steam or other media which may cause electrostatic buildup or potential discharge. If you need help on any individual application, contact Hose/Connector Product Application, Denver.

Following is a list of some of the chemicals that meet at least one of the criteria necessary to create electrostatic discharge:

- Cyclohexane
- Decalin
- Diacetone
- Dibutyl Ether
- Dibutyl Phthalate
- Dibutyl Sebacate
- Dimethyl Phthalate
- Dioctyl Phthalate
- Dipentene
- Fuel Oil
- Gasoline
- Hexane
- Hexene
- Hydrazine
- Kerosene
- Lacquers
- Lacquer Solvents
- Naphtha
- Naphthalene
- Octane
- Paint
- Petroleum
- Pinene
- Silicone Oils
- Skydrol 500 & 700
- Steam
- Toluene
- Transformer Oil
- Turpentine
- Varnish
- Versilube

**General Industry Practice has identified the above fluids as requiring a conductive hose—Gates C14CT.**

EQUIPMENT
HOSE/CPLG. SELECTION
G8K COUPLINGS
GLOBALSPIRAL COUPLINGS
STAINLESS STEEL SPIRAL
MEGACRIMP COUPLINGS
STAINLESS STEEL BRAID
POWER CRIMP COUPLINGS
FIELD ATTACHABLE G1 & G2 COUPLINGS
FIELD ATTACHABLE C5 COUPLINGS
C14 COUPLINGS
GL COUPLINGS
GLX COUPLINGS
PCTS THERMOPLASTIC COUPLINGS
POLARSEAL COUPLINGS (ACA)
POLARSEAL II COUPLINGS (ACC)
POLARSEAL II COUPLINGS (ACB)
POWER STEERING
ADAPTERS
QUICK DISCONNECT COUPLERS
BALL VALVES
LIVE SWIVEL
ASSEMBLY FABRICATION
ACCESSORIES
EQUIPMENT AND PARTS
KITS
AIR BRAKE HOSE ASSY
BRASS



EQUIPMENT
HOSE/CPLG. SELECTION
G8K COUPLINGS
GLOBAL SPIRAL COUPLINGS
STAINLESS STEEL SPIRAL
MEGACRIMP COUPLINGS
STAINLESS STEEL BRAID
POWER CRIMP COUPLINGS
FIELD ATTACHABLE G1 & G2 COUPLINGS
FIELD ATTACHABLE C5 COUPLINGS
C14 COUPLINGS
GL COUPLINGS
GLX COUPLINGS
PCTS THERMOPLASTIC COUPLINGS
POLARSEAL COUPLINGS (ACA)
POLARSEAL II COUPLINGS (ACC)
POLARSEAL II COUPLINGS (ACB)
POWER STEERING
ADAPTERS
QUICK DISCONNECT COUPLERS
BALL VALVES
LIVE SWIVEL
ASSEMBLY FABRICATION
ACCESSORIES
EQUIPMENT AND PARTS
KITS
AIR BRAKE HOSE ASSY
BRASS

**WHAT IS EFFUSION?**

It is the process where chemical molecules move through the PTFE wall and escape from a hose or hose assembly. It is sometimes called permeation. The rate at which effusion occurs depends upon temperature, pressure, wall thickness and the hose material.

The fact that effusion occurs isn't the problem. This process will happen with most all media in most hose material.

**The basic issues are:**

1. At what rate will effusion occur?
2. How hazardous are the media?
3. In what kind of environment does effusion take place; closed room, outside, etc.?

**GENERAL MEDIA CONCERNS REGARDING THE POTENTIAL EFFECTS OF EFFUSION:**

- Media where corrosion is not of concern, but effusion may displace the air we breathe, thus becoming a hazard to personnel.

Some of the chemicals in this category are:

- Carbon Dioxide
- Neon
- Nitrogen
- Argon
- Steam
- Xenon
- Oxygen
- Krypton
- Helium

- Media that can effuse in their "vapor phase"; i.e., their boiling point is below approximately +125°F (+52°C) at atmospheric pressure. These media can form chemicals that can corrode the braid and/or cause injury to personnel.

**Some of these include:**

- Acetaldehyde (Flammable, Toxic)
- Benzene (Flammable, Toxic)
- Liquid Butane (Flammable)
- Carbon Disulfide (Flammable, Toxic)
- Diethyl Ether (Flammable, Narcotic)
- Ethyl Mercaptan (Flammable, Toxic)
- Hydrochloric Acid (Corrosive, Toxic)
- Lacquer Solvents (Flammable)
- Methyl Bromide (Flammable, Toxic, Corrosive)

- Methylene Chloride (Toxic)
- Methyl Formate (Flammable, toxic)
- Liquid Propane (Flammable)
- Sulphur Trioxide (Corrosive, toxic)
- Liquid Chlorine (Corrosive, toxic)

- Media with the potential to effuse and cause corrosion of the braid reinforcement and fitting materials. These chemicals are all gases while at atmospheric pressure and a temperature of +56°F (+13°C) or lower.

**Some of these chemicals are:**

- Acetylene (Flammable)
- Butadiene (Flammable)
- Butane Gas (Flammable)
- Carbon Monoxide (Toxic, Flammable)
- Chlorine (Toxic, Corrosive)
- Chlorine Trifluoride (Toxic, Corrosive)
- Ethyl Chloride (Toxic, Corrosive)
- Hydrogen (Flammable)
- Hydrogen Chloride (Corrosive, Toxic)
- Hydrogen Sulfide (Flammable, Toxic)
- Hydrocyanic Acid (Flammable, Toxic)
- Hydrogen Cyanide (Flammable, Toxic)
- Coke Oven Gas (Flammable, Toxic)
- Natural Gas (Flammable, Toxic)
- Propane Gas (Flammable)
- Sulfur Dioxide (Corrosive)
- Vinyl Chloride Monomer (Toxic, Corrosive)

It is important that hose assemblies used in these applications are installed in well-vented areas to avoid potential problems for personnel and/or equipment.



**WHAT IS PRESSURE DROP?**

Friction is defined as the resistance an object encounters in moving over another. Solids, liquids, and gasses all exhibit friction in their motion. In hose and piping systems the result of this friction is pressure drop and heat generation that may be accurately estimated with engineering models.

**WHY DOES PRESSURE DROP MATTER?**

If there is excessive pressure drop in a system pumps, will have to work harder, use more energy, and the working fluid will increase in temperature. Depending on the source of the additional pressure loss it could: raise the whole system pressure, increasing wear and introducing potentially dangers over pressure conditions; render some tools or equipment functions inoperable, because of inadequate operation pressure; or create damaging cavitation and loss of net positive suction head (NPSH).

**WHAT AFFECTS PRESSURE DROP?**

The factors which contribute pressure loss may be broken down into two general categories: mechanical components and fluid properties. Mechanical components such as valves, flow meters, quick disconnects, adapters, couplings, tubing, hose, etc., all contribute to pressure loss. The amount of pressure loss in mechanical components is impacted by criteria such as cross sectional area, internal surface roughness, length, bends, and geometric complexity. Fluid properties such as density, viscosity, heat capacity and bulk modulus will also contribute to pressure loss. Fluid properties are impacted by temperature, pressure, contamination, air entrainment, and time.

While all of these components contribute to pressure loss, fluid velocity has the most impact. Fluid velocity is a direct product of flow rate and cross sectional area.

**WHAT CAN BE DONE TO REDUCE PRESSURE DROP?**

- Check system pressure drop when non-identical replacement parts are required or there is ongoing system problems.
- Use straight adapters and bent couplings whenever possible.
- Replace worn parts and old fluids.
- Lower the fluid velocity.

**HOW CAN I CALCULATE PRESSURE DROP FOR A HOSE ASSEMBLY?**

With some basic system information reliable pressure drop approximations may be readily calculated. First determine the applicable mechanical components and fluid for the analysis (doing 1 hose assembly at a time is recommended), then enter those values into the Gates online pressure drop calculator. Hose assembly information: Inside Diameter, Length, Couplings, Adapters

**Fluid information:** Density, Viscosity, and Heat Capacity (these may be estimated with fluid type and temperature)

**Go to <https://www.gates.com/resources/calculators/fluid-flow-pressure-calculator> to calculate the pressure loss from the system information.**

EQUIPMENT
HOSE/CPLG. SELECTION
G8K COUPLINGS
GLOBALSPIRAL COUPLINGS
STAINLESS STEEL SPIRAL
MEGACRIMP COUPLINGS
STAINLESS STEEL BRAID
POWER CRIMP COUPLINGS
FIELD ATTACHABLE G1 & G2 COUPLINGS
FIELD ATTACHABLE C5 COUPLINGS
C14 COUPLINGS
GL COUPLINGS
GLX COUPLINGS
PCTS THERMOPLASTIC COUPLINGS
POLARSEAL COUPLINGS (ACA)
POLARSEAL II COUPLINGS (ACC)
POLARSEAL II COUPLINGS (ACB)
POWER STEERING
ADAPTERS
QUICK DISCONNECT COUPLERS
BALL VALVES
LIVE SWIVEL
ASSEMBLY FABRICATION
ACCESSORIES
EQUIPMENT AND PARTS
KITS
AIR BRAKE HOSE ASSY
BRASS



# FAHRENHEIT-CELSIUS CONVERSION



Locate the temperature to be converted in the center column. This number can be in Celsius or Fahrenheit. The equivalent converted temperature for Centigrade/Celsius is listed in the left column and the equivalent converted temperature for Fahrenheit is located in the right column.

EQUIPMENT
HOSE/CPLG. SELECTION
G8K COUPLINGS
GLOBAL SPIRAL COUPLINGS
STAINLESS STEEL SPIRAL
MEGACRIMP COUPLINGS
STAINLESS STEEL BRAID
POWER CRIMP COUPLINGS
FIELD ATTACHABLE G1 & G2 COUPLINGS
FIELD ATTACHABLE C5 COUPLINGS
C14 COUPLINGS
GL COUPLINGS
GLX COUPLINGS
PCTS THERMOPLASTIC COUPLINGS
POLARSEAL COUPLINGS (ACA)
POLARSEAL II COUPLINGS (ACC)
POLARSEAL II COUPLINGS (ACB)
POWER STEERING
ADAPTERS
QUICK DISCONNECT COUPLERS
BALL VALVES
LIVE SWIVEL
ASSEMBLY FABRICATION
ACCESSORIES
EQUIPMENT AND PARTS
KITS
AIR BRAKE HOSE ASSY
BRASS

C	F\C	F
-68	-90	-130
-62	-80	-112
-57	-70	-94
-51	-60	-76
-46	-50	-58
-40	-40	-40
-34	-30	-22
-29	-20	-4
-23	-10	14
-17.8	0	32
-17.2	1	33.8
-16.7	2	35.6
-16.1	3	37.4
-15.6	4	39.2
-15.0	5	41.0
-14.4	6	42.8
-13.9	7	44.6
-13.3	8	46.4
-12.8	9	48.2
-12.2	10	50.0
-11.7	11	51.8
-11.1	12	53.6
-10.6	13	55.4
-10.0	14	57.2
-9.4	15	59.0
-8.9	16	60.8
-8.3	17	62.6
-7.8	18	64.4
-7.2	19	66.2
-6.7	20	68.0
-6.1	21	69.8
-5.6	22	71.6
-5.0	23	73.4
-4.4	24	75.2
-3.9	25	77.0
-3.3	26	78.8
-2.8	27	80.6
-2.2	28	82.4
-1.7	29	84.2
-1.1	30	86.0
-.6	31	87.8
0	32	89.6
.6	33	91.4
1.1	34	93.2
1.7	35	95.0
2.2	36	96.8
2.8	37	98.6
3.3	38	100.4
3.9	39	102.2
4.4	40	104.0

C	F\C	F
5.0	41	105.8
5.6	42	107.6
6.1	43	109.4
6.7	44	111.2
7.2	45	113.0
7.8	46	114.8
8.3	47	116.6
8.9	48	118.4
9.4	49	120.2
10.0	50	122.0
10.6	51	123.8
11.1	52	125.6
11.7	53	127.4
12.2	54	129.2
12.8	55	131.0
13.3	56	132.8
13.9	57	134.6
14.4	58	136.4
15.0	59	138.2
15.6	60	140.0
16.1	61	141.8
16.7	62	143.6
17.2	63	145.4
17.8	64	147.2
18.3	65	149.0
18.9	66	150.8
19.4	67	152.6
20.0	68	154.4
20.6	69	156.2
21.1	70	158.0
21.7	71	159.8
22.2	72	161.6
22.8	73	163.4
23.3	74	165.2
23.9	75	167.0
24.4	76	168.8
25.0	77	170.6
25.6	78	172.4
26.1	79	174.2
26.7	80	176.0
27.2	81	177.8
27.8	82	179.6
28.3	83	181.6
28.9	84	183.2
29.4	85	185.0
30.0	86	186.8
30.6	87	188.6
31.1	88	190.4
31.7	89	192.2
32.2	90	194.0
32.8	91	195.8

C	F\C	F
33.3	92	197.6
33.9	93	199.4
34.4	94	201.2
35.0	95	203.0
35.6	96	204.8
36.1	97	206.6
36.7	98	208.4
37.2	99	210.2
37.8	100	212.0
43	110	230
49	120	248
54	130	266
60	140	284
66	150	302
71	160	320
77	170	338
82	180	356
88	190	374
93	200	392
99	210	410
100	212	413.6
104	220	428
110	230	446
116	240	464
121	250	482
127	260	500
132	270	518
138	280	536
143	290	554
149	300	572
154	310	590
160	320	608
166	330	626
170	338	640
171	340	644
177	350	662
182	360	680
186	366	691
188	370	698
193	380	716
198	388	730
199	390	734
204	400	752
208	406	763
210	410	770
216	420	788
221	430	806
227	440	824
232	450	842



# PRESSURE CONVERSIONS

## Metric to PSI (1 kPa = .145 psi)

Kilo Pascals (kPa)	Mega Pascals (MPa)	Bar (Bar)	Pounds per Square Inch (psi)
100	0.1	1	14.5
200	0.2	2	29.0
300	0.3	3	43.5
400	0.4	4	58.0
500	0.5	5	72.5
600	0.6	6	87.0
700	0.7	7	101.5
800	0.8	8	116.0
900	0.9	9	130.5
1,000	1.0	10	145.0
2,000	2.0	20	290.1
3,000	3.0	30	435.1
4,000	4.0	40	580.2
5,000	5.0	50	725.2
6,000	6.0	60	870.2
7,000	7.0	70	1,015.3
8,000	8.0	80	1,160.3
9,000	9.0	90	1,305.3
10,000	10	100	1,450
20,000	20	200	2,901
30,000	30	300	4,351
40,000	40	400	5,802
50,000	50	500	7,252
60,000	60	600	8,702
70,000	70	700	10,153
80,000	80	800	11,603
90,000	90	900	13,053
100,000	100	1000	14,504
200,000	200	2000	29,008
300,000	300	3000	43,511

## PSI to Metric (1 psi = 6.89 kPa)

Pounds per Square Inch (psi)	Kilo Pascals (kPa)	Mega Pascals (MPa)	Bar (Bar)
10	68.9	0.07	0.7
20	137.9	0.14	1.4
30	206.8	0.21	2.1
40	275.8	0.28	2.8
50	344.7	0.34	3.4
60	413.7	0.41	4.1
70	482.6	0.48	4.8
80	551.6	0.55	5.5
90	620.5	0.62	6.2
100	689	0.7	6.9
200	1,379	1.4	13.8
300	2,068	2.1	20.7
400	2,758	2.8	27.6
500	3,447	3.4	34.5
600	4,137	4.1	41.4
700	4,826	4.8	48.3
800	5,516	5.5	55.2
900	6,205	6.2	62.1
1,000	6,895	6.9	68.9
2,000	13,790	13.8	137.9
3,000	20,684	20.7	206.8
4,000	27,579	27.6	275.8
5,000	34,474	34.5	344.7
6,000	41,369	41.4	413.7
7,000	48,263	48.3	482.6
8,000	55,158	55.2	551.6
9,000	62,053	62.1	620.5
10,000	68,948	68.9	689
20,000	137,895	137.9	1,379
30,000	206,843	206.8	2,068
40,000	275,790	275.8	2,758

### EXAMPLES

(A) Convert 3,429 psi to the equivalent pressure in Bar.

3,000 psi	=	206.8 Bar
+ 400 psi	=	27.6 Bar
+ 20 psi	=	1.4 Bar
+ 9 psi	=	.62 Bar
3429 psi	=	236.42 Bar

(B) Convert 3,429 psi to the equivalent pressure in MPa.

3,000 psi	=	20.680 MPa
+ 400 psi	=	2.760 MPa
+ 20 psi	=	.140 MPa
+ 9 psi	=	.062 MPa
3,429 psi	=	23.642 MPa

## FAHRENHEIT-CELSIUS CONVERSION

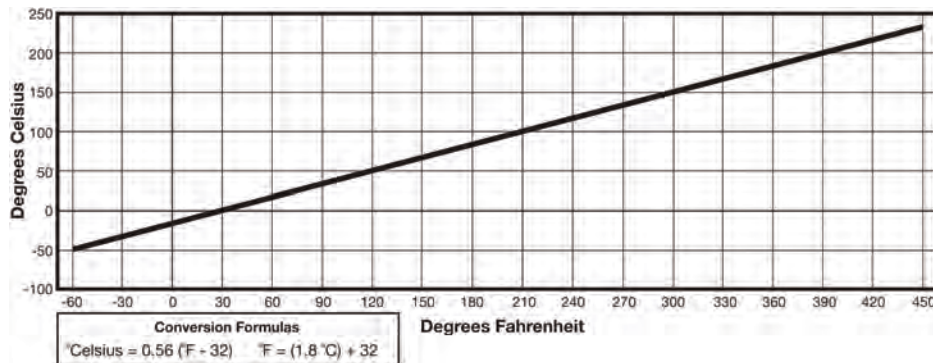

- EQUIPMENT
- HOSE/CPLG. SELECTION
- G8K COUPLINGS
- GLOBAL SPIRAL COUPLINGS
- STAINLESS STEEL SPIRAL
- MEGACRIMP COUPLINGS
- STAINLESS STEEL BRAID
- POWER CRIMP COUPLINGS
- FIELD ATTACHABLE G1 & G2 COUPLINGS
- FIELD ATTACHABLE C5 COUPLINGS
- C14 COUPLINGS
- GL COUPLINGS
- GLX COUPLINGS
- PCTS THERMOPLASTIC COUPLINGS
- POLARSEAL COUPLINGS (ACA)
- POLARSEAL II COUPLINGS (ACC)
- POLARSEAL II COUPLINGS (ACB)
- POWER STEERING
- ADAPTERS
- QUICK DISCONNECT COUPLERS
- BALL VALVES
- LIVE SWIVEL
- ASSEMBLY FABRICATION
- ACCESSORIES
- EQUIPMENT AND PARTS
- KITS
- AIR BRAKE HOSE ASSY
- BRASS



# DECIMAL AND MILLIMETER FRACTION EQUIVALENTS

EQUIPMENT
HOSE/CPLG. SELECTION
G8K COUPLINGS
GLOBAL SPIRAL COUPLINGS
STAINLESS STEEL SPIRAL
MEGACRIMP COUPLINGS
STAINLESS STEEL BRAID
POWER CRIMP COUPLINGS
FIELD ATTACHABLE G1 & G2 COUPLINGS
FIELD ATTACHABLE C5 COUPLINGS
C14 COUPLINGS
GL COUPLINGS
GLX COUPLINGS
PCTS THERMOPLASTIC COUPLINGS
POLARSEAL COUPLINGS (ACA)
POLARSEAL II COUPLINGS (ACC)
POLARSEAL II COUPLINGS (ACB)
POWER STEERING
ADAPTERS
QUICK DISCONNECT COUPLERS
BALL VALVES
LIVE SWIVEL
ASSEMBLY FABRICATION
ACCESSORIES
EQUIPMENT AND PARTS
KITS
AIR BRAKE HOSE ASSY
BRASS

	Inches			Inches			Inches		
	Fractions	Decimals	Millimeters	Fractions	Decimals	Millimeters	Fractions	Decimals	Millimeters
	1/64	.015625	.397	23/64	.359375	9.128	11/16	.6875	17.463
	1/32	.03125	.794	3/8	.375	9.525	45/64	.703125	17.859
	3/64	.046875	1.191	25/64	.390625	9.922	23/32	.71875	18.256
	1/16	.0625	1.588	13/32	.40625	10.319	47/64	.734375	18.653
	5/64	.078125	1.984	27/64	.421875	10.716	3/4	.750	19.050
	3/32	.09375	2.381	7/16	.4375	11.113	49/64	.765625	19.447
	7/64	.109375	2.778	29/64	.453125	11.509	25/32	.78125	19.844
	1/8	.125	3.175	15/32	.46875	11.906	51/64	.796875	20.241
	9/64	.140625	3.572	31/64	.484375	12.303	13/16	.8125	20.638
	5/32	.15625	3.969	1/2	.500	12.700	53/64	.828125	21.034
	11/64	.171875	4.366	33/64	.515625	13.097	27/32	.84375	21.431
	3/16	.1875	4.763	17/32	.53125	13.494	55/64	.859375	21.828
	13/64	.203125	5.159	35/64	.546875	13.891	7/8	.875	22.225
	7/32	.21875	5.556	9/16	.5625	14.288	57/64	.890625	22.622
	15/64	.234375	5.953	37/64	.578125	14.684	29/32	.90625	23.019
	1/4	.250	6.350	19/32	.59375	15.081	59/64	.921875	23.416
	17/64	.265625	6.747	39/64	.609375	15.478	15/16	.9375	23.813
	9/32	.28125	7.144	5/8	.625	15.875	61/64	.953125	24.209
	19/64	.296875	7.541	41/64	.640625	16.272	31/32	.96875	24.606
	5/16	.3125	7.938	21/32	.65625	16.669	63/64	.984375	25.003
							1	1.000	25.400

## METRIC (SI) — U.S. UNITS FOR FLUID POWER USE

(The following conversions are based on information taken from ASTM, American Society for Testing and Materials, Handbook E380-72.)

Quantity	Customary U.S. Unit	SI Unit	Conversion from U.S. to SI Units	Conversion from SI to U.S. Units
Area	Square Inch (in <sup>2</sup> )	Square Metre (m <sup>2</sup> )	(in <sup>2</sup> ) x (6.4516 x 10 <sup>-4</sup> ) = (m <sup>2</sup> )	(m <sup>2</sup> ) x 1550.003 = (in <sup>2</sup> )
Force	Pound (lb <sub>f</sub> )	Newton (N)	(lbf) x 4.4482 = (N)	(N) x (2.2481 x 10 <sup>-1</sup> ) = (lb <sub>f</sub> )
Frequency	Cycles/Second (cps)	Hertz (H <sub>z</sub> )	1 (cps) = 1(H <sub>z</sub> )	1(Hz) = 1(cps)
Length	Inch (in)	Metre (m)	(in) x (2.540 x 10 <sup>-2</sup> ) = (m)	(m) x 39.370 = (in)
Mass	Pound (lb <sub>m</sub> )	Kilogram (kg)	(lbm) x .4536 = (kg)	(kg) x 2.2046 = (lb <sub>m</sub> )
Power	Electric Horsepower (HP)	Watt (W)	(HP) x (7.460 x 10 <sup>2</sup> ) = (W)	(W) x (1.3405 x 10 <sup>-3</sup> ) = (HP)
	Pounds/Sq In (psi)	Newtons/Sq Metre (N/m <sup>2</sup> )	(psi) x (6.8948 x 10 <sup>3</sup> ) = (N/m <sup>2</sup> )	(N/m <sup>2</sup> ) x (1.4504 x 10 <sup>-4</sup> ) = (psi)
Pressure			(Non-Preferred Conversions)	
	(psi)	Mega Pascal (MPa)	(psi)/145 = MPa	(MPa) x 145 = (psi)
	(psi)	Bar (Bar)	psi/14.5 = Bar	(Bar) x (1.4504 x 10 <sup>1</sup> ) = (psi)
	(Bar)	(N/m <sup>2</sup> )	(Bar) x 100,000 = (N/m <sup>2</sup> )	(N/m <sup>2</sup> ) x (1.00 x 10 <sup>-5</sup> ) = (Bar)
Temperature	Degrees Fahrenheit (°F)	Degrees Celsius (°C)	(°Celsius) = 0.556(°F-32)	(1.8°C) + 32 = °F
Torque	Pound-Inch (lb <sub>f</sub> -in)	Newton-Metres (N-m)	(lb <sub>f</sub> -in) x (1.1298 x 10 <sup>-1</sup> ) = (N-m)	(N-m) x 8.8507 = (lb <sub>f</sub> -in)
	US Gallon (Gal)	Cubic Metre (m <sup>3</sup> )	(Gal) x (3.7854 x 10 <sup>-3</sup> ) = (m <sup>3</sup> )	(m <sup>3</sup> ) x (2.6417 x 10 <sup>2</sup> ) = (Gal)
Volume			(Non-Preferred Conversions)	
		Litre (l)	(Gal) x 3.7854 = (l)	(l) x (2.6417 x 10 <sup>-1</sup> ) = (Gal)
Work	Foot-Pound (ft-lb <sub>f</sub> )	Joule (J)	(ft-lb <sub>f</sub> ) x 1.3558 = (J)	(J) x (7.3756 x 10 <sup>-1</sup> ) = (ft-lb <sub>f</sub> )



# TIGHTENING AND TORQUE RECOMMENDATIONS FOR HYDRAULIC COUPLINGS

1. Determine the correct torque value for your coupling using the manufacturers' recommendations. The minimum torque values are adequate for sealing in most applications; never exceed the maximum torque recommendations. Only use manufacturer specified torque values; do not use SAE recommendations.
2. Calculated the correct torque wrench setting. Wrench Setting = Desired Torque \* L / LA (see Figure 1)
3. Ensure that the seal face and threads are clean and in good condition. O-rings should be lubricated with light oil, but threads should be completely dry unless making a tapered pipe thread connection (interference seal).
4. If the assembly has a male connector on one end, install the male connector first.
5. Hand tighten the connection by bringing seal face in contact and rotating the nut by hand until it stops, approximately 0.3-1 ft-lb.
6. Mark the coupling nut and backup hex with a line for flats method of torque verification.
7. Apply a wrench to the backup hex to prevent the coupling and hose from moving while tightening the nut with a torque wrench. Failure to retain the backup hex during installation can cause hose twisting and will result in additional clamp load force that can cause seal face damage.
8. While keeping the backup hex secure apply the torque wrench to the fitting nut and pull until the proper torque is achieved. The coupling nut must be in motion when the final torque is achieved, otherwise the nut must be loosened and retightened until the torque is attained while the nut is in motion.
9. If a torque wrench cannot fit into the coupling area or if it is unavailable, flats method may be used to ensure that JIC couplings are properly tightened, as shown in figure 2. Checking flats is also a good method of ensuring that critical connections have been properly tightened.

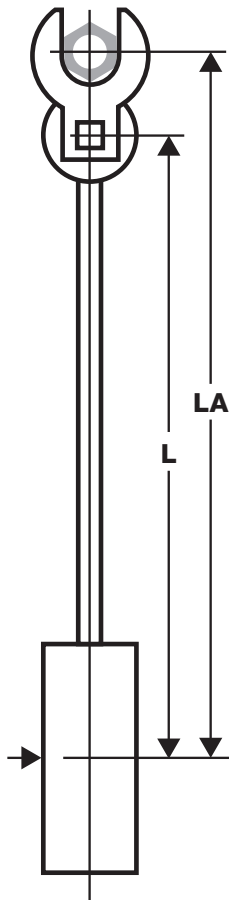

**Figure 1** - Torque wrench adjustment when using a crowfoot wrench. Torque Wrench Setting = Desired Torque \* L / LA

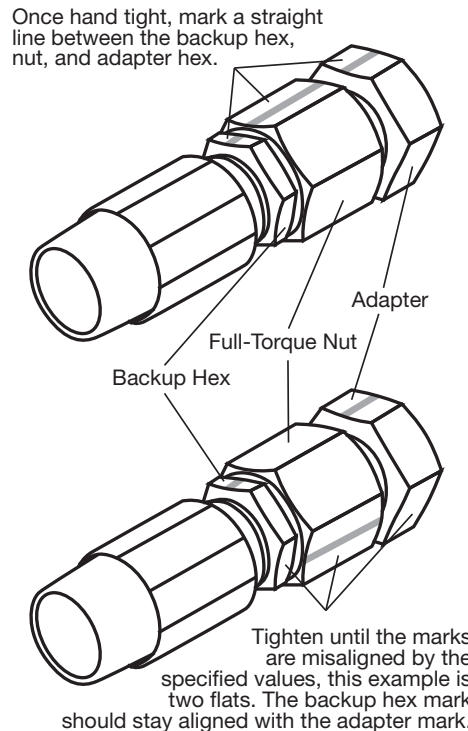

**Figure 2** - Flats method of verifying coupling torque.

EQUIPMENT
HOSE/CPLG. SELECTION
G8K COUPLINGS
GLOBALSPIRAL COUPLINGS
STAINLESS STEEL SPIRAL
MEGACRIMP COUPLINGS
STAINLESS STEEL BRAID
POWER CRIMP COUPLINGS
FIELD ATTACHABLE G1 & G2 COUPLINGS
FIELD ATTACHABLE C5 COUPLINGS
C14 COUPLINGS
GL COUPLINGS
GLX COUPLINGS
PCTS THERMOPLASTIC COUPLINGS
POLARSEAL COUPLINGS (ACA)
POLARSEAL II COUPLINGS (ACC)
POLARSEAL II COUPLINGS (ACB)
POWER STEERING
ADAPTERS
QUICK DISCONNECT COUPLERS
BALL VALVES
LIVE SWIVEL
ASSEMBLY FABRICATION
ACCESSORIES
EQUIPMENT AND PARTS
KITS
AIR BRAKE HOSE ASSY
BRASS



**JIC, SAE 45°, ORFS, O-RING BOSS, GATES ADAPTERLESS, & MEGASEAL®**

Dash Size	JIC 37°, SAE 45° & MegaSeal (Steel)		JIC 37°, SAE 45° & MegaSeal (Brass)		Flat Face O-Ring Seal (Steel)		SAE O-Ring Boss (Steel) & Gates Adapterless ≤ 4000 PSI		SAE O-Ring Boss (Steel) & Gates Adapterless > 4000 PSI	
	lb-ft		lb-ft		lb-ft		lb-ft		lb-ft	
1/16 inch	Min	Max	Min	Max	Min	Max	Min	Max	Min	Max
-3	8	10	5	7			7	9	7	9
-4	11	14	7	9	18	23	13	17	15	18
-5	14	18	9	11	22	28	18	23	18	23
-6	18	22	11	14	29	37	22	28	26	32
-8	36	45	23	29	41	51	37	46	52	64
-10	57	71	37	46	44	55	44	55	74	92
-12	79	99	51	64	66	83	70	88	125	157
-14	94	117	61	76			92	115	158	198
-16	108	135	70	88	92	115	111	138	199	249
-20	127	158	82	103	125	157	147	184	210	263
-24	158	198	103	129	147	184	155	193	273	341
-32	245	306	159	199	376	470	221	276	398	497

EQUIPMENT
HOSE/CP/LG. SELECTION
G8K COUPLINGS
GLOBAL SPIRAL COUPLINGS
STAINLESS STEEL SPIRAL
MEGACRIMP COUPLINGS
STAINLESS STEEL BRAID
POWER CRIMP COUPLINGS
FIELD ATTACHABLE G1 & G2 COUPLINGS
FIELD ATTACHABLE C5 COUPLINGS
C14 COUPLINGS
GL COUPLINGS
GLX COUPLINGS
PCTS THERMOPLASTIC COUPLINGS
POLARSEAL COUPLINGS (ACA)
POLARSEAL II COUPLINGS (ACC)
POLARSEAL II COUPLINGS (ACB)
POWER STEERING
ADAPTERS
QUICK DISCONNECT COUPLERS
BALL VALVES
LIVE SWIVEL
ASSEMBLY FABRICATION
ACCESSORIES
EQUIPMENT AND PARTS
KITS
AIR BRAKE HOSE ASSY
BRASS

**DIN 24/60 & INVERTED CONE**

Size		Torque	
mm		lb-ft	
Light Tube O.D.	Heavy Tube O.D.	Min	Max
6		7	15
8		15	26
10	8	18	30
12	10	22	33
14	12	26	37
15	14	30	52
	16	30	52
18		44	74
22	20	59	89
28	25	74	111
	30	74	162
35		133	184
42	38	148	221

**BSP 30° & JIS**

Dash Size	Torque	
	lb-ft	
1/16 inch	Min	Max
-2	7	9
-4	11	18
-6	19	28
-8	30	36
-10	37	44
-12	50	60
-16	79	95
-20	127	152
-24	167	190
-32	262	314

**4-BOLT FLANGES**

Dash Size	Bolt Size	Torque
1/16 inch	inch	lb-ft
-8	0.31	24
-12	0.38	44
-16	0.44	44
-20	0.5	68
-24	0.63	111
-32	0.75	111

Note:  
 1. Align faces and finger tighten bolts before applying final torque in a pattern. The seal faces must be parallel with even bolt tension to seal properly.  
 2. Torque values apply to bolts which are plated or coated in light engine oil.  
 3. Before assembly lubricate o-ring with light oil (SAE 10W or 20W).

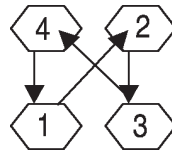

**SAE MALE FLARELESS ASSEMBLY (MFA)**

After hand tight (when the sleeve bites the tube) rotate nut one full turn (eight flats).

**NPTF**

Dash Size	Max Torque
1/16 inch	lb-ft
-2	20
-4	25
-6	35
-8	45
-12	55
-16	65
-20	80
-24	95
-32	120

Note:  
 1. The torque values obtained from tightening pipe threads can vary considerably depending on thread condition. Adequate sealing can occur at values much lower than the maximum values listed above. Only enough torque to achieve adequate sealing should be used.  
 2. When using a male tapered pipe thread with a female straight or parallel pipe thread, maximum values are 50% of those listed in the table.  
 3. If thread sealant is used, maximum values shown should be decreased by 25%.

**FLATS METHOD VALUES**

Termination Type	Dash Size	Flats
	1/16 in	
JIS	-4	0.5 – 1.5
JIC	-4	1.5 – 1.75
JIC	-6	1.0 – 1.5
JIC	-8	1.5 – 1.75
JIC	-10	1.0 – 1.5
JIC	-12	1.0 – 1.5
JIC	-16	.75 – 1.0
JIC	-20	.75 – 1.0
JIC	-24	.75 – 1.0
JIC	-32	.75 – 1.0

Note:  
 1. Seal faces must be in contact and the fitting fully hand tightened before marking flats.  
 2. Flats method is most accurate for the first assembly cycle, for multiple disassembly/assembly cycles torque values are more reliable.  
 3. Tightening two flats or more is analogous to severe over torque and may damage seal faces.

Conversion	Formula
lbf-ft to N-m	[lbf-ft]*1.3558 = [N-m]
lbf-ft to lb-in	[lbf-ft]*12 = [lb-in]
N-m to lb-in	[N-m]*8.8508 = [lb-in]



# HYDRAULIC HOSE FOR G8K COUPLINGS



**The Gates eCrimp program** is a web based utility which allows users and distributors of Gates hydraulic and industrial hose products to find and print the most up to date crimp specifications with nothing more than an internet browser.

This program can be used to find crimp data for all Gates crimpers. Custom result may be printed by selecting the crimper, hose and coupling. Optionally results may also be limited by die set and working pressure.

The eCrimp web application can be directly accessed from a web browser by entering <http://eCrimp.Gates.com> for the website.

**The eCrimp mobile app** is available for download for the iPhone and iPad from the App Store.

EQUIPMENT
HOSE/CPLG. SELECTION
<b>G8K COUPLINGS</b>
GLOBALSPIRAL COUPLINGS
STAINLESS STEEL SPIRAL
MEGACRIMP COUPLINGS
STAINLESS STEEL BRAID
POWER CRIMP COUPLINGS
FIELD ATTACHABLE G1 & G2 COUPLINGS
FIELD ATTACHABLE C5 COUPLINGS
C14 COUPLINGS
GL COUPLINGS
GLX COUPLINGS
PCTS THERMOPLASTIC COUPLINGS
POLARSEAL COUPLINGS (ACA)
POLARSEAL II COUPLINGS (ACC)
POLARSEAL II COUPLINGS (ACB)
POWER STEERING
ADAPTERS
QUICK DISCONNECT COUPLERS
BALL VALVES
LIVE SWIVEL
ASSEMBLY FABRICATION
ACCESSORIES
EQUIPMENT AND PARTS
KITS
AIR BRAKE HOSE ASSY
BRASS





EQUIPMENT
HOSE/CPLG. SELECTION
<b>G8K COUPLINGS</b>
GLOBAL SPIRAL COUPLINGS
STAINLESS STEEL SPIRAL
MEGACRIMP COUPLINGS
STAINLESS STEEL BRAID
POWER CRIMP COUPLINGS
FIELD ATTACHABLE G1 & G2 COUPLINGS
FIELD ATTACHABLE C5 COUPLINGS
C14 COUPLINGS
GL COUPLINGS
GLX COUPLINGS
PCTS THERMOPLASTIC COUPLINGS
POLARSEAL COUPLINGS (ACA)
POLARSEAL II COUPLINGS (ACC)
POLARSEAL II COUPLINGS (ACB)
POWER STEERING
ADAPTERS
QUICK DISCONNECT COUPLERS
BALL VALVES
LIVE SWIVEL
ASSEMBLY FABRICATION
ACCESSORIES
EQUIPMENT AND PARTS
KITS
AIR BRAKE HOSE ASSY
BRASS

### Caterpillar Style O-Ring Flange

Compatible with Code 62 O-Ring. See Accessories for recommended O-Rings. (Do Not use "D" shaped O-Rings)

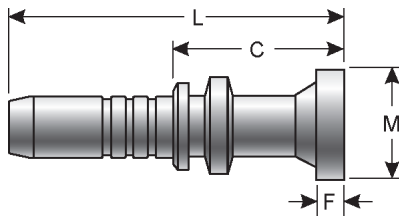

Part No.	Descr.	Prod. No.	⊖		M		L		C		F	
			"	mm	"	mm	"	mm	"	mm	"	mm
G19400-1212	12G8K-12FLC	7347-80215	3/4	19.1	1.62	41.2	5.93	150.6	2.95	75.0	.56	14.2
G19400-1616	16G8K-16FLC	7347-80015	1	25.4	1.87	47.5	5.64	143.3	2.96	75.2	.56	14.2

### Caterpillar Style O-Ring Flange - 45° Bent Tube

Compatible with Code 62 O-Ring. See Accessories for recommended O-Rings. (Do Not use "D" shaped O-Rings)

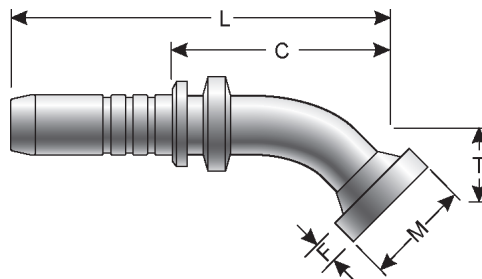

Part No.	Descr.	Prod. No.	⊖		M		T		L		C		F	
			"	mm	"	mm	"	mm	"	mm	"	mm	"	mm
G19407-1212	12G8K-12FLC45-034	7347-80225	3/4	19.1	1.62	41.2	1.35	34.3	6.65	168.9	3.68	93.5	.56	14.2
G19407-1616	16G8K-16FLC45-050	7347-80025	1	25.4	1.87	47.5	1.97	50.0	7.76	197.1	5.08	129.0	.56	14.2



### Caterpillar Style O-Ring Flange - 90° Bent Tube

Compatible with Code 62 O-Ring. See Accessories for recommended O-Rings. (Do Not use "D" shaped O-Rings)

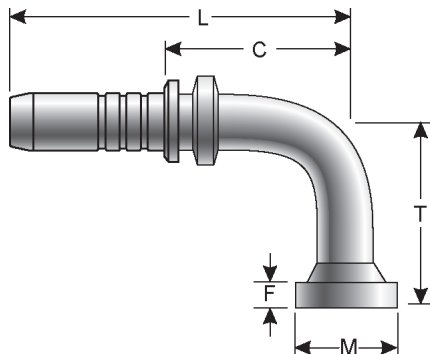

Part No.	Descr.	Prod. No.	⊖		M		T		L		C		F	
			"	mm	"	mm	"	mm	"	mm	"	mm	"	mm
G19415-1212	12G8K-12FLC90-070	7347-80235	3/4	19.1	1.62	41.2	2.76	70.1	6.18	157.0	3.22	81.8	.56	14.2
G19415-1616	16G8K-16FLC90-093	7347-80055	1	25.4	1.87	47.5	3.66	93.0	6.46	164.1	3.79	96.3	.56	14.2
G19416-1616	16G8K-16FLC90-117	7347-80045	1	25.4	1.87	47.5	4.61	117.1	6.46	164.1	3.79	96.3	.56	14.2

### G8K Ferrule for G8K Spiral Hose

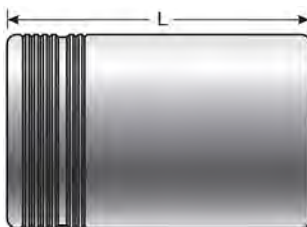

Part No.	Descr.	Prod. No.	⊖		L	
			"	mm	"	mm
G19995-0012	12G8K1F	7347-80205	3/4	19.1	2.56	65.0
G19995-0016	16G8K1F	7347-80065	1	25.4	2.60	66.0

- EQUIPMENT
- HOSE/CPLG. SELECTION
- G8K COUPLINGS**
- GLOBALSPIRAL COUPLINGS
- STAINLESS STEEL SPIRAL
- MEGACRIMP COUPLINGS
- STAINLESS STEEL BRAID
- POWER CRIMP COUPLINGS
- FIELD ATTACHABLE G1 & G2 COUPLINGS
- FIELD ATTACHABLE C5 COUPLINGS
- C14 COUPLINGS
- GL COUPLINGS
- GLX COUPLINGS
- PCTS THERMOPLASTIC COUPLINGS
- POLARSEAL COUPLINGS (ACA)
- POLARSEAL II COUPLINGS (ACC)
- POLARSEAL II COUPLINGS (ACB)
- POWER STEERING
- ADAPTERS
- QUICK DISCONNECT COUPLERS
- BALL VALVES
- LIVE SWIVEL
- ASSEMBLY FABRICATION
- ACCESSORIES
- EQUIPMENT AND PARTS
- KITS
- AIR BRAKE HOSE ASSY
- BRASS



NOTES

EQUIPMENT
HOSE/CPLG. SELECTION
<b>G8K COUPLINGS</b>
GLOBAL SPIRAL COUPLINGS
STAINLESS STEEL SPIRAL
MEGACRIMP COUPLINGS
STAINLESS STEEL BRAID
POWER CRIMP COUPLINGS
FIELD ATTACHABLE G1 & G2 COUPLINGS
FIELD ATTACHABLE C5 COUPLINGS
C14 COUPLINGS
GL COUPLINGS
GLX COUPLINGS
PCTS THERMOPLASTIC COUPLINGS
POLARSEAL COUPLINGS (ACA)
POLARSEAL II COUPLINGS (ACC)
POLARSEAL II COUPLINGS (ACB)
POWER STEERING
ADAPTERS
QUICK DISCONNECT COUPLERS
BALL VALVES
LIVE SWIVEL
ASSEMBLY FABRICATION
ACCESSORIES
EQUIPMENT AND PARTS
KITS
AIR BRAKE HOSE ASSY
BRASS



# HYDRAULIC HOSE FOR GLOBALSPIRAL™ COUPLINGS



Also available with MegaTuff® cover



Also available with MegaTuff® cover



Also available with MegaTuff® and XtraTuff® cover



Also available with MegaTuff® and XtraTuff® cover



Also available with MegaTuff® and XtraTuff® cover



Also available with MegaTuff® cover



Also available with MegaTuff® and XtraTuff® cover



Also available with MegaTuff® and XtraTuff® cover



Also available with MegaTuff® cover

EQUIPMENT
HOSE/CPLG. SELECTION
G8K COUPLINGS
GLOBALSPIRAL COUPLINGS
STAINLESS STEEL SPIRAL
MEGACRIMP COUPLINGS
STAINLESS STEEL BRAID
POWER CRIMP COUPLINGS
FIELD ATTACHABLE G1 & G2 COUPLINGS
FIELD ATTACHABLE C5 COUPLINGS
C14 COUPLINGS
GL COUPLINGS
GLX COUPLINGS
PCTS THERMOPLASTIC COUPLINGS
POLARSEAL COUPLINGS (ACA)
POLARSEAL II COUPLINGS (ACC)
POLARSEAL II COUPLINGS (ACB)
POWER STEERING
ADAPTERS
QUICK DISCONNECT COUPLERS
BALL VALVES
LIVE SWIVEL
ASSEMBLY FABRICATION
ACCESSORIES
EQUIPMENT AND PARTS
KITS
AIR BRAKE HOSE ASSY
BRASS



EQUIPMENT
HOSE/CPLG. SELECTION
G8K COUPLINGS
GLOBALSPIRAL COUPLINGS
STAINLESS STEEL SPIRAL
MEGACRIMP COUPLINGS
STAINLESS STEEL BRAID
POWER CRIMP COUPLINGS
FIELD ATTACHABLE G1 & G2 COUPLINGS
FIELD ATTACHABLE C5 COUPLINGS
C14 COUPLINGS
GL COUPLINGS
GLX COUPLINGS
PCTS THERMOPLASTIC COUPLINGS
POLARSEAL COUPLINGS (ACA)
POLARSEAL II COUPLINGS (ACC)
POLARSEAL II COUPLINGS (ACB)
POWER STEERING
ADAPTERS
QUICK DISCONNECT COUPLERS
BALL VALVES
LIVE SWIVEL
ASSEMBLY FABRICATION
ACCESSORIES
EQUIPMENT AND PARTS
KITS
AIR BRAKE HOSE ASSY
BRASS

## HYDRAULIC HOSE FOR GLOBALSPIRAL™ COUPLINGS - CONTINUED



Also available with MegaTuff® and XtraTuff® cover



Also available with MegaTuff® and XtraTuff® cover

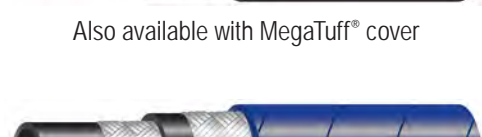

For GlobalSpiral™ Plus Couplings



For GlobalSpiral™ Plus Couplings





# HYDRAULIC HOSE FOR GLOBALSPIRAL™ COUPLINGS - CONTINUED



For GlobalSpiral™ Plus Couplings



Also available with MegaTuff® cover. For GlobalSpiral™ Plus Couplings



For GlobalSpiral™ Plus Couplings



**The Gates eCrimp program** is a web based utility which allows users and distributors of Gates hydraulic and industrial hose products to find and print the most up to date crimp specifications with nothing more than an internet browser.

This program can be used to find crimp data for all Gates crimpers. Custom result may be printed by selecting the crimper, hose and coupling. Optionally results may also be limited by die set and working pressure.

The eCrimp web application can be directly accessed from a web browser by entering <http://eCrimp.Gates.com> for the website.

**The eCrimp mobile app** is available for download for the iPhone and iPad from the App Store.

EQUIPMENT
HOSE/CPLG. SELECTION
G8K COUPLINGS
GLOBALSPIRAL COUPLINGS
STAINLESS STEEL SPIRAL
MEGACRIMP COUPLINGS
STAINLESS STEEL BRAID
POWER CRIMP COUPLINGS
FIELD ATTACHABLE G1 & G2 COUPLINGS
FIELD ATTACHABLE C5 COUPLINGS
C14 COUPLINGS
GL COUPLINGS
GLX COUPLINGS
PCTS THERMOPLASTIC COUPLINGS
POLARSEAL COUPLINGS (ACA)
POLARSEAL II COUPLINGS (ACC)
POLARSEAL II COUPLINGS (ACB)
POWER STEERING
ADAPTERS
QUICK DISCONNECT COUPLERS
BALL VALVES
LIVE SWIVEL
ASSEMBLY FABRICATION
ACCESSORIES
EQUIPMENT AND PARTS
KITS
AIR BRAKE HOSE ASSY
BRASS





EQUIPMENT
HOSE/CPLG. SELECTION
G8K COUPLINGS
<b>GLOBALSPIRAL COUPLINGS</b>
STAINLESS STEEL SPIRAL
MEGACRIMP COUPLINGS
STAINLESS STEEL BRAID
POWER CRIMP COUPLINGS
FIELD ATTACHABLE G1 & G2 COUPLINGS
FIELD ATTACHABLE C5 COUPLINGS
C14 COUPLINGS
GL COUPLINGS
GLX COUPLINGS
PCTS THERMOPLASTIC COUPLINGS
POLARSEAL COUPLINGS (ACA)
POLARSEAL II COUPLINGS (ACC)
POLARSEAL II COUPLINGS (ACB)
POWER STEERING
ADAPTERS
QUICK DISCONNECT COUPLERS
BALL VALVES
LIVE SWIVEL
ASSEMBLY FABRICATION
ACCESSORIES
EQUIPMENT AND PARTS
KITS
AIR BRAKE HOSE ASSY
BRASS

### Male Pipe (NPTF - 30° Cone Seat)



Part No.	Descr.	Prod. No.	⊖		H1	L		C		
			"	mm		"	mm	"	mm	
G20100-0606	6GS-6MP	7347-20145	3/8	9.5	3/8-18	11/16	2.72	69.1	1.31	33.3
G20100-0608	6GS-8MP	7347-20155	3/8	9.5	1/2-14	7/8	2.87	72.9	1.46	37.1
G20100-0808	8GS-8MP	7347-20245	1/2	12.7	1/2-14	7/8	2.91	73.9	1.43	36.3
G20100-0812	8GS-12MP	7347-20265	1/2	12.7	3/4-14	1 1/16	3.03	77.0	1.56	39.6
G20100-1008	10GS-8MP	7347-20335	5/8	15.9	1/2-14	15/16	3.35	85.1	1.34	34.0
G20100-1012	10GS-12MP	7347-20355	5/8	15.9	3/4-14	1 1/8	3.58	90.9	1.60	40.6
G20100-1208	12GS-8MP	7347-20425	3/4	19.1	1/2-14	1 1/16	3.54	89.9	1.54	39.1
G20100-1212	12GS-12MP	7347-20445	3/4	19.1	3/4-14	1 1/16	3.54	89.9	1.54	39.1
G20100-1216	12GS-16MP	7347-20465	3/4	19.1	1-11 1/2	1 3/8	3.82	97.0	1.81	46.0
G20100-1612	16GS-12MP	7347-20535	1	25.4	3/4-14	1 3/8	3.98	101.1	1.74	44.2
G20100-1616	16GS-16MP	7347-20555	1	25.4	1-11 1/2	1 3/8	4.17	105.9	1.94	49.3
G20100-1620	16GS-20MP	7347-20565	1	25.4	1 1/4-11 1/2	1 3/4	4.29	109.0	2.06	52.3
G20100-2020	20GS-20MP	7347-20645	1 1/4	31.8	1 1/4-11 1/2	1 3/4	5.00	127.0	2.20	55.9

### API Line Pipe Connection



Part No.	Descr.	Prod. No.	⊖		H1	L		C		
			"	mm		"	mm	"	mm	
G20102-2020	20GS-20API-LP	7347-76955	1 1/4	31.8	1 1/4-11 1/2	1 3/4	5.51	140.0	2.70	68.6



### Male Pipe (NPTF - 30° Cone Seat) - Long Hex



Part No.	Descr.	Prod. No.	⊖		H1	L		C		
			"	mm		"	"	mm	"	mm
G20103-1616	16GS-16MPLH	7347-76545	1	25.4	1-11 1/2	1 3/8	5.16	131.1	2.92	74.2

### Male O-Ring Boss

SAE J1926/2 ISO 11926-2 Heavy Duty (S Series) Stud End.



Part No.	Descr.	Prod. No.	⊖		H1	L		C		
			"	mm		"	"	mm	"	mm
G20120-0606	6GS-6MB	7347-21145	3/8	9.5	9/16-18	11/16	2.56	65.0	1.15	29.2
G20120-0808	8GS-8MB	7347-21245	1/2	12.7	3/4-16	7/8	2.76	70.1	1.26	32.0
G20120-0810	8GS-10MB	7347-21255	1/2	12.7	7/8-14	1	2.83	71.9	1.34	34.0
G20120-1010	10GS-10MB	7347-21345	5/8	15.9	7/8-14	1	3.46	87.9	1.48	37.6
G20120-1012	10GS-12MB	7347-21355	5/8	15.9	1 1/16-12	1 1/4	3.46	87.9	1.48	37.6
G20120-1212	12GS-12MB	7347-21445	3/4	19.1	1 1/16-12	1 1/4	3.66	93.0	1.65	41.9
G20120-1216	12GS-16MB	7347-21465	3/4	19.1	1 5/16-12	1 1/2	3.54	89.9	1.54	39.1
G20120-1612	16GS-12MB	7347-21535	1	25.4	1 1/16-12	1 3/8	3.98	101.1	1.74	44.2
G20120-1616	16GS-16MB	7347-21555	1	25.4	1 5/16-12	1 1/2	3.86	98.1	1.62	41.2
G20120-1620	16GS-20MB	7347-21565	1	25.4	1 5/8-12	1 7/8	4.53	115.1	1.62	41.2
G20120-2020	20GS-20MB	7347-21645	1 1/4	31.8	1 5/8-12	1 7/8	4.53	115.1	1.73	43.9

EQUIPMENT
HOSE/CPLG. SELECTION
G8K COUPLINGS
GLOBALSPIRAL COUPLINGS
STAINLESS STEEL SPIRAL
MEGACRIMP COUPLINGS
STAINLESS STEEL BRAID
POWER CRIMP COUPLINGS
FIELD ATTACHABLE G1 & G2 COUPLINGS
FIELD ATTACHABLE C5 COUPLINGS
C14 COUPLINGS
GL COUPLINGS
GLX COUPLINGS
PCTS THERMOPLASTIC COUPLINGS
POLARSEAL COUPLINGS (ACA)
POLARSEAL II COUPLINGS (ACC)
POLARSEAL II COUPLINGS (ACB)
POWER STEERING
ADAPTERS
QUICK DISCONNECT COUPLERS
BALL VALVES
LIVE SWIVEL
ASSEMBLY FABRICATION
ACCESSORIES
EQUIPMENT AND PARTS
KITS
AIR BRAKE HOSE ASSY
BRASS

EQUIPMENT
HOSE/CPLG. SELECTION
G8K COUPLINGS
<b>GLOBALSPIRAL COUPLINGS</b>
STAINLESS STEEL SPIRAL
MEGACRIMP COUPLINGS
STAINLESS STEEL BRAID
POWER CRIMP COUPLINGS
FIELD ATTACHABLE G1 & G2 COUPLINGS
FIELD ATTACHABLE C5 COUPLINGS
C14 COUPLINGS
GL COUPLINGS
GLX COUPLINGS
PCTS THERMOPLASTIC COUPLINGS
POLARSEAL COUPLINGS (ACA)
POLARSEAL II COUPLINGS (ACC)
POLARSEAL II COUPLINGS (ACB)
POWER STEERING
ADAPTERS
QUICK DISCONNECT COUPLERS
BALL VALVES
LIVE SWIVEL
ASSEMBLY FABRICATION
ACCESSORIES
EQUIPMENT AND PARTS
KITS
AIR BRAKE HOSE ASSY
BRASS

## Female MegaSeal® Swivel

Gates High Performance Replacement for Female JIC Fittings – Connects to Standard Male JIC Termination.

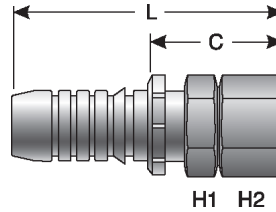

Part No.	Descr.	Prod. No.	⊖		🌀	H1	H2	L		C	
			"	mm				"	"	"	mm
G20140-1212	12GS-12FMX	7347-69445	3/4	19.1	1 1/16-12	1 1/8	1 1/4	4.02	102.1	2.02	51.3
G20140-1216	12GS-16FMX	7347-69465	3/4	19.1	1 5/16-12	1 1/8	1 1/2	4.06	103.1	2.06	52.3
G20140-1616	16GS-16FMX	7347-69555	1	25.4	1 5/16-12	1 1/2	1 1/2	4.37	111.0	2.15	54.6
G20140-2020	20GS-20FMX	7347-69645	1 1/4	31.8	1 5/8-12	1 7/8	2	5.36	136.1	2.56	65.0

## Female MegaSeal® Swivel - 45° Bent Tube

Gates High Performance Replacement for Female JIC Fittings – Connects to Standard Male JIC Termination.

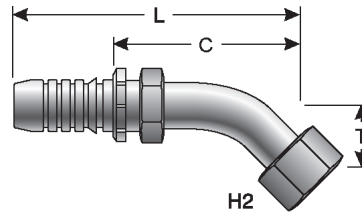

Part No.	Descr.	Prod. No.	⊖		🌀	H2	T		L		C	
			"	mm			"	mm	"	mm	"	mm
G20145-1212	12GS-12FMX45-032	7347-73275	3/4	19.1	1 1/16-12	1 1/4	1.26	32.0	5.08	129.0	3.07	78.0
G20145-1616	16GS-16FMX45-038	7347-70555	1	25.4	1 5/16-12	1 1/2	1.50	38.1	6.26	159.0	4.04	102.6
G20145-2020	20GS-20FMX45-041	7347-70645	1 1/4	31.8	1 5/8-12	2	1.61	40.9	7.47	189.7	4.67	118.6



## Female MegaSeal® Swivel - 90° Bent Tube

Gates High Performance Replacement for Female JIC Fittings – Connects to Standard Male JIC Termination.

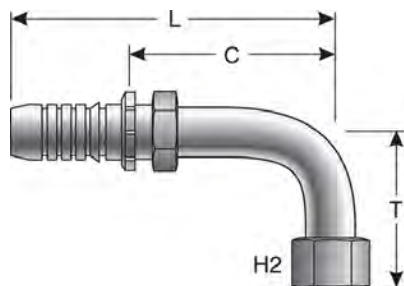

Part No.	Descr.	Prod. No.	⊖		H2	T		L		C		
			"	mm		"	mm	"	mm	"	mm	
G20149-1212	12GS-12FMX90-048	7347-71445	3/4	19.1	1 1/16-12	1 1/4	1.89	48.0	4.72	119.9	2.72	69.1
G20150-1212	12GS-12FMX90-058	7347-71395	3/4	19.1	1 1/16-12	1 1/4	2.28	57.9	4.72	119.9	2.72	69.1
G20151-1212	12GS-12FMX90-096	7347-71405	3/4	19.1	1 1/16-12	1 1/4	3.78	96.0	4.72	119.9	2.72	69.1
G20150-1216	12GS-16FMX90-056	7347-71465	3/4	19.1	1 5/16-12	1 1/2	2.20	55.9	5.39	136.9	3.39	86.1
G20149-1616	16GS-16FMX90-056	7347-71555	1	25.4	1 5/16-12	1 1/2	2.20	55.9	5.67	144.0	3.45	87.6
G20150-1616	16GS-16FMX90-071	7347-71505	1	25.4	1 5/16-12	1 1/2	2.80	71.1	5.67	144.0	3.45	87.6

## Male JIC 37° Flare

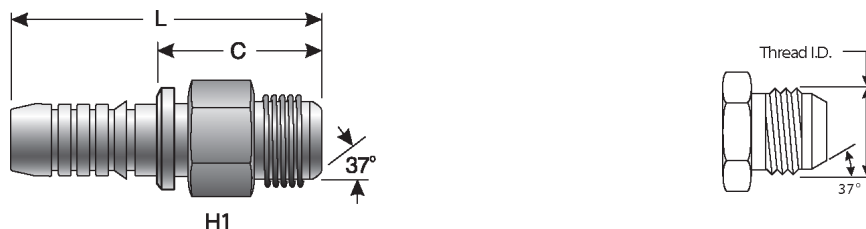

Part No.	Descr.	Prod. No.	⊖		H1	L		C		
			"	mm		"	mm	"	mm	
G20165-0606	6GS-6MJ	7347-22145	3/8	9.5	9/16-18	11/16	2.60	66.0	1.19	30.2
G20165-0608	6GS-8MJ	7347-22155	3/8	9.5	3/4-16	13/16	2.76	70.1	1.35	34.3
G20165-0610	6GS-10MJ	7347-22165	3/8	9.5	7/8-14	15/16	3.03	77.0	1.62	41.2
G20165-0808	8GS-8MJ	7347-22245	1/2	12.7	3/4-16	13/16	2.83	71.9	1.36	34.5
G20165-0810	8GS-10MJ	7347-22255	1/2	12.7	7/8-14	7/8	2.95	74.9	1.48	37.6
G20165-1010	10GS-10MJ	7347-22345	5/8	15.9	7/8-14	15/16	3.62	92.0	1.64	41.7
G20165-1012	10GS-12MJ	7347-22355	5/8	15.9	1 1/16-12	1 1/16	3.70	94.0	1.72	43.7
G20165-1212	12GS-12MJ	7347-22445	3/4	19.1	1 1/16-12	1 1/8	3.66	93.0	1.65	41.9
G20165-1214	12GS-14MJ	7347-22455	3/4	19.1	1 3/16-12	1 1/4	3.70	94.0	1.69	42.9
G20165-1216	12GS-16MJ	7347-22465	3/4	19.1	1 5/16-12	1 5/16	3.78	96.0	1.77	45.0
G20165-1616	16GS-16MJ	7347-22555	1	25.4	1 5/16-12	1 3/8	4.09	103.9	1.86	47.2
G20165-1620	16GS-20MJ	7347-22585	1	25.4	1 5/8-12	1 3/4	4.27	108.5	2.04	51.8
G20165-2020	20GS-20MJ	7347-22645	1 1/4	31.8	1 5/8-12	1 3/4	4.92	125.0	2.12	53.9

EQUIPMENT
HOSE/CPLG. SELECTION
G8K COUPLINGS
GLOBALSPIRAL COUPLINGS
STAINLESS STEEL SPIRAL
MEGACRIMP COUPLINGS
STAINLESS STEEL BRAID
POWER CRIMP COUPLINGS
FIELD ATTACHABLE G1 & G2 COUPLINGS
FIELD ATTACHABLE C5 COUPLINGS
C14 COUPLINGS
GL COUPLINGS
GLX COUPLINGS
PCTS THERMOPLASTIC COUPLINGS
POLARSEAL COUPLINGS (ACA)
POLARSEAL II COUPLINGS (ACC)
POLARSEAL II COUPLINGS (ACB)
POWER STEERING
ADAPTERS
QUICK DISCONNECT COUPLERS
BALL VALVES
LIVE SWIVEL
ASSEMBLY FABRICATION
ACCESSORIES
EQUIPMENT AND PARTS
KITS
AIR BRAKE HOSE ASSY
BRASS



EQUIPMENT
HOSE/CPLG. SELECTION
G8K COUPLINGS
<b>GLOBALSPIRAL COUPLINGS</b>
STAINLESS STEEL SPIRAL
MEGACRIMP COUPLINGS
STAINLESS STEEL BRAID
POWER CRIMP COUPLINGS
FIELD ATTACHABLE G1 & G2 COUPLINGS
FIELD ATTACHABLE C5 COUPLINGS
C14 COUPLINGS
GL COUPLINGS
GLX COUPLINGS
PCTS THERMOPLASTIC COUPLINGS
POLARSEAL COUPLINGS (ACA)
POLARSEAL II COUPLINGS (ACC)
POLARSEAL II COUPLINGS (ACB)
POWER STEERING
ADAPTERS
QUICK DISCONNECT COUPLERS
BALL VALVES
LIVE SWIVEL
ASSEMBLY FABRICATION
ACCESSORIES
EQUIPMENT AND PARTS
KITS
AIR BRAKE HOSE ASSY
BRASS

## Female JIC 37° Flare Swivel

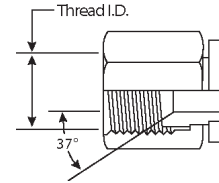
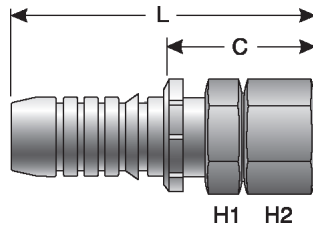

Part No.	Descr.	Prod. No.	⌀		H1	H2	L		C		
			"	mm			"	mm	"	mm	
G20170-0606	6GS-6FJX	7347-24145	3/8	9.5	9/16-18	3/4	3/4	2.72	69.1	1.31	33.3
G20170-0608	6GS-8FJX	7347-24155	3/8	9.5	3/4-16	3/4	7/8	2.80	71.1	1.39	35.3
G20170-0808	8GS-8FJX	7347-24245	1/2	12.7	3/4-16	7/8	7/8	2.83	71.9	1.36	34.5
G20170-0810	8GS-10FJX	7347-24255	1/2	12.7	7/8-14	7/8	1 1/16	2.99	76.0	1.51	38.4
G20170-0812	8GS-12FJX	7347-24265	1/2	12.7	1 1/16-12	7/8	1 1/4	3.03	77.0	1.56	39.6
G20170-1010	10GS-10FJXMM	7347-82175	5/8	15.9	7/8-14	1	1 1/16	3.68	93.5	1.70	43.2
G20170-1012	10GS-12FJX	7347-24355	5/8	15.9	1 1/16-12	1	1 1/4	3.74	95.0	1.76	44.7
G20170-1210	12GS-10FJX	7347-24435	3/4	19.1	7/8-14	1 1/16	1 1/8	3.87	98.3	1.87	47.5
G20170-1212	12GS-12FJX	7347-24445	3/4	19.1	1 1/16-12	1	1 1/4	3.87	98.3	1.86	47.2
G20170-1214	12GS-14FJX	7347-24455	3/4	19.1	1 3/16-12	1 1/8	1 3/8	4.06	103.1	2.06	52.3
G20170-1216	12GS-16FJX	7347-24465	3/4	19.1	1 5/16-12	1 1/4	1 1/2	4.02	102.1	2.01	51.1
G20170-1612	16GS-12FJX	7347-24535	1	25.4	1 1/16-12	1 3/8	1 3/8	4.25	108.0	2.00	50.8
G20170-1614	16GS-14FJX	7347-24545	1	25.4	1 3/16-12	1 3/8	1 1/2	4.25	108.0	2.01	51.1
G20170-1616	16GS-16FJX	7347-24555	1	25.4	1 5/16-12	1 1/2	1 1/2	4.30	109.2	2.07	52.6
G20170-1620	16GS-20FJX	7347-24565	1	25.4	1 5/8-12	1 1/2	2	4.53	115.1	2.31	58.7
G20170-2016	20GS-16FJX	7347-24635	1 1/4	31.8	1 5/16-12	1 3/4	1 5/8	5.08	129.0	2.28	57.9
G20170-2020	20GS-20FJX	7347-24645	1 1/4	31.8	1 5/8-12	1 7/8	2	5.29	134.4	2.56	65.0
G20170-2024	20GS-24FJX	7347-24655	1 1/4	31.8	1 7/8-12	1 7/8	2 3/8	5.39	136.9	2.59	65.8

## Female JIC 37° Flare Swivel - 30° Bent Tube

S, M and L Drops per ISO Final Draft International Standard 12151-S.

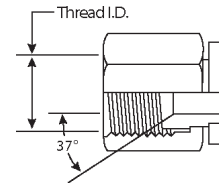
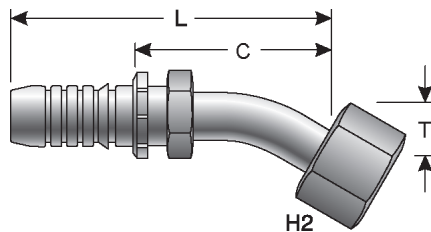

Part No.	Descr.	Prod. No.	⌀		H2	T		L		C		
			"	mm		"	mm	"	mm	"	mm	
G20172-1616	16GS-16FJX30M	7347-73055	1	25.4	1 5/16-12	1 1/2	1.06	26.9	6.02	152.9	3.80	96.5



### Female JIC 37° Flare Swivel - 45° Bent Tube

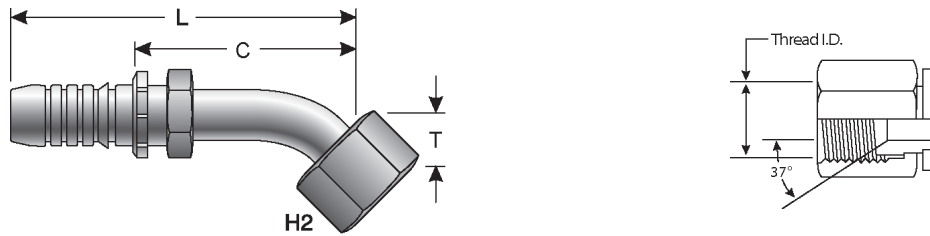

Part No.	Descr.	Prod. No.	⊖		H2	T		L		C		
			"	mm		"	mm	"	mm	"	mm	
G20174-0606	6GS-6FJX45S	7347-25145	3/8	9.5	9/16-18	3/4	.43	11.0	3.23	82.0	1.82	46.2
G20174-0608	6GS-8FJX45S	7347-25155	3/8	9.5	3/4-16	7/8	.59	15.0	3.66	93.0	2.25	57.2
G20174-0808	8GS-8FJX45S	7347-25245	1/2	12.7	3/4-16	7/8	.59	15.0	3.70	94.0	2.22	56.4
G20174-0810	8GS-10FJX45S	7347-25255	1/2	12.7	7/8-14	1 1/16	.63	16.0	3.58	90.9	2.11	53.6
G20175-1010	10GS-10FJXMM45-018	7347-83275	5/8	15.9	7/8-14	1 1/16	.71	18.0	4.45	113.0	2.48	63.0
G20174-1012	10GS-12FJX45S	7347-25355	5/8	15.9	1 1/16-12	1 1/4	.83	21.1	4.80	121.9	2.82	71.6
G20174-1212	12GS-12FJX45S	7347-25445	3/4	19.1	1 1/16-12	1 1/4	.83	21.1	5.12	130.1	3.11	79.0
G20174-1216	12GS-16FJX45S	7347-25465	3/4	19.1	1 5/16-12	1 1/2	.94	23.9	5.39	136.9	3.39	86.1
G20174-1616	16GS-16FJX45S	7347-25555	1	25.4	1 5/16-12	1 1/2	.94	23.9	5.98	151.9	3.77	95.8
G20175-1616	16GS-16FJX45M	7347-26555	1	25.4	1 5/16-12	1 1/2	1.50	38.1	6.30	160.0	4.07	103.4
G20174-1620	16GS-20FJX45S	7347-25565	1	25.4	1 5/8-12	2	.98	24.9	6.46	164.1	4.23	107.4
G20175-2020	20GS-20FJX45-038	7347-76175	1 1/4	31.8	1 5/8-12	2	1.50	38.1	7.09	180.1	4.29	109.0

### Female JIC 37° Flare Swivel - 60° Bent Tube

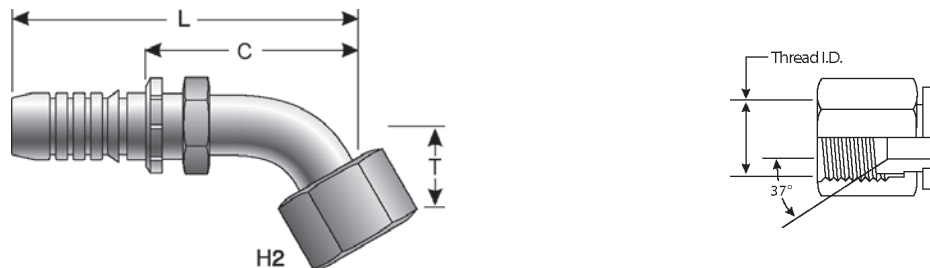

Part No.	Descr.	Prod. No.	⊖		H2	T		L		C		
			"	mm		"	mm	"	mm	"	mm	
G20177-1212	12GS-12FJX60-043	7347-76795	3/4	19.1	1 1/16-12	1 1/4	1.69	42.9	5.59	142.0	3.58	90.9

EQUIPMENT
HOSE/CPLG. SELECTION
G8K COUPLINGS
GLOBALSPIRAL COUPLINGS
STAINLESS STEEL SPIRAL
MEGACRIMP COUPLINGS
STAINLESS STEEL BRAID
POWER CRIMP COUPLINGS
FIELD ATTACHABLE G1 & G2 COUPLINGS
FIELD ATTACHABLE C5 COUPLINGS
C14 COUPLINGS
GL COUPLINGS
GLX COUPLINGS
PCTS THERMOPLASTIC COUPLINGS
POLARSEAL COUPLINGS (ACA)
POLARSEAL II COUPLINGS (ACC)
POLARSEAL II COUPLINGS (ACB)
POWER STEERING
ADAPTERS
QUICK DISCONNECT COUPLERS
BALL VALVES
LIVE SWIVEL
ASSEMBLY FABRICATION
ACCESSORIES
EQUIPMENT AND PARTS
KITS
AIR BRAKE HOSE ASSY
BRASS





## Female JIC 37° Flare Swivel - 90° Bent Tube

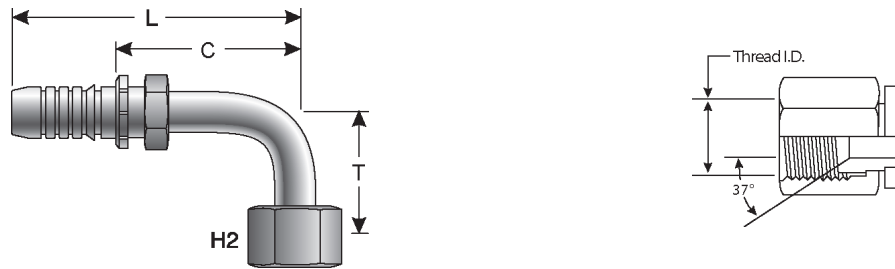

	Part No.	Descr.	Prod. No.	⌀		H2	T		L		C		
				"	mm		"	mm	"	mm	"	mm	
FIELD ATTACHABLE G1 & G2 COUPLINGS	G20179-0606	6GS-6FJX90S	7347-27145	3/8	9.5	9/16-18	3/4	.91	23.1	3.11	79.0	1.70	43.2
	G20180-0606	6GS-6FJXMM90M	7347-84045	3/8	9.5	9/16-18	3/4	1.50	38.1	3.11	79.0	1.70	43.2
	G20181-0606	6GS-6FJX90L	7347-29145	3/8	9.5	9/16-18	3/4	2.13	54.1	3.39	86.1	1.98	50.3
FIELD ATTACHABLE C5 COUPLINGS	G20180-0608	6GS-8FJX90M	7347-28155	3/8	9.5	3/4-16	7/8	1.61	40.9	3.58	90.9	2.17	55.1
	G20182-0608	6GS-8FJX90-083	7347-76785	3/8	9.5	3/4-16	7/8	3.27	83.1	3.58	90.9	2.17	55.1
	G20179-0808	8GS-8FJX90S	7347-27245	1/2	12.7	3/4-16	7/8	1.14	29.0	3.39	86.1	1.91	48.5
C14 COUPLINGS	G20180-0808	8GS-8FJX90M	7347-28245	1/2	12.7	3/4-16	7/8	1.61	40.9	3.62	92.0	2.15	54.6
	G20181-0808	8GS-8FJX90L	7347-29245	1/2	12.7	3/4-16	7/8	2.52	64.0	3.62	92.0	2.15	54.6
	G20182-0808	8GS-8FJX90XL	7347-73065	1/2	12.7	3/4-16	7/8	4.06	103.1	3.62	92.0	2.15	54.6
GLX COUPLINGS	G20179-0810	8GS-10FJX90S	7347-27255	1/2	12.7	7/8-14	1 1/16	1.26	32.0	3.62	92.0	2.15	54.6
	G20180-0810	8GS-10FJX90M	7347-28165	1/2	12.7	7/8-14	1 1/16	1.85	47.0	3.50	88.9	2.01	51.1
	G20181-0810	8GS-10FJX90L	7347-29255	1/2	12.7	7/8-14	1 1/16	3.27	83.1	3.74	95.0	2.26	57.4
PCTS THERMOPLASTIC COUPLINGS	G20179-0812	8GS-12FJX90S	7347-27265	1/2	12.7	1 1/16-12	1 1/4	1.89	48.0	4.37	111.0	2.89	73.4
	G20179-1010	10GS-10FJXMM90-036	7347-84275	5/8	15.9	7/8-14	1 1/16	1.42	36.1	4.37	111.0	2.40	61.0
	G20180-1010	10GS-10FJXMM90M	7347-84285	5/8	15.9	7/8-14	1 1/16	1.85	47.0	4.21	106.9	2.23	56.6
POLARSEAL COUPLINGS (ACA)	G20180-1012	10GS-12FJX90M	7347-28355	5/8	15.9	1 1/16-12	1 1/4	2.28	57.9	4.76	120.9	2.78	70.6
	G20179-1212	12GS-12FJX90S	7347-27445	3/4	19.1	1 1/16-12	1 1/4	1.89	48.0	4.45	113.0	2.68	68.1
	G20180-1212	12GS-12FJX90M	7347-28445	3/4	19.1	1 1/16-12	1 1/4	2.28	57.9	4.45	113.0	2.44	62.0
POLARSEAL II COUPLINGS (ACC)	G20181-1212	12GS-12FJX90L	7347-29445	3/4	19.1	1 1/16-12	1 1/4	3.78	96.0	4.45	113.0	2.44	62.0
	G20180-1214	12GS-14FJX90-060	7347-28455	3/4	19.1	1 3/16-12	1 3/8	2.36	59.9	5.55	141.0	3.54	89.9
	G20179-1216	12GS-16FJX90S	7347-27465	3/4	19.1	1 5/16-12	1 1/2	2.20	55.9	5.31	134.9	3.31	84.1
POLARSEAL II COUPLINGS (ACB)	G20180-1216	12GS-16FJX90M	7347-28465	3/4	19.1	1 5/16-12	1 1/2	2.80	71.1	5.31	134.9	3.31	84.1
	G20181-1216	12GS-16FJX90L	7347-29465	3/4	19.1	1 5/16-12	1 1/2	4.49	114.1	5.32	135.1	3.31	84.1
	G20179-1616	16GS-16FJX90S	7347-27555	1	25.4	1 5/16-12	1 1/2	2.20	55.9	5.67	144.0	3.45	87.6
POWER STEERING	G20180-1616	16GS-16FJX90M	7347-28555	1	25.4	1 5/16-12	1 1/2	2.80	71.1	5.67	144.0	3.45	87.6
	G20181-1616	16GS-16FJX90L	7347-29555	1	25.4	1 5/16-12	1 1/2	4.33	110.0	5.67	144.0	3.45	87.6
	G20181-1620	16GS-20FJX90L	7347-29565	1	25.4	1 5/8-12	2	5.08	129.0	6.06	153.9	3.84	97.5
ADAPTERS	G20179-2020	20GS-20FJX90S	7347-27645	1 1/4	31.8	1 5/8-12	2	2.52	64.0	6.85	174.0	4.05	102.9
	G20180-2020	20GS-20FJX90M	7347-28645	1 1/4	31.8	1 5/8-12	2	3.07	78.0	6.85	174.0	4.05	102.9
	G20181-2020	20GS-20FJX90L	7347-29645	1 1/4	31.8	1 5/8-12	2	5.08	129.0	6.85	174.0	4.05	102.9
QUICK DISCONNECT COUPLERS	G20180-2024	20GS-24FJX90M	7347-28655	1 1/4	31.8	1 7/8-12	2 3/8	3.39	86.1	7.32	185.9	4.52	114.8
BALL VALVES													
LIVE SWIVEL													
ASSEMBLY FABRICATION													
ACCESSORIES													
EQUIPMENT AND PARTS													
KITS													
AIR BRAKE HOSE ASSY													
BRASS													



## Male Flat-Face O-Ring

Includes Peroxide-cured O-Ring.  
Metric Hex per ISO Draft International Standard 12151-1.  
Utilizes SAE J1453 Captive O-Ring Groove for Improved O-Ring Retention.

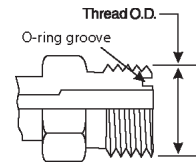
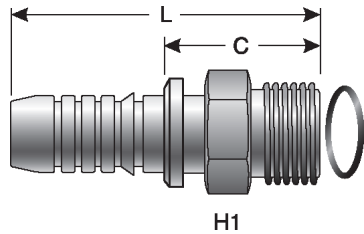

Part No.	Descr.	Prod. No.	⊖		🌀	H1	L		C	
			"	mm			"	mm	"	mm
G20225-0606	6GS-6MFFOR	7347-23865	3/8	9.5	11/16-16	19	2.52	64.0	1.11	28.2
G20225-0808	8GS-8MFFOR	7347-23825	1/2	12.7	13/16-16	22	2.68	68.1	1.20	30.5
G20225-0810	8GS-10MFFOR	7347-23895	1/2	12.7	1-14	27	2.91	73.9	1.44	36.6
G20225-1010	10GS-10MFFOR	7347-23875	5/8	15.9	1-14	27	3.42	86.9	1.44	36.6
G20225-1012	10GS-12MFFOR	7347-23885	5/8	15.9	1 3/16-12	32	3.50	88.9	1.52	38.6
G20225-1212	12GS-12MFFOR	7347-23835	3/4	19.1	1 3/16-12	32	3.50	88.9	1.50	38.1
G20225-1216	12GS-16MFFOR	7347-23845	3/4	19.1	1 7/16-12	41	3.74	95.0	1.73	43.9
G20225-1616	16GS-16MFFOR	7347-23815	1	25.4	1 7/16-12	41	4.02	102.1	1.78	45.2
G20225-1620	16GS-20MFFOR	7347-23925	1	25.4	1 11/16-12	50	4.17	106.0	1.78	45.2
G20225-2020	20GS-20MFFOR	7347-23855	1 1/4	31.8	1 11/16-12	50	4.72	119.9	1.93	49.0

## Female Flat-Face O-Ring Swivel

Metric Hex per ISO Draft International Standard 12151-1.  
SAE J1453 O-Ring Face Seal.

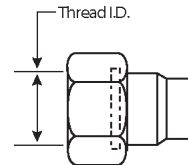
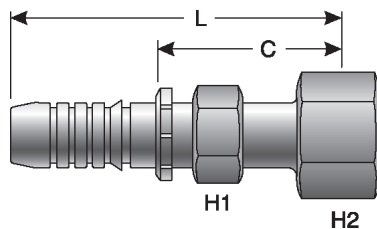

Part No.	Descr.	Prod. No.	⊖		🌀	H1	H2	L		C	
			"	mm				"	mm	"	mm
G20230-0606	6GS-6FFORX	7347-30145	3/8	9.5	11/16-16	22	22	2.72	69.1	1.31	33.3
G20230-0608	6GS-8FFORX	7347-30155	3/8	9.5	13/16-16	22	24	2.83	71.9	1.43	36.3
G20230-0808	8GS-8FFORX	7347-30245	1/2	12.7	13/16-16	24	24	2.87	72.9	1.40	35.6
G20230-0810	8GS-10FFORX	7347-30255	1/2	12.7	1-14	24	30	3.07	78.0	1.59	40.4
G20230-0812	8GS-12FFORX	7347-30265	1/2	12.7	1 3/16-12	24	36	3.11	79.0	1.63	41.4
G20230-1010	10GS-10FFORX	7347-30345	5/8	15.9	1-14	30	30	3.70	94.0	1.72	43.7
G20230-1012	10GS-12FFORX	7347-30355	5/8	15.9	1 3/16-12	30	36	3.74	95.0	1.76	44.7
G20230-1210	12GS-10FFORX	7347-30435	3/4	19.1	1-14	32	30	3.82	97.0	1.81	46.0
G20230-1212	12GS-12FFORX	7347-30445	3/4	19.1	1 3/16-12	32	36	1.95	49.5	1.89	48.1
G20230-1216	12GS-16FFORX	7347-30465	3/4	19.1	1 7/16-12	32	41	4.06	103.1	2.05	52.1
G20230-1220	12GS-20FFORX	7347-30475	3/4	19.1	1 11/16-12	32	50	3.91	99.3	1.90	48.3
G20230-1612	16GS-12FFORX	7347-30535	1	25.4	1 3/16-12	36	36	5.15	130.8	2.92	74.2
G20230-1616	16GS-16FFORX	7347-30555	1	25.4	1 7/16-12	41	41	4.36	110.7	2.14	54.4
G20230-1620	16GS-20FFORX	7347-30565	1	25.4	1 11/16-12	41	50	4.36	110.7	2.14	54.4

EQUIPMENT
HOSE/CPLG. SELECTION
G8K COUPLINGS
GLOBALSPIRAL COUPLINGS
STAINLESS STEEL SPIRAL
MEGACRIMP COUPLINGS
STAINLESS STEEL BRAID
POWER CRIMP COUPLINGS
FIELD ATTACHABLE G1 & G2 COUPLINGS
FIELD ATTACHABLE C5 COUPLINGS
C14 COUPLINGS
GL COUPLINGS
GLX COUPLINGS
PCTS THERMOPLASTIC COUPLINGS
POLARSEAL COUPLINGS (ACA)
POLARSEAL II COUPLINGS (ACC)
POLARSEAL II COUPLINGS (ACB)
POWER STEERING
ADAPTERS
QUICK DISCONNECT COUPLERS
BALL VALVES
LIVE SWIVEL
ASSEMBLY FABRICATION
ACCESSORIES
EQUIPMENT AND PARTS
KITS
AIR BRAKE HOSE ASSY
BRASS



EQUIPMENT
HOSE/CPLG. SELECTION
G8K COUPLINGS
<b>GLOBALSPIRAL COUPLINGS</b>
STAINLESS STEEL SPIRAL
MEGACRIMP COUPLINGS
STAINLESS STEEL BRAID
POWER CRIMP COUPLINGS
FIELD ATTACHABLE G1 & G2 COUPLINGS
FIELD ATTACHABLE C5 COUPLINGS
C14 COUPLINGS
GL COUPLINGS
GLX COUPLINGS
PCTS THERMOPLASTIC COUPLINGS
POLARSEAL COUPLINGS (ACA)
POLARSEAL II COUPLINGS (ACC)
POLARSEAL II COUPLINGS (ACB)
POWER STEERING
ADAPTERS
QUICK DISCONNECT COUPLERS
BALL VALVES
LIVE SWIVEL
ASSEMBLY FABRICATION
ACCESSORIES
EQUIPMENT AND PARTS
KITS
AIR BRAKE HOSE ASSY
BRASS

### Female Flat-Face O-Ring Swivel - Continued

Part No.	Descr.	Prod. No.	⊖		H1	H2	L		C		
			"	mm			"	mm	"	mm	"
G20230-2020	20GS-20FFORX	7347-30645	1 1/4	31.8	1 11/16-12	50	50	5.04	128.0	2.24	56.9
G20230-2024	20GS-24FFORX	7347-30655	1 1/4	31.8	2-12	50	60	5.12	130.1	2.32	58.9

### Female Flat-Face O-Ring Swivel - 22 1/2° Bent Tube

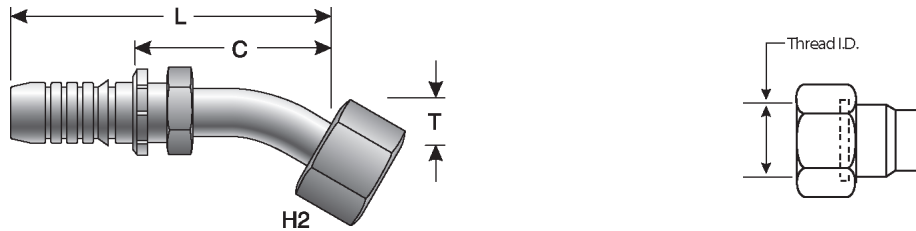

Part No.	Descr.	Prod. No.	⊖		H2	T		L		C		
			"	mm		"	mm	"	mm	"	mm	
G20232-1616	16GS-16FFORX22-011	7347-78615	1	25.4	1 7/16-12	41	.43	11.0	5.87	149.1	3.68	93.5

### Female Flat-Face O-Ring Swivel - 30° Bent Tube

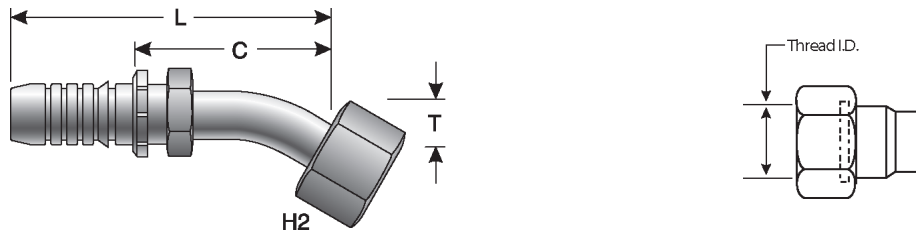

Part No.	Descr.	Prod. No.	⊖		H2	T		L		C		
			"	mm		"	mm	"	mm	"	mm	
G20233-1616	16GS-16FFORX30-14	7347-76345	1	25.4	1 7/16-12	41	.55	14.0	5.87	149.1	3.64	92.5



## Female Flat-Face O-Ring Swivel - 45° Bent Tube

Metric Hex per ISO Draft International Standard 12151-1.  
SAE J1453 O-Ring Face Seal.

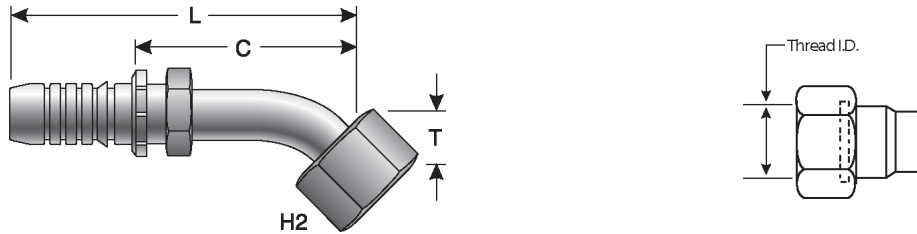

Part No.	Descr.	Prod. No.	⌀		H2	T		L		C		
			"	mm		"	mm	"	mm	"	mm	
G20234-0606	6GS-6FFORX45S	7347-31145	3/8	9.5	11/16-16	22	.43	11.0	3.23	82.0	1.82	46.2
G20234-0608	6GS-8FFORX45S	7347-31155	3/8	9.5	13/16-16	24	.59	15.0	3.66	93.0	2.25	57.2
G20234-0808	8GS-8FFORX45S	7347-31245	1/2	12.7	13/16-16	24	.59	15.0	3.70	94.0	2.22	56.4
G20234-0810	8GS-10FFORX45S	7347-31255	1/2	12.7	1-14	24	.63	16.0	3.90	99.1	2.42	61.5
G20234-0812	8GS-12FFORX45S	7347-31265	1/2	12.7	1 3/16-12	24	.83	21.1	4.53	115.1	3.05	77.5
G20234-1010	10GS-10FFORX45S	7347-31345	5/8	15.9	1-14	30	.63	16.0	4.37	111.0	2.39	60.7
G20234-1212	12GS-12FFORX45S	7347-31445	3/4	19.1	1 3/16-12	36	.83	21.1	4.92	125.0	2.91	73.9
G20234-1216	12GS-16FFORX45S	7347-31465	3/4	19.1	1 7/16-12	24	.94	23.9	5.39	136.9	3.39	86.1
G20234-1616	16GS-16FFORX45S	7347-31555	1	25.4	1 7/16-12	24	.94	23.9	5.67	144.0	3.46	87.9
G20234-1620	16GS-20FFORX45S	7347-31565	1	25.4	1 11/16-12	50	.98	24.9	6.46	164.1	4.24	107.7
G20234-2020	20GS-20FFORX45-032	7347-76045	1 1/4	31.8	1 11/16-12	50	1.26	32.0	7.09	180.1	4.29	109.0

## Female Flat-Face O-Ring Swivel - 90° Bent Tube

Metric Hex per ISO Draft International Standard 12151-1.  
SAE J1453 O-Ring Face Seal.

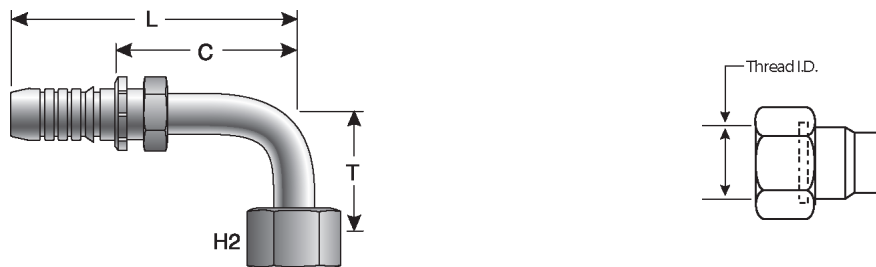

Part No.	Descr.	Prod. No.	⌀		H2	T		L		C		
			"	mm		"	mm	"	mm	"	mm	
G20239-0606	6GS-6FFORX90S	7347-32145	3/8	9.5	11/16-16	22	.91	23.1	3.07	78.0	1.66	42.2
G20241-0606	6GS-6FFORX90L	7347-34145	3/8	9.5	11/16-16	22	2.13	54.1	3.35	85.1	1.94	49.3
G20240-0608	6GS-8FFORX90M	7347-33155	3/8	9.5	13/16-16	24	1.61	40.9	3.35	85.1	1.94	49.3
G20239-0808	8GS-8FFORX90S	7347-32245	1/2	12.7	13/16-16	24	1.14	29.0	3.39	86.1	1.91	48.5
G20240-0808	8GS-8FFORX90M	7347-33245	1/2	12.7	13/16-16	24	1.61	40.9	3.39	86.1	1.91	48.5
G20241-0808	8GS-8FFORX90-083	7347-73845	1/2	12.7	13/16-16	24	3.27	83.1	3.39	86.1	1.91	48.5
G20239-0810	8GS-10FFORX90S	7347-32255	1/2	12.7	1-14	30	1.26	32.0	3.98	101.1	2.50	63.5
G20240-0810	8GS-10FFORX90M	7347-33255	1/2	12.7	1-14	30	1.85	47.0	3.98	101.1	2.50	63.5
G20241-0810	8GS-10FFORX90L	7347-34255	1/2	12.7	1-14	30	2.76	70.1	3.98	101.1	2.50	63.5
G20239-0812	8GS-12FFORX90S	7347-32265	1/2	12.7	1 3/16-12	36	1.89	48.0	4.21	106.9	2.74	69.6
G20239-1010	10GS-10FFORX90S	7347-32345	5/8	15.9	1-14	30	1.26	32.0	4.20	106.7	2.22	56.4
G20240-1010	10GS-10FFORX90M	7347-33345	5/8	15.9	1-14	30	1.85	47.0	4.21	106.9	2.20	55.9
G20241-1010	10GS-10FFORX90L	7347-34345	5/8	15.9	1-14	30	2.76	70.1	4.45	113.0	2.44	62.0

EQUIPMENT
HOSE/CPLG. SELECTION
G8K COUPLINGS
GLOBALSPIRAL COUPLINGS
STAINLESS STEEL SPIRAL
MEGACRIMP COUPLINGS
STAINLESS STEEL BRAID
POWER CRIMP COUPLINGS
FIELD ATTACHABLE G1 & G2 COUPLINGS
FIELD ATTACHABLE C5 COUPLINGS
C14 COUPLINGS
GL COUPLINGS
GLX COUPLINGS
PCTS THERMOPLASTIC COUPLINGS
POLARSEAL COUPLINGS (ACA)
POLARSEAL II COUPLINGS (ACC)
POLARSEAL II COUPLINGS (ACB)
POWER STEERING
ADAPTERS
QUICK DISCONNECT COUPLERS
BALL VALVES
LIVE SWIVEL
ASSEMBLY FABRICATION
ACCESSORIES
EQUIPMENT AND PARTS
KITS
AIR BRAKE HOSE ASSY
BRASS



EQUIPMENT
HOSE/CPLG. SELECTION
G8K COUPLINGS
GLOBALSPIRAL COUPLINGS
STAINLESS STEEL SPIRAL
MEGACRIMP COUPLINGS
STAINLESS STEEL BRAID
POWER CRIMP COUPLINGS
FIELD ATTACHABLE G1 & G2 COUPLINGS
FIELD ATTACHABLE C5 COUPLINGS
C14 COUPLINGS
GL COUPLINGS
GLX COUPLINGS
PCTS THERMOPLASTIC COUPLINGS
POLARSEAL COUPLINGS (ACA)
POLARSEAL II COUPLINGS (ACC)
POLARSEAL II COUPLINGS (ACB)
POWER STEERING
ADAPTERS
QUICK DISCONNECT COUPLERS
BALL VALVES
LIVE SWIVEL
ASSEMBLY FABRICATION
ACCESSORIES
EQUIPMENT AND PARTS
KITS
AIR BRAKE HOSE ASSY
BRASS

### Female Flat-Face O-Ring Swivel - 90° Bent Tube - Continued

Part No.	Descr.	Prod. No.	⊖		H2	T		L		C		
			"	mm		"	mm	"	mm	"	mm	
G20239-1012	10GS-12FFORX90S	7347-32355	5/8	15.9	1 3/16-12	36	1.26	32.0	4.21	106.9	2.74	69.6
G20239-1210	12GS-10FFORX90S	7347-32435	3/4	19.1	1-14	30	1.26	32.0	4.37	111.0	2.36	59.9
G20239-1212	12GS-12FFORX90S	7347-32445	3/4	19.1	1 3/16-12	36	1.89	48.0	5.04	128.0	3.03	77.0
G20240-1212	12GS-12FFORX90M	7347-33445	3/4	19.1	1 3/16-12	36	2.28	57.9	5.04	128.0	3.03	77.0
G20241-1212	12GS-12FFORX90L	7347-34445	3/4	19.1	1 3/16-12	36	3.78	96.0	5.04	128.0	3.03	77.0
G20239-1216	12GS-16FFORX90S	7347-32465	3/4	19.1	1 7/16-12	41	2.20	55.9	5.39	136.9	3.39	86.1
G20240-1216	12GS-16FFORX90M	7347-33465	3/4	19.1	1 7/16-12	41	2.80	71.1	5.39	136.9	3.39	86.1
G20241-1216	12GS-16FFORX90L	7347-34465	3/4	19.1	1 7/16-12	41	4.49	114.1	5.39	136.9	3.39	86.1
G20239-1616	16GS-16FFORX90S	7347-32555	1	25.4	1 7/16-12	41	2.20	55.9	5.67	144.0	3.45	87.6
G20240-1616	16GS-16FFORX90M	7347-33555	1	25.4	1 7/16-12	41	2.80	71.1	5.67	144.0	3.45	87.6
G20241-1616	16GS-16FFORX90L	7347-34555	1	25.4	1 7/16-12	41	4.49	114.1	5.67	144.0	3.45	87.6
G20239-1620	16GS-20FFORX90S	7347-32565	1	25.4	1 11/16-12	50	2.52	64.0	6.06	153.9	3.84	97.5
G20240-1620	16GS-20FFORX90M	7347-33565	1	25.4	1 11/16-12	50	3.07	78.0	6.05	153.7	3.83	97.3
G20241-1620	16GS-20FFORX90L	7347-34565	1	25.4	1 11/16-12	50	5.08	129.0	6.05	153.7	3.83	97.3
G20239-2020	20GS-20FFORX90S	7347-32645	1 1/4	31.8	1 11/16-12	50	2.52	64.0	6.77	172.0	3.97	100.8
G20240-2020	20GS-20FFORX90M	7347-33645	1 1/4	31.8	1 11/16-12	50	3.07	78.0	6.77	172.0	3.97	100.8
G20241-2020	20GS-20FFORX90L	7347-34645	1 1/4	31.8	1 11/16-12	50	5.08	129.0	6.77	172.0	3.97	100.8
G20239-2024	20GS-24FFORX90-064	7347-76985	1 1/4	31.8	2-12	60	2.52	64.0	6.77	172.0	3.97	100.8

### Female Flat-Face O-Ring Swivel - 135° Bent Tube

Metric Hex per ISO Draft International Standard 12151-1.  
SAE J1453 O-Ring Face Seal.

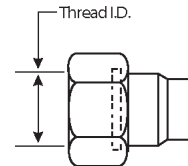
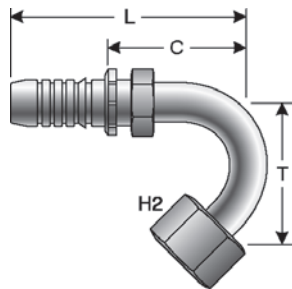

Part No.	Descr.	Prod. No.	⊖		H2	T		L		C		
			"	mm		"	mm	"	mm	"	mm	
G20248-1216	12GS-16FFORX135	7347-73795	3/4	19.1	1 7/16-12	24	2.99	76.0	3.39	86.1	1.48	37.6



### Code 61 O-Ring Flange

-8FL, -12FL, -16FL Max. W.P. 5,000 psi; -20FL Max. W.P. 4,000 psi.  
See Accessories for O-Rings.

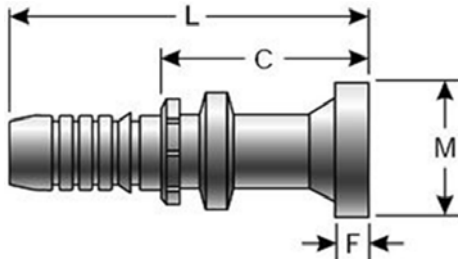

Part No.	Descr.	Prod. No.	⊖		M		L		C		F	
			"	mm	"	mm	"	mm	"	mm	"	mm
G20300-0608	6GS-8FL	7347-41155	3/8	9.5	1.19	30.2	3.54	89.9	2.13	54.1	.27	6.9
G20300-0808	8GS-8FL	7347-41245	1/2	12.7	1.19	30.2	3.66	93.0	2.19	55.6	.27	6.9
G20300-0812	8GS-12FL	7347-41265	1/2	12.7	1.50	38.1	3.86	98.1	2.38	60.5	.27	6.9
G20300-0816	8GS-16FL	7347-41285	1/2	12.7	1.75	44.5	2.84	72.1	1.37	34.8	.32	8.1
G20300-1012	10GS-12FL	7347-41355	5/8	15.9	1.50	38.1	4.29	109.0	2.31	58.7	.27	6.9
G20300-1208	12GS-8FL	7347-41425	3/4	19.1	1.19	30.2	4.41	112.0	2.40	61.0	.27	6.9
G20300-1212	12GS-12FL	7347-41445	3/4	19.1	1.50	38.1	4.37	111.0	2.36	59.9	.27	6.9
G20300-1216	12GS-16FL	7347-41465	3/4	19.1	1.75	44.5	4.37	111.0	2.36	59.9	.32	8.1
G20300-1220	12GS-20FL	7347-41475	3/4	19.1	2.00	50.8	4.37	111.0	2.36	59.9	.32	8.1
G20300-1612	16GS-12FL	7347-41535	1	25.4	1.50	38.1	4.65	118.1	2.40	61.0	.27	6.9
G20300-1616	16GS-16FL	7347-41555	1	25.4	1.75	44.5	4.92	125.0	2.70	68.6	.32	8.1
G20300-1620	16GS-20FL	7347-41565	1	25.4	2.00	50.8	4.92	125.0	2.69	68.3	.32	8.1
G20300-1624	16GS-24FL	7347-41575	1	25.4	2.38	60.5	4.92	125.0	1.90	48.3	.32	8.1
G20300-2016	20GS-16FL	7347-41635	1 1/4	31.8	1.75	44.5	5.35	135.9	2.55	64.8	.32	8.1
G20300-2020	20GS-20FL	7347-41645	1 1/4	31.8	2.00	50.8	5.75	146.1	2.95	74.9	.32	8.1
G20300-2024	20GS-24FL	7347-41655	1 1/4	31.8	2.38	60.5	6.30	160.0	3.50	88.9	.32	8.1
G20300-2032	20GS-32FL	7347-41665	1 1/4	31.8	2.81	71.4	5.71	145.0	2.91	73.9	.38	9.7

### Code 61 Komatsu Style O-Ring Flange

See Accessories for O-Rings.

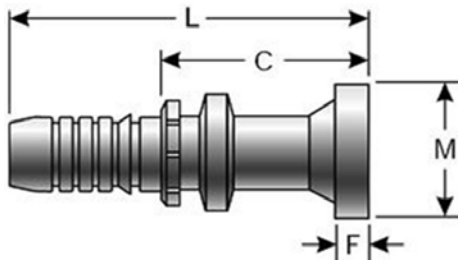

Part No.	Descr.	Prod. No.	⊖		M		L		C		F	
			"	mm	"	mm	"	mm	"	mm	"	mm
G20300-0810	8GS-10FLK	7347-55255	1/2	12.7	1.35	34.3	3.21	81.5	1.74	44.2	.27	6.9
G20300-1010	10GS-10FLK	7347-73335	5/8	15.9	1.35	34.3	4.49	114.1	2.51	63.8	.27	6.9
G20300-1210	12GS-10FLK	7347-73375	3/4	19.1	1.35	34.3	4.33	110.0	2.32	58.9	.27	6.9

EQUIPMENT
HOSE/CPLG. SELECTION
G8K COUPLINGS
GLOBALSPIRAL COUPLINGS
STAINLESS STEEL SPIRAL
MEGACRIMP COUPLINGS
STAINLESS STEEL BRAID
POWER CRIMP COUPLINGS
FIELD ATTACHABLE G1 & G2 COUPLINGS
FIELD ATTACHABLE C5 COUPLINGS
C14 COUPLINGS
GL COUPLINGS
GLX COUPLINGS
PCTS THERMOPLASTIC COUPLINGS
POLARSEAL COUPLINGS (ACA)
POLARSEAL II COUPLINGS (ACC)
POLARSEAL II COUPLINGS (ACB)
POWER STEERING
ADAPTERS
QUICK DISCONNECT COUPLERS
BALL VALVES
LIVE SWIVEL
ASSEMBLY FABRICATION
ACCESSORIES
EQUIPMENT AND PARTS
KITS
AIR BRAKE HOSE ASSY
BRASS





EQUIPMENT
HOSE/CPLG. SELECTION
G8K COUPLINGS
<b>GLOBALSPIRAL COUPLINGS</b>
STAINLESS STEEL SPIRAL
MEGACRIMP COUPLINGS
STAINLESS STEEL BRAID
POWER CRIMP COUPLINGS
FIELD ATTACHABLE G1 & G2 COUPLINGS
FIELD ATTACHABLE C5 COUPLINGS
C14 COUPLINGS
GL COUPLINGS
GLX COUPLINGS
PCTS THERMOPLASTIC COUPLINGS
POLARSEAL COUPLINGS (ACA)
POLARSEAL II COUPLINGS (ACC)
POLARSEAL II COUPLINGS (ACB)
POWER STEERING
ADAPTERS
QUICK DISCONNECT COUPLERS
BALL VALVES
LIVE SWIVEL
ASSEMBLY FABRICATION
ACCESSORIES
EQUIPMENT AND PARTS
KITS
AIR BRAKE HOSE ASSY
BRASS

### Code 61 O-Ring Flange Long Neck

-8FL, -12FL, -16FL Max. W.P. 5,000 psi; -20FL Max. W.P. 4,000 psi.  
See Accessories for O-Rings.

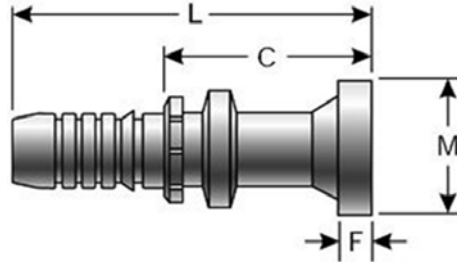

Part No.	Descr.	Prod. No.	⊖		M		L		C		F	
			"	mm	"	mm	"	mm	"	mm	"	mm
G20301-1212	12GS-12FLL	7347-41455	3/4	19.1	1.50	38.1	5.20	132.1	3.19	81.0	.27	6.9
G20301-1616	16GS-16FLL	7347-41545	1	25.4	1.75	44.5	5.63	143.0	3.41	86.6	.32	8.1
G20301-2020	20GS-20FLL	7347-41675	1 1/4	31.8	2.00	50.8	6.26	159.0	3.46	87.9	.32	8.1

### Code 61 O-Ring Flange - 22 1/2° Bent Tube

-8FL, -12FL, -16FL Max. W.P. 5,000 psi; -20FL Max. W.P. 4,000 psi.  
S, M and L Drops per ISO Final Draft International Standard 12151-3.  
See Accessories for O-Rings.

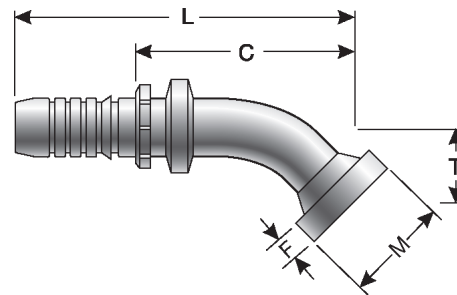

Part No.	Descr.	Prod. No.	⊖		M		T		L		C		F	
			"	mm	"	mm	"	mm	"	mm	"	mm	"	mm
G20302-0808	8GS-8FL22M	7347-42245	1/2	12.7	1.19	30.2	.35	8.9	3.78	96.0	2.30	58.4	.27	6.9
G20302-1212	12GS-12FL22M	7347-42445	3/4	19.1	1.50	38.1	.43	11.0	5.16	131.1	3.15	80.0	.27	6.9
G20302-1216	12GS-16FL22M	7347-42465	3/4	19.1	1.75	44.5	.55	14.0	5.24	133.1	3.23	82.0	.32	8.1
G20302-1616	16GS-16FL22M	7347-42555	1	25.4	1.75	44.5	.55	14.0	6.10	154.9	3.87	98.3	.32	8.1
G20302-1620	16GS-20FL22M	7347-42565	1	25.4	2.00	50.8	.59	15.0	6.61	167.9	4.37	111.0	.32	8.1
G20302-2020	20GS-20FL22M	7347-42645	1 1/4	31.8	2.00	50.8	.59	15.0	7.01	178.1	4.21	106.9	.32	8.1
G20302-2024	20GS-24FL22M	7347-42655	1 1/4	31.8	2.38	60.5	.71	18.0	7.32	185.9	4.52	114.8	.32	8.1



### Code 61 O-Ring Flange - 30° Bent Tube

-8FL, -12FL, -16FL Max. W.P. 5,000 psi; -20FL Max. W.P. 4,000 psi.  
S, M and L Drops per ISO Final Draft International Standard 12151-3.  
See Accessories for O-Rings.

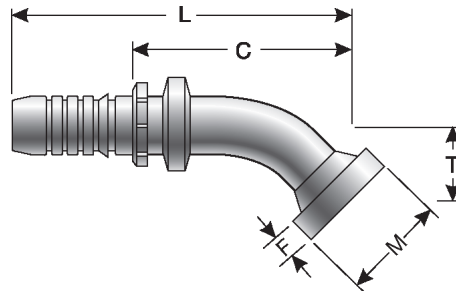

Part No.	Descr.	Prod. No.	⌀		M		T		L		C		F	
			"	mm	"	mm	"	mm	"	mm	"	mm	"	mm
G20304-0812	8GS-12FL30M	7347-43265	1/2	12.7	1.50	38.1	.63	16.0	3.94	100.1	2.46	62.5	.27	6.9
G20304-1212	12GS-12FL30M	7347-43445	3/4	19.1	1.50	38.1	.63	16.0	5.08	129.0	3.07	78.0	.27	6.9
G20304-1216	12GS-16FL30M	7347-43465	3/4	19.1	1.75	44.5	.75	19.1	4.76	120.9	2.76	70.1	.32	8.1
G20304-1616	16GS-16FL30M	7347-43555	1	25.4	1.75	44.5	.75	19.1	6.02	152.9	3.80	96.5	.32	8.1
G20304-1620	16GS-20FL30M	7347-43565	1	25.4	2.00	50.8	.87	22.1	6.54	166.1	4.29	109.0	.32	8.1
G20304-2020	20GS-20FL30M	7347-43645	1 1/4	31.8	2.00	50.8	.87	22.1	6.93	176.0	4.13	104.9	.32	8.1
G20304-2024	20GS-24FL30M	7347-43655	1 1/4	31.8	2.38	60.5	1.18	30.0	7.17	182.1	4.37	111.0	.32	8.1

### Code 61 O-Ring Flange - 45° Bent Tube

-8FL, -12FL, -16FL Max. W.P. 5,000 psi; -20FL Max. W.P. 4,000 psi.  
S, M and L Drops per ISO Final Draft International Standard 12151-3.  
See Accessories for O-Rings.

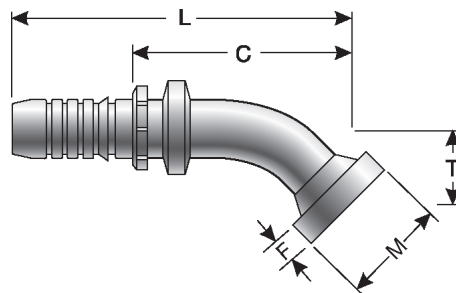

Part No.	Descr.	Prod. No.	⌀		M		T		L		C		F	
			"	mm	"	mm	"	mm	"	mm	"	mm	"	mm
G20307-0608	6GS-8FL45M	7347-44155	3/8	9.5	1.19	30.2	.75	19.1	3.66	93.0	2.25	57.2	.27	6.9
G20307-0808	8GS-8FL45M	7347-44245	1/2	12.7	1.19	30.2	.75	19.1	3.70	94.0	2.22	56.4	.27	6.9
G20307-0812	8GS-12FL45M	7347-44265	1/2	12.7	1.50	38.1	1.02	25.9	3.98	101.1	2.50	63.5	.27	6.9
G20307-1012	10GS-12FL45M	7347-44355	5/8	15.9	1.50	38.1	1.02	25.9	5.00	127.0	3.02	76.7	.27	6.9
G20307-1212	12GS-12FL45M	7347-44445	3/4	19.1	1.50	38.1	1.02	25.9	4.88	124.0	2.87	72.9	.27	6.9
G20306-1216	12GS-16FL45S	7347-73135	3/4	19.1	1.75	44.5	1.10	27.9	4.96	126.0	2.95	74.9	.32	8.1
G20307-1616	16GS-16FL45M	7347-44555	1	25.4	1.75	44.5	1.26	32.0	5.79	147.1	3.57	90.7	.32	8.1
G20307-1620	16GS-20FL45M	7347-44565	1	25.4	2.00	50.8	1.50	38.1	6.22	158.0	3.97	100.8	.32	8.1
G20307-2016	20GS-16FL45M	7347-44635	1 1/4	31.8	1.75	44.5	1.26	32.0	6.42	163.1	3.62	92.0	.32	8.1
G20306-2020	20GS-20FL45S	7347-73565	1 1/4	31.8	2.00	50.8	1.26	32.0	6.69	169.9	3.89	98.8	.32	8.1
G20306-2024	20GS-24FL45S	7347-73575	1 1/4	31.8	2.38	60.5	1.50	38.1	6.93	176.0	4.13	104.9	.32	8.1

EQUIPMENT
HOSE/CPLG. SELECTION
G8K COUPLINGS
GLOBALSPIRAL COUPLINGS
STAINLESS STEEL SPIRAL
MEGACRIMP COUPLINGS
STAINLESS STEEL BRAID
POWER CRIMP COUPLINGS
FIELD ATTACHABLE G1 & G2 COUPLINGS
FIELD ATTACHABLE C5 COUPLINGS
C14 COUPLINGS
GL COUPLINGS
GLX COUPLINGS
PCTS THERMOPLASTIC COUPLINGS
POLARSEAL COUPLINGS (ACA)
POLARSEAL II COUPLINGS (ACC)
POLARSEAL II COUPLINGS (ACB)
POWER STEERING
ADAPTERS
QUICK DISCONNECT COUPLERS
BALL VALVES
LIVE SWIVEL
ASSEMBLY FABRICATION
ACCESSORIES
EQUIPMENT AND PARTS
KITS
AIR BRAKE HOSE ASSY
BRASS



EQUIPMENT
HOSE/CPLG. SELECTION
G8K COUPLINGS
<b>GLOBALSPIRAL COUPLINGS</b>
STAINLESS STEEL SPIRAL
MEGACRIMP COUPLINGS
STAINLESS STEEL BRAID
POWER CRIMP COUPLINGS
FIELD ATTACHABLE G1 & G2 COUPLINGS
FIELD ATTACHABLE C5 COUPLINGS
C14 COUPLINGS
GL COUPLINGS
GLX COUPLINGS
PCTS THERMOPLASTIC COUPLINGS
POLARSEAL COUPLINGS (ACA)
POLARSEAL II COUPLINGS (ACC)
POLARSEAL II COUPLINGS (ACB)
POWER STEERING
ADAPTERS
QUICK DISCONNECT COUPLERS
BALL VALVES
LIVE SWIVEL
ASSEMBLY FABRICATION
ACCESSORIES
EQUIPMENT AND PARTS
KITS
AIR BRAKE HOSE ASSY
BRASS

### Code 61 Komatsu Style O-Ring Flange - 45° Bent Tube

See Accessories for O-Rings.

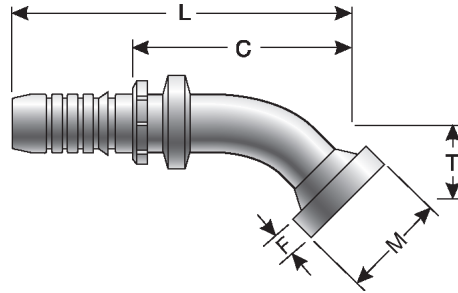

Part No.	Descr.	Prod. No.	⊖		M		T		L		C		F	
			"	mm	"	mm	"	mm	"	mm	"	mm	"	mm
G20307-1010	10GS-10FLK45-026	7347-73365	5/8	15.9	1.35	34.3	1.02	25.9	4.76	120.9	2.78	70.6	.27	6.9

### Code 61 O-Ring Flange - 60° Bent Tube

-8FL, -12FL, -16FL Max. W.P. 5,000 psi; -20FL Max. W.P. 4,000 psi.  
S, M and L Drops per ISO Final Draft International Standard 12151-3.  
See Accessories for O-Rings.

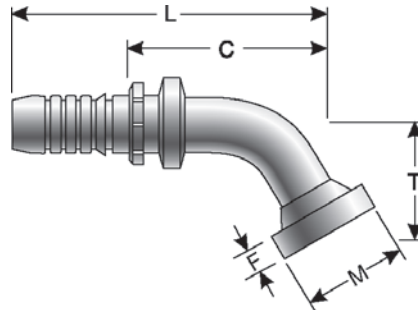

Part No.	Descr.	Prod. No.	⊖		M		T		L		C		F	
			"	mm	"	mm	"	mm	"	mm	"	mm	"	mm
G20309-0808	8GS-8FL60M	7347-45245	1/2	12.7	1.19	30.2	1.06	26.9	4.09	103.9	2.62	66.6	.27	6.9
G20309-1212	12GS-12FL60M	7347-45445	3/4	19.1	1.50	38.1	1.46	37.1	5.39	136.9	3.39	86.1	.27	6.9
G20309-1216	12GS-16FL60M	7347-45465	3/4	19.1	1.75	44.5	1.73	43.9	5.35	135.9	3.35	85.1	.32	8.1
G20309-1616	16GS-16FL60M	7347-45555	1	25.4	1.75	44.5	1.73	43.9	6.18	157.0	3.97	100.8	.32	8.1
G20309-1620	16GS-20FL60M	7347-45565	1	25.4	2.00	50.8	2.17	55.1	6.18	157.0	3.94	100.1	.32	8.1
G20309-2020	20GS-20FL60M	7347-45645	1 1/4	31.8	2.00	50.8	2.17	55.1	7.36	186.9	4.56	115.8	.32	8.1
G20309-2024	20GS-24FL60M	7347-45655	1 1/4	31.8	2.38	60.5	2.52	64.0	7.68	195.1	4.88	124.0	.32	8.1



### Code 61 O-Ring Flange - 67 1/2° Bent Tube

-8FL, -12FL, -16FL Max. W.P. 5,000 psi; -20FL Max. W.P. 4,000 psi.  
S, M and L Drops per ISO Final Draft International Standard 12151-3.  
See Accessories for O-Rings.

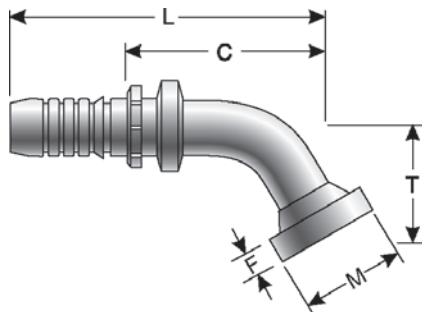

Part No.	Descr.	Prod. No.	⊖		M		T		L		C		F	
			"	mm	"	mm	"	mm	"	mm	"	mm	"	mm
G20311-0812	8GS-12FL67-032	7347-78025	1/2	12.7	1.50	38.1	1.26	32.0	3.70	94.0	2.21	56.1	.27	6.9
G20311-1212	12GS-12FL67M	7347-46445	3/4	19.1	1.50	38.1	1.65	41.9	5.20	132.1	3.19	81.0	.27	6.9
G20311-1216	12GS-16FL67M	7347-46465	3/4	19.1	1.75	44.5	2.01	51.1	5.08	129.0	3.07	78.0	.32	8.1
G20311-1616	16GS-16FL67M	7347-46555	1	25.4	1.75	44.5	2.01	51.1	5.94	150.9	3.71	94.2	.32	8.1
G20311-1620	16GS-20FL67M	7347-46565	1	25.4	2.00	50.8	2.52	64.0	5.83	148.1	3.59	91.2	.32	8.1
G20311-2020	20GS-20FL67M	7347-46645	1 1/4	31.8	2.00	50.8	2.52	64.0	7.01	178.1	4.21	106.9	.32	8.1
G20311-2024	20GS-24FL67S	7347-76605	1 1/4	31.8	2.38	60.5	2.01	51.1	6.46	164.1	3.66	93.0	.32	8.1

### Code 61 O-Ring Flange - 90° Bent Tube

-8FL, -12FL, -16FL Max. W.P. 5,000 psi; -20FL Max. W.P. 4,000 psi.  
S, M and L Drops per ISO Final Draft International Standard 12151-3.  
See Accessories for O-Rings.

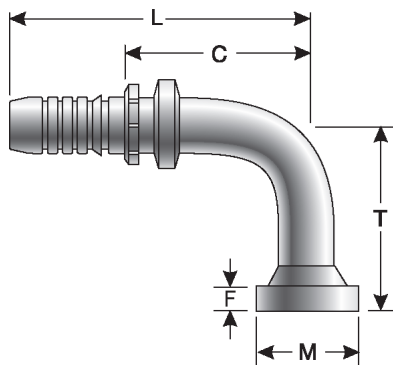

Part No.	Descr.	Prod. No.	⊖		M		T		L		C		F	
			"	mm	"	mm	"	mm	"	mm	"	mm	"	mm
G20315-0608	6GS-8FL90M	7347-74155	3/8	9.5	1.19	30.2	1.57	39.9	3.43	87.1	2.02	51.3	.27	6.9
G20315-0808	8GS-8FL90M	7347-74245	1/2	12.7	1.19	30.2	1.57	39.9	3.46	87.9	1.99	50.6	.27	6.9
G20316-0808	8GS-8FL90L	7347-73815	1/2	12.7	1.19	30.2	3.27	83.1	3.46	87.9	1.99	50.6	.27	6.9
G20315-0812	8GS-12FL90M	7347-74265	1/2	12.7	1.50	38.1	2.28	57.9	3.46	87.9	1.98	50.3	.27	6.9
G20315-1012	10GS-12FL90M	7347-74355	5/8	15.9	1.50	38.1	2.28	57.9	4.33	110.0	2.35	59.7	.27	6.9
G20314-1208	12GS-8FL90-050	7347-76035	3/4	19.1	1.19	30.2	1.97	50.0	4.80	121.9	2.80	71.1	.27	6.9
G20315-1212	12GS-12FL90M	7347-74445	3/4	19.1	1.50	38.1	2.28	57.9	4.41	112.0	2.40	61.0	.27	6.9
G20317-1212	12GS-12FL90-100	7347-73905	3/4	19.1	1.50	38.1	3.94	100.1	4.41	112.0	2.40	61.0	.27	6.9

EQUIPMENT
HOSE/CPLG. SELECTION
G8K COUPLINGS
GLOBALSPIRAL COUPLINGS
STAINLESS STEEL SPIRAL
MEGACRIMP COUPLINGS
STAINLESS STEEL BRAID
POWER CRIMP COUPLINGS
FIELD ATTACHABLE G1 & G2 COUPLINGS
FIELD ATTACHABLE C5 COUPLINGS
C14 COUPLINGS
GL COUPLINGS
GLX COUPLINGS
PCTS THERMOPLASTIC COUPLINGS
POLARSEAL COUPLINGS (ACA)
POLARSEAL II COUPLINGS (ACC)
POLARSEAL II COUPLINGS (ACB)
POWER STEERING
ADAPTERS
QUICK DISCONNECT COUPLERS
BALL VALVES
LIVE SWIVEL
ASSEMBLY FABRICATION
ACCESSORIES
EQUIPMENT AND PARTS
KITS
AIR BRAKE HOSE ASSY
BRASS



Code 61 O-Ring Flange - 90° Bent Tube - Continued

Part No.	Descr.	Prod. No.	⊖		M		T		L		C		F	
			"	mm	"	mm	"	mm	"	mm	"	mm	"	mm
G20318-1212	12GS-12FL90-125	7347-73985	3/4	19.1	1.50	38.1	4.92	125.0	4.80	121.9	2.80	71.1	.27	6.9
G20314-1216	12GS-16FL90S	7347-73915	3/4	19.1	1.75	44.5	2.40	61.0	4.41	112.0	2.40	61.0	.32	8.1
G20315-1216	12GS-16FL90M	7347-73925	3/4	19.1	1.75	44.5	2.76	70.1	4.41	112.0	2.40	61.0	.32	8.1
G20316-1216	12GS-16FL90-080	7347-76805	3/4	19.1	1.75	44.5	3.15	80.0	5.04	128.0	3.03	77.0	.32	8.1
G20319-1216	12GS-16FL90-178	7347-79025	3/4	19.1	1.75	44.5	7.01	178.1	4.41	112.0	2.38	60.5	.32	8.1
G20314-1220	12GS-20FL90-054	7347-73995	3/4	19.1	2.00	50.8	2.13	54.1	5.16	131.1	3.15	80.0	.32	8.1
G20317-1220	12GS-20FL90-125	7347-78375	3/4	19.1	2.00	50.8	4.92	125.0	4.76	120.9	2.76	70.1	.32	8.1
G20315-1612	16GS-12FL90M	7347-74535	1	25.4	1.50	38.1	2.28	57.9	5.31	134.9	5.08	129.0	.27	6.9
G20316-1612	16GS-12FL90	7347-73255	1	25.4	1.50	38.1	3.15	80.0	5.31	134.9	3.10	78.7	.27	6.9
G20314-1616	16GS-16FL90S	7347-47555	1	25.4	1.75	44.5	2.40	61.0	5.31	134.9	3.09	78.5	.32	8.1
G20315-1616	16GS-16FL90M	7347-74555	1	25.4	1.75	44.5	2.76	70.1	5.31	134.9	3.09	78.5	.32	8.1
G20317-1616	16GS-16FL90-120	7347-73165	1	25.4	1.75	44.5	4.72	119.9	5.28	134.1	3.04	77.2	.32	8.1
G20318-1616	16GS-16FL90-150	7347-78705	1	25.4	1.75	44.5	5.91	150.1	5.67	144.0	3.44	87.4	.32	8.1
G20319-1616	16GS-16FL90-210	7347-78875	1	25.4	1.75	44.5	8.27	210.1	5.28	134.1	3.02	76.7	.32	8.1
G20314-1620	16GS-20FL90S	7347-47565	1	25.4	2.00	50.8	2.68	68.1	5.28	134.1	3.02	76.7	.32	8.1
G20315-1620	16GS-20FL90M	7347-74565	1	25.4	2.00	50.8	3.54	89.9	5.28	134.1	2.99	76.0	.32	8.1
G20317-1620	16GS-20FL90-120	7347-76495	1	25.4	2.00	50.8	4.72	119.9	5.28	134.1	3.04	77.2	.32	8.1
G20313-1624	16GS-24FL90-060	7347-73975	1	25.4	2.38	60.5	2.36	59.9	5.71	145.0	3.47	88.1	.32	8.1
G20314-1624	16GS-24FL90S	7347-47575	1	25.4	2.38	60.5	3.19	81.0	5.28	134.1	3.04	77.2	.32	8.1
G20315-2016	20GS-16FL90M	7347-74635	1 1/4	31.8	1.75	44.5	2.76	70.1	6.30	160.0	3.50	88.9	.32	8.1
G20316-2016	20GS-16FL90-215	7347-78885	1 1/4	31.8	1.75	44.5	8.46	214.9	6.30	160.0	3.50	88.9	.32	8.1
G20314-2020	20GS-20FL90S	7347-47645	1 1/4	31.8	2.00	50.8	2.68	68.1	6.50	165.1	3.70	94.0	.32	8.1
G20315-2020	20GS-20FL90M	7347-74645	1 1/4	31.8	2.00	50.8	3.54	89.9	6.50	165.1	3.70	94.0	.32	8.1
G20317-2020	20GS-20FL90-168	7347-76105	1 1/4	31.8	2.00	50.8	6.61	167.9	6.54	166.1	3.74	95.0	.32	8.1
G20314-2024	20GS-24FL90S	7347-47655	1 1/4	31.8	2.38	60.5	3.19	81.0	6.50	165.1	3.70	94.0	.32	8.1
G20315-2024	20GS-24FL90-118	7347-76085	1 1/4	31.8	2.38	60.5	4.65	118.1	6.50	165.1	3.70	94.0	.32	8.1

Code 61 Komatsu Style O-Ring Flange - 90° Bent Tube

See Accessories for O-Rings.

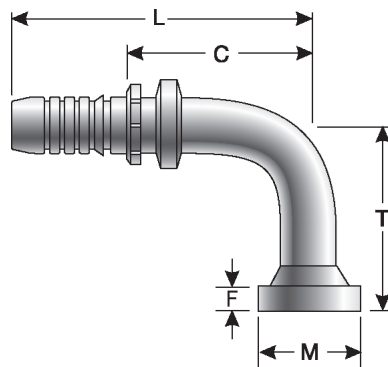

Part No.	Descr.	Prod. No.	⊖		M		T		L		C		F	
			"	mm	"	mm	"	mm	"	mm	"	mm	"	mm
G20315-1010	10GS-10FLK90-055	7347-73355	5/8	15.9	1.35	34.3	2.17	55.1	4.33	110.0	2.35	59.7	.27	6.9
G20315-1210	12GS-10FLK90-055	7347-73695	3/4	19.1	1.35	34.3	2.17	55.1	4.65	118.1	2.64	67.1	.27	6.9



### Code 61 O-Ring Flange - 100° Bent Tube

-8FL, -12FL, -16FL Max. W.P. 5,000 psi; -20FL Max. W.P. 4,000 psi.  
See Accessories for O-Rings.

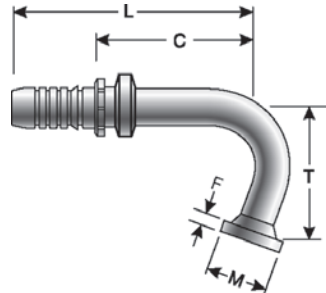

Part No.	Descr.	Prod. No.	⊕		M		T		L		C		F	
			"	mm	"	mm	"	mm	"	mm	"	mm	"	mm
G20323-1216	12GS-16FL100-059	7347-78055	3/4	19.1	1.75	44.5	2.32	58.9	4.93	125.2	2.92	74.2	.32	8.1

### Code 61 O-Ring Flange - 110° Bent Tube

-8FL, -12FL, -16FL Max. W.P. 5,000 psi; -20FL Max. W.P. 4,000 psi.  
See Accessories for O-Rings.

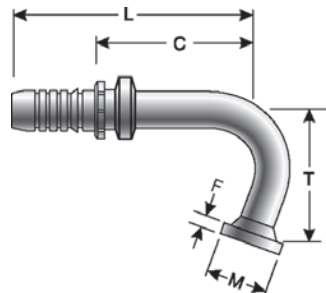

Part No.	Descr.	Prod. No.	⊕		M		T		L		C		F	
			"	mm	"	mm	"	mm	"	mm	"	mm	"	mm
G20325-1212	12GS-12FL110-064	7347-76025	3/4	19.1	1.50	38.1	2.52	64.0	5.16	131.1	3.15	80.0	.27	6.9
G20325-1616	16GS-16FL110-073	7347-73005	1	25.4	1.75	44.5	2.87	72.9	5.83	148.1	3.61	91.7	.32	8.1
G20325-1620	16GS-20FL110-073	7347-76455	1	25.4	2.00	50.8	2.87	72.9	4.65	118.1	2.41	61.2	.32	8.1
G20325-2020	20GS-20FL110-080	7347-76115	1 1/4	31.8	2.00	50.8	3.15	80.0	7.13	181.1	4.33	110.0	.32	8.1
G20325-2024	20GS-24FL110-080	7347-76125	1 1/4	31.8	2.38	60.5	3.15	80.0	7.13	181.1	4.33	110.0	.32	8.1

EQUIPMENT
HOSE/CPLG. SELECTION
G8K COUPLINGS
GLOBALSPIRAL COUPLINGS
STAINLESS STEEL SPIRAL
MEGACRIMP COUPLINGS
STAINLESS STEEL BRAID
POWER CRIMP COUPLINGS
FIELD ATTACHABLE G1 & G2 COUPLINGS
FIELD ATTACHABLE C5 COUPLINGS
C14 COUPLINGS
GL COUPLINGS
GLX COUPLINGS
PCTS THERMOPLASTIC COUPLINGS
POLARSEAL COUPLINGS (ACA)
POLARSEAL II COUPLINGS (ACC)
POLARSEAL II COUPLINGS (ACB)
POWER STEERING
ADAPTERS
QUICK DISCONNECT COUPLERS
BALL VALVES
LIVE SWIVEL
ASSEMBLY FABRICATION
ACCESSORIES
EQUIPMENT AND PARTS
KITS
AIR BRAKE HOSE ASSY
BRASS





EQUIPMENT
HOSE/CPLG. SELECTION
G8K COUPLINGS
<b>GLOBALSPIRAL COUPLINGS</b>
STAINLESS STEEL SPIRAL
MEGACRIMP COUPLINGS
STAINLESS STEEL BRAID
POWER CRIMP COUPLINGS
FIELD ATTACHABLE G1 & G2 COUPLINGS
FIELD ATTACHABLE C5 COUPLINGS
C14 COUPLINGS
GL COUPLINGS
GLX COUPLINGS
PCTS THERMOPLASTIC COUPLINGS
POLARSEAL COUPLINGS (ACA)
POLARSEAL II COUPLINGS (ACC)
POLARSEAL II COUPLINGS (ACB)
POWER STEERING
ADAPTERS
QUICK DISCONNECT COUPLERS
BALL VALVES
LIVE SWIVEL
ASSEMBLY FABRICATION
ACCESSORIES
EQUIPMENT AND PARTS
KITS
AIR BRAKE HOSE ASSY
BRASS

### Code 61 O-Ring Flange - 135° Bent Tube

-8FL, -12FL, -16FL Max. W.P. 5,000 psi; -20FL Max. W.P. 4,000 psi.  
See Accessories for O-Rings.

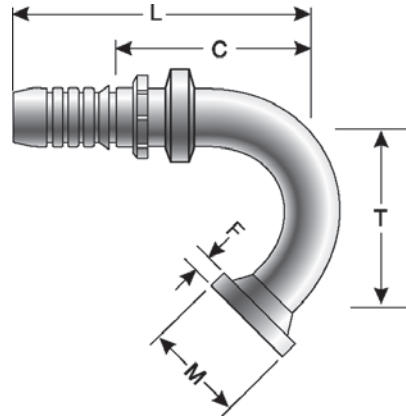

Part No.	Descr.	Prod. No.	⊖		M		T		L		C		F	
			"	mm	"	mm	"	mm	"	mm	"	mm	"	mm
G20331-1212	12GS-12FL135-070	7347-76825	3/4	19.1	1.50	38.1	2.76	70.1	3.82	97.0	1.81	46.0	.27	6.9

### Code 62 O-Ring Flange Heavy

All FLH sizes Maximum Working Pressure 6,000 PSI.  
See Accessories for O-Rings.

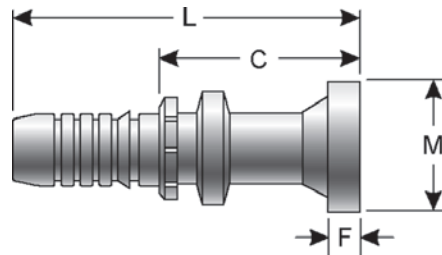

Part No.	Descr.	Prod. No.	⊖		M		L		C		F	
			"	mm	"	mm	"	mm	"	mm	"	mm
G20350-0808	8GS-8FLH	7347-48245	1/2	12.7	1.25	31.8	3.66	93.0	2.19	55.6	.31	7.9
G20350-0812	8GS-12FLH	7347-48265	1/2	12.7	1.63	41.4	3.66	93.0	2.19	55.6	.35	8.9
G20350-1008	10GS-8FLH	7347-48335	5/8	15.9	1.25	31.8	4.29	109.0	2.31	58.7	.31	7.9
G20350-1012	10GS-12FLH	7347-48355	5/8	15.9	1.63	41.4	4.29	109.0	2.31	58.7	.35	8.9
G20350-1212	12GS-12FLH	7347-48445	3/4	19.1	1.63	41.4	4.49	114.1	2.48	63.0	.35	8.9
G20350-1216	12GS-16FLH	7347-48465	3/4	19.1	1.88	47.8	4.49	114.1	2.48	63.0	.38	9.7
G20350-1612	16GS-12FLH	7347-48535	1	25.4	1.63	41.4	5.08	129.0	2.86	72.6	.35	8.9
G20350-1616	16GS-16FLH	7347-48555	1	25.4	1.88	47.8	4.92	125.0	2.70	68.6	.38	9.7
G20350-1620	16GS-20FLH	7347-48565	1	25.4	2.13	54.1	4.92	125.0	2.69	68.3	.41	10.4
G20350-2016	20GS-16FLH	7347-48635	1 1/4	31.8	1.88	47.8	6.42	163.1	3.62	92.0	.38	9.7
G20350-2020	20GS-20FLH	7347-48645	1 1/4	31.8	2.13	54.1	5.75	146.1	2.95	74.9	.41	10.4
G20350-2024	20GS-24FLH	7347-48655	1 1/4	31.8	2.50	63.5	6.30	160.0	3.50	88.9	.50	12.7



### Code 62 O-Ring Flange Heavy - 22 1/2° Bent Tube

All FLH sizes Maximum Working Pressure 6,000 PSI.  
S, M and L Drops per ISO Final Draft International Standard 12151-3.  
See Accessories for O-Rings.

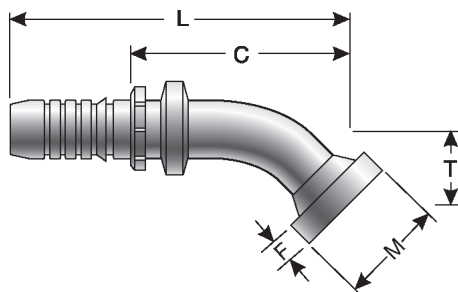

Part No.	Descr.	Prod. No.	⊖		M		T		L		C		F	
			"	mm	"	mm	"	mm	"	mm	"	mm	"	mm
G20352-1216	12GS-16FLH22M	7347-49465	3/4	19.1	1.88	47.8	.55	14.0	5.43	137.9	3.43	87.1	.38	9.7
G20352-1616	16GS-16FLH22M	7347-49555	1	25.4	1.88	47.8	.55	14.0	6.10	154.9	3.88	98.6	.38	9.7
G20352-1620	16GS-20FLH22M	7347-49565	1	25.4	2.13	54.1	.59	15.0	6.61	167.9	4.52	114.8	.41	10.4
G20352-2020	20GS-20FLH22M	7347-49645	1 1/4	31.8	2.13	54.1	.59	15.0	7.32	185.9	4.52	114.8	.41	10.4
G20352-2024	20GS-24FLH22M	7347-49655	1 1/4	31.8	2.50	63.5	.71	18.0	7.40	188.0	4.60	116.8	.50	12.7

### Code 62 O-Ring Flange Heavy - 30° Bent Tube

All FLH sizes Maximum Working Pressure 6,000 PSI.  
S, M and L Drops per ISO Final Draft International Standard 12151-3.  
See Accessories for O-Rings.

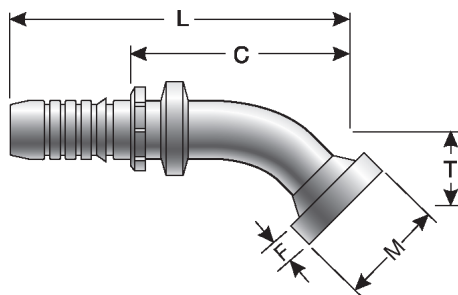

Part No.	Descr.	Prod. No.	⊖		M		T		L		C		F	
			"	mm	"	mm	"	mm	"	mm	"	mm	"	mm
G20354-1212	12GS-12FLH30M	7347-50445	3/4	19.1	1.63	41.4	.63	16.0	5.08	129.0	3.07	78.0	.35	8.9
G20354-1216	12GS-16FLH30M	7347-50465	3/4	19.1	1.88	47.8	.75	19.1	5.08	129.0	3.07	78.0	.38	9.7
G20354-1616	16GS-16FLH30M	7347-50555	1	25.4	1.88	47.8	.75	19.1	6.02	152.9	3.80	96.5	.38	9.7
G20354-1620	16GS-20FLH30M	7347-50565	1	25.4	2.13	54.1	1.50	38.1	6.22	158.0	3.98	101.1	.41	10.4
G20354-2020	20GS-20FLH30M	7347-50645	1 1/4	31.8	2.13	54.1	.87	22.1	7.24	183.9	4.44	112.8	.41	10.4
G20354-2024	20GS-24FLH30M	7347-50655	1 1/4	31.8	2.50	63.5	1.18	30.0	7.24	183.9	4.44	112.8	.50	12.7

- EQUIPMENT
- HOSE/CPLG. SELECTION
- G8K COUPLINGS
- GLOBALSPIRAL COUPLINGS
- STAINLESS STEEL SPIRAL
- MEGACRIMP COUPLINGS
- STAINLESS STEEL BRAID
- POWER CRIMP COUPLINGS
- FIELD ATTACHABLE G1 & G2 COUPLINGS
- FIELD ATTACHABLE C5 COUPLINGS
- C14 COUPLINGS
- GL COUPLINGS
- GLX COUPLINGS
- PCTS THERMOPLASTIC COUPLINGS
- POLARSEAL COUPLINGS (ACA)
- POLARSEAL II COUPLINGS (ACC)
- POLARSEAL II COUPLINGS (ACB)
- POWER STEERING
- ADAPTERS
- QUICK DISCONNECT COUPLERS
- BALL VALVES
- LIVE SWIVEL
- ASSEMBLY FABRICATION
- ACCESSORIES
- EQUIPMENT AND PARTS
- KITS
- AIR BRAKE HOSE ASSY
- BRASS



EQUIPMENT
HOSE/CPLG. SELECTION
G8K COUPLINGS
GLOBALSPIRAL COUPLINGS
STAINLESS STEEL SPIRAL
MEGACRIMP COUPLINGS
STAINLESS STEEL BRAID
POWER CRIMP COUPLINGS
FIELD ATTACHABLE G1 & G2 COUPLINGS
FIELD ATTACHABLE C5 COUPLINGS
C14 COUPLINGS
GL COUPLINGS
GLX COUPLINGS
PCTS THERMOPLASTIC COUPLINGS
POLARSEAL COUPLINGS (ACA)
POLARSEAL II COUPLINGS (ACC)
POLARSEAL II COUPLINGS (ACB)
POWER STEERING
ADAPTERS
QUICK DISCONNECT COUPLERS
BALL VALVES
LIVE SWIVEL
ASSEMBLY FABRICATION
ACCESSORIES
EQUIPMENT AND PARTS
KITS
AIR BRAKE HOSE ASSY
BRASS

### Code 62 O-Ring Flange Heavy - 45° Bent Tube

All FLH sizes Maximum Working Pressure 6,000 PSI.  
S, M and L Drops per ISO Final Draft International Standard 12151-3.  
See Accessories for O-Rings.

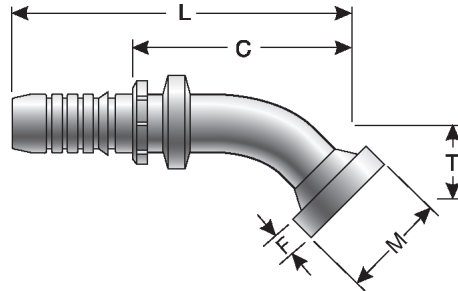

Part No.	Descr.	Prod. No.	⊖		M		T		L		C		F	
			"	mm	"	mm	"	mm	"	mm	"	mm	"	mm
G20357-0808	8GS-8FLH45M	7347-51245	1/2	12.7	1.25	31.8	.75	19.1	3.70	94.0	2.22	56.4	.31	7.9
G20357-0812	8GS-12FLH45M	7347-51265	1/2	12.7	1.63	41.4	1.02	25.9	3.98	101.1	2.50	63.5	.35	8.9
G20357-1012	10GS-12FLH45M	7347-51355	5/8	15.9	1.63	41.4	1.02	25.9	5.00	127.0	3.02	76.7	.35	8.9
G20357-1208	12GS-8FLH45M	7347-51425	3/4	19.1	1.25	31.8	.75	19.1	4.56	115.8	2.55	64.8	.31	7.9
G20357-1212	12GS-12FLH45M	7347-51445	3/4	19.1	1.63	41.4	1.02	25.9	4.88	124.0	2.87	72.9	.35	8.9
G20357-1216	12GS-16FLH45M	7347-51465	3/4	19.1	1.88	47.8	1.26	32.0	5.12	130.1	3.11	79.0	.38	9.7
G20357-1612	16GS-12FLH45M	7347-51535	1	25.4	1.63	41.4	1.02	25.9	5.55	141.0	3.33	84.6	.35	8.9
G20357-1616	16GS-16FLH45M	7347-51555	1	25.4	1.88	47.8	1.26	32.0	5.79	147.1	3.57	90.7	.38	9.7
G20357-1620	16GS-20FLH45M	7347-51565	1	25.4	2.13	54.1	1.50	38.1	6.22	158.0	3.98	101.1	.41	10.4
G20357-2016	20GS-16FLH45M	7347-51635	1 1/4	31.8	1.88	47.8	1.26	32.0	6.73	170.9	3.93	99.8	.38	9.7
G20357-2020	20GS-20FLH45M	7347-51645	1 1/4	31.8	2.13	54.1	1.50	38.1	6.93	176.0	4.13	104.9	.41	10.4
G20357-2024	20GS-24FLH45M	7347-51655	1 1/4	31.8	2.50	63.5	1.73	43.9	6.93	176.0	4.13	104.9	.50	12.7

### Code 62 O-Ring Flange Heavy - 60° Bent Tube

All FLH sizes Maximum Working Pressure 6,000 PSI.  
S, M and L Drops per ISO Final Draft International Standard 12151-3.  
See Accessories for O-Rings.

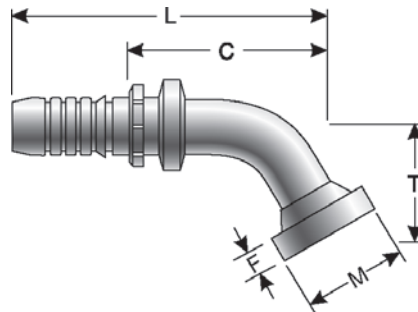

Part No.	Descr.	Prod. No.	⊖		M		T		L		C		F	
			"	mm	"	mm	"	mm	"	mm	"	mm	"	mm
G20359-1212	12GS-12FLH60M	7347-52445	3/4	19.1	1.63	41.4	1.46	37.1	5.39	136.9	3.39	86.1	.35	8.9
G20359-1216	12GS-16FLH60M	7347-52465	3/4	19.1	1.88	47.8	1.73	43.9	5.35	135.9	3.35	85.1	.38	9.7
G20359-1616	16GS-16FLH60M	7347-52555	1	25.4	1.88	47.8	1.73	43.9	6.18	157.0	3.96	100.6	.38	9.7
G20359-2020	20GS-20FLH60M	7347-52645	1 1/4	31.8	2.13	54.1	2.17	55.1	7.32	185.9	4.52	114.8	.41	10.4
G20359-2024	20GS-24FLH60M	7347-52655	1 1/4	31.8	2.50	63.5	2.52	64.0	7.64	194.1	4.84	122.9	.50	12.7



### Code 62 O-Ring Flange Heavy - 67 1/2° Bent Tube

All FLH sizes Maximum Working Pressure 6,000 PSI.  
S, M and L Drops per ISO Final Draft International Standard 12151-3.  
See Accessories for O-Rings.

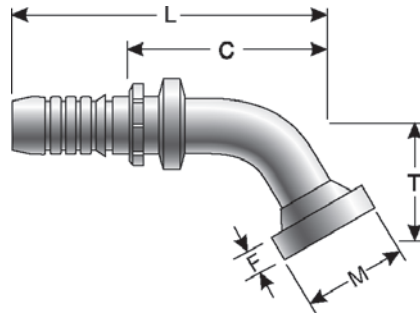

Part No.	Descr.	Prod. No.	⊖		M		T		L		C		F	
			"	mm	"	mm	"	mm	"	mm	"	mm	"	mm
G20360-1616	16GS-16FLH67M	7347-53555	1	25.4	1.88	47.8	2.01	51.1	5.94	150.9	3.72	94.5	.38	9.7

### Code 62 O-Ring Flange Heavy - 90° Bent Tube

All FLH sizes Maximum Working Pressure 6,000 PSI.  
S, M and L Drops per ISO Final Draft International Standard 12151-3.  
See Accessories for O-Rings.

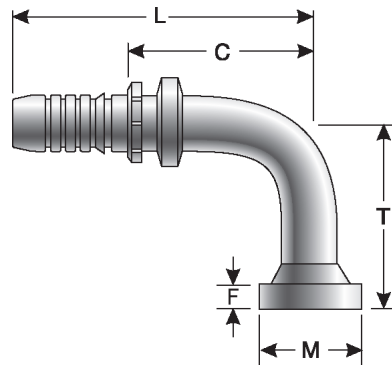

Part No.	Descr.	Prod. No.	⊖		M		T		L		C		F	
			"	mm	"	mm	"	mm	"	mm	"	mm	"	mm
G20365-0808	8GS-8FLH90M	7347-75245	1/2	12.7	1.25	31.8	1.57	39.9	3.46	87.9	1.99	50.6	.31	7.9
G20366-0808	8GS-8FLH90-080	7347-73825	1/2	12.7	1.25	31.8	3.15	80.0	3.46	87.9	1.99	50.6	.31	7.9
G20365-0812	8GS-12FLH90M	7347-75265	1/2	12.7	1.63	41.4	2.28	57.9	3.46	87.9	1.99	50.6	.35	8.9
G20365-1008	10GS-8FLH90M	7347-75335	5/8	15.9	1.25	31.8	1.57	39.9	4.45	113.0	2.47	62.7	.31	7.9
G20365-1012	10GS-12FLH90M	7347-75355	5/8	15.9	1.63	41.4	2.28	57.9	4.33	110.0	2.35	59.7	.35	8.9
G20365-1212	12GS-12FLH90M	7347-75445	3/4	19.1	1.63	41.4	2.28	57.9	4.41	112.0	2.40	61.0	.35	8.9
G20366-1212	12GS-12FLH90-100	7347-73835	3/4	19.1	1.63	41.4	3.94	100.1	4.41	112.0	2.40	61.0	.35	8.9
G20367-1212	12GS-12FLH90-122	7347-76415	3/4	19.1	1.63	41.4	4.80	121.9	4.80	121.9	2.80	71.1	.35	8.9
G20364-1216	12GS-16FLH90S	7347-54465	3/4	19.1	1.88	47.8	2.40	61.0	4.41	112.0	2.40	61.0	.38	9.7
G20365-1216	12GS-16FLH90M	7347-73935	3/4	19.1	1.88	47.8	2.76	70.1	4.41	112.0	2.40	61.0	.38	9.7
G20367-1216	12GS-16FLH90-140	7347-76715	3/4	19.1	1.88	47.8	5.51	140.0	4.57	116.1	2.56	65.0	.38	9.7
G20365-1220	12GS-20FLH90M	7347-75475	3/4	19.1	2.13	54.1	3.54	89.9	4.80	121.9	2.80	71.1	.41	10.4
G20365-1612	16GS-12FLH90M	7347-54535	1	25.4	1.63	41.4	2.28	57.9	5.31	134.9	3.09	78.5	.35	8.9
G20364-1616	16GS-16FLH90S	7347-54555	1	25.4	1.88	47.8	2.40	61.0	5.31	134.9	3.09	78.5	.38	9.7

- EQUIPMENT
- HOSE/CPLG. SELECTION
- G8K COUPLINGS
- GLOBALSPIRAL COUPLINGS
- STAINLESS STEEL SPIRAL
- MEGACRIMP COUPLINGS
- STAINLESS STEEL BRAID
- POWER CRIMP COUPLINGS
- FIELD ATTACHABLE G1 & G2 COUPLINGS
- FIELD ATTACHABLE C5 COUPLINGS
- C14 COUPLINGS
- GL COUPLINGS
- GLX COUPLINGS
- PCTS THERMOPLASTIC COUPLINGS
- POLARSEAL COUPLINGS (ACA)
- POLARSEAL II COUPLINGS (ACC)
- POLARSEAL II COUPLINGS (ACB)
- POWER STEERING
- ADAPTERS
- QUICK DISCONNECT COUPLERS
- BALL VALVES
- LIVE SWIVEL
- ASSEMBLY FABRICATION
- ACCESSORIES
- EQUIPMENT AND PARTS
- KITS
- AIR BRAKE HOSE ASSY
- BRASS



EQUIPMENT
HOSE/CPLG. SELECTION
G8K COUPLINGS
GLOBALSPIRAL COUPLINGS
STAINLESS STEEL SPIRAL
MEGACRIMP COUPLINGS
STAINLESS STEEL BRAID
POWER CRIMP COUPLINGS
FIELD ATTACHABLE G1 & G2 COUPLINGS
FIELD ATTACHABLE C5 COUPLINGS
C14 COUPLINGS
GL COUPLINGS
GLX COUPLINGS
PCTS THERMOPLASTIC COUPLINGS
POLARSEAL COUPLINGS (ACA)
POLARSEAL II COUPLINGS (ACC)
POLARSEAL II COUPLINGS (ACB)
POWER STEERING ADAPTERS
QUICK DISCONNECT COUPLERS
BALL VALVES
LIVE SWIVEL
ASSEMBLY FABRICATION
ACCESSORIES
EQUIPMENT AND PARTS
KITS
AIR BRAKE HOSE ASSY
BRASS

### Code 62 O-Ring Flange Heavy - 90° Bent Tube - Continued

Part No.	Descr.	Prod. No.	⊖		M		T		L		C		F	
			"	mm	"	mm	"	mm	"	mm	"	mm	"	mm
G20365-1616	16GS-16FLH90M	7347-75555	1	25.4	1.88	47.8	2.76	70.1	5.31	134.9	3.09	78.5	.38	9.7
G20366-1616	16GS-16FLH90-120	7347-73015	1	25.4	1.88	47.8	4.72	119.9	5.28	134.1	3.04	77.2	.38	9.7
G20367-1616	16GS-16FLH90-090	7347-78105	1	25.4	1.88	47.8	3.54	89.9	5.52	140.2	3.28	83.3	.38	9.7
G20364-1620	16GS-20FLH90S	7347-54565	1	25.4	2.13	54.1	2.68	68.1	5.28	134.1	3.02	76.7	.41	10.4
G20365-1620	16GS-20FLH90M	7347-75565	1	25.4	2.13	54.1	3.54	89.9	5.28	134.1	3.02	76.7	.41	10.4
G20364-1624	16GS-24FLH90S	7347-54575	1	25.4	2.50	63.5	3.19	81.0	5.28	134.1	3.04	77.2	.50	12.7
G20364-2016	20GS-16FLH90S	7347-54635	1 1/4	31.8	1.88	47.8	2.40	61.0	6.30	160.0	3.50	88.9	.38	9.7
G20365-2016	20GS-16FLH90M	7347-75635	1 1/4	31.8	1.88	47.8	2.76	70.1	6.30	160.0	3.50	88.9	.38	9.7
G20366-2016	20GS-16FLH90-100	7347-76185	1 1/4	31.8	1.88	47.8	3.94	100.1	6.30	160.0	3.50	88.9	.38	9.7
G20364-2020	20GS-20FLH90-076	7347-73635	1 1/4	31.8	2.13	54.1	2.99	76.0	6.50	165.1	3.70	94.0	.41	10.4
G20365-2020	20GS-20FLH90M	7347-75645	1 1/4	31.8	2.13	54.1	3.54	89.9	6.50	165.1	3.70	94.0	.41	10.4
G20366-2020	20GS-20FLH90-120	7347-76135	1 1/4	31.8	2.13	54.1	4.72	119.9	6.50	165.1	3.70	94.0	.41	10.4
G20367-2020	20GS-20FLH90-152	7347-76485	1 1/4	31.8	2.13	54.1	5.98	151.9	6.50	165.1	3.70	94.0	.41	10.4
G20364-2024	20GS-24FLH90S	7347-54655	1 1/4	31.8	2.50	63.5	3.19	81.0	6.50	165.1	3.70	94.0	.50	12.7

### Code 62 O-Ring Flange Heavy - 110° Bent Tube

All FLH sizes Maximum Working Pressure 6,000 PSI.

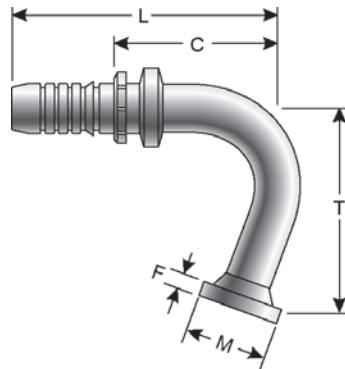

Part No.	Descr.	Prod. No.	⊖		M		T		L		C		F	
			"	mm	"	mm	"	mm	"	mm	"	mm	"	mm
G20369-1212	12GS-12FLH110-064	7347-78525	3/4	19.1	1.63	41.4	2.76	70.1	3.82	97.0	1.81	46.0	.35	8.9



### Caterpillar Style O-Ring Flange

NOTE: These FLC flanges are designed with a thicker flange head. The .56" flange dimension is frequently found on Caterpillar equipment. These flanges let the user utilize the existing Caterpillar flange halves or new Gates Caterpillar flange halves. At the user's option, standard Code 62 flanges and halves can be used in place of Caterpillar flanges and halves. The standard Code 62 flange head thickness ranges between .305" and .495". Compatible with Code 62 O-Ring. See Accessories for recommended O-Rings. (Do Not use "D" shaped O-Rings).

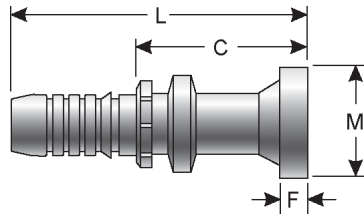

Part No.	Descr.	Prod. No.	⊖		M		L		C		F	
			"	mm	"	mm	"	mm	"	mm	"	mm
G20400-1212	12GS-12FLC	7347-62445	3/4	19.1	1.63	41.4	5.71	145.0	3.70	94.0	.56	14.2
G20400-1216	12GS-16FLC	7347-62465	3/4	19.1	1.88	47.8	5.71	145.0	3.70	94.0	.56	14.2
G20400-1616	16GS-16FLC	7347-62555	1	25.4	1.88	47.8	6.10	154.9	3.87	98.3	.56	14.2
G20400-1620	16GS-20FLC	7347-62565	1	25.4	2.13	54.1	6.10	154.9	3.87	98.3	.56	14.2
G20400-2020	20GS-20FLC	7347-62645	1 1/4	31.8	2.13	54.1	7.36	186.9	4.56	115.8	.56	14.2
G20400-2024	20GS-24FLC	7347-62655	1 1/4	31.8	2.50	63.5	7.36	186.9	4.56	115.8	.56	14.2

### Caterpillar Style O-Ring Flange - 22 1/2° Bent Tube

NOTE: These FLC flanges are designed with a thicker flange head. The .56" flange dimension is frequently found on Caterpillar equipment. These flanges let the user utilize the existing Caterpillar flange halves or new Gates Caterpillar flange halves. At the user's option, standard Code 62 flanges and halves can be used in place of Caterpillar flanges and halves. The standard Code 62 flange head thickness ranges between .305" and .495". Compatible with Code 62 O-Ring. See Accessories for recommended O-Rings. (Do Not use "D" shaped O-Rings).

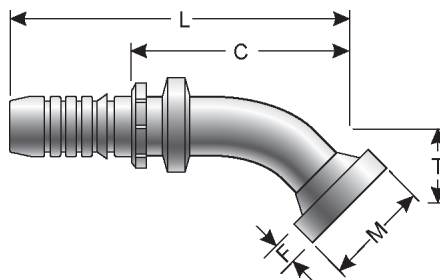

Part No.	Descr.	Prod. No.	⊖		M		T		L		C		F	
			"	mm	"	mm	"	mm	"	mm	"	mm	"	mm
G20402-1212	12GS-12FLC22-016	7347-63445	3/4	19.1	1.63	41.4	.63	16.0	5.63	143.0	3.62	92.0	.56	14.2
G20402-1616	16GS-16FLC22-017	7347-63555	1	25.4	1.88	47.8	.67	17.0	6.02	152.9	3.78	96.0	.56	14.2
G20402-1620	16GS-20FLC22-017	7347-63565	1	25.4	2.13	54.1	.67	17.0	6.02	152.9	3.78	96.0	.56	14.2
G20402-2020	20GS-20FLC22-017	7347-63645	1 1/4	31.8	2.13	54.1	.67	17.0	7.28	184.9	4.48	113.8	.56	14.2
G20402-2024	20GS-24FLC22-017	7347-63655	1 1/4	31.8	2.50	63.5	.67	17.0	7.28	184.9	4.48	113.8	.56	14.2

- EQUIPMENT
- HOSE/CPLG. SELECTION
- G8K COUPLINGS
- GLOBALSPIRAL COUPLINGS
- STAINLESS STEEL SPIRAL
- MEGACRIMP COUPLINGS
- STAINLESS STEEL BRAID
- POWER CRIMP COUPLINGS
- FIELD ATTACHABLE G1 & G2 COUPLINGS
- FIELD ATTACHABLE C5 COUPLINGS
- C14 COUPLINGS
- GL COUPLINGS
- GLX COUPLINGS
- PCTS THERMOPLASTIC COUPLINGS
- POLARSEAL COUPLINGS (ACA)
- POLARSEAL II COUPLINGS (ACC)
- POLARSEAL II COUPLINGS (ACB)
- POWER STEERING
- ADAPTERS
- QUICK DISCONNECT COUPLERS
- BALL VALVES
- LIVE SWIVEL
- ASSEMBLY FABRICATION
- ACCESSORIES
- EQUIPMENT AND PARTS
- KITS
- AIR BRAKE HOSE ASSY
- BRASS





EQUIPMENT
HOSE/CPLG. SELECTION
G8K COUPLINGS
GLOBALSPIRAL COUPLINGS
STAINLESS STEEL SPIRAL
MEGACRIMP COUPLINGS
STAINLESS STEEL BRAID
POWER CRIMP COUPLINGS
FIELD ATTACHABLE G1 & G2 COUPLINGS
FIELD ATTACHABLE C5 COUPLINGS
C14 COUPLINGS
GL COUPLINGS
GLX COUPLINGS
PCTS THERMOPLASTIC COUPLINGS
POLARSEAL COUPLINGS (ACA)
POLARSEAL II COUPLINGS (ACC)
POLARSEAL II COUPLINGS (ACB)
POWER STEERING
ADAPTERS
QUICK DISCONNECT COUPLERS
BALL VALVES
LIVE SWIVEL
ASSEMBLY FABRICATION
ACCESSORIES
EQUIPMENT AND PARTS
KITS
AIR BRAKE HOSE ASSY
BRASS

### Caterpillar Style O-Ring Flange - 30° Bent Tube

NOTE: These FLC flanges are designed with a thicker flange head. The .56" flange dimension is frequently found on Caterpillar equipment. These flanges let the user utilize the existing Caterpillar flange halves or new Gates Caterpillar flange halves. At the user's option, standard Code 62 flanges and halves can be used in place of Caterpillar flanges and halves. The standard Code 62 flange head thickness ranges between .305" and .495". Compatible with Code 62 O-Ring. See Accessories for recommended O-Rings. (Do Not use "D" shaped O-Rings).

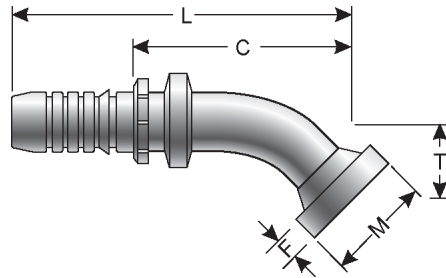

Part No.	Descr.	Prod. No.	⊕		M		T		L		C		F	
			"	mm	"	mm	"	mm	"	mm	"	mm	"	mm
G20404-1212	12GS-12FLC30-022	7347-64445	3/4	19.1	1.63	41.4	.87	22.1	5.51	140.0	3.50	88.9	.56	14.2
G20404-1216	12GS-16FLC30-022	7347-64465	3/4	19.1	1.88	47.8	.87	22.1	5.55	141.0	3.54	89.9	.56	14.2
G20404-1616	16GS-16FLC30-023	7347-64555	1	25.4	1.88	47.8	.91	23.1	5.94	150.9	3.69	93.7	.56	14.2
G20404-1620	16GS-20FLC30-023	7347-64565	1	25.4	2.13	54.1	.91	23.1	5.94	150.9	3.69	93.7	.56	14.2
G20404-2020	20GS-20FLC30-024	7347-64645	1 1/4	31.8	2.13	54.1	.94	23.9	7.20	182.9	4.41	112.0	.56	14.2
G20404-2024	20GS-24FLC30-024	7347-64655	1 1/4	31.8	2.50	63.5	.94	23.9	7.20	182.9	4.41	112.0	.56	14.2

### Caterpillar Style O-Ring Flange - 45° Bent Tube

NOTE: These FLC flanges are designed with a thicker flange head. The .56" flange dimension is frequently found on Caterpillar equipment. These flanges let the user utilize the existing Caterpillar flange halves or new Gates Caterpillar flange halves. At the user's option, standard Code 62 flanges and halves can be used in place of Caterpillar flanges and halves. The standard Code 62 flange head thickness ranges between .305" and .495". Compatible with Code 62 O-Ring. See Accessories for recommended O-Rings. (Do Not use "D" shaped O-Rings).

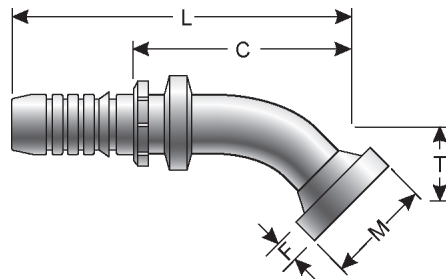

Part No.	Descr.	Prod. No.	⊕		M		T		L		C		F	
			"	mm	"	mm	"	mm	"	mm	"	mm	"	mm
G20407-1212	12GS-12FLC45-035	7347-65445	3/4	19.1	1.63	41.4	1.38	35.1	5.24	133.1	3.23	82.0	.56	14.2
G20408-1212	12GS-12FLC45-066	7347-76425	3/4	19.1	1.63	41.4	2.60	66.0	6.50	165.1	4.49	114.1	.56	14.2
G20407-1216	12GS-16FLC45-035	7347-65465	3/4	19.1	1.88	47.8	1.38	35.1	5.24	133.1	3.23	82.0	.56	14.2
G20407-1616	16GS-16FLC45-037	7347-65555	1	25.4	1.88	47.8	1.46	37.1	5.63	143.0	3.40	86.4	.56	14.2
G20407-1620	16GS-20FLC45-037	7347-65565	1	25.4	2.13	54.1	1.46	37.1	5.63	143.0	3.40	86.4	.56	14.2
G20407-2020	20GS-20FLC45-037	7347-65645	1 1/4	31.8	2.13	54.1	1.46	37.1	6.93	176.0	4.13	104.9	.56	14.2
G20407-2024	20GS-24FLC45-037	7347-65655	1 1/4	31.8	2.50	63.5	1.46	37.1	6.93	176.0	4.13	104.9	.56	14.2



### Caterpillar Style O-Ring Flange - 60° Bent Tube

NOTE: These FLC flanges are designed with a thicker flange head. The .56" flange dimension is frequently found on Caterpillar equipment. These flanges let the user utilize the existing Caterpillar flange halves or new Gates Caterpillar flange halves. At the user's option, standard Code 62 flanges and halves can be used in place of Caterpillar flanges and halves. The standard Code 62 flange head thickness ranges between .305" and .495". Compatible with Code 62 O-Ring. See Accessories for recommended O-Rings. (Do Not use "D" shaped O-Rings).

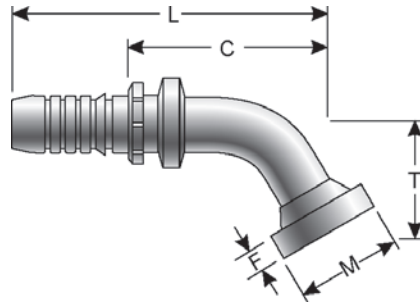

Part No.	Descr.	Prod. No.	⊖		M		T		L		C		F	
			"	mm	"	mm	"	mm	"	mm	"	mm	"	mm
G20409-1216	12GS-16FLC60-048	7347-66465	3/4	19.1	1.88	47.8	1.89	48.0	5.75	146.1	3.74	95.0	.56	14.2
G20409-1616	16GS-16FLC60-050	7347-66555	1	25.4	1.88	47.8	1.97	50.0	6.42	163.1	4.17	105.9	.56	14.2
G20409-1620	16GS-20FLC60-050	7347-66565	1	25.4	2.13	54.1	1.97	50.0	6.42	163.1	4.17	105.9	.56	14.2
G20409-2020	20GS-20FLC60-052	7347-66645	1 1/4	31.8	2.13	54.1	2.05	52.1	7.80	198.1	5.00	127.0	.56	14.2
G20409-2024	20GS-24FLC60-052	7347-66655	1 1/4	31.8	2.50	63.5	2.05	52.1	7.80	198.1	5.00	127.0	.56	14.2

### Caterpillar Style O-Ring Flange - 67 1/2° Bent Tube

NOTE: These FLC flanges are designed with a thicker flange head. The .56" flange dimension is frequently found on Caterpillar equipment. These flanges let the user utilize the existing Caterpillar flange halves or new Gates Caterpillar flange halves. At the user's option, standard Code 62 flanges and halves can be used in place of Caterpillar flanges and halves. The standard Code 62 flange head thickness ranges between .305" and .495". Compatible with Code 62 O-Ring. See Accessories for recommended O-Rings. (Do Not use "D" shaped O-Rings).

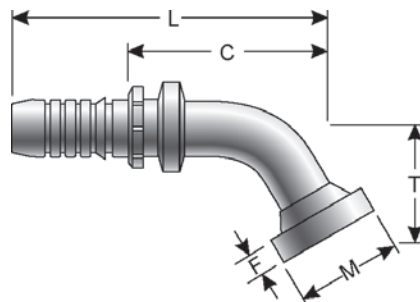

Part No.	Descr.	Prod. No.	⊖		M		T		L		C		F	
			"	mm	"	mm	"	mm	"	mm	"	mm	"	mm
G20410-1616	16GS-16FLC67-057	7347-67555	1	25.4	1.88	47.8	2.24	56.9	6.14	156.0	3.90	99.1	.56	14.2
G20410-1620	16GS-20FLC67-057	7347-67565	1	25.4	2.13	54.1	2.24	56.9	6.14	156.0	3.90	99.1	.56	14.2
G20410-2020	20GS-20FLC67-059	7347-67645	1 1/4	31.8	2.13	54.1	2.32	58.9	7.52	191.0	4.72	119.9	.56	14.2
G20410-2024	20GS-24FLC67-059	7347-67655	1 1/4	31.8	2.50	63.5	2.32	58.9	7.52	191.0	4.72	119.9	.56	14.2

- EQUIPMENT
- HOSE/CPLG. SELECTION
- G8K COUPLINGS
- GLOBALSPIRAL COUPLINGS
- STAINLESS STEEL SPIRAL
- MEGACRIMP COUPLINGS
- STAINLESS STEEL BRAID
- POWER CRIMP COUPLINGS
- FIELD ATTACHABLE G1 & G2 COUPLINGS
- FIELD ATTACHABLE C5 COUPLINGS
- C14 COUPLINGS
- GL COUPLINGS
- GLX COUPLINGS
- PCTS THERMOPLASTIC COUPLINGS
- POLARSEAL COUPLINGS (ACA)
- POLARSEAL II COUPLINGS (ACC)
- POLARSEAL II COUPLINGS (ACB)
- POWER STEERING
- ADAPTERS
- QUICK DISCONNECT COUPLERS
- BALL VALVES
- LIVE SWIVEL
- ASSEMBLY FABRICATION
- ACCESSORIES
- EQUIPMENT AND PARTS
- KITS
- AIR BRAKE HOSE ASSY
- BRASS



### Caterpillar Style O-Ring Flange - 90° Bent Tube

NOTE: These FLC flanges are designed with a thicker flange head. The .56" flange dimension is frequently found on Caterpillar equipment. These flanges let the user utilize the existing Caterpillar flange halves or new Gates Caterpillar flange halves. At the user's option, standard Code 62 flanges and halves can be used in place of Caterpillar flanges and halves. The standard Code 62 flange head thickness ranges between .305" and .495". Compatible with Code 62 O-Ring. See Accessories for recommended O-Rings. (Do Not use "D" shaped O-Rings).

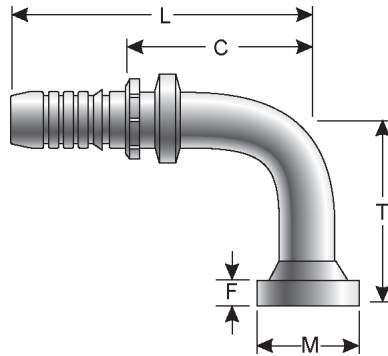

Part No.	Descr.	Prod. No.	⊖		M		T		L		C		F	
			"	mm	"	mm	"	mm	"	mm	"	mm	"	mm
G20415-1212	12GS-12FLC90-068	7347-73945	3/4	19.1	1.63	41.4	2.68	68.1	4.92	125.0	2.91	73.9	.56	14.2
G20416-1212	12GS-12FLC90-128	7347-76015	3/4	19.1	1.63	41.4	5.04	128.0	4.61	117.1	2.60	66.0	.56	14.2
G20415-1216	12GS-16FLC90-068	7347-73955	3/4	19.1	1.88	47.8	2.68	68.1	4.61	117.1	2.60	66.0	.56	14.2
G20415-1616	16GS-16FLC90-074	7347-68555	1	25.4	1.88	47.8	2.91	73.9	5.16	131.1	2.92	74.2	.56	14.2
G20416-1616	16GS-16FLC90-132	7347-73035	1	25.4	1.88	47.8	5.20	132.1	5.16	131.1	2.92	74.2	.56	14.2
G20415-1620	16GS-20FLC90-074	7347-68565	1	25.4	2.13	54.1	2.91	73.9	5.16	131.1	2.92	74.2	.56	14.2
G20416-1620	16GS-20FLC90-132	7347-68585	1	25.4	2.13	54.1	5.19	131.8	5.15	130.8	2.92	74.2	.56	14.2
G20415-2020	20GS-20FLC90-077	7347-68645	1 1/4	31.8	2.13	54.1	3.03	77.0	6.54	166.1	3.74	95.0	.56	14.2
G20416-2020	20GS-20FLC90-150	7347-68685	1 1/4	31.8	2.13	54.1	5.90	149.9	9.48	240.8	6.70	170.2	.56	14.2
G20415-2024	20GS-24FLC90-077	7347-68655	1 1/4	31.8	2.50	63.5	3.03	77.0	6.54	166.1	3.74	95.0	.56	14.2
G20416-2024	20GS-24FLC90-150	7347-68815	1 1/4	31.8	2.13	54.1	5.91	150.1	6.54	166.1	3.74	95.0	.56	14.2

### Female French GAZ (Poclair) 24° High Pressure Flange

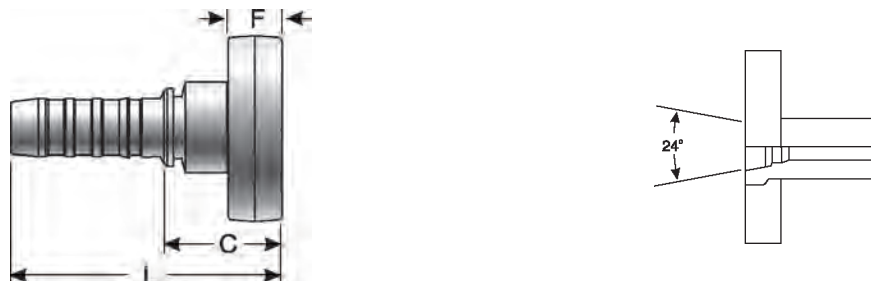

Part No.	Descr.	Prod. No.	⊖		L		C		F	
			"	mm	"	mm	"	mm	"	mm
G20420-0817	8GS-17FPFL	7347-93215	1/2	12.7	2.72	69.1	1.24	31.5	.56	14.2
G20420-1021	10GS-21FPFL	7347-92995	5/8	15.9	3.35	85.1	1.37	34.8	.56	14.2
G20420-1227	12GS-27FPFL	7347-93065	3/4	19.1	3.58	90.9	1.57	39.9	.56	14.2
G20420-1634	16GS-34FPFL	7347-93165	1	25.4	4.02	102.1	1.78	45.2	.56	14.2
G20420-2042	20GS-42FPFL	7347-93465	1 1/4	31.8	5.24	133.1	2.44	62.0	.56	14.2



### Male French GAZ (Poclain) 24° High Pressure Flange

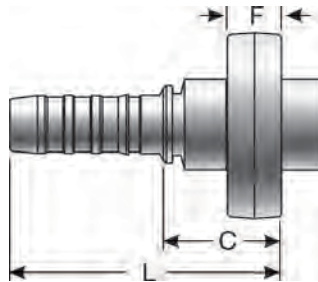

Part No.	Descr.	Prod. No.	⊖		L		C		F	
			"	mm	"	mm	"	mm	"	mm
G20480-0817	8GS-17MPFL	7347-93225	1/2	12.7	3.11	79.0	1.63	41.4	.56	14.2
G20480-1021	10GS-21MPFL	7347-93005	5/8	15.9	3.27	83.1	1.29	32.8	.56	14.2
G20480-1227	12GS-27MPFL	7347-93085	3/4	19.1	4.02	102.1	2.01	51.1	.56	14.2
G20480-1634	16GS-34MPFL	7347-93185	1	25.4	4.51	114.6	2.27	57.7	.56	14.2
G20480-2042	20GS-42MPFL	7347-93475	1 1/4	31.8	6.77	172.0	3.96	100.6	.56	14.2

### Male French GAZ (Poclain) 24° High Pressure Flange - 90° Bent Tube

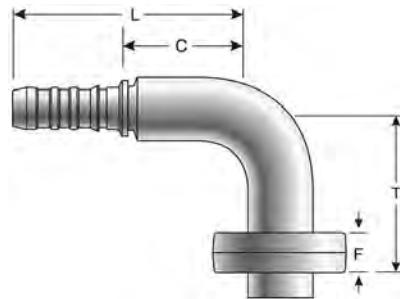

Part No.	Descr.	Prod. No.	⊖		T		L		C		F	
			"	mm	"	mm	"	mm	"	mm	"	mm
G20482-1021	10GS-21MPFL90	7347-93045	5/8	15.9	2.27	57.7	3.62	92.0	1.64	41.7	.56	14.2
G20482-2042	20GS-42MPFL90	7347-93485	1 1/4	31.8	3.51	89.2	5.90	149.9	3.09	78.5	.56	14.2

### Hose Length Extender Caterpillar

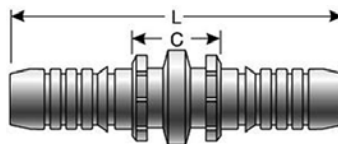

Part No.	Descr.	Prod. No.	⊖		L		C	
			"	mm	"	mm	"	mm
G20534-1212	12GS-12HLEC	7347-76405	3/4	19.1	6.42	163.1	2.40	61.0
G20534-1616	16GS-16HLEC	7347-76395	1	25.4	7.09	180.1	2.61	66.3

EQUIPMENT
HOSE/CPLG. SELECTION
G8K COUPLINGS
GLOBALSPIRAL COUPLINGS
STAINLESS STEEL SPIRAL
MEGACRIMP COUPLINGS
STAINLESS STEEL BRAID
POWER CRIMP COUPLINGS
FIELD ATTACHABLE G1 & G2 COUPLINGS
FIELD ATTACHABLE C5 COUPLINGS
C14 COUPLINGS
GL COUPLINGS
GLX COUPLINGS
PCTS THERMOPLASTIC COUPLINGS
POLARSEAL COUPLINGS (ACA)
POLARSEAL II COUPLINGS (ACC)
POLARSEAL II COUPLINGS (ACB)
POWER STEERING
ADAPTERS
QUICK DISCONNECT COUPLERS
BALL VALVES
LIVE SWIVEL
ASSEMBLY FABRICATION
ACCESSORIES
EQUIPMENT AND PARTS
KITS
AIR BRAKE HOSE ASSY
BRASS



EQUIPMENT
HOSE/CPLG. SELECTION
G8K COUPLINGS
<b>GLOBALSPIRAL COUPLINGS</b>
STAINLESS STEEL SPIRAL
MEGACRIMP COUPLINGS
STAINLESS STEEL BRAID
POWER CRIMP COUPLINGS
FIELD ATTACHABLE G1 & G2 COUPLINGS
FIELD ATTACHABLE C5 COUPLINGS
C14 COUPLINGS
GL COUPLINGS
GLX COUPLINGS
PCTS THERMOPLASTIC COUPLINGS
POLARSEAL COUPLINGS (ACA)
POLARSEAL II COUPLINGS (ACC)
POLARSEAL II COUPLINGS (ACB)
POWER STEERING
ADAPTERS
QUICK DISCONNECT COUPLERS
BALL VALVES
LIVE SWIVEL
ASSEMBLY FABRICATION
ACCESSORIES
EQUIPMENT AND PARTS
KITS
AIR BRAKE HOSE ASSY
BRASS

### Hose Length Extender

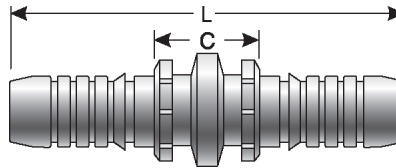

Part No.	Descr.	Prod. No.	⊖		L		C	
			"	mm	"	mm	"	mm
G20535-0808	8GS-8HLE	7347-73265	1/2	12.7	3.70	94.0	.75	19.1
G20535-1212	12GS-12HLE	7347-76815	3/4	19.1	4.80	121.9	.78	19.8
G20535-1616	16GS-16HLE	7347-76625	1	25.4	5.43	137.9	.98	24.9
G20535-2020	20GS-20HLE	7347-78585	1 1/4	31.8	6.77	172.0	1.17	29.7

### Hose Length Extender - 45° Bent Tube

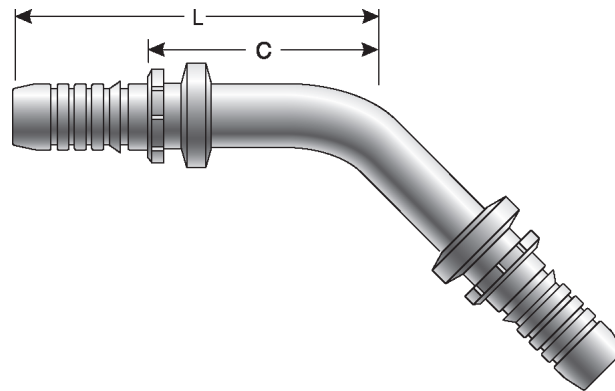

Part No.	Descr.	Prod. No.	⊖		L		C	
			"	mm	"	mm	"	mm
G20536-2020	20GS-20HLE45-103	7347-78895	1 1/4	31.8	9.80	248.9	6.19	157.2



### Hose Length Extender - 90° Bent Tube

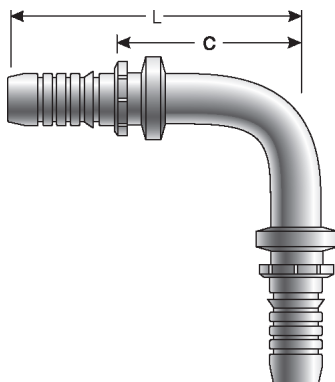

Part No.	Descr.	Prod. No.	⌀		L		C	
			"	mm	"	mm	"	mm
G20537-0808	8GS-8HLE90-086	7347-73195	1/2	12.7	3.39	86.1	1.91	48.5
G20537-1212	12GS-12HLE90	7347-73965	3/4	19.1	4.39	111.5	2.38	60.5
G20537-1616	16GS-16HLE90-127	7347-73705	1	25.4	5.00	127.0	2.76	70.1
G20537-2020	20GS-20HLE90-155	7347-76705	1 1/4	31.8	6.10	154.9	3.30	83.8

### Male DIN 24° Cone - Light Series

Do not use at a pressure above DIN Light ratings.  
Nut Hex per ISO Draft International Standards 12151-2.

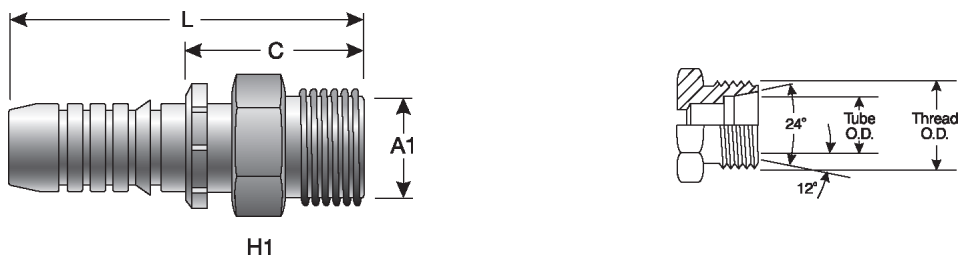

Part No.	Descr.	Prod. No.	⌀		H1	L		C		A1	
			"	mm		"	mm	"	mm		
G20615-0612	6GS-12MDL	7347-93445	3/8	9.5	M18X1.5	22	2.51	63.8	1.10	27.9	12.0
G20615-0815	8GS-15MDL	7347-90625	1/2	12.7	M22X1.5	24	2.48	63.0	1.00	25.4	15.0
G20615-1222	12GS-22MDL	7347-93565	3/4	19.1	M30X2.0	32	3.13	79.5	1.12	28.5	22.0
G20615-1628	16GS-28MDL	7347-91495	1	25.4	M36X2.0	41	3.54	89.9	1.31	33.3	28.0

- EQUIPMENT
- HOSE/CPLG. SELECTION
- G8K COUPLINGS
- GLOBALSPIRAL COUPLINGS
- STAINLESS STEEL SPIRAL
- MEGACRIMP COUPLINGS
- STAINLESS STEEL BRAID
- POWER CRIMP COUPLINGS
- FIELD ATTACHABLE G1 & G2 COUPLINGS
- FIELD ATTACHABLE C5 COUPLINGS
- C14 COUPLINGS
- GL COUPLINGS
- GLX COUPLINGS
- PCTS THERMOPLASTIC COUPLINGS
- POLARSEAL COUPLINGS (ACA)
- POLARSEAL II COUPLINGS (ACC)
- POLARSEAL II COUPLINGS (ACB)
- POWER STEERING
- ADAPTERS
- QUICK DISCONNECT COUPLERS
- BALL VALVES
- LIVE SWIVEL
- ASSEMBLY FABRICATION
- ACCESSORIES
- EQUIPMENT AND PARTS
- KITS
- AIR BRAKE HOSE ASSY
- BRASS





EQUIPMENT
HOSE/CPLG. SELECTION
G8K COUPLINGS
GLOBALSPIRAL COUPLINGS
STAINLESS STEEL SPIRAL
MEGACRIMP COUPLINGS
STAINLESS STEEL BRAID
POWER CRIMP COUPLINGS
FIELD ATTACHABLE G1 & G2 COUPLINGS
FIELD ATTACHABLE C5 COUPLINGS
C14 COUPLINGS
GL COUPLINGS
GLX COUPLINGS
PCTS THERMOPLASTIC COUPLINGS
POLARSEAL COUPLINGS (ACA)
POLARSEAL II COUPLINGS (ACC)
POLARSEAL II COUPLINGS (ACB)
POWER STEERING
ADAPTERS
QUICK DISCONNECT COUPLERS
BALL VALVES
LIVE SWIVEL
ASSEMBLY FABRICATION
ACCESSORIES
EQUIPMENT AND PARTS
KITS
AIR BRAKE HOSE ASSY
BRASS

## Female DIN 24° Cone Swivel - Light Series with O-Ring

Do not use at a pressure above DIN Light ratings.  
Nut Hex per ISO Draft International Standards 12151-2.

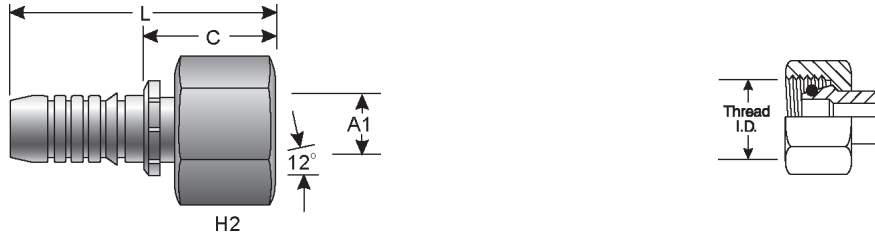

Part No.	Descr.	Prod. No.	⌀		H2	L		C		A1	
			"	mm		"	mm	"	mm		
G20645-0612	6GS-12FDLORX	7347-92815	3/8	9.5	M18X1.5	22	2.87	72.9	1.46	37.1	12.0
G20645-0815	8GS-15FDLORX	7347-90595	1/2	12.7	M22X1.5	22	2.87	72.9	1.40	35.6	15.0
G20645-1018	10GS-18FDLORX	7347-92105	5/8	15.9	M26X1.5	32	3.61	91.7	1.63	41.4	18.0
G20645-1222	12GS-22FDLORX	7347-92125	3/4	19.1	M30X2.0	36	3.82	97.0	1.81	46.0	22.0
G20645-1228	12GS-28FDLORX	7347-92165	3/4	19.1	M36X2.0	41	3.90	99.1	1.89	48.1	28.0
G20645-1628	16GS-28FDLORX	7347-90795	1	25.4	M36X2.0	41	4.13	104.9	1.91	48.5	28.0
G20645-2035	20GS-35FDLORX	7347-94135	1 1/4	31.8	M45X2.0	50	5.21	132.3	2.41	61.2	35.0

## Female DIN 24° Cone Swivel - Light Series with O-Ring - 45° Bent Tube

Do not use at a pressure above DIN Light ratings.  
Nut Hex per ISO Draft International Standards 12151-2.

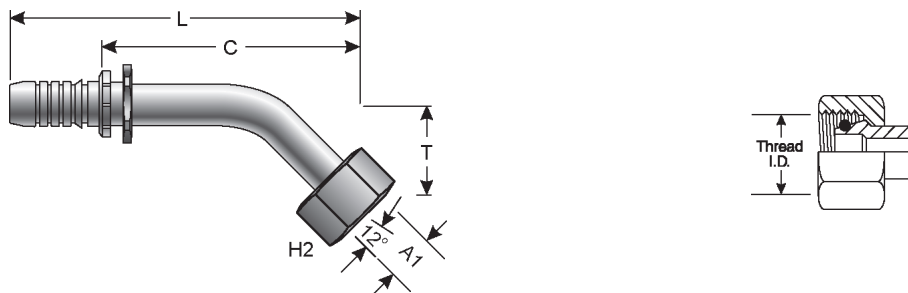

Part No.	Descr.	Prod. No.	⌀		H2	T		L		C		A1	
			"	mm		"	mm	"	mm	"	mm		
G20650-0815	8GS-15FDLORX45	7347-90605	1/2	12.7	M22X1.5	27	.79	20.1	3.72	94.5	2.25	57.2	15.0
G20650-1222	12GS-22FDLORX45	7347-92525	3/4	19.1	M30X2.0	36	1.17	29.7	5.35	135.9	3.34	84.8	22.0
G20650-1628	16GS-28FDLORX45	7347-91525	1	25.4	M36X2.0	41	1.21	30.7	6.12	155.5	3.90	99.1	28.0



## Female DIN 24° Cone Swivel - Light Series with O-Ring - 90° Bent Tube

Do not use at a pressure above DIN Light ratings.  
Nut Hex per ISO Draft International Standards 12151-2.

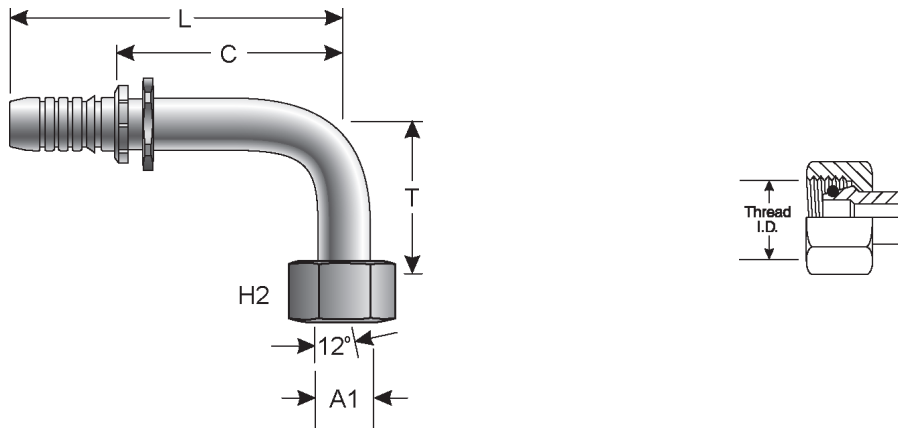

Part No.	Descr.	Prod. No.	⌀		H2	T	L		C		A1		
			"	mm			"	mm	"	mm		"	mm
G20655-0612	6GS-12FDLORX90	7347-92455	3/8	9.5	M18X1.5	22	1.45	36.8	3.07	78.0	1.66	42.2	12.0
G20655-0815	8GS-15FDLORX90	7347-90615	1/2	12.7	M22X1.5	27	1.65	41.9	3.46	87.9	1.98	50.3	15.0
G20655-1018	10GS-18FDLORX90	7347-92515	5/8	15.9	M26X1.5	32	2.03	51.6	4.47	113.5	2.49	63.3	18.0
G20655-1222	12GS-22FDLORX90M	7347-92135	3/4	19.1	M30X2.0	36	2.44	62.0	4.86	123.4	2.86	72.6	22.0
G20655-1628	16GS-28FDLORX90M	7347-90765	1	25.4	M36X2.0	41	2.76	70.1	5.82	147.8	2.71	68.8	28.0

## Male French GAZ

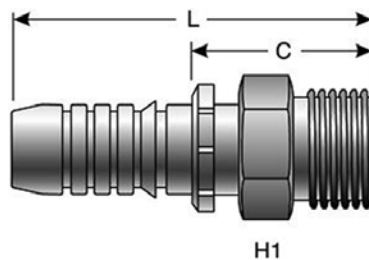

Part No.	Descr.	Prod. No.	⌀		H1	L		C		
			"	mm		"	mm	"	mm	
G20675-0817	8GS-17MFG	7347-90655	1/2	12.7	M24X1.5	26	2.61	66.3	1.14	29.0
G20675-1221	12GS-21MFG	7347-94075	3/4	19.1	M30X1.5	32	3.23	82.0	1.22	31.0
G20675-1227	12GS-27MFG	7347-93055	3/4	19.1	M36X1.5	42	3.33	84.6	1.32	33.5
G20675-1634	16GS-34MFG	7347-93155	1	25.4	M45X1.5	50	3.70	94.0	1.46	37.1

- EQUIPMENT
- HOSE/CPLG. SELECTION
- G8K COUPLINGS
- GLOBALSPIRAL COUPLINGS
- STAINLESS STEEL SPIRAL
- MEGACRIMP COUPLINGS
- STAINLESS STEEL BRAID
- POWER CRIMP COUPLINGS
- FIELD ATTACHABLE G1 & G2 COUPLINGS
- FIELD ATTACHABLE C5 COUPLINGS
- C14 COUPLINGS
- GL COUPLINGS
- GLX COUPLINGS
- PCTS THERMOPLASTIC COUPLINGS
- POLARSEAL COUPLINGS (ACA)
- POLARSEAL II COUPLINGS (ACC)
- POLARSEAL II COUPLINGS (ACB)
- POWER STEERING
- ADAPTERS
- QUICK DISCONNECT COUPLERS
- BALL VALVES
- LIVE SWIVEL
- ASSEMBLY FABRICATION
- ACCESSORIES
- EQUIPMENT AND PARTS
- KITS
- AIR BRAKE HOSE ASSY
- BRASS



EQUIPMENT
HOSE/CPLG. SELECTION
G8K COUPLINGS
GLOBALSPIRAL COUPLINGS
STAINLESS STEEL SPIRAL
MEGACRIMP COUPLINGS
STAINLESS STEEL BRAID
POWER CRIMP COUPLINGS
FIELD ATTACHABLE G1 & G2 COUPLINGS
FIELD ATTACHABLE C5 COUPLINGS
C14 COUPLINGS
GL COUPLINGS
GLX COUPLINGS
PCTS THERMOPLASTIC COUPLINGS
POLARSEAL COUPLINGS (ACA)
POLARSEAL II COUPLINGS (ACC)
POLARSEAL II COUPLINGS (ACB)
POWER STEERING
ADAPTERS
QUICK DISCONNECT COUPLERS
BALL VALVES
LIVE SWIVEL
ASSEMBLY FABRICATION
ACCESSORIES
EQUIPMENT AND PARTS
KITS
AIR BRAKE HOSE ASSY
BRASS

### Female French GAZ Swivel (Female Kobelco)

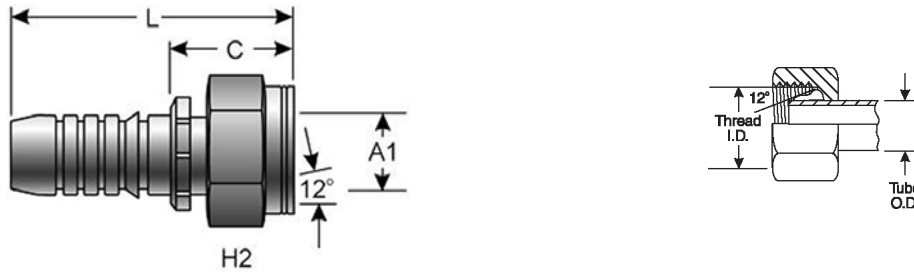

Part No.	Descr.	Prod. No.	⊖		H2	L		C		A1	
			"	mm		"	mm	"	mm		
G20680-0817	8GS-17FFGX	7347-90665	1/2	12.7	M24X1.5	30	2.68	68.1	1.20	30.5	16.8
G20680-1021	10GS-21FFGX	7347-93025	5/8	15.9	M30X1.5	36	3.44	87.4	1.44	36.6	21.3
G20680-1221	12GS-21FFGX	7347-94715	3/4	19.1	M30X1.5	36	3.27	83.1	1.29	32.8	21.3
G20680-1227	12GS-27FFGX	7347-93075	3/4	19.1	M36X1.5	41	3.41	86.6	1.40	35.6	26.6
G20680-1627	16GS-27FFGX	7347-94725	1	25.4	M36X1.5	41	3.41	86.6	1.40	35.6	26.6
G20680-1634	16GS-34FFGX	7347-93175	1	25.4	M45X1.5	55	3.76	95.5	1.54	39.1	33.5

### Female French GAZ Swivel - 90° Bent Tube (Female Kobelco)

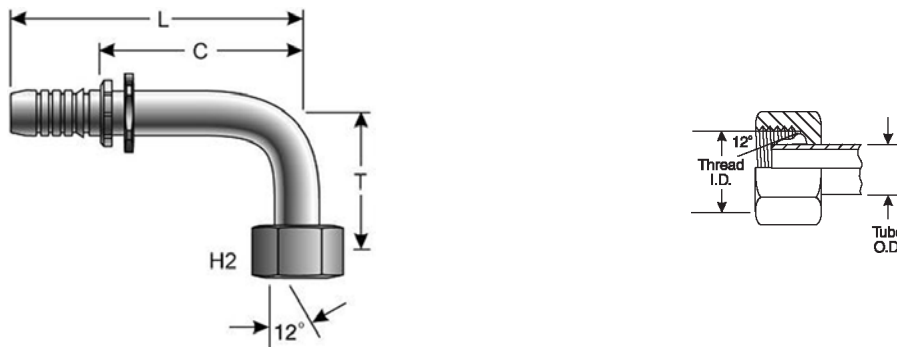

Part No.	Descr.	Prod. No.	⊖		H2	T		L		C		
			"	mm		"	mm	"	mm	"	mm	
G20690-1021	10GS-21FFGX90	7347-93035	5/8	15.9	M30X1.5	36	1.77	45.0	3.62	92.0	1.64	41.7
G20690-1221	12GS-21FFGX90	7347-94735	3/4	19.1	M30X1.5	36	2.00	50.8	4.91	124.7	2.90	73.7
G20691-1227	12GS5K-27FFGX90-060	7347-78645	3/4	19.1	M36X1.5	41	2.36	59.9	4.91	124.7	2.90	73.7
G20690-1627	16GS-27FFGX90	7347-94745	1	25.4	M36X1.5	41	2.64	67.1	5.94	150.9	3.72	94.5
G20691-1634	16GS5K-34FFGX90-065	7347-78655	1	25.4	M45X1.5	55	2.56	65.0	5.67	144.0	3.45	87.6



### Male DIN 24° Cone - Heavy Series

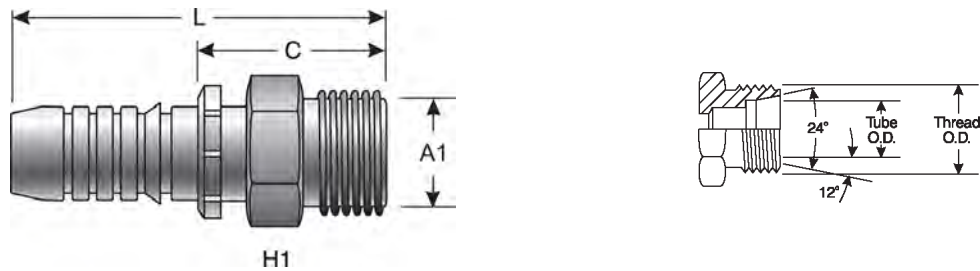

Part No.	Descr.	Prod. No.	⊖		H1	L		C		A1	
			"	mm		"	mm	"	mm		
G20715-0612	6GS-12MDH	7347-01785	3/8	9.5	M20X1.5	22	2.51	63.8	1.10	27.9	12.0
G20715-0614	6GS-14MDH	7347-92675	3/8	9.5	M22X1.5	24	2.59	65.8	1.18	30.0	14.0
G20715-0816	8GS-16MDH	7347-91325	1/2	12.7	M24X1.5	27	1.17	29.7	1.18	30.0	16.0
G20715-1020	10GS-20MDH	7347-92695	5/8	15.9	M30X2.0	32	3.35	85.1	1.37	34.8	20.0
G20715-1220	12GS-20MDH	7347-92255	3/4	19.1	M30X2.0	32	3.35	85.1	1.34	34.0	20.0
G20715-1225	12GS-25MDH	7347-92265	3/4	19.1	M36X2.0	41	3.50	88.9	1.50	38.1	25.0
G20715-1230	12GS-30MDH	7347-93765	3/4	19.1	M42X2.0	46	3.90	99.1	1.06	26.9	30.0
G20715-1625	16GS-25MDH	7347-91505	1	25.4	M36X2.0	41	3.82	97.0	1.58	40.1	25.0
G20715-1630	16GS-30MDH	7347-91515	1	25.4	M42X2.0	46	3.90	99.1	1.66	42.2	30.0
G20715-2038	20GS-38MDH	7347-93295	1 1/4	31.8	M52X2.0	55	4.84	122.9	2.04	51.8	38.0

### Female DIN 24° Cone Swivel - Heavy Series with O-Ring

Nut Hex per ISO Draft International Standards 12151-2.

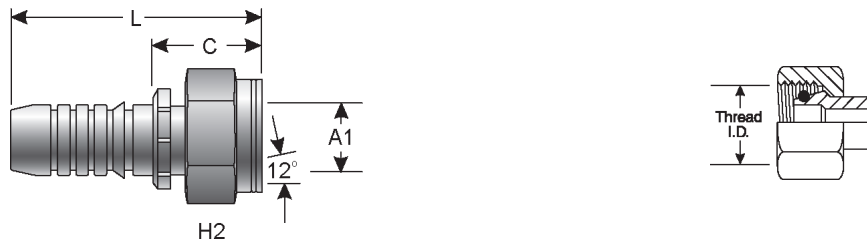

Part No.	Descr.	Prod. No.	⊖		H2	L		C		A1	
			"	mm		"	mm	"	mm		
G20720-0610	6GS-10FDHORX	7347-92635	3/8	9.5	M18X1.5	22	3.24	82.3	1.41	35.8	10.0
G20720-0612	6GS-12FDHORX	7347-92645	3/8	9.5	M20X1.5	24	2.87	72.9	1.46	37.1	12.0
G20720-0614	6GS-14FDHORX	7347-92085	3/8	9.5	M22X1.5	27	2.97	75.4	1.56	39.6	14.0
G20720-0812	8GS-12FDHORX	7347-95195	1/2	12.7	M20X1.5	24	2.87	72.9	1.53	38.9	12.0
G20720-0814	8GS-14FDHORX	7347-92095	1/2	12.7	M22X1.5	27	3.01	76.5	1.53	38.9	14.0
G20720-0816	8GS-16FDHORX	7347-91335	1/2	12.7	M24X1.5	30	3.11	79.0	1.63	41.4	16.0
G20720-0820	8GS-20FDHORX	7347-92715	1/2	12.7	M30X2.0	36	3.11	79.0	1.96	49.9	20.0
G20720-1020	10GS-20FDHORX	7347-92115	5/8	15.9	M30X2.0	36	3.94	100.1	1.96	49.9	20.0
G20720-1025	10GS-25FDHORX	7347-93425	5/8	15.9	M36X2.0	46	4.09	103.9	2.11	53.6	25.0
G20720-1220	12GS-20FDHORX	7347-92145	3/4	19.1	M30X2.0	36	4.06	103.1	2.05	52.1	20.0
G20720-1225	12GS-25FDHORX	7347-92155	3/4	19.1	M36X2.0	46	4.23	107.4	2.22	56.4	25.0
G20720-1625	16GS-25FDHORX	7347-91535	1	25.4	M36X2.0	46	4.57	116.1	2.35	59.7	25.0
G20720-1630	16GS-30FDHORX	7347-90805	1	25.4	M42X2.0	50	4.65	118.1	2.43	61.7	30.0
G20720-1638	16GS-38FDHORX	7347-94225	1	25.4	M52X2.0	60	4.40	111.8	2.17	55.1	38.0
G20720-2038	20GS-38FDHORX	7347-93305	1 1/4	31.8	M52X2.0	60	5.71	145.0	2.91	73.9	38.0

EQUIPMENT
HOSE/CPLG. SELECTION
G8K COUPLINGS
GLOBALSPIRAL COUPLINGS
STAINLESS STEEL SPIRAL
MEGACRIMP COUPLINGS
STAINLESS STEEL BRAID
POWER CRIMP COUPLINGS
FIELD ATTACHABLE G1 & G2 COUPLINGS
FIELD ATTACHABLE C5 COUPLINGS
C14 COUPLINGS
GL COUPLINGS
GLX COUPLINGS
PCTS THERMOPLASTIC COUPLINGS
POLARSEAL COUPLINGS (ACA)
POLARSEAL II COUPLINGS (ACC)
POLARSEAL II COUPLINGS (ACB)
POWER STEERING
ADAPTERS
QUICK DISCONNECT COUPLERS
BALL VALVES
LIVE SWIVEL
ASSEMBLY FABRICATION
ACCESSORIES
EQUIPMENT AND PARTS
KITS
AIR BRAKE HOSE ASSY
BRASS



EQUIPMENT
HOSE/CPLG. SELECTION
G8K COUPLINGS
GLOBALSPIRAL COUPLINGS
STAINLESS STEEL SPIRAL
MEGACRIMP COUPLINGS
STAINLESS STEEL BRAID
POWER CRIMP COUPLINGS
FIELD ATTACHABLE G1 & G2 COUPLINGS
FIELD ATTACHABLE C5 COUPLINGS
C14 COUPLINGS
GL COUPLINGS
GLX COUPLINGS
PCTS THERMOPLASTIC COUPLINGS
POLARSEAL COUPLINGS (ACA)
POLARSEAL II COUPLINGS (ACC)
POLARSEAL II COUPLINGS (ACB)
POWER STEERING
ADAPTERS
QUICK DISCONNECT COUPLERS
BALL VALVES
LIVE SWIVEL
ASSEMBLY FABRICATION
ACCESSORIES
EQUIPMENT AND PARTS
KITS
AIR BRAKE HOSE ASSY
BRASS

## Female DIN 24° Cone Swivel - Heavy Series with O-Ring - 45° Bent Tube

Nut Hex per ISO Draft International Standards 12151-2.

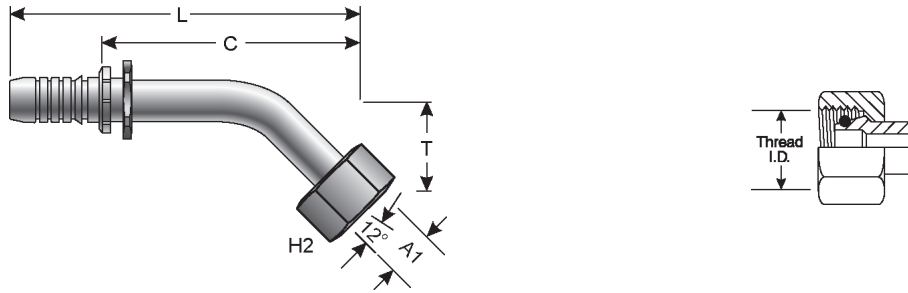

Part No.	Descr.	Prod. No.	⊖		H2	T		L		C		A1	
			"	mm		"	mm	"	mm	"	mm		
G20725-0612	6GS-12FDHORX45	7347-92425	3/8	9.5	M20X1.5	24	2.87	72.9	2.97	75.4	1.41	35.8	12.0
G20725-0614	6GS-14FDHORX45	7347-92465	3/8	9.5	M22X1.5	27	2.97	75.4	3.31	84.1	1.46	37.1	14.0
G20725-0816	8GS-16FDHORX45	7347-91345	1/2	12.7	M24X1.5	30	.85	21.6	3.70	94.0	2.23	56.6	16.0
G20725-1020	10GS-20FDHORX45	7347-92325	5/8	15.9	M30X2.0	36	.98	24.9	4.79	121.7	2.81	71.4	20.0
G20725-1220	12GS-20FDHORX45	7347-93285	3/4	19.1	M30X2.0	36	1.17	29.7	6.33	160.8	4.33	110.0	20.0
G20725-1225	12GS-25FDHORX45M	7347-92175	3/4	19.1	M36X2.0	46	1.23	31.2	5.31	134.9	3.40	86.4	25.0
G20725-1625	16GS-25FDHORX45M	7347-91545	1	25.4	M36X2.0	46	1.38	35.1	3.90	99.1	1.66	42.2	25.0
G20725-1630	16GS-30FDHORX45	7347-91565	1	25.4	M42X2.0	50	1.38	35.1	6.29	159.8	4.07	103.4	30.0
G20725-2038	20GS-38FDHORX45M	7347-93415	1 1/4	31.8	M52X2.0	60	1.67	42.4	7.72	196.1	4.92	125.0	38.0

## Female DIN 24° Cone Swivel - Heavy Series with O-Ring - 90° Bent Tube

Nut Hex per ISO Draft International Standards 12151-2.

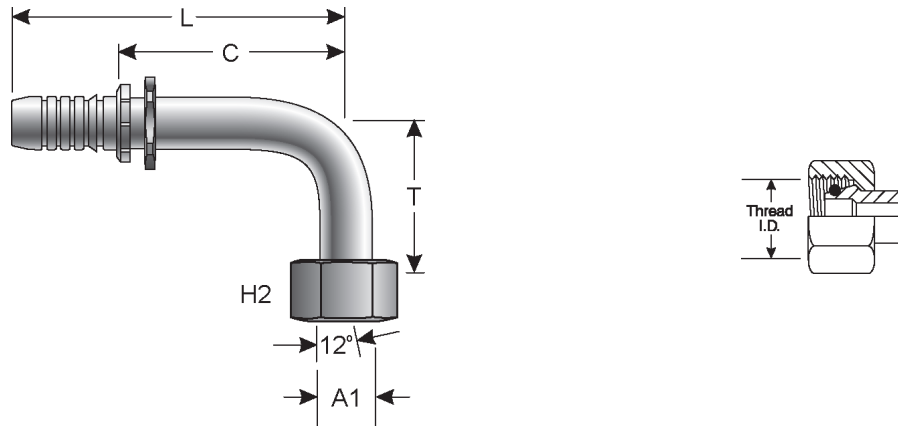

Part No.	Descr.	Prod. No.	⊖		H2	T		L		C		A1	
			"	mm		"	mm	"	mm	"	mm		
G20730-0612	6GS-12FDHORX90	7347-92435	3/8	9.5	M20X1.5	24	1.45	36.8	3.07	78.0	1.46	37.1	12.0
G20730-0614	6GS-14FDHORX90	7347-92475	3/8	9.5	M22X1.5	27	1.57	39.9	3.07	78.0	1.66	42.2	14.0
G20730-0816	8GS-16FDHORX90M	7347-91485	1/2	12.7	M24X1.5	30	1.73	43.9	3.39	86.1	1.91	48.5	16.0
G20730-1020	10GS-20FDHORX90M	7347-92335	5/8	15.9	M30X2.0	36	2.01	51.1	4.43	112.5	2.45	62.2	20.0
G20730-1220	12GS-20FDHORX90	7347-92185	3/4	19.1	M30X2.0	36	2.44	62.0	4.86	123.4	2.85	72.4	20.0
G20730-1225	12GS-25FDHORX90M	7347-92195	3/4	19.1	M36X2.0	46	2.52	64.0	4.86	123.4	2.85	72.4	25.0
G20730-1625	16GS-25FDHORX90	7347-91555	1	25.4	M36X2.0	46	2.99	76.0	5.94	150.9	3.72	94.5	25.0
G20730-1630	16GS-30FDHORX90M	7347-90775	1	25.4	M42X2.0	50	2.99	76.0	5.81	147.6	3.59	91.2	30.0



Female DIN 24° Cone Swivel - Heavy Series with O-Ring - 90° Bent Tube - Continued

Part No.	Descr.	Prod. No.	⊖		H2	T		L		C		A1	
			"	mm		"	mm	"	mm	"	mm		
G20730-2038	20GS-38FDHORX90M	7347-93315	1 1/4	31.8	M52X2.0	60	3.43	87.1	7.11	180.6	4.31	109.5	38.0

Male Kobelco (Male French GAZ)

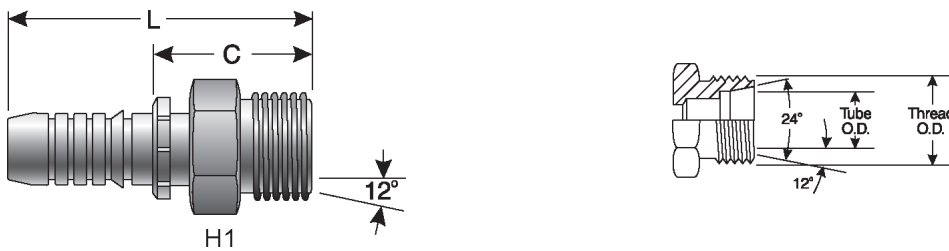

Part No.	Descr.	Prod. No.	⊖		H1	L		C		
			"	mm		"	mm	"	mm	
G20735-1222	12GS-22MKB	7347-73665	3/4	19.1	M30X1.5	36	3.35	85.1	1.34	34.0
G20735-1228	12GS-28MKB	7347-73675	3/4	19.1	M36X1.5	41	3.62	92.0	1.61	40.9
G20735-1628	16GS-28MKB	7347-73095	1	25.4	M36X1.5	50	3.98	101.1	1.74	44.2
G20735-1635	16GS-35MKB	7347-73025	1	25.4	M45X1.5	50	3.74	95.0	1.50	38.1

Male British Standard Pipe Parallel

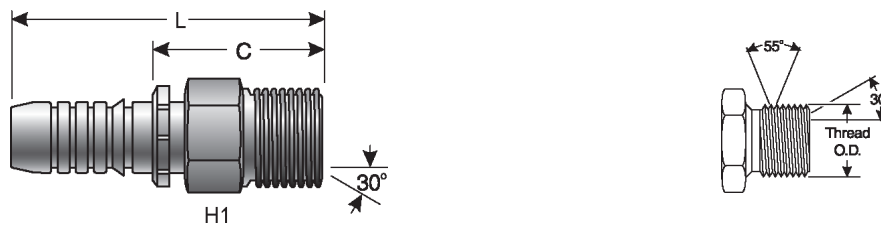

Part No.	Descr.	Prod. No.	⊖		H1	L		C		
			"	mm		"	mm	"	mm	
G20810-0606	6GS-6MBSPP	7347-01775	3/8	9.5	3/8-19	22	2.48	63.0	1.07	27.2
G20810-0808	8GS-8MBSPP	7347-91365	1/2	12.7	1/2-14	27	2.66	67.6	1.81	46.0
G20810-1010	10GS-10MBSPP	7347-92615	5/8	15.9	5/8-14	30	2.66	67.6	1.18	30.0
G20810-1012	10GS-12MBSPP	7347-92625	5/8	15.9	3/4-14	32	3.35	85.1	1.37	34.8
G20810-1212	12GS-12MBSPP	7347-92205	3/4	19.1	3/4-14	32	3.35	85.1	1.37	34.8
G20810-1616	16GS-16MBSPP	7347-90825	1	25.4	1-11	41	3.86	98.1	1.62	41.2
G20810-2020	20GS-20MBSPP	7347-93365	1 1/4	31.8	1 1/4-11	50	4.65	118.1	1.85	47.0

EQUIPMENT
HOSE/CPLG. SELECTION
G8K COUPLINGS
GLOBALSPIRAL COUPLINGS
STAINLESS STEEL SPIRAL
MEGACRIMP COUPLINGS
STAINLESS STEEL BRAID
POWER CRIMP COUPLINGS
FIELD ATTACHABLE G1 & G2 COUPLINGS
FIELD ATTACHABLE C5 COUPLINGS
C14 COUPLINGS
GL COUPLINGS
GLX COUPLINGS
PCTS THERMOPLASTIC COUPLINGS
POLARSEAL COUPLINGS (ACA)
POLARSEAL II COUPLINGS (ACC)
POLARSEAL II COUPLINGS (ACB)
POWER STEERING
ADAPTERS
QUICK DISCONNECT COUPLERS
BALL VALVES
LIVE SWIVEL
ASSEMBLY FABRICATION
ACCESSORIES
EQUIPMENT AND PARTS
KITS
AIR BRAKE HOSE ASSY
BRASS



EQUIPMENT
HOSE/CPLG. SELECTION
G8K COUPLINGS
<b>GLOBALSPIRAL COUPLINGS</b>
STAINLESS STEEL SPIRAL
MEGACRIMP COUPLINGS
STAINLESS STEEL BRAID
POWER CRIMP COUPLINGS
FIELD ATTACHABLE G1 & G2 COUPLINGS
FIELD ATTACHABLE C5 COUPLINGS
C14 COUPLINGS
GL COUPLINGS
GLX COUPLINGS
PCTS THERMOPLASTIC COUPLINGS
POLARSEAL COUPLINGS (ACA)
POLARSEAL II COUPLINGS (ACC)
POLARSEAL II COUPLINGS (ACB)
POWER STEERING
ADAPTERS
QUICK DISCONNECT COUPLERS
BALL VALVES
LIVE SWIVEL
ASSEMBLY FABRICATION
ACCESSORIES
EQUIPMENT AND PARTS
KITS
AIR BRAKE HOSE ASSY
BRASS

## Female British Standard Parallel Pipe O-Ring Swivel

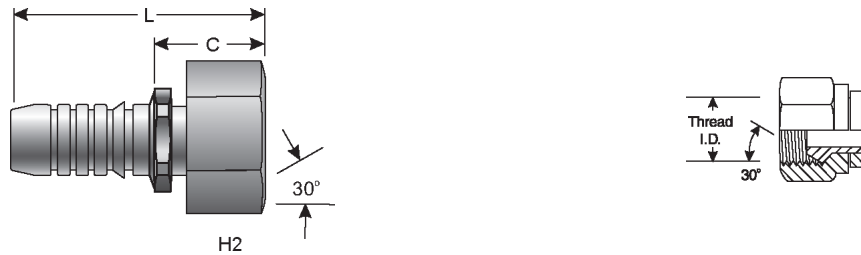

Part No.	Descr.	Prod. No.	⊖		H2	L		C		
			"	mm		"	mm	"	mm	
G20830-0606	6GS-6FBSPORX	7347-92235	3/8	9.5	3/8-19	22	2.34	59.4	.93	23.6
G20830-0608	6GS-8FBSPORX	7347-92705	3/8	9.5	1/2-14	27	2.40	61.0	.93	23.6
G20830-0808	8GS-8FBSPORX	7347-91405	1/2	12.7	1/2-14	27	2.40	61.0	.93	23.6
G20830-1010	10GS-10FBSPORX	7347-92405	5/8	15.9	5/8-14	30	3.35	85.1	1.18	30.0
G20830-1012	10GS-12FBSPORX	7347-93965	5/8	15.9	3/4-14	30	3.35	85.1	1.37	34.8
G20830-1212	12GS-12FBSPORX	7347-93995	3/4	19.1	3/4-14	32	3.41	86.6	1.40	35.6
G20830-1216	12GS-16FBSPORX	7347-92585	3/4	19.1	1-11	41	3.74	95.0	1.40	35.6
G20830-1616	16GS-16FBSPORX	7347-90815	1	25.4	1-11	41	3.74	95.0	1.52	38.6
G20830-1620	16GS-20FBSPORX	7347-94195	1	25.4	1 1/4-11	50	3.27	83.1	1.03	26.2
G20830-2020	20GS-20FBSPORX	7347-93375	1 1/4	31.8	1 1/4-11	50	4.59	116.6	1.79	45.5

## Female British Standard Parallel Pipe O-Ring Swivel - 45° Bent Tube

S, M and L Drops and Hex per ISO Working Draft 12151-6.

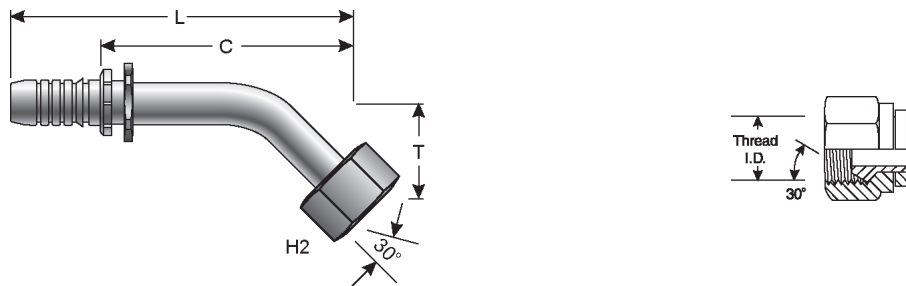

Part No.	Descr.	Prod. No.	⊖		H2	T		L		C		
			"	mm		"	mm	"	mm	"	mm	
G20831-0606	6GS-6FBSPORX45	7347-92345	3/8	9.5	3/8-19	22	.61	15.5	3.27	83.1	1.86	47.2
G20831-0808	8GS-8FBSPORX45M	7347-91415	1/2	12.7	1/2-14	27	.67	17.0	3.60	91.4	2.13	54.1
G20831-1010	10GS-10FBSPORX45	7347-92285	5/8	15.9	5/8-14	30	1.04	26.4	4.20	106.7	2.25	57.2
G20831-1212	12GS-12FBSPORX45	7347-94005	3/4	19.1	3/4-14	32	1.11	28.3	5.22	132.6	3.21	81.6
G20831-1616	16GS-16FBSPORX45M	7347-92275	1	25.4	1-11	41	1.22	31.0	6.12	155.5	3.90	99.1
G20831-2020	20GS-20FBSPORX45M	7347-93395	1 1/4	31.8	1 1/4-11	50	1.48	37.6	7.52	191.0	4.72	119.9



## Female British Standard Parallel Pipe O-Ring Swivel - 90° Bent Tube

S, M and L Drops and Hex per ISO Working Draft 12151-6.

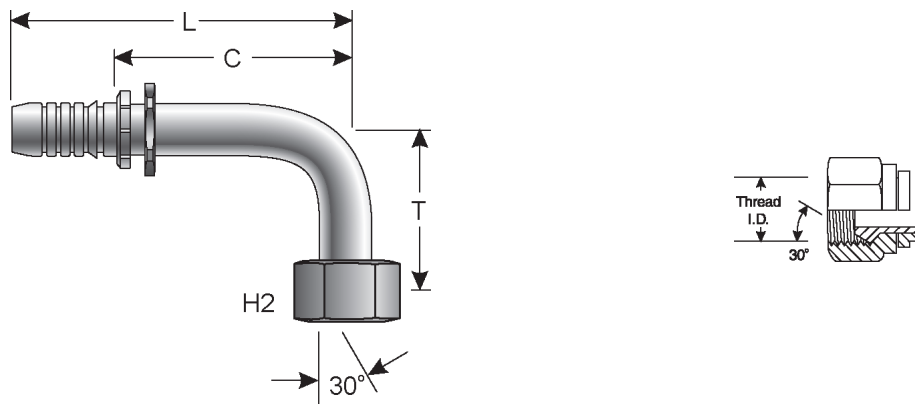

Part No.	Descr.	Prod. No.	⊖		H2	T		L		C		
			"	mm		"	mm	"	mm	"	mm	"
G20832-0606	6GS-6FBSPORX90	7347-92355	3/8	9.5	3/8-19	22	1.26	32.0	3.07	78.0	1.66	42.2
G20832-0808	8GS-8FBSPORX90M	7347-91425	1/2	12.7	1/2-14	27	1.48	37.6	3.46	87.9	1.99	50.6
G20832-1010	10GS-10FBSPORX90	7347-92295	5/8	15.9	5/8-14	30	1.90	48.3	4.70	119.4	2.45	62.2
G20832-1212	12GS-12FBSPORX90	7347-94015	3/4	19.1	3/4-14	30	2.36	60.0	4.90	124.2	2.88	73.2
G20832-1616	16GS-16FBSPORX90	7347-90785	1	25.4	1-11	41	2.76	70.1	5.81	147.6	3.59	91.2
G20832-2020	20GS-20FBSPORX90M	7347-93405	1 1/4	31.8	1 1/4-11	50	3.15	80.0	7.11	180.6	4.31	109.5

## Female British Standard Parallel Pipe O-Ring Swivel - 90° Block



Part No.	Descr.	Prod. No.	⊖		H2	T		L		C		
			"	mm		"	mm	"	mm	"	mm	
G20845-1212	12GS-12FBSPORX90BL	7347-93955	3/4	19.1	3/4-14	32	1.53	38.9	3.07	78.0	1.06	26.9

- EQUIPMENT
- HOSE/CPLG. SELECTION
- G8K COUPLINGS
- GLOBALSPIRAL COUPLINGS
- STAINLESS STEEL SPIRAL
- MEGACRIMP COUPLINGS
- STAINLESS STEEL BRAID
- POWER CRIMP COUPLINGS
- FIELD ATTACHABLE G1 & G2 COUPLINGS
- FIELD ATTACHABLE C5 COUPLINGS
- C14 COUPLINGS
- GL COUPLINGS
- GLX COUPLINGS
- PCTS THERMOPLASTIC COUPLINGS
- POLARSEAL COUPLINGS (ACA)
- POLARSEAL II COUPLINGS (ACC)
- POLARSEAL II COUPLINGS (ACB)
- POWER STEERING
- ADAPTERS
- QUICK DISCONNECT COUPLERS
- BALL VALVES
- LIVE SWIVEL
- ASSEMBLY FABRICATION
- ACCESSORIES
- EQUIPMENT AND PARTS
- KITS
- AIR BRAKE HOSE ASSY
- BRASS

EQUIPMENT
HOSE/CPLG. SELECTION
G8K COUPLINGS
GLOBALSPIRAL COUPLINGS
STAINLESS STEEL SPIRAL
MEGACRIMP COUPLINGS
STAINLESS STEEL BRAID
POWER CRIMP COUPLINGS
FIELD ATTACHABLE G1 & G2 COUPLINGS
FIELD ATTACHABLE C5 COUPLINGS
C14 COUPLINGS
GL COUPLINGS
GLX COUPLINGS
PCTS THERMOPLASTIC COUPLINGS
POLARSEAL COUPLINGS (ACA)
POLARSEAL II COUPLINGS (ACC)
POLARSEAL II COUPLINGS (ACB)
POWER STEERING
ADAPTERS
QUICK DISCONNECT COUPLERS
BALL VALVES
LIVE SWIVEL
ASSEMBLY FABRICATION
ACCESSORIES
EQUIPMENT AND PARTS
KITS
AIR BRAKE HOSE ASSY
BRASS

## Female British Flat-Face Swivel

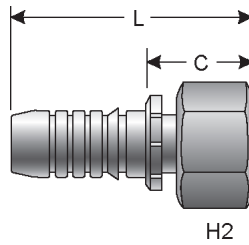

Part No.	Descr.	Prod. No.	⊖			H2	L		C	
			"	mm	"	mm	"	mm	"	mm
G20855-1616	16GS-16FBFFX	7347-78915	1	25.4	1-11	41	3.78	96.0	1.56	39.6

## Female Komatsu Style Japanese Metric Swivel

These female swivels have been marked with two small notches on the hex to identify them as the Komatsu style.

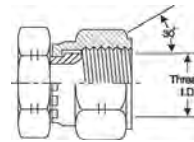
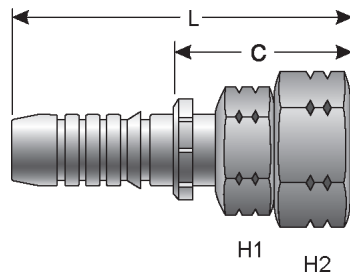

Part No.	Descr.	Prod. No.	⊖			H1	H2	L		C	
			"	mm	"	mm	mm	"	mm	"	mm
G20910-0808	8GS-8FKX	7347-35245	1/2	12.7	M22X1.5	27	27	2.93	74.4	1.46	37.1
G20910-1010	10GS-10FKX	7347-35345	5/8	15.9	M24X1.5	30	32	3.74	95.0	1.76	44.7
G20910-1212	12GS-12FKX	7347-35445	3/4	19.1	M30X1.5	32	36	4.00	101.6	2.00	50.8
G20910-1616	16GS-16FKX	7347-35555	1	25.4	M33X1.5	41	41	4.51	114.6	2.29	58.2

## Female Japanese Industrial Standard 30° Flare Swivel

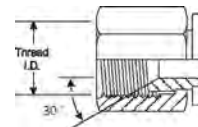
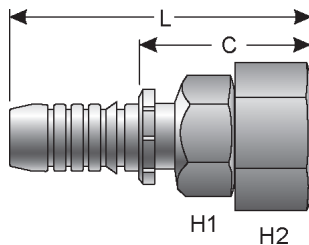

Part No.	Descr.	Prod. No.	⊖			H1	H2	L		C	
			"	mm	"	mm	mm	"	mm	"	mm
G20930-1212	12GS-12FJISX	7347-76195	3/4	19.1	3/4-14	32	36	3.87	98.3	1.86	47.2
G20930-1616	16GS-16FJISX	7347-76005	1	25.4	1-11	41	41	4.25	108.0	2.03	51.6



Female Japanese Industrial Standard 30° Flare Swivel - Continued

Part No.	Descr.	Prod. No.	⊖		H1	H2	L		C		
			"	mm			"	mm	"	mm	
G20930-2020	20GS-20FJISX	7347-76235	1 1/4	31.8	1 1/4-11	27	50	5.35	135.9	2.56	65.0

GS Ferrule for Wire Braid Hose

Consult eCrimp for wire braid types and sizes.

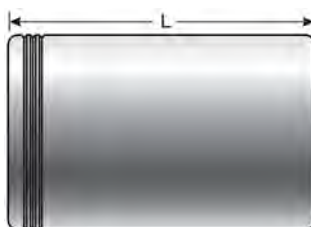

Part No.	Descr.	Prod. No.	⊖		L		⊕	
			"	mm	"	mm	"	mm
G20995-0106	6GS1F-1	7347-02875	3/8	9.5	1.20	30.5	.96	24.4
G20995-0206	6GS1F-2	7347-02945	3/8	9.5	1.20	30.5	1.06	26.9
G20995-0208	8GS1F-2	7347-02955	1/2	12.7	1.47	37.3	1.15	29.2
G20995-0210	10GS1F-2	7347-02965	5/8	15.9	1.40	35.6	1.33	33.8
G20995-0212	12GS1F-2	7347-02975	3/4	19.1	1.73	44.0	1.57	39.9
G20995-0216	16GS1F-2	7347-02985	1	25.4	2.06	52.3	1.94	49.3
G20995-0220	20GS1F-2	7347-02995	1 1/4	31.8	2.41	61.2	2.37	60.2

GS Ferrule for 4-Spiral Hose

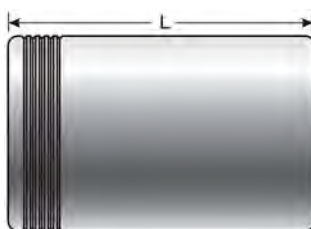

Part No.	Descr.	Prod. No.	⊖		L		⊕	
			"	mm	"	mm	"	mm
G20995-0406	6GS1F-4	7347-03105	3/8	9.5	1.43	36.3	1.25	31.8
G20995-0408	8GS1F-4	7347-03115	1/2	12.7	1.44	36.9	1.35	34.3
G20995-0410	10GS1F-4	7347-03125	5/8	15.9	1.88	47.8	1.64	41.7
G20995-0412	12GS1F-4	7347-03135	3/4	19.1	2.00	50.8	1.80	45.7
G20995-0416	16GS1F-4	7347-03145	1	25.4	2.22	56.4	2.07	52.6
G20995-0420	20GS1F-4	7347-03155	1 1/4	31.8	2.67	67.8	2.42	61.5

EQUIPMENT
HOSE/CPLG. SELECTION
G8K COUPLINGS
GLOBALSPIRAL COUPLINGS
STAINLESS STEEL SPIRAL
MEGACRIMP COUPLINGS
STAINLESS STEEL BRAID
POWER CRIMP COUPLINGS
FIELD ATTACHABLE G1 & G2 COUPLINGS
FIELD ATTACHABLE C5 COUPLINGS
C14 COUPLINGS
GL COUPLINGS
GLX COUPLINGS
PCTS THERMOPLASTIC COUPLINGS
POLARSEAL COUPLINGS (ACA)
POLARSEAL II COUPLINGS (ACC)
POLARSEAL II COUPLINGS (ACB)
POWER STEERING
ADAPTERS
QUICK DISCONNECT COUPLERS
BALL VALVES
LIVE SWIVEL
ASSEMBLY FABRICATION
ACCESSORIES
EQUIPMENT AND PARTS
KITS
AIR BRAKE HOSE ASSY
BRASS

EQUIPMENT
HOSE/CPLG. SELECTION
G8K COUPLINGS
<b>GLOBALSPIRAL COUPLINGS</b>
STAINLESS STEEL SPIRAL
MEGACRIMP COUPLINGS
STAINLESS STEEL BRAID
POWER CRIMP COUPLINGS
FIELD ATTACHABLE G1 & G2 COUPLINGS
FIELD ATTACHABLE C5 COUPLINGS
C14 COUPLINGS
GL COUPLINGS
GLX COUPLINGS
PCTS THERMOPLASTIC COUPLINGS
POLARSEAL COUPLINGS (ACA)
POLARSEAL II COUPLINGS (ACC)
POLARSEAL II COUPLINGS (ACB)
POWER STEERING
ADAPTERS
QUICK DISCONNECT COUPLERS
BALL VALVES
LIVE SWIVEL
ASSEMBLY FABRICATION
ACCESSORIES
EQUIPMENT AND PARTS
KITS
AIR BRAKE HOSE ASSY
BRASS

### GS Ferrule for 6-Spiral Hose

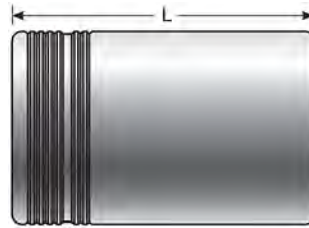

Part No.	Descr.	Prod. No.	⊖		L		⊖	
			"	mm	"	mm	"	mm
G20995-0620	20GS1F-6	7347-02905	1 1/4	31.8	2.87	72.9	2.67	67.8

### GS Ferrule for ID5K Hose

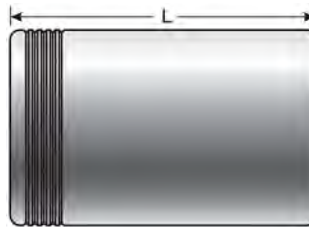

Part No.	Descr.	Prod. No.	⊖		L		⊖	
			"	mm	"	mm	"	mm
G20997-0408	8GSID1F-4	7347-85915	1/2	12.7	1.46	37.0	1.21	30.7
G20997-0410	10GSID1F-4	7347-85925	5/8	15.9	1.81	46.0	1.43	36.3
G20997-0412	12GSID1F-4	7347-85935	3/4	19.1	2.01	51.1	1.59	40.4
G20997-0416	16GSID1F-4	7347-85945	1	25.4	2.01	51.1	1.92	48.8

### 1 1/4" Special One-Piece Couplings - Male Pipe (NPTF - 30° Cone Seat)

MGS Couplings for use with MC4-20 Crimper Only.

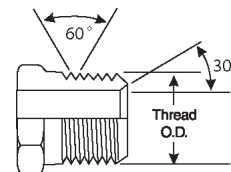
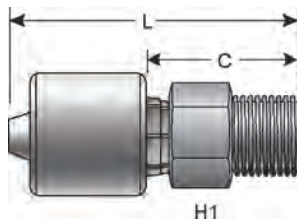

Part No.	Descr.	Prod. No.	⊖			H1	L		C	
			"	mm	"	"	mm	"	mm	
G21100-2020	20MGS-20MP	7347-86005	1 1/4	31.8	1 1/4-11 1/2	1 3/4	5.00	127.0	2.20	55.9



## 1 1/4" Special One-Piece Couplings - Male JIC 37° Flare

MGS Couplings for use with MC4-20 Crimper Only.

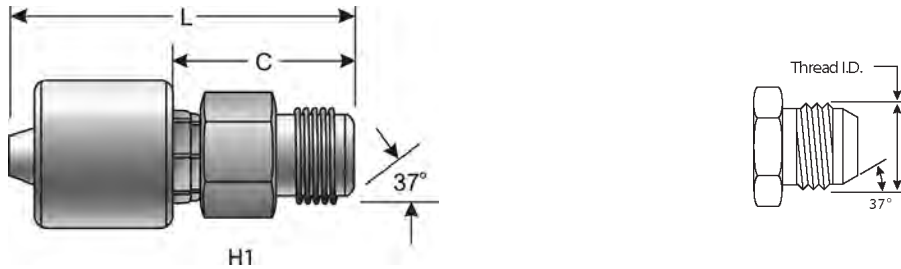

Part No.	Descr.	Prod. No.	⌀		H1	L		C		
			"	mm		"	mm	"	mm	
G21165-2020	20MGS-20MJ	7347-86015	1 1/4	31.8	1 5/8-12	1 3/4	4.92	125.0	2.12	53.9

## 1 1/4" Special One-Piece Couplings - Female JIC 37° Flare Swivel

MGS Couplings for use with MC4-20 Crimper Only.



Part No.	Descr.	Prod. No.	⌀		H1	H2	L		C		
			"	mm			"	mm	"	mm	
G21170-2020	20MGS-20FJX	7347-86025	1 1/4	31.8	1 5/8-12	1 7/8	2	5.35	135.9	2.56	65.0

- EQUIPMENT
- HOSE/CPLG. SELECTION
- G8K COUPLINGS
- GLOBALSPIRAL COUPLINGS
- STAINLESS STEEL SPIRAL
- MEGACRIMP COUPLINGS
- STAINLESS STEEL BRAID
- POWER CRIMP COUPLINGS
- FIELD ATTACHABLE G1 & G2 COUPLINGS
- FIELD ATTACHABLE C5 COUPLINGS
- C14 COUPLINGS
- GL COUPLINGS
- GLX COUPLINGS
- PCTS THERMOPLASTIC COUPLINGS
- POLARSEAL COUPLINGS (ACA)
- POLARSEAL II COUPLINGS (ACC)
- POLARSEAL II COUPLINGS (ACB)
- POWER STEERING
- ADAPTERS
- QUICK DISCONNECT COUPLERS
- BALL VALVES
- LIVE SWIVEL
- ASSEMBLY FABRICATION
- ACCESSORIES
- EQUIPMENT AND PARTS
- KITS
- AIR BRAKE HOSE ASSY
- BRASS





EQUIPMENT
HOSE/CPLG. SELECTION
G8K COUPLINGS
GLOBALSPIRAL COUPLINGS
STAINLESS STEEL SPIRAL
MEGACRIMP COUPLINGS
STAINLESS STEEL BRAID
POWER CRIMP COUPLINGS
FIELD ATTACHABLE G1 & G2 COUPLINGS
FIELD ATTACHABLE C5 COUPLINGS
C14 COUPLINGS
GL COUPLINGS
GLX COUPLINGS
PCTS THERMOPLASTIC COUPLINGS
POLARSEAL COUPLINGS (ACA)
POLARSEAL II COUPLINGS (ACC)
POLARSEAL II COUPLINGS (ACB)
POWER STEERING
ADAPTERS
QUICK DISCONNECT COUPLERS
BALL VALVES
LIVE SWIVEL
ASSEMBLY FABRICATION
ACCESSORIES
EQUIPMENT AND PARTS
KITS
AIR BRAKE HOSE ASSY
BRASS

## 1 1/4" Special One-Piece Couplings - Female JIC 37° Flare Swivel - 90° Bent Tube

MGS Couplings for use with MC4-20 Crimper Only.

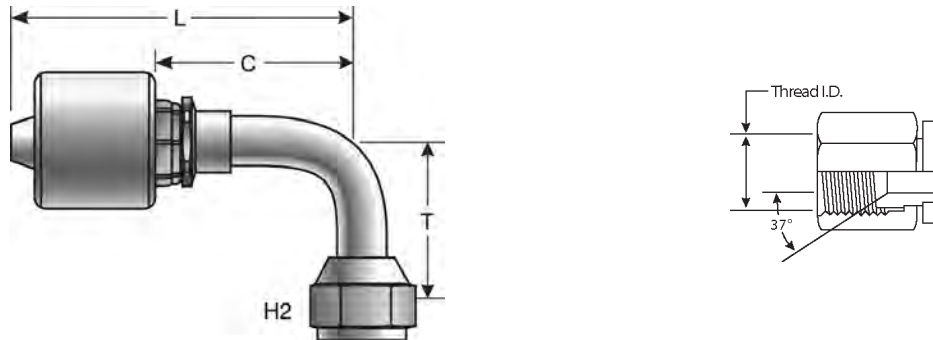

Part No.	Descr.	Prod. No.	⊖		H2	T		L		C		
			"	mm		"	mm	"	mm	"	mm	
G21180-2020	20MGS-20FJX90M-078	7347-86035	1 1/4	31.8	1 5/8-12	2	3.07	78.0	6.85	174.0	4.05	102.9

## 1 1/4" Special One-Piece Couplings - Female Flat-Face O-Ring Swivel

MGS Couplings for use with MC4-20 Crimper Only.

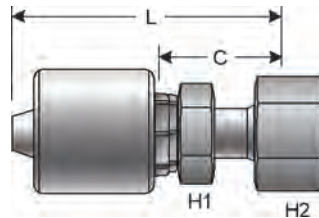

Part No.	Descr.	Prod. No.	⊖		H1	H2	L		C		
			"	mm			"	mm	"	mm	
G21230-2020	20MGS-20FFORX	7347-86045	1 1/4	31.8	1 11/16-12	50	50	5.04	128.0	2.24	56.9



## 1 1/4" Special One-Piece Couplings - Female Flat-Face O-Ring Swivel - 90° Bent Tube

MGS Couplings for use with MC4-20 Crimper Only.

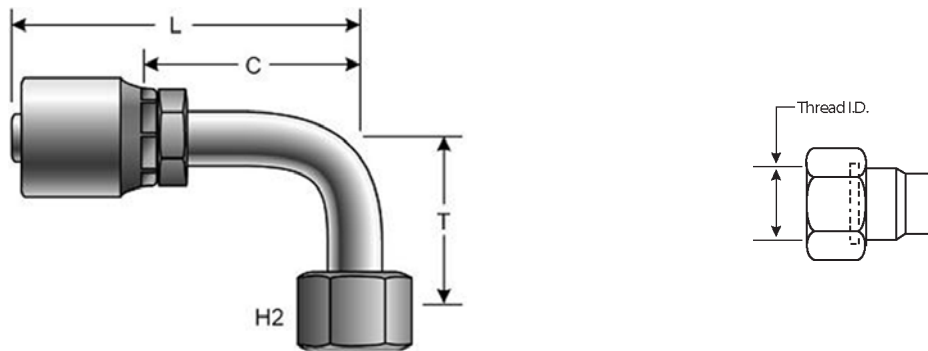

Part No.	Descr.	Prod. No.	⌀		H2		T		L		C	
			"	mm	"	mm	"	mm	"	mm	"	mm
G21240-2020	20MGS-20FFORX90M	7347-86055	1 1/4	31.8	1 11/16-12	50	3.07	78.0	6.77	172.0	3.97	100.8

## 1 1/4" Special One-Piece Couplings - Code 61 O-Ring Flange

MGS Couplings for use with MC4-20 Crimper Only.

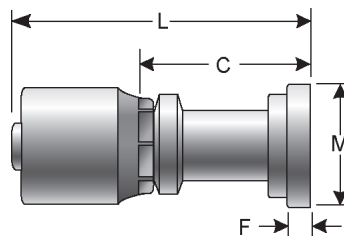

Part No.	Descr.	Prod. No.	⌀		M		L		C		F	
			"	mm	"	mm	"	mm	"	mm	"	mm
G21300-2020	20MGS-20FL	7347-86065	1 1/4	31.8	2.00	50.8	5.75	146.1	2.95	74.9	.32	8.1

- EQUIPMENT
- HOSE/CPLG. SELECTION
- G8K COUPLINGS
- GLOBALSPIRAL COUPLINGS
- STAINLESS STEEL SPIRAL
- MEGACRIMP COUPLINGS
- STAINLESS STEEL BRAID
- POWER CRIMP COUPLINGS
- FIELD ATTACHABLE G1 & G2 COUPLINGS
- FIELD ATTACHABLE C5 COUPLINGS
- C14 COUPLINGS
- GL COUPLINGS
- GLX COUPLINGS
- PCTS THERMOPLASTIC COUPLINGS
- POLARSEAL COUPLINGS (ACA)
- POLARSEAL II COUPLINGS (ACC)
- POLARSEAL II COUPLINGS (ACB)
- POWER STEERING
- ADAPTERS
- QUICK DISCONNECT COUPLERS
- BALL VALVES
- LIVE SWIVEL
- ASSEMBLY FABRICATION
- ACCESSORIES
- EQUIPMENT AND PARTS
- KITS
- AIR BRAKE HOSE ASSY
- BRASS

EQUIPMENT
HOSE/CPLG. SELECTION
G8K COUPLINGS
GLOBALSPIRAL COUPLINGS
STAINLESS STEEL SPIRAL
MEGACRIMP COUPLINGS
STAINLESS STEEL BRAID
POWER CRIMP COUPLINGS
FIELD ATTACHABLE G1 & G2 COUPLINGS
FIELD ATTACHABLE C5 COUPLINGS
C14 COUPLINGS
GL COUPLINGS
GLX COUPLINGS
PCTS THERMOPLASTIC COUPLINGS
POLARSEAL COUPLINGS (ACA)
POLARSEAL II COUPLINGS (ACC)
POLARSEAL II COUPLINGS (ACB)
POWER STEERING
ADAPTERS
QUICK DISCONNECT COUPLERS
BALL VALVES
LIVE SWIVEL
ASSEMBLY FABRICATION
ACCESSORIES
EQUIPMENT AND PARTS
KITS
AIR BRAKE HOSE ASSY
BRASS

## 1 1/4" Special One-Piece Couplings - Code 61 O-Ring Flange - 45° Bent Tube

MGS Couplings for use with MC4-20 Crimper Only.

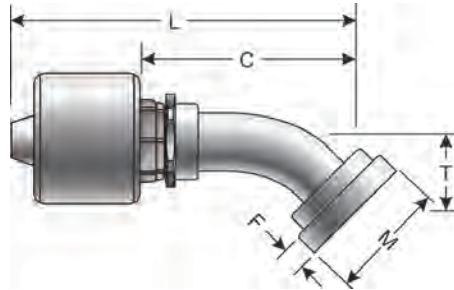

Part No.	Descr.	Prod. No.	⊖		M		T		L		C		F	
			"	mm	"	mm	"	mm	"	mm	"	mm	"	mm
G21307-2020	20MGS-20FL45S-032	7347-86075	1 1/4	31.8	2.00	50.8	1.26	32.0	6.69	169.9	3.89	98.8	.32	8.1

## 1 1/4" Special One-Piece Couplings - Code 61 O-Ring Flange - 90° Bent Tube

MGS Couplings for use with MC4-20 Crimper Only.

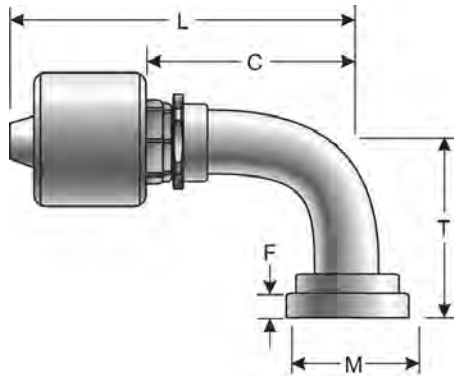

Part No.	Descr.	Prod. No.	⊖		M		T		L		C		F	
			"	mm	"	mm	"	mm	"	mm	"	mm	"	mm
G21315-2020	20MGS-20FL90M-090	7347-86085	1 1/4	31.8	2.00	50.8	3.54	89.9	6.54	166.1	3.74	95.0	.32	8.1



## 1 1/4" Special One-Piece Couplings - Code 62 O-Ring Flange

MGS Couplings for use with MC4-20 Crimper Only.

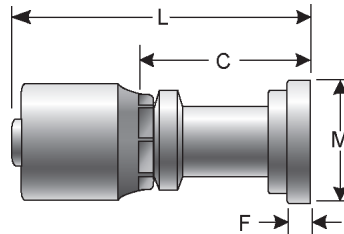

Part No.	Descr.	Prod. No.	⌀		M		L		C		F	
			"	mm	"	mm	"	mm	"	mm	"	mm
G21350-2020	20MGS-20FLH	7347-86135	1 1/4	31.8	2.13	54.1	5.75	146.1	2.95	74.9	.41	10.4

## 1 1/4" Special One-Piece Couplings - Male DIN 24° Cone - Heavy Series

MGS Couplings for use with MC4-20 Crimper Only.

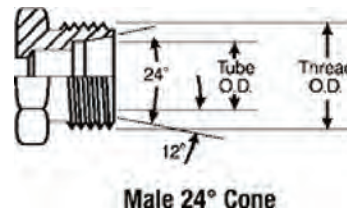
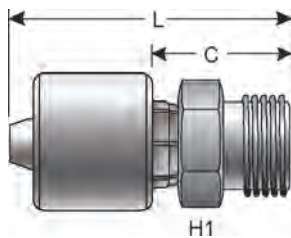

Part No.	Descr.	Prod. No.	⌀		H1	L		C		
			"	mm		"	mm	"	mm	
G21715-2038	20MGS-38MDH	7347-86115	1 1/4	31.8	M52X2.0	55	4.84	122.9	2.04	51.8

## 1 1/4" Special One-Piece Couplings - Female DIN 24° Cone Swivel - Heavy Series with O-Ring

MGS Couplings for use with MC4-20 Crimper Only.

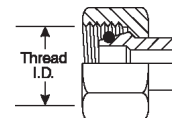
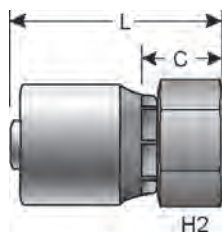

Part No.	Descr.	Prod. No.	⌀		H2	L		C		
			"	mm		"	mm	"	mm	
G21720-2038	20MGS-38FDHORX	7347-86095	1 1/4	31.8	M52X2.0	60	5.71	145.0	2.91	73.9

EQUIPMENT
HOSE/CPLG. SELECTION
G8K COUPLINGS
GLOBALSPIRAL COUPLINGS
STAINLESS STEEL SPIRAL
MEGACRIMP COUPLINGS
STAINLESS STEEL BRAID
POWER CRIMP COUPLINGS
FIELD ATTACHABLE G1 & G2 COUPLINGS
FIELD ATTACHABLE C5 COUPLINGS
C14 COUPLINGS
GL COUPLINGS
GLX COUPLINGS
PCTS THERMOPLASTIC COUPLINGS
POLARSEAL COUPLINGS (ACA)
POLARSEAL II COUPLINGS (ACC)
POLARSEAL II COUPLINGS (ACB)
POWER STEERING
ADAPTERS
QUICK DISCONNECT COUPLERS
BALL VALVES
LIVE SWIVEL
ASSEMBLY FABRICATION
ACCESSORIES
EQUIPMENT AND PARTS
KITS
AIR BRAKE HOSE ASSY
BRASS



# 1 1/4" Special One-Piece Couplings - Female British Standard Pipe Parallel O-Ring Swivel

MGS Couplings for use with MC4-20 Crimper Only.

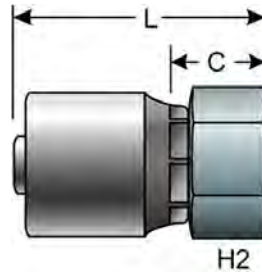

Part No.	Descr.	Prod. No.	⊖			H2	L		C	
			"	mm	"	mm	"	mm	"	mm
G21830-2020	20MGS-20FBSPORX	7347-86105	1 1/4	31.8	1 1/4-11	60	4.59	116.6	1.79	45.5

EQUIPMENT
HOSE/CPLG. SELECTION
G8K COUPLINGS
<b>GLOBALSPIRAL COUPLINGS</b>
STAINLESS STEEL SPIRAL
MEGACRIMP COUPLINGS
STAINLESS STEEL BRAID
POWER CRIMP COUPLINGS
FIELD ATTACHABLE G1 & G2 COUPLINGS
FIELD ATTACHABLE C5 COUPLINGS
C14 COUPLINGS
GL COUPLINGS
GLX COUPLINGS
PCTS THERMOPLASTIC COUPLINGS
POLARSEAL COUPLINGS (ACA)
POLARSEAL II COUPLINGS (ACC)
POLARSEAL II COUPLINGS (ACB)
POWER STEERING
ADAPTERS
QUICK DISCONNECT COUPLERS
BALL VALVES
LIVE SWIVEL
ASSEMBLY FABRICATION
ACCESSORIES
EQUIPMENT AND PARTS
KITS
AIR BRAKE HOSE ASSY
BRASS



### Male Pipe (NPTF - 30° Cone Seat)



Part No.	Descr.	Prod. No.	⊖		H1	L		C		
			"	mm		"	mm	"	mm	
G22100-2424	24GSP-24MP	7347-20725	1 1/2	38.1	1 1/2-11 1/2	2	5.24	133.1	2.34	59.4
G22100-3232	32GSP-32MP	7347-20795	2	50.8	2-11 1/2	2.50	6.05	153.7	2.43	61.7

### API Line Pipe Connection

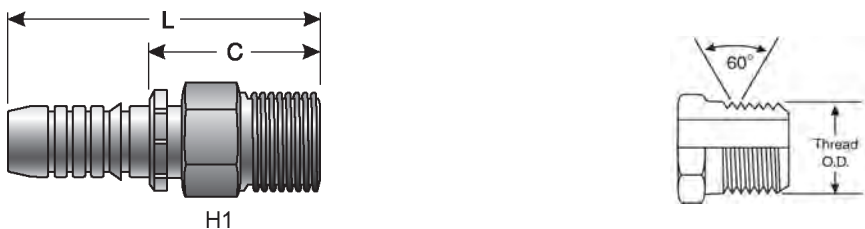

Part No.	Descr.	Prod. No.	⊖		H1	L		C		
			"	mm		"	mm	"	mm	
G22102-2424	24GSP-24API-LP	7347-85665	1 1/2	38.1	1 1/2-11 1/2	2	5.45	138.4	2.65	67.3
G22102-3232	32GSP-32MPAPI	7347-85415	2	50.8	2-11 1/2	2.50	7.90	200.7	4.28	108.7

### Male Pipe (NPTF - 30° Cone Seat) - Long Hex



Part No.	Descr.	Prod. No.	⊖		H1	L		C		
			"	mm		"	mm	"	mm	
G22103-2424	24GSP-24MPLH	7347-20745	1 1/2	38.1	1 1/2-11 1/2	2	6.29	159.8	3.40	86.4

- EQUIPMENT
- HOSE/CPLG. SELECTION
- G8K COUPLINGS
- GLOBALSPIRAL COUPLINGS
- STAINLESS STEEL SPIRAL
- MEGACRIMP COUPLINGS
- STAINLESS STEEL BRAID
- POWER CRIMP COUPLINGS
- FIELD ATTACHABLE G1 & G2 COUPLINGS
- FIELD ATTACHABLE C5 COUPLINGS
- C14 COUPLINGS
- GL COUPLINGS
- GLX COUPLINGS
- PCTS THERMOPLASTIC COUPLINGS
- POLARSEAL COUPLINGS (ACA)
- POLARSEAL II COUPLINGS (ACC)
- POLARSEAL II COUPLINGS (ACB)
- POWER STEERING
- ADAPTERS
- QUICK DISCONNECT COUPLERS
- BALL VALVES
- LIVE SWIVEL
- ASSEMBLY FABRICATION
- ACCESSORIES
- EQUIPMENT AND PARTS
- KITS
- AIR BRAKE HOSE ASSY
- BRASS



EQUIPMENT
HOSE/CPLG. SELECTION
G8K COUPLINGS
<b>GLOBALSPIRAL COUPLINGS</b>
STAINLESS STEEL SPIRAL
MEGACRIMP COUPLINGS
STAINLESS STEEL BRAID
POWER CRIMP COUPLINGS
FIELD ATTACHABLE G1 & G2 COUPLINGS
FIELD ATTACHABLE C5 COUPLINGS
C14 COUPLINGS
GL COUPLINGS
GLX COUPLINGS
PCTS THERMOPLASTIC COUPLINGS
POLARSEAL COUPLINGS (ACA)
POLARSEAL II COUPLINGS (ACC)
POLARSEAL II COUPLINGS (ACB)
POWER STEERING
ADAPTERS
QUICK DISCONNECT COUPLERS
BALL VALVES
LIVE SWIVEL
ASSEMBLY FABRICATION
ACCESSORIES
EQUIPMENT AND PARTS
KITS
AIR BRAKE HOSE ASSY
BRASS

### Male JIC 37° Flare

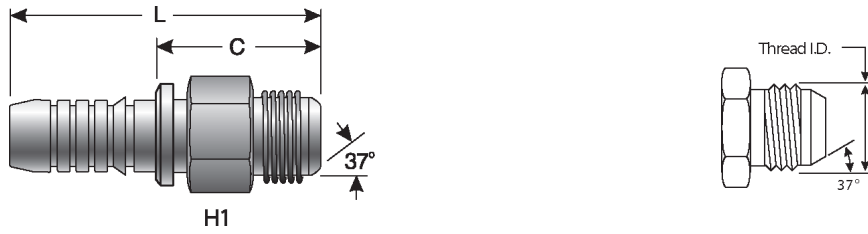

Part No.	Descr.	Prod. No.	⊖		H1	L		C		
			"	mm		"	mm	"	mm	
G22165-2420	24GSP-20MJ	7347-81455	1 1/2	38.1	1 5/8-12	1.97	5.00	127.0	2.10	53.3
G22165-2424	24GSP-24MJ	7347-81465	1 1/2	38.1	1 7/8-12	1.97	5.12	130.1	2.22	56.4
G22165-3232	32GSP-32MJ	7347-81535	2	50.8	2 1/2-12	2.56	6.34	161.0	2.72	69.1

### Female JIC 37° Flare Swivel



Part No.	Descr.	Prod. No.	⊖		H1	H2	L		C		
			"	mm			"	mm	"	mm	
G22170-2424	24GSP-24FJX	7347-82455	1 1/2	38.1	1 7/8-12	1.97	2.36	5.64	143.3	2.74	69.6
G22170-2432	24GSP-32FJX	7347-82465	1 1/2	38.1	2 1/2-12	2.56	2.98	6.88	174.8	3.17	80.5
G22170-3232	32GSP-32FJX	7347-82525	2	50.8	2 1/2-12	2.56	2.95	6.80	172.7	3.17	80.5

### Female JIC 37° Flare Swivel - 45° Bent Tube

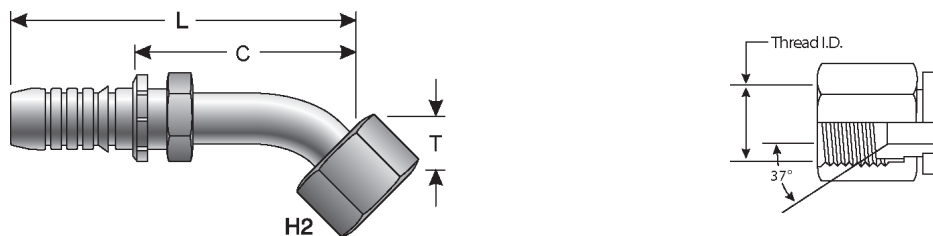

Part No.	Descr.	Prod. No.	⊖		H2	T		L		C		
			"	mm		"	mm	"	mm	"	mm	
G22175-2424	24GSP-24FJX45-050	7347-83735	1 1/2	38.1	1 7/8-12	2 1/3	1.97	50.0	9.17	232.9	6.28	159.5



### Female JIC 37° Flare Swivel - 90° Bent Tube

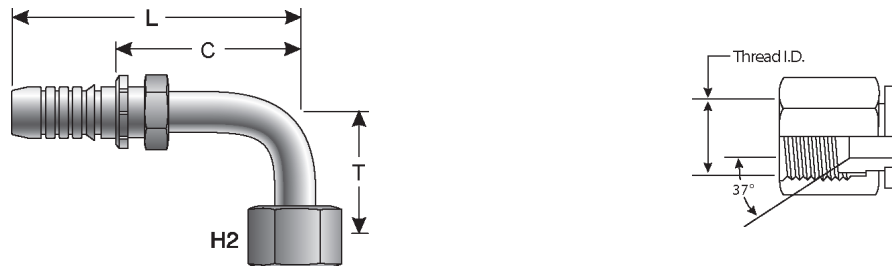

Part No.	Descr.	Prod. No.	⊖		H2	T		L		C		
			"	mm		"	mm	"	mm	"	mm	
G22179-2424	24GSP-24FJX90-089	7347-84745	1 1/2	38.1	1 7/8-12	2 1/3	3.50	88.9	8.35	212.1	5.45	138.4
G22180-2424	24GSP-24FJX90-118	7347-84755	1 1/2	38.1	1 7/8-12	2 1/3	4.65	118.1	7.46	189.5	4.56	115.8
G22180-3232	32GSP-32FJX90M	7347-84785	2	50.8	2 1/2-12	3	5.51	140.0	10.71	272.0	7.07	179.6

### Male Flat-Face O-Ring

Includes Peroxide-cured O-Ring.  
Metric Hex per ISO Draft International Standard 12151-1.  
Utilizes SAE J1453 Captive O-Ring Groove for Improved O-Ring Retention.



Part No.	Descr.	Prod. No.	⊖		H1	L		C		
			"	mm		mm	"	mm	"	mm
G22225-2424	24GSP-24MFFOR	7347-23905	1 1/2	38.1	2-12	55	5.12	130.1	2.22	56.4

### Female Flat-Face O-Ring Swivel

Metric Hex per ISO Draft International Standard 12151-1.  
SAE J1453 O-Ring Face Seal.

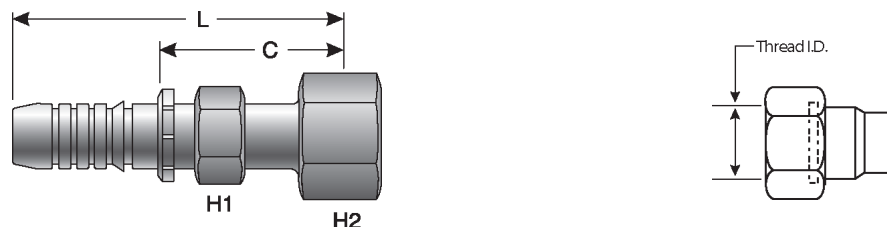

Part No.	Descr.	Prod. No.	⊖		H1	H2	L		C		
			"	mm			mm	mm	"	mm	"
G22230-2424	24GSP-24FFORX	7347-30725	1 1/2	38.1	2-12	55	2 1/4	5.17	131.3	2.37	60.2

EQUIPMENT
HOSE/CPLG. SELECTION
G8K COUPLINGS
GLOBALSPIRAL COUPLINGS
STAINLESS STEEL SPIRAL
MEGACRIMP COUPLINGS
STAINLESS STEEL BRAID
POWER CRIMP COUPLINGS
FIELD ATTACHABLE G1 & G2 COUPLINGS
FIELD ATTACHABLE C5 COUPLINGS
C14 COUPLINGS
GL COUPLINGS
GLX COUPLINGS
PCTS THERMOPLASTIC COUPLINGS
POLARSEAL COUPLINGS (ACA)
POLARSEAL II COUPLINGS (ACC)
POLARSEAL II COUPLINGS (ACB)
POWER STEERING
ADAPTERS
QUICK DISCONNECT COUPLERS
BALL VALVES
LIVE SWIVEL
ASSEMBLY FABRICATION
ACCESSORIES
EQUIPMENT AND PARTS
KITS
AIR BRAKE HOSE ASSY
BRASS



EQUIPMENT
HOSE/CPLG. SELECTION
G8K COUPLINGS
<b>GLOBALSPIRAL COUPLINGS</b>
STAINLESS STEEL SPIRAL
MEGACRIMP COUPLINGS
STAINLESS STEEL BRAID
POWER CRIMP COUPLINGS
FIELD ATTACHABLE G1 & G2 COUPLINGS
FIELD ATTACHABLE C5 COUPLINGS
C14 COUPLINGS
GL COUPLINGS
GLX COUPLINGS
PCTS THERMOPLASTIC COUPLINGS
POLARSEAL COUPLINGS (ACA)
POLARSEAL II COUPLINGS (ACC)
POLARSEAL II COUPLINGS (ACB)
POWER STEERING
ADAPTERS
QUICK DISCONNECT COUPLERS
BALL VALVES
LIVE SWIVEL
ASSEMBLY FABRICATION
ACCESSORIES
EQUIPMENT AND PARTS
KITS
AIR BRAKE HOSE ASSY
BRASS

## Female Flat-Face O-Ring Swivel - 45° Bent Tube

Metric Hex per ISO Draft International Standard 12151-1.  
SAE J1453 O-Ring Face Seal.

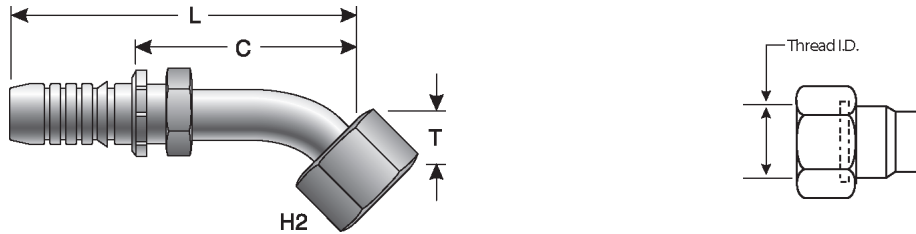

Part No.	Descr.	Prod. No.	⌀		H2	T		L		C		
			"	mm		"	mm	"	mm	"	mm	
G22235-2424	24GSP-24FFORX45-036	7347-31725	1 1/2	38.1	2-12	2 1/4	2.70	68.6	7.61	193.3	4.81	122.2

## Female Flat-Face O-Ring Swivel - 90° Bent Tube

Metric Hex per ISO Draft International Standard 12151-1.  
SAE J1453 O-Ring Face Seal.

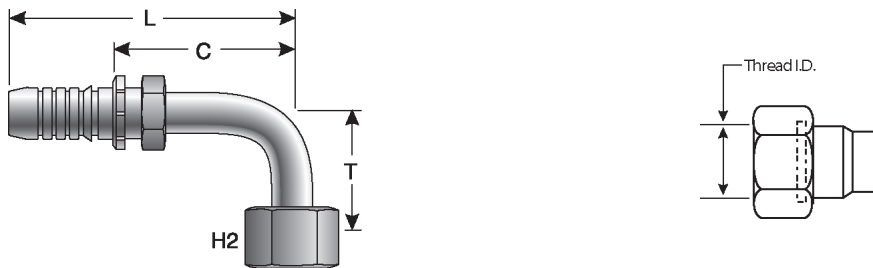

Part No.	Descr.	Prod. No.	⌀		H2	T		L		C		
			"	mm		"	mm	"	mm	"	mm	
G22240-2424	24GSP-24FFORX90M	7347-33725	1 1/2	38.1	2-12	2 1/4	3.41	86.6	7.61	193.3	4.81	122.2
G22241-2424	24GSP-24FFORX90L	7347-34725	1 1/2	38.1	2-12	2 1/4	5.54	140.7	7.61	193.3	4.81	122.2



### Code 61 O-Ring Flange

-24FL Max. W.P. 3,000 psi; -32FL Max. W.P. 3,000 psi.  
See Accessories for O-Rings.

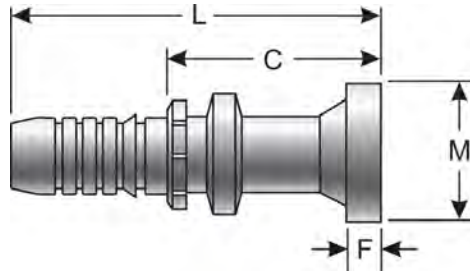

Part No.	Descr.	Prod. No.	⊖		M		L		C		F	
			"	mm	"	mm	"	mm	"	mm	"	mm
G22300-2420	24GSP-20FL	7347-41715	1 1/2	38.1	2.00	50.8	5.74	145.8	2.85	72.4	.32	8.1
G22300-2424	24GSP-24FL	7347-41725	1 1/2	38.1	2.38	60.5	6.02	152.9	3.12	79.3	.32	8.1
G22300-2432	24GSP-32FL	7347-41735	1 1/2	38.1	2.81	71.4	5.79	147.1	2.99	76.0	.38	9.7
G22300-3224	32GSP-24FL	7347-41785	2	50.8	2.38	60.5	6.53	165.9	2.49	63.3	.32	8.1
G22300-3232	32GSP-32FL	7347-41795	2	50.8	2.81	71.4	6.27	159.3	2.65	67.3	.38	9.7
G22300-3240	32GSP-40FL	7347-41805	2	50.8	3.31	84.1	8.52	216.4	2.99	76.0	.38	9.7

### Code 61 O-Ring Flange - 22 1/2° Bent Tube

-24FL Max. W.P. 3,000 psi; -32FL Max. W.P. 3,000 psi.  
S, M and L Drops per ISO Final Draft International Standard 12151-3.  
See Accessories for O-Rings.

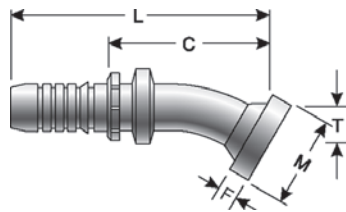

Part No.	Descr.	Prod. No.	⊖		M		T		L		C		F	
			"	mm	"	mm	"	mm	"	mm	"	mm	"	mm
G22302-2424	24GSP-24FL22M	7347-42725	1 1/2	38.1	2.38	60.5	.71	18.0	8.31	211.0	5.41	137.4	.32	8.1
G22302-2432	24GSP-32FL22M	7347-42735	1 1/2	38.1	2.81	71.4	.87	22.1	8.43	214.1	5.52	140.2	.38	9.7
G22302-3232	32GSP-32FL22M	7347-42795	2	50.8	2.81	71.4	.97	24.6	10.83	275.1	7.22	183.4	.38	9.7

- EQUIPMENT
- HOSE/CPLG. SELECTION
- G8K COUPLINGS
- GLOBALSPIRAL COUPLINGS
- STAINLESS STEEL SPIRAL
- MEGACRIMP COUPLINGS
- STAINLESS STEEL BRAID
- POWER CRIMP COUPLINGS
- FIELD ATTACHABLE G1 & G2 COUPLINGS
- FIELD ATTACHABLE C5 COUPLINGS
- C14 COUPLINGS
- GL COUPLINGS
- GLX COUPLINGS
- PCTS THERMOPLASTIC COUPLINGS
- POLARSEAL COUPLINGS (ACA)
- POLARSEAL II COUPLINGS (ACC)
- POLARSEAL II COUPLINGS (ACB)
- POWER STEERING
- ADAPTERS
- QUICK DISCONNECT COUPLERS
- BALL VALVES
- LIVE SWIVEL
- ASSEMBLY FABRICATION
- ACCESSORIES
- EQUIPMENT AND PARTS
- KITS
- AIR BRAKE HOSE ASSY
- BRASS



EQUIPMENT
HOSE/CPLG. SELECTION
G8K COUPLINGS
GLOBALSPIRAL COUPLINGS
STAINLESS STEEL SPIRAL
MEGACRIMP COUPLINGS
STAINLESS STEEL BRAID
POWER CRIMP COUPLINGS
FIELD ATTACHABLE G1 & G2 COUPLINGS
FIELD ATTACHABLE C5 COUPLINGS
C14 COUPLINGS
GL COUPLINGS
GLX COUPLINGS
PCTS THERMOPLASTIC COUPLINGS
POLARSEAL COUPLINGS (ACA)
POLARSEAL II COUPLINGS (ACC)
POLARSEAL II COUPLINGS (ACB)
POWER STEERING
ADAPTERS
QUICK DISCONNECT COUPLERS
BALL VALVES
LIVE SWIVEL
ASSEMBLY FABRICATION
ACCESSORIES
EQUIPMENT AND PARTS
KITS
AIR BRAKE HOSE ASSY
BRASS

### Code 61 O-Ring Flange - 30° Bent Tube

-24FL Max. W.P. 3,000 psi; -32FL Max. W.P. 3,000 psi.  
S, M and L Drops per ISO Final Draft International Standard 12151-3.  
See Accessories for O-Rings.

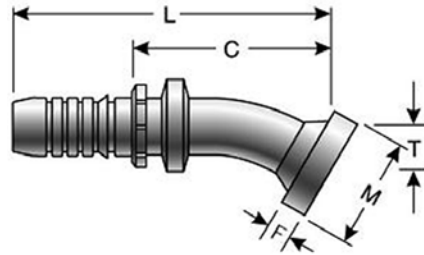

Part No.	Descr.	Prod. No.	⊖		M		T		L		C		F	
			"	mm	"	mm	"	mm	"	mm	"	mm	"	mm
G22304-2424	24GSP-24FL30S	7347-43725	1 1/2	38.1	2.38	60.5	.98	24.9	8.23	209.0	5.31	134.9	.32	8.1
G22304-2432	24GSP-32FL30M	7347-43735	1 1/2	38.1	2.81	71.4	1.26	32.0	8.27	210.1	5.39	136.9	.38	9.7
G22304-3232	32GSP-32FL30M	7347-43795	2	50.8	2.81	71.4	1.25	31.8	10.70	271.8	7.10	180.3	.38	9.7

### Code 61 O-Ring Flange - 45° Bent Tube

-24FL Max. W.P. 3,000 psi; -32FL Max. W.P. 3,000 psi.  
S, M and L Drops per ISO Final Draft International Standard 12151-3.  
See Accessories for O-Rings.

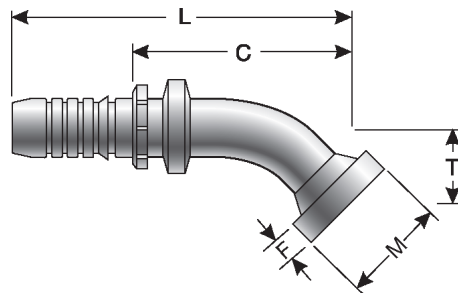

Part No.	Descr.	Prod. No.	⊖		M		T		L		C		F	
			"	mm	"	mm	"	mm	"	mm	"	mm	"	mm
G22306-2420	24GSP-20FL45S	7347-44715	1 1/2	38.1	2.00	50.8	1.26	32.0	7.09	180.1	4.49	114.1	.32	8.1
G22306-2424	24GSP-24FL45S	7347-44725	1 1/2	38.1	2.38	60.5	1.50	38.1	7.95	201.9	5.05	128.3	.32	8.1
G22306-2432	24GSP-32FL45S	7347-44735	1 1/2	38.1	2.81	71.4	2.05	52.1	7.87	199.9	4.97	126.2	.38	9.7
G22306-3224	32GSP-24FL45S	7347-44785	2	50.8	2.38	60.5	1.50	38.1	8.10	205.8	4.48	113.8	.32	8.1
G22307-3232	32GSP-32FL45-066	7347-44805	2	50.8	2.81	71.4	2.60	66.0	10.12	257.1	6.50	165.1	.38	9.7



### Code 61 O-Ring Flange - 60° Bent Tube

-24FL Max. W.P. 3,000 psi; -32FL Max. W.P. 3,000 psi.  
S, M and L Drops per ISO Final Draft International Standard 12151-3.  
See Accessories for O-Rings.

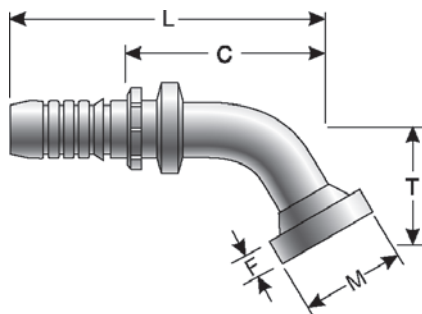

Part No.	Descr.	Prod. No.	⊖		M		T		L		C		F	
			"	mm	"	mm	"	mm	"	mm	"	mm	"	mm
G22308-2424	24GSP-24FL60S	7347-45725	1 1/2	38.1	2.38	60.5	2.08	52.8	9.09	230.9	6.20	157.5	.32	8.1
G22309-2432	24GSP-32FL60S	7347-45735	1 1/2	38.1	2.81	71.4	2.95	74.9	9.21	233.9	6.30	160.0	.38	9.7
G22309-3232	32GSP-32FL60S	7347-45805	2	50.8	2.81	71.4	2.95	74.9	10.20	259.1	6.56	166.6	.38	9.7

### Code 61 O-Ring Flange - 67 1/2° Bent Tube

-24FL Max. W.P. 3,000 psi; -32FL Max. W.P. 3,000 psi.  
S, M and L Drops per ISO Final Draft International Standard 12151-3.  
See Accessories for O-Rings.

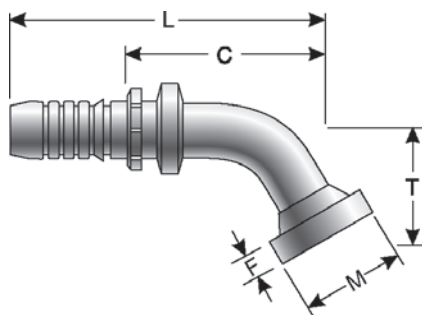

Part No.	Descr.	Prod. No.	⊖		M		T		L		C		F	
			"	mm	"	mm	"	mm	"	mm	"	mm	"	mm
G22311-2424	24GSP-24FL67S	7347-46725	1 1/2	38.1	2.38	60.5	2.40	61.0	8.90	226.1	5.90	149.9	.32	8.1
G22311-2432	24GSP-32FL67S	7347-46735	1 1/2	38.1	2.81	71.4	3.33	84.6	10.20	259.1	5.90	149.9	.38	9.7
G22311-3232	32GSP-32FL67S	7347-46795	2	50.8	2.81	71.4	3.84	97.5	10.20	259.1	6.56	166.6	.38	9.7

- EQUIPMENT
- HOSE/CPLG. SELECTION
- G8K COUPLINGS
- GLOBALSPIRAL COUPLINGS
- STAINLESS STEEL SPIRAL
- MEGACRIMP COUPLINGS
- STAINLESS STEEL BRAID
- POWER CRIMP COUPLINGS
- FIELD ATTACHABLE G1 & G2 COUPLINGS
- FIELD ATTACHABLE C5 COUPLINGS
- C14 COUPLINGS
- GL COUPLINGS
- GLX COUPLINGS
- PCTS THERMOPLASTIC COUPLINGS
- POLARSEAL COUPLINGS (ACA)
- POLARSEAL II COUPLINGS (ACC)
- POLARSEAL II COUPLINGS (ACB)
- POWER STEERING
- ADAPTERS
- QUICK DISCONNECT COUPLERS
- BALL VALVES
- LIVE SWIVEL
- ASSEMBLY FABRICATION
- ACCESSORIES
- EQUIPMENT AND PARTS
- KITS
- AIR BRAKE HOSE ASSY
- BRASS





EQUIPMENT
HOSE/CPLG. SELECTION
G8K COUPLINGS
GLOBALSPIRAL COUPLINGS
STAINLESS STEEL SPIRAL
MEGACRIMP COUPLINGS
STAINLESS STEEL BRAID
POWER CRIMP COUPLINGS
FIELD ATTACHABLE G1 & G2 COUPLINGS
FIELD ATTACHABLE C5 COUPLINGS
C14 COUPLINGS
GL COUPLINGS
GLX COUPLINGS
PCTS THERMOPLASTIC COUPLINGS
POLARSEAL COUPLINGS (ACA)
POLARSEAL II COUPLINGS (ACC)
POLARSEAL II COUPLINGS (ACB)
POWER STEERING
ADAPTERS
QUICK DISCONNECT COUPLERS
BALL VALVES
LIVE SWIVEL
ASSEMBLY FABRICATION
ACCESSORIES
EQUIPMENT AND PARTS
KITS
AIR BRAKE HOSE ASSY
BRASS

### Code 61 O-Ring Flange - 90° Bent Tube

-24FL Max. W.P. 3,000 psi; -32FL Max. W.P. 3,000 psi.  
S, M and L Drops per ISO Final Draft International Standard 12151-3.  
See Accessories for O-Rings.

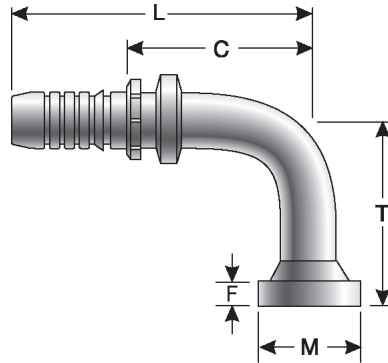

Part No.	Descr.	Prod. No.	⊖		M		T		L		C		F	
			"	mm	"	mm	"	mm	"	mm	"	mm	"	mm
G22314-2420	24GSP-20FL90S	7347-47715	1 1/2	38.1	2.00	50.8	2.68	68.1	6.81	173.0	3.92	99.6	.32	8.1
G22314-2424	24GSP-24FL90S	7347-47725	1 1/2	38.1	2.38	60.5	3.19	81.0	7.24	183.9	4.33	110.0	.32	8.1
G22315-2424	24GSP-24FL90M	7347-74725	1 1/2	38.1	2.38	60.5	4.09	103.9	6.89	175.0	4.01	101.9	.32	8.1
G22316-2424	24GSP-24FL90-148	7347-85625	1 1/2	38.1	2.38	60.5	5.83	148.1	6.89	175.0	4.01	101.9	.32	8.1
G22314-2432	24GSP-32FL90S	7347-47735	1 1/2	38.1	2.81	71.4	4.72	119.9	6.90	175.3	4.01	101.9	.38	9.7
G22315-2432	24GSP-32FL90-080	7347-47745	1 1/2	38.1	2.81	71.4	3.15	80.0	6.99	177.6	4.01	101.9	.38	9.7
G22316-2432	24GSP-32FL90-170	7347-85435	1 1/2	38.1	2.81	71.4	6.69	169.9	6.88	174.8	3.99	101.4	.38	9.7
G22314-3224	32GSP-24FL90S	7347-47785	2	50.8	2.38	60.5	3.19	81.0	7.76	197.1	4.13	104.9	.32	8.1
G22314-3232	32GSP-32FL90-114	7347-47805	2	50.8	2.81	71.4	4.49	114.1	8.74	222.0	5.12	130.1	.38	9.7
G22315-3232	32GSP-32FL90-165	7347-85425	2	50.8	2.81	71.4	6.50	165.1	9.69	246.1	6.06	153.9	.38	9.7
G22316-3232	32GSP-32FL90-200	7347-85455	2	50.8	2.81	71.4	7.97	202.4	8.74	222.0	5.13	130.3	.38	9.7
G22315-3240	32GSP-40FL90-110	7347-74805	2	50.8	3.31	84.1	4.38	111.3	8.52	216.4	4.98	126.5	.38	9.7

### Code 61 O-Ring Flange - 110° Bent Tube

-24FL Max. W.P. 3,000 psi; -32FL Max. W.P. 3,000 psi.  
See Accessories for O-Rings.

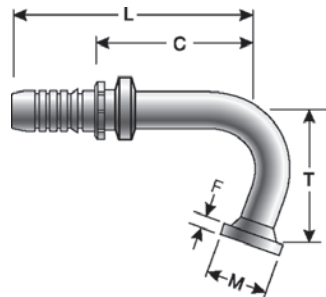

Part No.	Descr.	Prod. No.	⊖		M		T		L		C		F	
			"	mm	"	mm	"	mm	"	mm	"	mm	"	mm
G22325-2424	24GSP-24FL110-094	7347-85635	1 1/2	38.1	2.38	60.5	3.70	94.0	7.95	201.9	5.07	128.8	.32	8.1
G22325-3232	32GSP-32FL110-140	7347-85465	2	50.8	2.81	71.4	5.51	140.0	9.80	248.9	6.40	162.6	.38	9.7



### Code 61 O-Ring Flange - 120° Bent Tube

-24FL Max. W.P. 3,000 psi; -32FL Max. W.P. 3,000 psi.  
See Accessories for O-Rings.

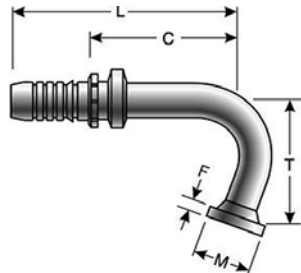

Part No.	Descr.	Prod. No.	⊖		M		T		L		C		F	
			"	mm	"	mm	"	mm	"	mm	"	mm	"	mm
G22327-2424	24GSP-24FL120-119	7347-85645	1 1/2	38.1	2.38	60.5	4.69	119.1	7.20	182.9	4.31	109.5	.32	8.1

### Code 61 O-Ring Flange - 125° Bent Tube

-24FL Max. W.P. 3,000 psi; -32FL Max. W.P. 3,000 psi.  
See Accessories for O-Rings.

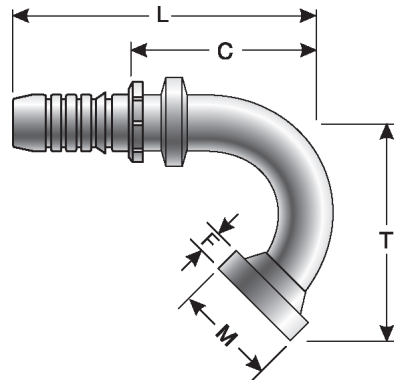

Part No.	Descr.	Prod. No.	⊖		M		T		L		C		F	
			"	mm	"	mm	"	mm	"	mm	"	mm	"	mm
G22329-3232	32GSP-32FL125-150	7347-85475	2	50.8	2.81	71.4	3.90	99.1	8.30	210.8	4.70	119.4	.38	9.7

EQUIPMENT
HOSE/CPLG. SELECTION
G8K COUPLINGS
GLOBALSPIRAL COUPLINGS
STAINLESS STEEL SPIRAL
MEGACRIMP COUPLINGS
STAINLESS STEEL BRAID
POWER CRIMP COUPLINGS
FIELD ATTACHABLE G1 & G2 COUPLINGS
FIELD ATTACHABLE C5 COUPLINGS
C14 COUPLINGS
GL COUPLINGS
GLX COUPLINGS
PCTS THERMOPLASTIC COUPLINGS
POLARSEAL COUPLINGS (ACA)
POLARSEAL II COUPLINGS (ACC)
POLARSEAL II COUPLINGS (ACB)
POWER STEERING
ADAPTERS
QUICK DISCONNECT COUPLERS
BALL VALVES
LIVE SWIVEL
ASSEMBLY FABRICATION
ACCESSORIES
EQUIPMENT AND PARTS
KITS
AIR BRAKE HOSE ASSY
BRASS



EQUIPMENT
HOSE/CPLG. SELECTION
G8K COUPLINGS
<b>GLOBALSPIRAL COUPLINGS</b>
STAINLESS STEEL SPIRAL
MEGACRIMP COUPLINGS
STAINLESS STEEL BRAID
POWER CRIMP COUPLINGS
FIELD ATTACHABLE G1 & G2 COUPLINGS
FIELD ATTACHABLE C5 COUPLINGS
C14 COUPLINGS
GL COUPLINGS
GLX COUPLINGS
PCTS THERMOPLASTIC COUPLINGS
POLARSEAL COUPLINGS (ACA)
POLARSEAL II COUPLINGS (ACC)
POLARSEAL II COUPLINGS (ACB)
POWER STEERING
ADAPTERS
QUICK DISCONNECT COUPLERS
BALL VALVES
LIVE SWIVEL
ASSEMBLY FABRICATION
ACCESSORIES
EQUIPMENT AND PARTS
KITS
AIR BRAKE HOSE ASSY
BRASS

### Code 62 O-Ring Flange Heavy

See Accessories for O-Rings.

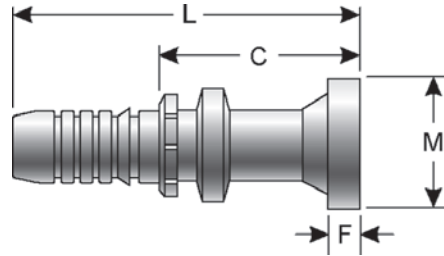

Part No.	Descr.	Prod. No.	⌀		M		L		C		F	
			"	mm	"	mm	"	mm	"	mm	"	mm
G22350-2424	24GSP-24FLH	7347-48725	1 1/2	38.1	2.50	63.5	6.57	166.9	3.68	93.5	.50	12.7
G22350-2432	24GSP-32FLH	7347-48735	1 1/2	38.1	3.13	79.5	6.57	166.9	3.68	93.5	.50	12.7
G22350-3232	32GSP-32FLH	7347-48795	2	50.8	3.13	79.5	7.09	180.1	3.46	87.9	.50	12.7

### Code 62 O-Ring Flange Heavy - 45° Bent Tube

S, M and L Drops per ISO Final Draft International Standard 12151-3.  
See Accessories for O-Rings.

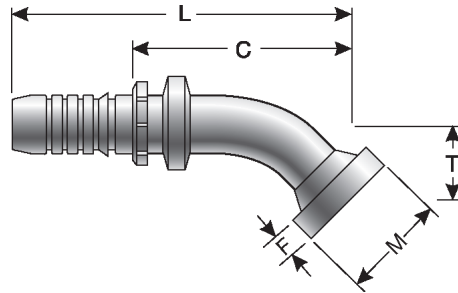

Part No.	Descr.	Prod. No.	⌀		M		T		L		C		F	
			"	mm	"	mm	"	mm	"	mm	"	mm	"	mm
G22357-2424	24GSP-24FLH45M	7347-51725	1 1/2	38.1	2.50	63.5	1.73	43.9	7.56	192.0	4.65	118.1	.50	12.7
G22357-2432	24GSP-32FLH45S	7347-51735	1 1/2	38.1	3.13	79.5	2.05	52.1	7.87	199.9	4.98	126.5	.50	12.7
G22357-3232	32GSP-32FLH45-066	7347-51805	2	50.8	3.13	79.5	2.60	66.0	10.67	271.0	7.06	179.3	.50	12.7



### Code 62 O-Ring Flange Heavy - 90° Bent Tube

S, M and L Drops per ISO Final Draft International Standard 12151-3.  
See Accessories for O-Rings.

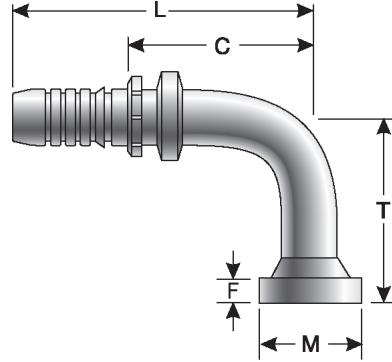

Part No.	Descr.	Prod. No.	⊖		M		T		L		C		F	
			"	mm	"	mm	"	mm	"	mm	"	mm	"	mm
G22365-2424	24GSP-24FLH90-094	7347-79105	1 1/2	38.1	2.50	63.5	3.70	94.0	6.91	175.5	4.01	101.9	.50	12.7
G22364-2432	24GSP-32FLH90S	7347-54735	1 1/2	38.1	3.13	79.5	4.72	119.9	6.96	176.8	4.06	103.1	.50	12.7
G22365-3232	32GSP-32FLH90M	7347-75795	2	50.8	3.13	79.5	5.40	137.2	8.72	221.5	5.09	129.3	.50	12.7

### Code 61 Flange without O-Ring Groove

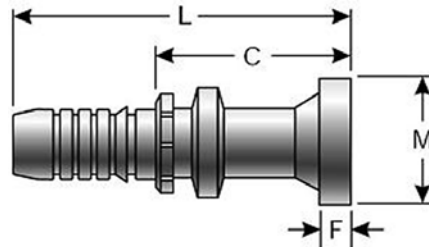

Part No.	Descr.	Prod. No.	⊖		M		L		C		F	
			"	mm	"	mm	"	mm	"	mm	"	mm
G22370-2424	24GSP-24FLFF	7347-85655	1 1/2	38.1	2.38	60.5	6.02	152.9	3.12	79.3	.32	8.1

### Hose Length Extender

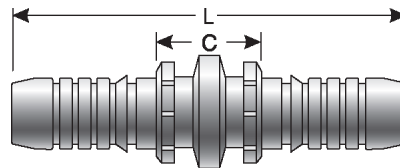

Part No.	Descr.	Prod. No.	⊖		L		C	
			"	mm	"	mm	"	mm
G22535-2424	24GSP-24HLE	7347-85445	1 1/2	38.1	7.33	186.2	1.53	38.9

EQUIPMENT
HOSE/CPLG. SELECTION
G8K COUPLINGS
GLOBALSPIRAL COUPLINGS
STAINLESS STEEL SPIRAL
MEGACRIMP COUPLINGS
STAINLESS STEEL BRAID
POWER CRIMP COUPLINGS
FIELD ATTACHABLE G1 & G2 COUPLINGS
FIELD ATTACHABLE C5 COUPLINGS
C14 COUPLINGS
GL COUPLINGS
GLX COUPLINGS
PCTS THERMOPLASTIC COUPLINGS
POLARSEAL COUPLINGS (ACA)
POLARSEAL II COUPLINGS (ACC)
POLARSEAL II COUPLINGS (ACB)
POWER STEERING
ADAPTERS
QUICK DISCONNECT COUPLERS
BALL VALVES
LIVE SWIVEL
ASSEMBLY FABRICATION
ACCESSORIES
EQUIPMENT AND PARTS
KITS
AIR BRAKE HOSE ASSY
BRASS

EQUIPMENT
HOSE/CPLG. SELECTION
G8K COUPLINGS
<b>GLOBALSPIRAL COUPLINGS</b>
STAINLESS STEEL SPIRAL
MEGACRIMP COUPLINGS
STAINLESS STEEL BRAID
POWER CRIMP COUPLINGS
FIELD ATTACHABLE G1 & G2 COUPLINGS
FIELD ATTACHABLE C5 COUPLINGS
C14 COUPLINGS
GL COUPLINGS
GLX COUPLINGS
PCTS THERMOPLASTIC COUPLINGS
POLARSEAL COUPLINGS (ACA)
POLARSEAL II COUPLINGS (ACC)
POLARSEAL II COUPLINGS (ACB)
POWER STEERING
ADAPTERS
QUICK DISCONNECT COUPLERS
BALL VALVES
LIVE SWIVEL
ASSEMBLY FABRICATION
ACCESSORIES
EQUIPMENT AND PARTS
KITS
AIR BRAKE HOSE ASSY
BRASS

### Hose Length Extender - Continued

Part No.	Descr.	Prod. No.	⊖		L		C	
			"	mm	"	mm	"	mm
G22535-3232	32GSP-32HLE	7347-79335	2	50.8	8.76	222.5	1.52	38.6

### Hose Length Extender - 90° Bent Tube

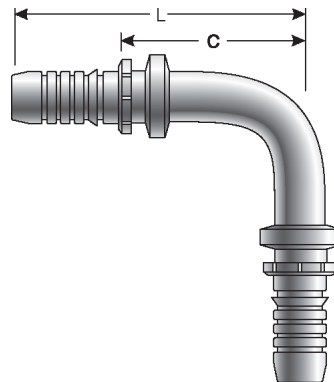

Part No.	Descr.	Prod. No.	⊖		L		C	
			"	mm	"	mm	"	mm
G22537-2424	24GSP-24HLE90-182	7347-85525	1 1/2	38.1	7.17	182.0	4.27	108.4

### Male DIN 24° Cone - Light Series

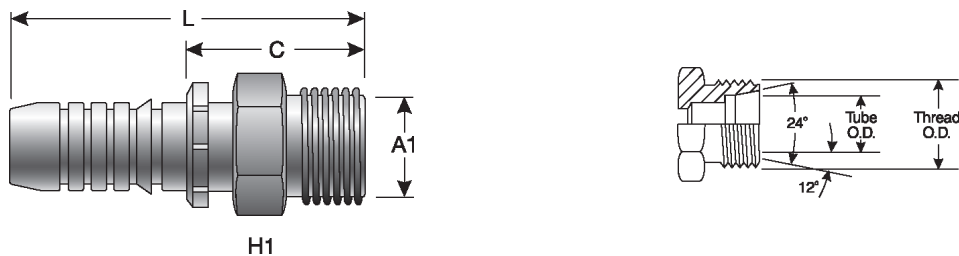

Part No.	Descr.	Prod. No.	⊖		M52X2.0	H1	L		C		A1
			"	mm			"	mm	"	mm	
G22615-2442	24GSP-42MDL	7347-95015	1 1/2	38.1	M52X2.0	55	4.72	119.9	1.83	46.5	42.0



### Female DIN 24° Cone Swivel - Light Series with O-Ring



Part No.	Descr.	Prod. No.	⊖		H2	L		C		A1	
			"	mm		"	mm	"	mm		
G22645-2442	24GSP-42FDLORX	7347-94955	1 1/2	38.1	M52X2.0	60	5.34	133.5	2.44	62.0	42.0
G22645-3242	32GSP-42FDLORX	7347-95005	2	50.8	M52X2.0	60	5.71	145.0	2.09	53.1	42.0

### Female DIN 24° Cone Swivel - Light Series with O-Ring - 45° Bent Tube

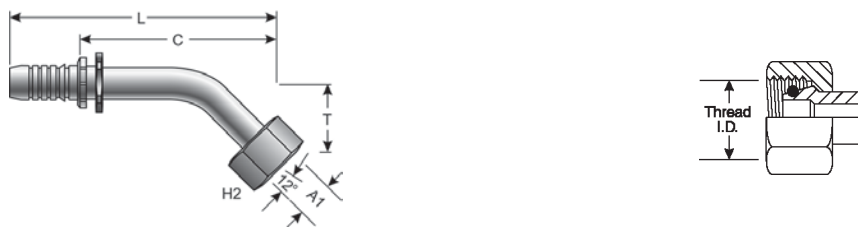

Part No.	Descr.	Prod. No.	⊖		H2	T		L		C		A1	
			"	mm		"	mm	"	mm	"	mm		
G22650-2442	24GSP-42FDLORX45	7347-95095	1 1/2	38.1	M52X2.0	60	1.73	43.9	8.22	208.8	5.32	135.1	42.0

### Female DIN 24° Cone Swivel - Light Series with O-Ring - 90° Bent Tube

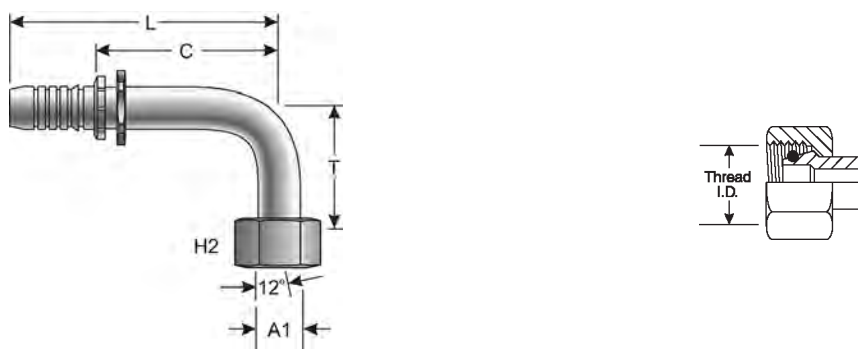

Part No.	Descr.	Prod. No.	⊖		H2	T		L		C		A1	
			"	mm		"	mm	"	mm	"	mm		
G22655-2442	24GSP-42FDLORX90	7347-94965	1 1/2	38.1	M52X2.0	60	3.62	92.0	7.66	194.6	4.76	120.9	42.0

EQUIPMENT
HOSE/CPLG. SELECTION
G8K COUPLINGS
GLOBALSPIRAL COUPLINGS
STAINLESS STEEL SPIRAL
MEGACRIMP COUPLINGS
STAINLESS STEEL BRAID
POWER CRIMP COUPLINGS
FIELD ATTACHABLE G1 & G2 COUPLINGS
FIELD ATTACHABLE C5 COUPLINGS
C14 COUPLINGS
GL COUPLINGS
GLX COUPLINGS
PCTS THERMOPLASTIC COUPLINGS
POLARSEAL COUPLINGS (ACA)
POLARSEAL II COUPLINGS (ACC)
POLARSEAL II COUPLINGS (ACB)
POWER STEERING
ADAPTERS
QUICK DISCONNECT COUPLERS
BALL VALVES
LIVE SWIVEL
ASSEMBLY FABRICATION
ACCESSORIES
EQUIPMENT AND PARTS
KITS
AIR BRAKE HOSE ASSY
BRASS

EQUIPMENT
HOSE/CPLG. SELECTION
G8K COUPLINGS
<b>GLOBALSPIRAL COUPLINGS</b>
STAINLESS STEEL SPIRAL
MEGACRIMP COUPLINGS
STAINLESS STEEL BRAID
POWER CRIMP COUPLINGS
FIELD ATTACHABLE G1 & G2 COUPLINGS
FIELD ATTACHABLE C5 COUPLINGS
C14 COUPLINGS
GL COUPLINGS
GLX COUPLINGS
PCTS THERMOPLASTIC COUPLINGS
POLARSEAL COUPLINGS (ACA)
POLARSEAL II COUPLINGS (ACC)
POLARSEAL II COUPLINGS (ACB)
POWER STEERING
ADAPTERS
QUICK DISCONNECT COUPLERS
BALL VALVES
LIVE SWIVEL
ASSEMBLY FABRICATION
ACCESSORIES
EQUIPMENT AND PARTS
KITS
AIR BRAKE HOSE ASSY
BRASS

## Female DIN 24° Cone Swivel - Heavy Series with O-Ring

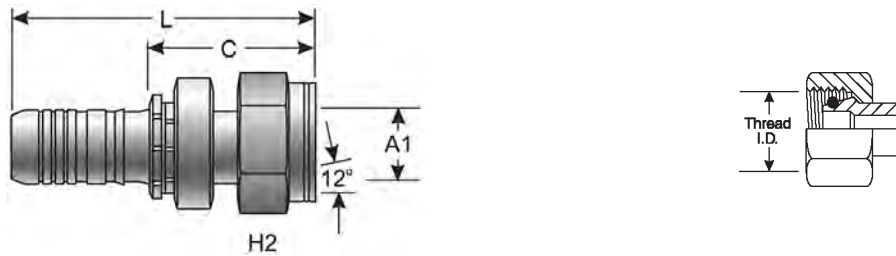

Part No.	Descr.	Prod. No.	⌀		H2	L		C		A1	
			"	mm		"	mm	"	mm		
G22720-2438	24GSP-38FDHORX	7347-95065	1 1/2	38.1	M52X2.0	60	5.91	150.1	3.00	76.2	38.0

## Female DIN 24° Cone Swivel - Heavy Series with O-Ring - 90° Bent Tube

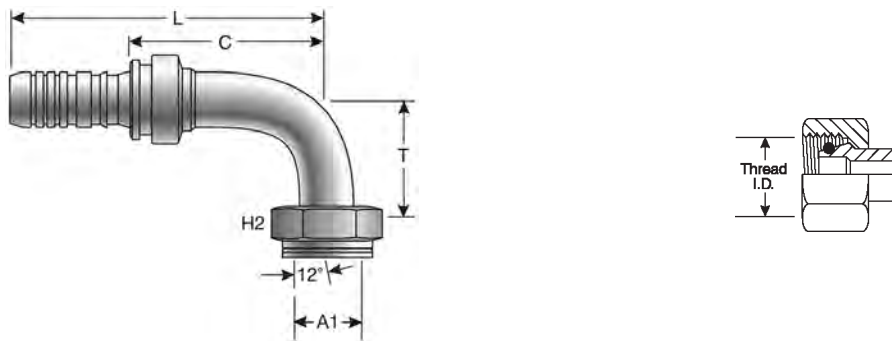

Part No.	Descr.	Prod. No.	⌀		H2	T		L		C		A1	
			"	mm		"	mm	"	mm	"	mm		
G22730-2438	24GSP-38FDHORX90	7347-95085	1 1/2	38.1	M52X2.0	60	3.62	91.9	7.66	194.6	4.76	120.9	38.0

## Male British Standard Pipe Tapered

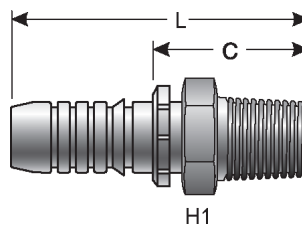

Part No.	Descr.	Prod. No.	⌀		H1	L		C		
			"	mm		"	mm	"	mm	
G22795-2424	24GSP-24MBSPT	7347-95235	1 1/2	38.1	1 1/2-11	55	5.12	130.1	2.22	56.4





## Female British Standard Parallel Pipe O-Ring Swivel

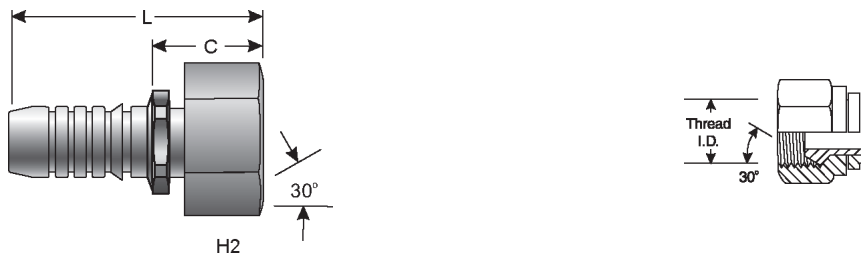

Part No.	Descr.	Prod. No.	⊖		H2	L		C		
			"	mm		"	mm	"	mm	
G22830-2424	24GSP-24FBSPORX	7347-95025	1 1/2	38.1	1 1/2-11	55	4.92	125.0	2.01	51.1
G22830-3232	32GSP-32FBSPORX	7347-95105	2	50.8	2-11	70	5.98	151.9	2.36	59.9

## Female British Standard Parallel Pipe O-Ring Swivel - 45° Bent Tube

S, M and L Drops and Hex per ISO Working Draft 12151-6.

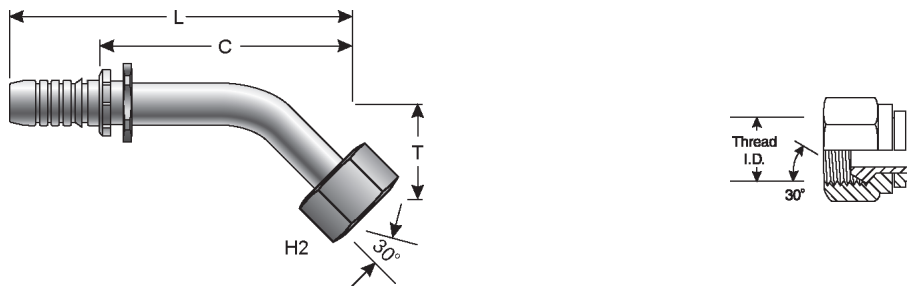

Part No.	Descr.	Prod. No.	⊖		H2	T		L		C		
			"	mm		"	mm	"	mm	"	mm	
G22831-2424	24GSP-24FBSPORX45	7347-95035	1 1/2	38.1	1 1/2-11	55	1.96	49.8	8.44	214.4	5.54	140.7
G22831-3232	32GSP-32FBSPORX45	7347-95115	2	50.8	2-11	70	2.45	62.2	10.87	276.1	7.24	183.9

- EQUIPMENT
- HOSE/CPLG. SELECTION
- G8K COUPLINGS
- GLOBALSPIRAL COUPLINGS
- STAINLESS STEEL SPIRAL
- MEGACRIMP COUPLINGS
- STAINLESS STEEL BRAID
- POWER CRIMP COUPLINGS
- FIELD ATTACHABLE G1 & G2 COUPLINGS
- FIELD ATTACHABLE C5 COUPLINGS
- C14 COUPLINGS
- GL COUPLINGS
- GLX COUPLINGS
- PCTS THERMOPLASTIC COUPLINGS
- POLARSEAL COUPLINGS (ACA)
- POLARSEAL II COUPLINGS (ACC)
- POLARSEAL II COUPLINGS (ACB)
- POWER STEERING
- ADAPTERS
- QUICK DISCONNECT COUPLERS
- BALL VALVES
- LIVE SWIVEL
- ASSEMBLY FABRICATION
- ACCESSORIES
- EQUIPMENT AND PARTS
- KITS
- AIR BRAKE HOSE ASSY
- BRASS



## Female British Standard Parallel Pipe O-Ring Swivel - 90° Bent Tube

S, M and L Drops and Hex per ISO Working Draft 12151-6.

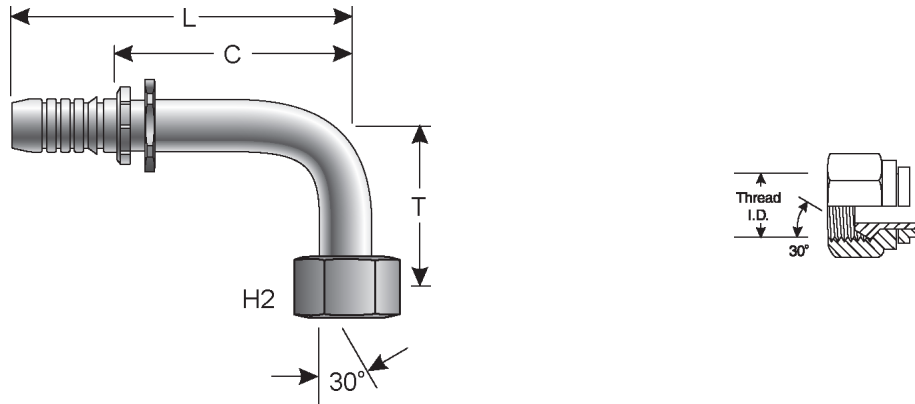

Part No.	Descr.	Prod. No.	⌀		H2	T		L		C		
			"	mm		"	mm	"	mm	"	mm	
G22832-2424	24GSP-24FBSPORX90	7347-95045	1 1/2	38.1	1 1/2-11	55	3.93	99.8	7.66	194.6	4.75	120.7
G22832-3232	32GSP-32FBSPORX90	7347-95125	2	50.8	2-11	70	5.08	129.0	10.02	254.5	6.40	162.6

## Female Komatsu Style Japanese Metric Swivel

These female swivels have been marked with two small notches on the hex to identify them as the Komatsu style.

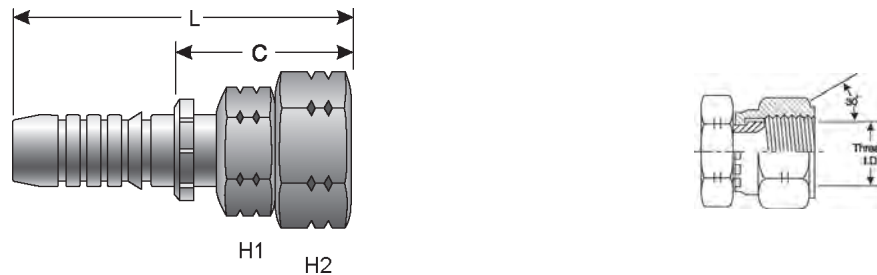

Part No.	Descr.	Prod. No.	⌀		H1	H2	L		C		
			"	mm			"	mm	"	mm	
G22910-2424	24GSP-24FKX	7347-35725	1 1/2	38.1	M42X1.5	49	59	5.81	147.6	2.92	74.2

EQUIPMENT
HOSE/CPLG. SELECTION
G8K COUPLINGS
GLOBALSPIRAL COUPLINGS
STAINLESS STEEL SPIRAL
MEGACRIMP COUPLINGS
STAINLESS STEEL BRAID
POWER CRIMP COUPLINGS
FIELD ATTACHABLE G1 & G2 COUPLINGS
FIELD ATTACHABLE C5 COUPLINGS
C14 COUPLINGS
GL COUPLINGS
GLX COUPLINGS
PCTS THERMOPLASTIC COUPLINGS
POLARSEAL COUPLINGS (ACA)
POLARSEAL II COUPLINGS (ACC)
POLARSEAL II COUPLINGS (ACB)
POWER STEERING
ADAPTERS
QUICK DISCONNECT COUPLERS
BALL VALVES
LIVE SWIVEL
ASSEMBLY FABRICATION
ACCESSORIES
EQUIPMENT AND PARTS
KITS
AIR BRAKE HOSE ASSY
BRASS



### Female Japanese Industrial Standard 30° Flare Swivel

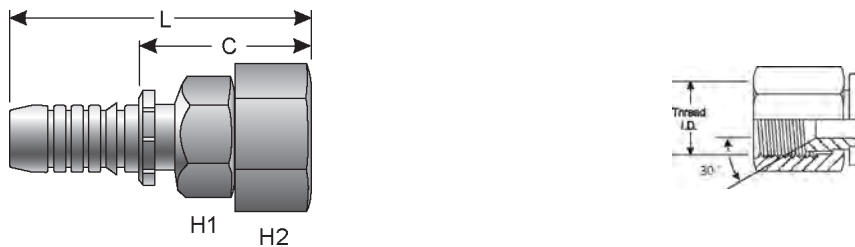

Part No.	Descr.	Prod. No.	⊖		H1	H2	L		C		
			"	mm			"	mm	"	mm	"
G22930-2424	24GSP-24FJISX	7347-79345	1 1/2	38.1	1 1/2-11	54	54	5.61	142.5	2.72	69.1

### GSP Ferrule for Wire Braid Hose

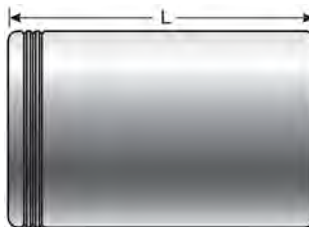

Part No.	Descr.	Prod. No.	⊖		L		⊕	
			"	mm	"	mm	"	mm
G22995-0224	24GSP1F-2	7347-03165	1 1/2	38.1	2.98	75.7	2.76	70.1
G22995-0232	32GSP1F-2	7347-03185	2	50.8	3.54	89.9	3.29	83.6

### GSP Ferrule for 4-Spiral Hose

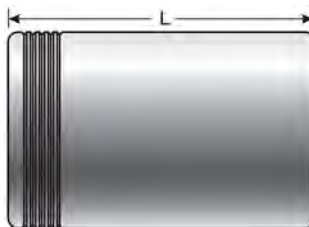

Part No.	Descr.	Prod. No.	⊖		L		⊕	
			"	mm	"	mm	"	mm
G22995-0424	24GSP1F-4	7347-03175	1 1/2	38.1	3.01	76.5	2.83	71.9
G22995-0432	32GSP1F-4	7347-03195	2	50.8	3.58	90.9	3.35	85.1

- EQUIPMENT
- HOSE/CPLG. SELECTION
- G8K COUPLINGS
- GLOBALSPIRAL COUPLINGS
- STAINLESS STEEL SPIRAL
- MEGACRIMP COUPLINGS
- STAINLESS STEEL BRAID
- POWER CRIMP COUPLINGS
- FIELD ATTACHABLE G1 & G2 COUPLINGS
- FIELD ATTACHABLE C5 COUPLINGS
- C14 COUPLINGS
- GL COUPLINGS
- GLX COUPLINGS
- PCTS THERMOPLASTIC COUPLINGS
- POLARSEAL COUPLINGS (ACA)
- POLARSEAL II COUPLINGS (ACC)
- POLARSEAL II COUPLINGS (ACB)
- POWER STEERING
- ADAPTERS
- QUICK DISCONNECT COUPLERS
- BALL VALVES
- LIVE SWIVEL
- ASSEMBLY FABRICATION
- ACCESSORIES
- EQUIPMENT AND PARTS
- KITS
- AIR BRAKE HOSE ASSY
- BRASS



EQUIPMENT
HOSE/CPLG. SELECTION
G8K COUPLINGS
<b>GLOBALSPIRAL COUPLINGS</b>
STAINLESS STEEL SPIRAL
MEGACRIMP COUPLINGS
STAINLESS STEEL BRAID
POWER CRIMP COUPLINGS
FIELD ATTACHABLE G1 & G2 COUPLINGS
FIELD ATTACHABLE C5 COUPLINGS
C14 COUPLINGS
GL COUPLINGS
GLX COUPLINGS
PCTS THERMOPLASTIC COUPLINGS
POLARSEAL COUPLINGS (ACA)
POLARSEAL II COUPLINGS (ACC)
POLARSEAL II COUPLINGS (ACB)
POWER STEERING
ADAPTERS
QUICK DISCONNECT COUPLERS
BALL VALVES
LIVE SWIVEL
ASSEMBLY FABRICATION
ACCESSORIES
EQUIPMENT AND PARTS
KITS
AIR BRAKE HOSE ASSY
BRASS

### Male Pipe (NPTF - 30° Cone Seat)



Part No.	Descr.	Prod. No.	⊖		H1	L		C		
			"	mm		"	"	mm	"	mm
G24100-2424	24GSM-24MP	7341-02585	1 1/2	38.1	1 1/2-11 1/2	2	6.51	165.4	2.77	70.4
G23100-3232	32GSM-32MP	7341-20405	2	50.8	2-11 1/2	2.75	7.54	191.6	3.05	77.6

### API Line Pipe Connection

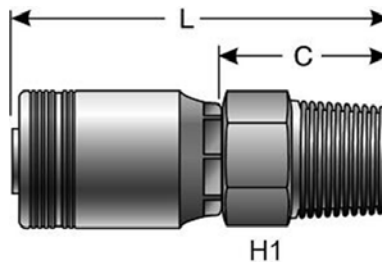

Part No.	Descr.	Prod. No.	⊖		H1	L		C		
			"	mm		"	"	mm	"	mm
G24102-2424	24GSM-24API-LP	7341-02735	1 1/2	38.1	1 1/2-11	2	5.76	146.3	2.23	56.6
G23102-3232	32GSM-32API-LP	7341-20305	2	50.8	2	2.75	9.39	238.4	4.90	124.4
G24102-4040	40GSM-40API-LP	7341-20675	2 1/2	63.5	2 1/2	—	12.40	316.0	5.47	138.9
G24102-4848	48GSM-48API-LP	7341-20715	3	76.2	3	—	14.10	359.0	6.38	162.0

### Male JIC 37° Flare

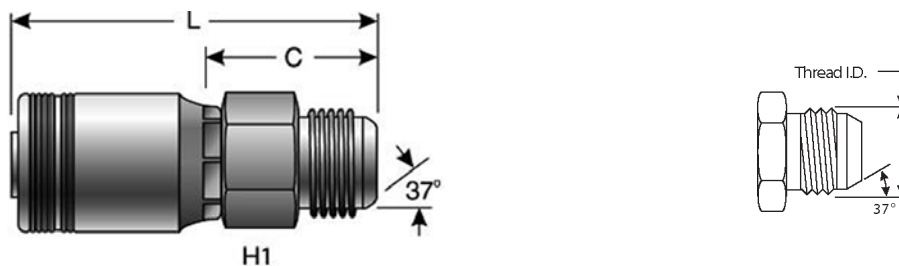

Part No.	Descr.	Prod. No.	⊖		H1	L		C		
			"	mm		"	"	mm	"	mm
G24165-2424	24GSM-24MJ	7341-02555	1 1/2	38.1	1 7/8-12	1.97	6.39	162.3	2.65	67.3
G23165-3232	32GSM-32MJ	7341-20465	2	50.8	2 1/2-12	2.56	7.72	196.1	3.23	82.1



### Female JIC 37° Flare Swivel

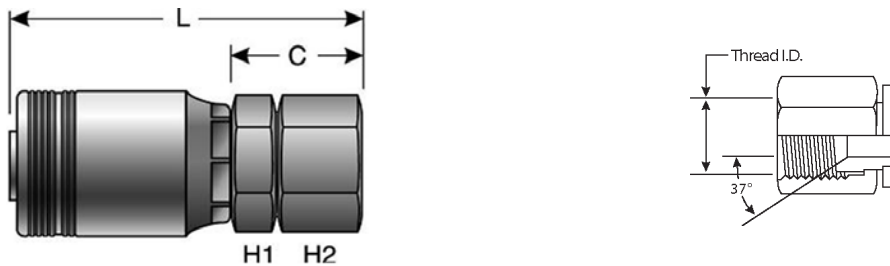

Part No.	Descr.	Prod. No.	⊖		🌀	H1	H2	L		C	
			"	mm				"	mm	"	mm
G24170-2424	24GSM-24FJX	7341-02525	1 1/2	38.1	1 7/8-12	2.17	2.36	6.78	172.2	3.04	77.2
G23170-3232	32GSM-32FJX	7341-20455	2	50.8	2 1/2-12	2.76	2.95	8.07	205.1	3.59	91.1

### Female JIC 37° Flare Swivel - 45° Bent Tube

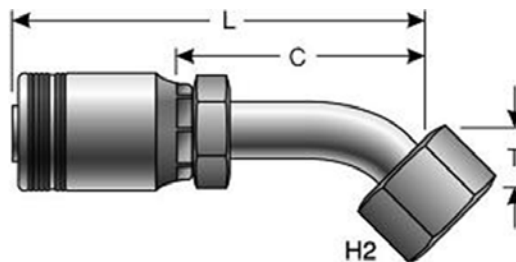

Part No.	Descr.	Prod. No.	⊖		🌀	H2	T		L		C	
			"	mm			mm	"	mm	"	mm	
G24174-2424	24GSM-24FJX45-034	7341-02535	1 1/2	38.1	1 7/8-12	60	1.34	34.0	8.90	226.1	5.15	130.8

### Female JIC 37° Flare Swivel - 90° Bent Tube

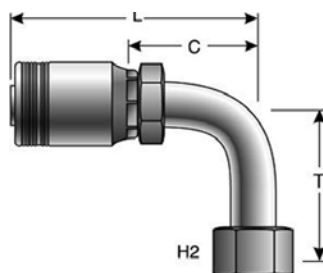

Part No.	Descr.	Prod. No.	⊖		🌀	H2	T		L		C	
			"	mm			mm	"	mm	"	mm	
G24180-2424	24GSM-24FJX90M	7341-02545	1 1/2	38.1	1 7/8-12	60	3.39	86.1	8.96	227.6	7.18	182.4

EQUIPMENT
HOSE/CPLG. SELECTION
G8K COUPLINGS
GLOBALSPIRAL COUPLINGS
STAINLESS STEEL SPIRAL
MEGACRIMP COUPLINGS
STAINLESS STEEL BRAID
POWER CRIMP COUPLINGS
FIELD ATTACHABLE G1 & G2 COUPLINGS
FIELD ATTACHABLE C5 COUPLINGS
C14 COUPLINGS
GL COUPLINGS
GLX COUPLINGS
PCTS THERMOPLASTIC COUPLINGS
POLARSEAL COUPLINGS (ACA)
POLARSEAL II COUPLINGS (ACC)
POLARSEAL II COUPLINGS (ACB)
POWER STEERING
ADAPTERS
QUICK DISCONNECT COUPLERS
BALL VALVES
LIVE SWIVEL
ASSEMBLY FABRICATION
ACCESSORIES
EQUIPMENT AND PARTS
KITS
AIR BRAKE HOSE ASSY
BRASS



EQUIPMENT
HOSE/CPLG. SELECTION
G8K COUPLINGS
GLOBALSPIRAL COUPLINGS
STAINLESS STEEL SPIRAL
MEGACRIMP COUPLINGS
STAINLESS STEEL BRAID
POWER CRIMP COUPLINGS
FIELD ATTACHABLE G1 & G2 COUPLINGS
FIELD ATTACHABLE C5 COUPLINGS
C14 COUPLINGS
GL COUPLINGS
GLX COUPLINGS
PCTS THERMOPLASTIC COUPLINGS
POLARSEAL COUPLINGS (ACA)
POLARSEAL II COUPLINGS (ACC)
POLARSEAL II COUPLINGS (ACB)
POWER STEERING
ADAPTERS
QUICK DISCONNECT COUPLERS
BALL VALVES
LIVE SWIVEL
ASSEMBLY FABRICATION
ACCESSORIES
EQUIPMENT AND PARTS
KITS
AIR BRAKE HOSE ASSY
BRASS

### Female Flat-Face Swivel

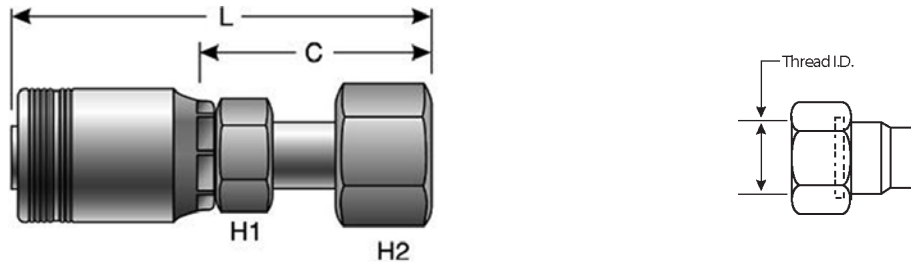

Part No.	Descr.	Prod. No.	⊖		🌀	H1	H2	L		C	
			"	mm				"	mm	"	mm
G24230-2424	24GSM4K-24FFORX	7341-02445	1 1/2	38.1	2-12	2.17	2.36	6.47	164.3	2.73	69.3
G23230-3232	32GSM-32FFORX	7341-20485	2	50.8	2 1/2-12	2.76	2.95	7.60	193.0	3.07	79.0

### Female Flat-Face Swivel - 45° Bent Tube

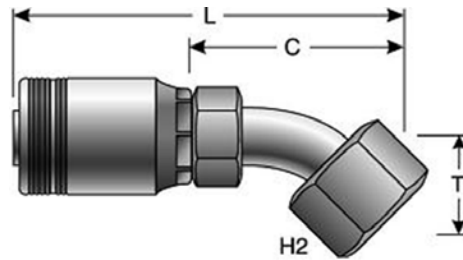

Part No.	Descr.	Prod. No.	⊖		🌀	H2	T		L		C	
			"	mm			"	mm	"	mm	"	mm
G24234-2424	24GSM4K-24FFORX45-038	7341-02455	1 1/2	38.1	2-12	60	1.50	38.1	9.31	236.6	5.56	141.1

### Female Flat-Face Swivel - 90° Bent Tube

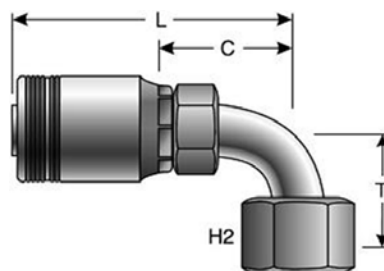

Part No.	Descr.	Prod. No.	⊖		🌀	H2	T		L		C	
			"	mm			"	mm	"	mm	"	mm
G24240-2424	24GSM4K-24FFORX90M	7341-02475	1 1/2	38.1	2-12	2.50	3.41	86.6	8.48	215.4	3.69	93.7



### Code 61 O-Ring Flange

-24FL and -32FL Max. W.P. 3,000 psi; -40FL Max. W.P. 2,500 psi.

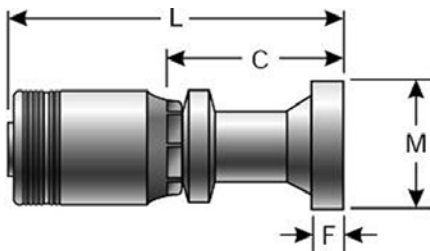

Part No.	Descr.	Prod. No.	⌀		M		L		C		F	
			"	mm	"	mm	"	mm	"	mm	"	mm
G24300-2424	24GSM-24FL	7341-01905	1 1/2	38.1	2.38	60.5	7.09	180.1	3.35	85.1	.32	8.1
G24300-2432	24GSM-32FL	7341-01915	1 1/2	38.1	2.81	71.4	7.40	188.0	3.66	93.0	.38	9.7
G23300-3232	32GSM-32FL	7341-20255	2	50.8	2.81	71.4	9.90	251.4	5.41	137.4	.38	9.7
G24300-4040	40GSM-40FL	7341-20905	2 1/2	63.5	3.31	84.1	11.81	300.0	4.80	122.9	.38	9.7

### Code 61 O-Ring Flange - 30° Bent Tube

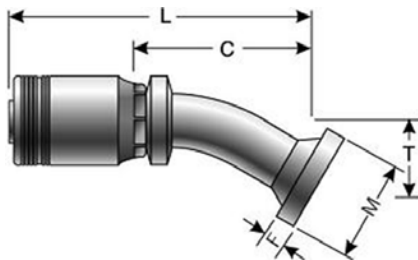

Part No.	Descr.	Prod. No.	⌀		M		T		L		C		F	
			"	mm	"	mm	"	mm	"	mm	"	mm	"	mm
G24304-2424	24GSM-24FL30M	7341-01925	1 1/2	38.1	2.38	60.5	1.77	45.0	8.52	216.4	5.00	127.0	.32	8.1

- EQUIPMENT
- HOSE/CPLG. SELECTION
- G8K COUPLINGS
- GLOBALSPIRAL COUPLINGS
- STAINLESS STEEL SPIRAL
- MEGACRIMP COUPLINGS
- STAINLESS STEEL BRAID
- POWER CRIMP COUPLINGS
- FIELD ATTACHABLE G1 & G2 COUPLINGS
- FIELD ATTACHABLE C5 COUPLINGS
- C14 COUPLINGS
- GL COUPLINGS
- GLX COUPLINGS
- PCTS THERMOPLASTIC COUPLINGS
- POLARSEAL COUPLINGS (ACA)
- POLARSEAL II COUPLINGS (ACC)
- POLARSEAL II COUPLINGS (ACB)
- POWER STEERING
- ADAPTERS
- QUICK DISCONNECT COUPLERS
- BALL VALVES
- LIVE SWIVEL
- ASSEMBLY FABRICATION
- ACCESSORIES
- EQUIPMENT AND PARTS
- KITS
- AIR BRAKE HOSE ASSY
- BRASS





EQUIPMENT
HOSE/CPLG. SELECTION
G8K COUPLINGS
GLOBALSPIRAL COUPLINGS
STAINLESS STEEL SPIRAL
MEGACRIMP COUPLINGS
STAINLESS STEEL BRAID
POWER CRIMP COUPLINGS
FIELD ATTACHABLE G1 & G2 COUPLINGS
FIELD ATTACHABLE C5 COUPLINGS
C14 COUPLINGS
GL COUPLINGS
GLX COUPLINGS
PCTS THERMOPLASTIC COUPLINGS
POLARSEAL COUPLINGS (ACA)
POLARSEAL II COUPLINGS (ACC)
POLARSEAL II COUPLINGS (ACB)
POWER STEERING
ADAPTERS
QUICK DISCONNECT COUPLERS
BALL VALVES
LIVE SWIVEL
ASSEMBLY FABRICATION
ACCESSORIES
EQUIPMENT AND PARTS
KITS
AIR BRAKE HOSE ASSY
BRASS

### Code 61 O-Ring Flange - 45° Bent Tube

Maximum working pressure 3,000 psi.

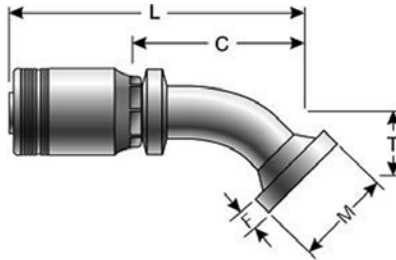

Part No.	Descr.	Prod. No.	⊖		M		T		L		C		F	
			"	mm	"	mm	"	mm	"	mm	"	mm	"	mm
G24307-2424	24GSM-24FL45M	7341-01945	1 1/2	38.1	2.38	60.5	1.73	43.9	9.05	229.9	5.31	134.9	.32	8.1
G24306-2432	24GSM-32FL45S	7341-01955	1 1/2	38.1	2.81	71.4	2.05	52.1	9.13	231.9	5.34	136.6	.38	9.7
G23307-3232	32GSM-32FL45M	7341-20265	2	50.8	2.81	71.4	2.20	56.0	11.30	288.0	6.83	173.6	.38	9.7

### Code 61 O-Ring Flange - 60° Bent Tube

Maximum working pressure 3,000 psi.

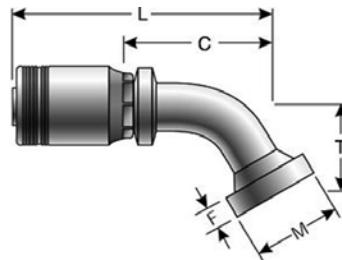

Part No.	Descr.	Prod. No.	⊖		M		T		L		C		F	
			"	mm	"	mm	"	mm	"	mm	"	mm	"	mm
G24309-2424	24GSM-24FL60M	7341-01965	1 1/2	38.1	2.38	60.5	2.52	64.0	9.50	241.3	5.75	146.1	.32	8.1



### Code 61 O-Ring Flange - 90° Bent Tube

Maximum working pressure 3,000 psi.

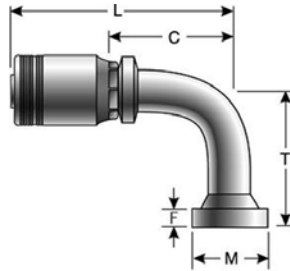

Part No.	Descr.	Prod. No.	⊘		M		T		L		C		F	
			"	mm	"	mm	"	mm	"	mm	"	mm	"	mm
G24314-2424	24GSM-24FL90S	7341-01985	1 1/2	38.1	2.38	60.5	3.19	81.0	8.46	214.9	4.72	119.9	.32	8.1
G23314-3232	32GSM-32FL90-130	7341-20275	2	50.8	2.81	71.4	5.12	130.0	10.43	265.0	5.93	150.5	.38	9.7

### Code 62 O-Ring Flange Heavy

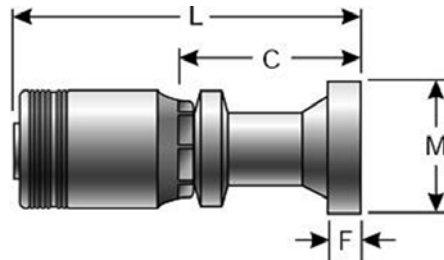

Part No.	Descr.	Prod. No.	⊘		M		L		C		F	
			"	mm	"	mm	"	mm	"	mm	"	mm
G24350-2420	24GSM-20FLH	7341-02245	1 1/2	38.1	2.13	54.1	7.87	199.9	4.13	104.9	.41	10.4
G24350-2424	24GSM-24FLH	7341-02255	1 1/2	38.1	2.50	63.5	7.87	199.9	4.13	104.9	.50	12.7
G24350-2432	24GSM-32FLH	7341-02265	1 1/2	38.1	3.13	79.5	7.87	199.9	4.13	104.9	.50	12.7
G23350-3224	32GSM-24FLH	7341-20095	2	50.8	2.50	63.5	9.06	230.0	4.57	116.0	.50	12.7
G23350-3232	32GSM-32FLH	7341-20005	2	50.8	3.13	79.5	9.90	251.4	5.41	137.4	.50	12.7

EQUIPMENT
HOSE/CPLG. SELECTION
G8K COUPLINGS
GLOBALSPIRAL COUPLINGS
STAINLESS STEEL SPIRAL
MEGACRIMP COUPLINGS
STAINLESS STEEL BRAID
POWER CRIMP COUPLINGS
FIELD ATTACHABLE G1 & G2 COUPLINGS
FIELD ATTACHABLE C5 COUPLINGS
C14 COUPLINGS
GL COUPLINGS
GLX COUPLINGS
PCTS THERMOPLASTIC COUPLINGS
POLARSEAL COUPLINGS (ACA)
POLARSEAL II COUPLINGS (ACC)
POLARSEAL II COUPLINGS (ACB)
POWER STEERING
ADAPTERS
QUICK DISCONNECT COUPLERS
BALL VALVES
LIVE SWIVEL
ASSEMBLY FABRICATION
ACCESSORIES
EQUIPMENT AND PARTS
KITS
AIR BRAKE HOSE ASSY
BRASS



EQUIPMENT
HOSE/CPLG. SELECTION
G8K COUPLINGS
<b>GLOBALSPIRAL COUPLINGS</b>
STAINLESS STEEL SPIRAL
MEGACRIMP COUPLINGS
STAINLESS STEEL BRAID
POWER CRIMP COUPLINGS
FIELD ATTACHABLE G1 & G2 COUPLINGS
FIELD ATTACHABLE C5 COUPLINGS
C14 COUPLINGS
GL COUPLINGS
GLX COUPLINGS
PCTS THERMOPLASTIC COUPLINGS
POLARSEAL COUPLINGS (ACA)
POLARSEAL II COUPLINGS (ACC)
POLARSEAL II COUPLINGS (ACB)
POWER STEERING
ADAPTERS
QUICK DISCONNECT COUPLERS
BALL VALVES
LIVE SWIVEL
ASSEMBLY FABRICATION
ACCESSORIES
EQUIPMENT AND PARTS
KITS
AIR BRAKE HOSE ASSY
BRASS

### Code 62 O-Ring Flange Heavy - 22° Bent Tube

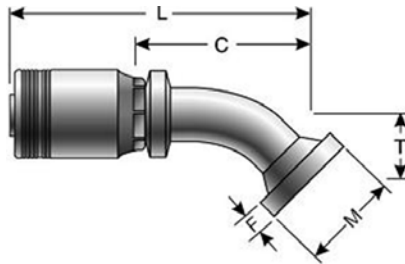

Part No.	Descr.	Prod. No.	⊖		M		T		L		C		F	
			"	mm	"	mm	"	mm	"	mm	"	mm	"	mm
G24352-2424	24GSM-24FLH22M	7341-02275	1 1/2	38.1	2.50	63.5	.70	17.9	9.56	242.8	5.84	148.4	.50	12.7
G24353-2424	24GSM-24FLH20-024	7341-02395	1 1/2	38.1	2.50	63.5	.94	23.9	9.56	242.8	5.81	147.6	.50	12.7

### Code 62 O-Ring Flange Heavy - 30° Bent Tube

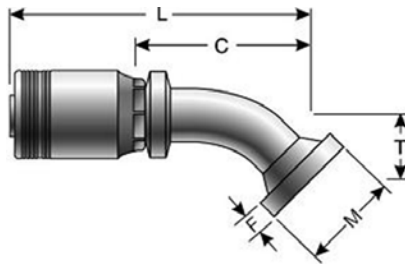

Part No.	Descr.	Prod. No.	⊖		M		T		L		C		F	
			"	mm	"	mm	"	mm	"	mm	"	mm	"	mm
G24354-2424	24GSM-24FLH30M	7341-02295	1 1/2	38.1	2.50	63.5	3.54	89.9	9.45	240.0	5.70	144.8	.50	12.7
G24355-2424	24GSM-24FLH30-28	7341-02305	1 1/2	38.1	2.50	63.5	1.10	27.9	8.86	225.0	5.12	130.0	.50	12.7
G23354-3232	32GSM-32FLH30-040	7341-20065	2	50.8	3.13	79.5	1.57	40.0	12.17	309.0	7.66	194.6	.50	12.7

### Code 62 O-Ring Flange Heavy - 45° Bent Tube

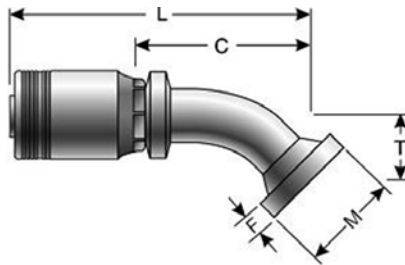

Part No.	Descr.	Prod. No.	⊖		M		T		L		C		F	
			"	mm	"	mm	"	mm	"	mm	"	mm	"	mm
G24357-2424	24GSM-24FLH45M	7341-02315	1 1/2	38.1	2.50	63.5	1.73	43.9	9.13	231.9	5.39	136.9	.50	12.7
G24357-2432	24GSM-32FLH45M	7341-02325	1 1/2	38.1	3.13	79.5	2.20	55.9	9.48	240.8	5.74	146.0	.50	12.7



Code 62 O-Ring Flange Heavy - 45° Bent Tube - Continued

Part No.	Descr.	Prod. No.	⊕		M		T		L		C		F	
			"	mm	"	mm	"	mm	"	mm	"	mm	"	mm
G23357-3232	32GSM-32FLH45-063	7341-20055	2	50.8	3.13	79.5	2.48	63.0	11.69	297.0	6.00	152.5	.50	12.7

Code 62 O-Ring Flange Heavy - 60° Bent Tube

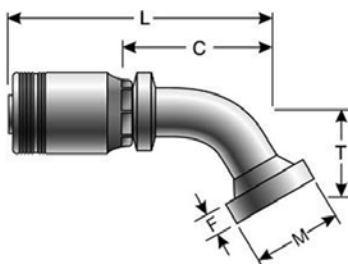

Part No.	Descr.	Prod. No.	⊕		M		T		L		C		F	
			"	mm	"	mm	"	mm	"	mm	"	mm	"	mm
G24359-2424	24GSM-24FLH60M	7341-02335	1 1/2	38.1	2.50	63.5	2.50	63.5	9.25	235.0	6.23	158.2	.50	12.7
G23359-3232	32GSM-32FLH60M	7341-20075	2	50.8	3.13	79.5	3.27	83.1	12.28	311.9	7.77	197.4	.50	12.7

Code 62 O-Ring Flange Heavy - 90° Bent Tube

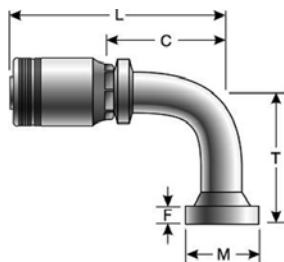

Part No.	Descr.	Prod. No.	⊕		M		T		L		C		F	
			"	mm	"	mm	"	mm	"	mm	"	mm	"	mm
G24365-2424	24GSM-24FLH90-094	7341-02355	1 1/2	38.1	2.50	63.5	3.70	94.0	8.73	221.7	4.68	118.9	.50	12.7
G24366-2424	24GSM-24FLH90-150	7341-02375	1 1/2	38.1	2.50	63.5	5.90	149.9	8.42	213.9	4.68	118.9	.50	12.7
G24365-2432	24GSM-32FLH90S	7341-02365	1 1/2	38.1	3.13	79.5	4.72	119.9	8.42	213.9	4.68	118.9	.50	12.7
G23364-3232	32GSM-32FLH90S	7341-20085	2	50.8	3.13	79.5	4.72	120.0	10.41	264.0	5.91	150.0	.50	12.7
G23365-3232	32GSM-32FLH90M	7341-20045	2	50.8	3.13	79.5	5.43	138.0	10.41	264.0	5.91	150.0	.50	12.7
G23366-3232	32GSM-32FLH90-159	7341-20035	2	50.8	3.13	79.5	6.26	159.0	10.41	264.0	5.92	150.4	.50	12.7

EQUIPMENT
HOSE/CPLG. SELECTION
G8K COUPLINGS
GLOBALSPIRAL COUPLINGS
STAINLESS STEEL SPIRAL
MEGACRIMP COUPLINGS
STAINLESS STEEL BRAID
POWER CRIMP COUPLINGS
FIELD ATTACHABLE G1 & G2 COUPLINGS
FIELD ATTACHABLE C5 COUPLINGS
C14 COUPLINGS
GL COUPLINGS
GLX COUPLINGS
PCTS THERMOPLASTIC COUPLINGS
POLARSEAL COUPLINGS (ACA)
POLARSEAL II COUPLINGS (ACC)
POLARSEAL II COUPLINGS (ACB)
POWER STEERING
ADAPTERS
QUICK DISCONNECT COUPLERS
BALL VALVES
LIVE SWIVEL
ASSEMBLY FABRICATION
ACCESSORIES
EQUIPMENT AND PARTS
KITS
AIR BRAKE HOSE ASSY
BRASS



EQUIPMENT
HOSE/CPLG. SELECTION
G8K COUPLINGS
GLOBALSPIRAL COUPLINGS
STAINLESS STEEL SPIRAL
MEGACRIMP COUPLINGS
STAINLESS STEEL BRAID
POWER CRIMP COUPLINGS
FIELD ATTACHABLE G1 & G2 COUPLINGS
FIELD ATTACHABLE C5 COUPLINGS
C14 COUPLINGS
GL COUPLINGS
GLX COUPLINGS
PCTS THERMOPLASTIC COUPLINGS
POLARSEAL COUPLINGS (ACA)
POLARSEAL II COUPLINGS (ACC)
POLARSEAL II COUPLINGS (ACB)
POWER STEERING
ADAPTERS
QUICK DISCONNECT COUPLERS
BALL VALVES
LIVE SWIVEL
ASSEMBLY FABRICATION
ACCESSORIES
EQUIPMENT AND PARTS
KITS
AIR BRAKE HOSE ASSY
BRASS

### Code 62 O-Ring Flange Heavy with Captive Flange

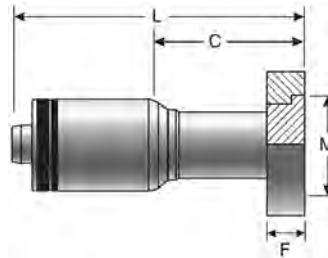

Part No.	Descr.	Prod. No.	⊖		M		L		C		F	
			"	mm	"	mm	"	mm	"	mm	"	mm
G24374-2424	24GSM-24FLHCFM	7341-02805	1 1/2	38.1	2.50	63.5	7.87	200.0	4.13	105.0	.50	2.5
G23374-3232	32GSM-32FLHCFM	7341-20135	2	50.8	3.13	79.5	9.90	251.4	5.41	137.4	.50	3.1

### Code 62 O-Ring Flange Heavy with Captive Flange - 45° Bent Tube

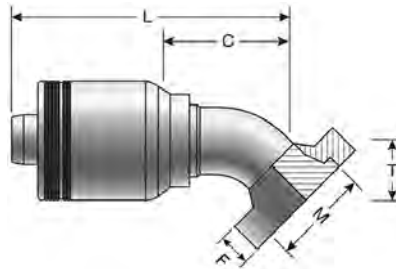

Part No.	Descr.	Prod. No.	⊖		M		T		L		C		F	
			"	mm	"	mm	"	mm	"	mm	"	mm	"	mm
G24376-2424	24GSM-24FLHCFM45M	7341-02815	1 1/2	38.1	2.50	63.5	1.73	44.0	9.13	232.0	5.39	137.0	.50	2.5
G23376-3232	32GSM-32FLHCFM45-063	7341-20145	2	50.8	3.13	79.5	2.48	63.0	11.69	297.0	7.18	182.5	.50	3.1

### Code 62 O-Ring Flange Heavy with Captive Flange - 90° Bent Tube

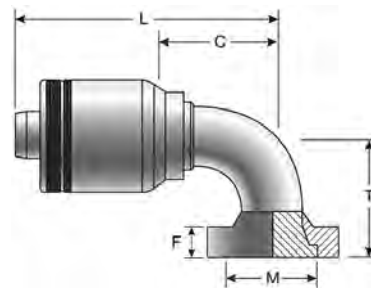

Part No.	Descr.	Prod. No.	⊖		M		T		L		C		F	
			"	mm	"	mm	"	mm	"	mm	"	mm	"	mm
G24380-2424	24GSM-24FLHCFM90-094	7341-02825	1 1/2	38.1	2.50	63.5	3.70	94.0	8.43	214.0	4.69	119.0	.50	2.5



Code 62 O-Ring Flange Heavy with Captive Flange - 90° Bent Tube - Continued

Part No.	Descr.	Prod. No.	⊖		M		T		L		C		F	
			"	mm	"	mm	"	mm	"	mm	"	mm	"	mm
G23380-3232	32GSM-32FLHCFM90-120	7341-20155	2	50.8	3.13	79.5	4.72	120.0	10.39	264.0	5.91	150.0	.50	3.1

Code 62 O-Ring Flange Heavy Captive Flange Metric Bolts

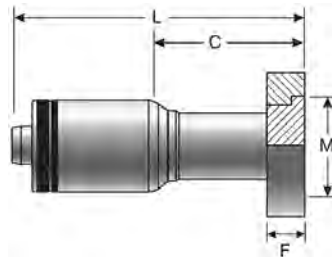

Part No.	Descr.	Prod. No.	⊖		M		L		C		F	
			"	mm	"	mm	"	mm	"	mm	"	mm
G24386-4040	40GSM-40FLHCFM	7341-20655	2 1/2	63.5	5.91	150.0	15.00	380.0	7.95	202.0	1.89	48.0
G24386-4848	48GSM-48FLHCFM	7341-20695	3	76.2	8.27	210.0	17.30	440.0	9.57	243.0	2.28	58.0

Caterpillar Style O-Ring Flange

NOTE: These FLC flanges are designed with a thicker flange head. The .56" flange dimension is frequently found on Caterpillar equipment. These flanges let the user utilize the existing Caterpillar flange halves or new Gates Caterpillar flange halves. At the user's option, standard Code 62 flanges and halves can be used in place of Caterpillar flanges and halves. The standard Code 62 flange head thickness ranges between .305" and .495". Compatible with Code 62 O-Ring. See Accessories for recommended O-Rings. (Do Not use "D" shaped O-Rings).

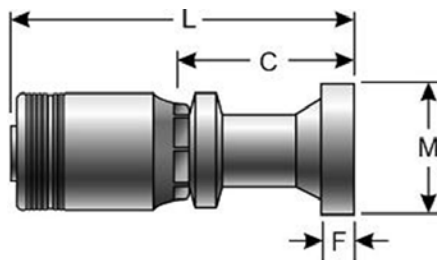

Part No.	Descr.	Prod. No.	⊖		M		L		C		F	
			"	mm	"	mm	"	mm	"	mm	"	mm
G24400-2424	24GSM-24FLC	7341-02055	1 1/2	38.1	2.50	63.5	7.44	189.0	3.71	94.2	.56	14.2
G24401-2424	24GSM-24FLCL	7341-02175	1 1/2	38.1	2.50	63.5	9.37	238.0	5.64	143.3	.56	14.2
G24400-2432	24GSM-32FLC	7341-02065	1 1/2	38.1	3.13	79.5	7.87	199.9	4.13	104.9	.56	14.2
G23400-3232	32GSM-32FLC	7341-20205	2	50.8	3.13	79.5	8.97	227.7	4.48	113.8	.56	14.2

EQUIPMENT
HOSE/CPLG. SELECTION
G8K COUPLINGS
GLOBALSPIRAL COUPLINGS
STAINLESS STEEL SPIRAL
MEGACRIMP COUPLINGS
STAINLESS STEEL BRAID
POWER CRIMP COUPLINGS
FIELD ATTACHABLE G1 & G2 COUPLINGS
FIELD ATTACHABLE C5 COUPLINGS
C14 COUPLINGS
GL COUPLINGS
GLX COUPLINGS
PCTS THERMOPLASTIC COUPLINGS
POLARSEAL COUPLINGS (ACA)
POLARSEAL II COUPLINGS (ACC)
POLARSEAL II COUPLINGS (ACB)
POWER STEERING
ADAPTERS
QUICK DISCONNECT COUPLERS
BALL VALVES
LIVE SWIVEL
ASSEMBLY FABRICATION
ACCESSORIES
EQUIPMENT AND PARTS
KITS
AIR BRAKE HOSE ASSY
BRASS



EQUIPMENT
HOSE/CPLG. SELECTION
G8K COUPLINGS
GLOBALSPIRAL COUPLINGS
STAINLESS STEEL SPIRAL
MEGACRIMP COUPLINGS
STAINLESS STEEL BRAID
POWER CRIMP COUPLINGS
FIELD ATTACHABLE G1 & G2 COUPLINGS
FIELD ATTACHABLE C5 COUPLINGS
C14 COUPLINGS
GL COUPLINGS
GLX COUPLINGS
PCTS THERMOPLASTIC COUPLINGS
POLARSEAL COUPLINGS (ACA)
POLARSEAL II COUPLINGS (ACC)
POLARSEAL II COUPLINGS (ACB)
POWER STEERING
ADAPTERS
QUICK DISCONNECT COUPLERS
BALL VALVES
LIVE SWIVEL
ASSEMBLY FABRICATION
ACCESSORIES
EQUIPMENT AND PARTS
KITS
AIR BRAKE HOSE ASSY
BRASS

### Caterpillar Style O-Ring Flange - 22° Bent Tube

NOTE: These FLC flanges are designed with a thicker flange head. The .56" flange dimension is frequently found on Caterpillar equipment. These flanges let the user utilize the existing Caterpillar flange halves or new Gates Caterpillar flange halves. At the user's option, standard Code 62 flanges and halves can be used in place of Caterpillar flanges and halves. The standard Code 62 flange head thickness ranges between .305" and .495". Compatible with Code 62 O-Ring. See Accessories for recommended O-Rings. (Do Not use "D" shaped O-Rings).

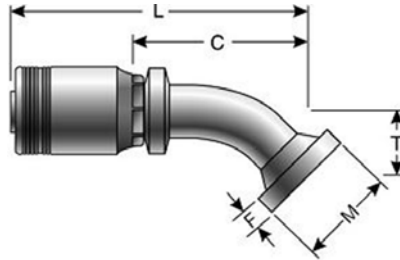

Part No.	Descr.	Prod. No.	⊖		M		T		L		C		F	
			"	mm	"	mm	"	mm	"	mm	"	mm	"	mm
G24402-2424	24GSM-24FLC22-017	7341-02075	1 1/2	38.1	2.50	63.5	.66	16.8	9.29	236.0	5.57	141.5	.56	14.2
G24402-2432	24GSM-32FLC22-022	7341-02085	1 1/2	38.1	3.13	79.5	.87	22.1	7.87	261.0	4.13	104.9	.56	14.2

### Caterpillar Style O-Ring Flange - 30° Bent Tube

NOTE: These FLC flanges are designed with a thicker flange head. The .56" flange dimension is frequently found on Caterpillar equipment. These flanges let the user utilize the existing Caterpillar flange halves or new Gates Caterpillar flange halves. At the user's option, standard Code 62 flanges and halves can be used in place of Caterpillar flanges and halves. The standard Code 62 flange head thickness ranges between .305" and .495". Compatible with Code 62 O-Ring. See Accessories for recommended O-Rings. (Do Not use "D" shaped O-Rings).

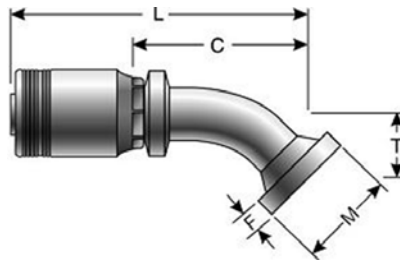

Part No.	Descr.	Prod. No.	⊖		M		T		L		C		F	
			"	mm	"	mm	"	mm	"	mm	"	mm	"	mm
G24404-2424	24GSM-24FLC30-023	7341-02095	1 1/2	38.1	2.50	63.5	.90	22.9	9.25	235.0	5.49	139.5	.56	14.2
G24404-2432	24GSM-32FLC30-035	7341-02105	1 1/2	38.1	3.13	79.5	1.37	34.8	10.11	257.0	6.36	161.6	.56	14.2
G23404-3232	32GSM-32FLC30-035	7341-20245	2	50.8	3.13	79.5	1.38	35.0	11.85	301.2	7.37	187.2	.56	14.2





### Caterpillar Style O-Ring Flange - 45° Bent Tube

NOTE: These FLC flanges are designed with a thicker flange head. The .56" flange dimension is frequently found on Caterpillar equipment. These flanges let the user utilize the existing Caterpillar flange halves or new Gates Caterpillar flange halves. At the user's option, standard Code 62 flanges and halves can be used in place of Caterpillar flanges and halves. The standard Code 62 flange head thickness ranges between .305" and .495". Compatible with Code 62 O-Ring. See Accessories for recommended O-Rings. (Do Not use "D" shaped O-Rings).

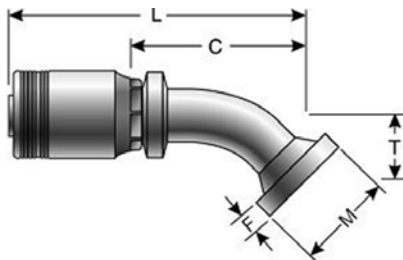

Part No.	Descr.	Prod. No.	⊖		M		T		L		C		F	
			"	mm	"	mm	"	mm	"	mm	"	mm	"	mm
G24407-2424	24GSM-24FLC45-039	7341-02115	1 1/2	38.1	2.50	63.5	1.54	39.1	8.94	227.1	5.20	132.1	.56	14.2
G24407-2432	24GSM-32FLC45-059	7341-02125	1 1/2	38.1	3.13	79.5	2.32	58.9	9.60	244.0	5.86	149.0	.56	14.2
G23407-3232	32GSM-32FLC45-064	7341-20215	2	50.8	3.13	79.5	2.52	64.0	11.32	287.5	6.83	173.5	.56	14.2

### Caterpillar Style O-Ring Flange - 60° Bent Tube

NOTE: These FLC flanges are designed with a thicker flange head. The .56" flange dimension is frequently found on Caterpillar equipment. These flanges let the user utilize the existing Caterpillar flange halves or new Gates Caterpillar flange halves. At the user's option, standard Code 62 flanges and halves can be used in place of Caterpillar flanges and halves. The standard Code 62 flange head thickness ranges between .305" and .495". Compatible with Code 62 O-Ring. See Accessories for recommended O-Rings. (Do Not use "D" shaped O-Rings).

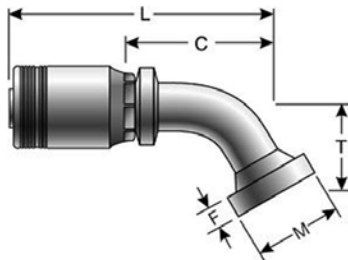

Part No.	Descr.	Prod. No.	⊖		M		T		L		C		F	
			"	mm	"	mm	"	mm	"	mm	"	mm	"	mm
G24409-2424	24GSM-24FLC60-055	7341-02135	1 1/2	38.1	2.50	63.5	2.17	55.1	9.91	251.7	6.17	156.7	.56	14.2
G24409-2432	24GSM-32FLC60-087	7341-02145	1 1/2	38.1	3.13	79.5	3.42	86.9	11.69	297.0	7.94	201.9	.56	14.2
G23409-3232	32GSM-32FLC60-083	7341-20225	2	50.8	3.13	79.5	3.27	83.1	12.69	322.3	8.17	207.5	.56	14.2

- EQUIPMENT
- HOSE/CPLG. SELECTION
- G8K COUPLINGS
- GLOBALSPIRAL COUPLINGS
- STAINLESS STEEL SPIRAL
- MEGACRIMP COUPLINGS
- STAINLESS STEEL BRAID
- POWER CRIMP COUPLINGS
- FIELD ATTACHABLE G1 & G2 COUPLINGS
- FIELD ATTACHABLE C5 COUPLINGS
- C14 COUPLINGS
- GL COUPLINGS
- GLX COUPLINGS
- PCTS THERMOPLASTIC COUPLINGS
- POLARSEAL COUPLINGS (ACA)
- POLARSEAL II COUPLINGS (ACC)
- POLARSEAL II COUPLINGS (ACB)
- POWER STEERING
- ADAPTERS
- QUICK DISCONNECT COUPLERS
- BALL VALVES
- LIVE SWIVEL
- ASSEMBLY FABRICATION
- ACCESSORIES
- EQUIPMENT AND PARTS
- KITS
- AIR BRAKE HOSE ASSY
- BRASS



### Caterpillar Style O-Ring Flange - 90° Bent Tube

NOTE: These FLC flanges are designed with a thicker flange head. The .56" flange dimension is frequently found on Caterpillar equipment. These flanges let the user utilize the existing Caterpillar flange halves or new Gates Caterpillar flange halves. At the user's option, standard Code 62 flanges and halves can be used in place of Caterpillar flanges and halves. The standard Code 62 flange head thickness ranges between .305" and .495". Compatible with Code 62 O-Ring. See Accessories for recommended O-Rings. (Do Not use "D" shaped O-Rings).

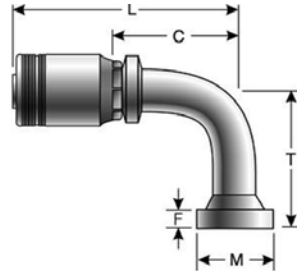

Part No.	Descr.	Prod. No.	⊖		M		T		L		C		F	
			"	mm	"	mm	"	mm	"	mm	"	mm	"	mm
G24415-2424	24GSM-24FLC90-087	7341-02155	1 1/2	38.1	2.50	63.5	3.43	87.1	8.43	214.1	4.70	119.4	.56	14.2
G24415-2432	24GSM-32FLC90-140	7341-02165	1 1/2	38.1	3.13	79.5	5.51	140.0	8.85	225.0	5.11	129.9	.56	14.2
G23415-3232	32GSM-32FLC90-130	7341-20235	2	50.8	3.13	79.5	5.12	130.0	10.41	264.5	5.93	150.5	.56	14.2

### Hose Length Extender

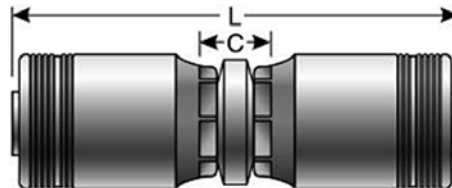

Part No.	Descr.	Prod. No.	⊖		L		C	
			"	mm	"	mm	"	mm
G23534-3232	32GSM-32HLE	7341-20475	2	50.8	11.11	282.0	2.14	54.4
G24534-4040	40GSM-40HLE	7341-20735	2 1/2	63.5	16.70	424.0	2.68	68.0
G24535-4848	48GSM-48HLE	7341-20745	3	76.2	18.40	468.0	2.91	73.9

EQUIPMENT
HOSE/CPLG. SELECTION
G8K COUPLINGS
GLOBALSPIRAL COUPLINGS
STAINLESS STEEL SPIRAL
MEGACRIMP COUPLINGS
STAINLESS STEEL BRAID
POWER CRIMP COUPLINGS
FIELD ATTACHABLE G1 & G2 COUPLINGS
FIELD ATTACHABLE C5 COUPLINGS
C14 COUPLINGS
GL COUPLINGS
GLX COUPLINGS
PCTS THERMOPLASTIC COUPLINGS
POLARSEAL COUPLINGS (ACA)
POLARSEAL II COUPLINGS (ACC)
POLARSEAL II COUPLINGS (ACB)
POWER STEERING
ADAPTERS
QUICK DISCONNECT COUPLERS
BALL VALVES
LIVE SWIVEL
ASSEMBLY FABRICATION
ACCESSORIES
EQUIPMENT AND PARTS
KITS
AIR BRAKE HOSE ASSY
BRASS



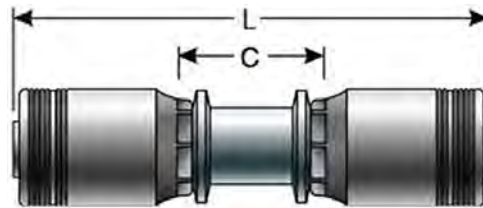

### Hose Length Extender for Caterpillar with Clamping Area

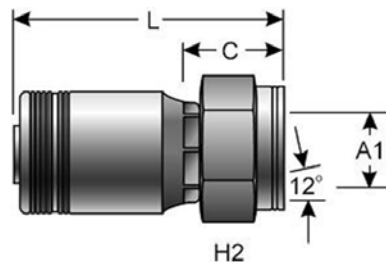

Part No.	Descr.	Prod. No.	⊖		L		C	
			"	mm	"	mm	"	mm
G24534-2424	24GSM-24HLEC	7341-02645	1 1/2	38.1	10.66	270.8	3.18	80.8

### Female DIN 24° Cone Swivel - Heavy Series with O-Ring



Part No.	Descr.	Prod. No.	⊖			H2	L		C		A1
			"	mm	"	mm	"	mm	"	mm	mm
G24720-2438	24GSM-38FDHORX	7341-07055	1 1/2	38.1	M52X2.0	60	7.09	180.1	3.35	85.1	38.0

### Female DIN 24° Cone Swivel - Heavy Series with O-Ring - 45° Bent Tube

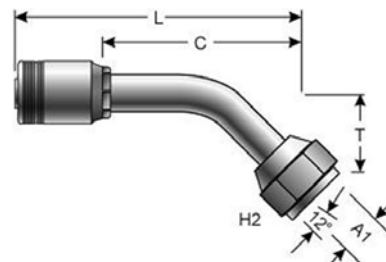

Part No.	Descr.	Prod. No.	⊖			H2	T		L		C		A1
			"	mm	"	mm	"	mm	"	mm	"	mm	mm
G24725-2438	24GSM-38FDHORX45	7341-07065	1 1/2	38.1	M52X2.0	60	1.74	44.2	9.33	237.0	5.59	142.0	38.0

EQUIPMENT
HOSE/CPLG. SELECTION
G8K COUPLINGS
GLOBALSPIRAL COUPLINGS
STAINLESS STEEL SPIRAL
MEGACRIMP COUPLINGS
STAINLESS STEEL BRAID
POWER CRIMP COUPLINGS
FIELD ATTACHABLE G1 & G2 COUPLINGS
FIELD ATTACHABLE C5 COUPLINGS
C14 COUPLINGS
GL COUPLINGS
GLX COUPLINGS
PCTS THERMOPLASTIC COUPLINGS
POLARSEAL COUPLINGS (ACA)
POLARSEAL II COUPLINGS (ACC)
POLARSEAL II COUPLINGS (ACB)
POWER STEERING
ADAPTERS
QUICK DISCONNECT COUPLERS
BALL VALVES
LIVE SWIVEL
ASSEMBLY FABRICATION
ACCESSORIES
EQUIPMENT AND PARTS
KITS
AIR BRAKE HOSE ASSY
BRASS



EQUIPMENT
HOSE/CPLG. SELECTION
G8K COUPLINGS
GLOBALSPIRAL COUPLINGS
STAINLESS STEEL SPIRAL
MEGACRIMP COUPLINGS
STAINLESS STEEL BRAID
POWER CRIMP COUPLINGS
FIELD ATTACHABLE G1 & G2 COUPLINGS
FIELD ATTACHABLE C5 COUPLINGS
C14 COUPLINGS
GL COUPLINGS
GLX COUPLINGS
PCTS THERMOPLASTIC COUPLINGS
POLARSEAL COUPLINGS (ACA)
POLARSEAL II COUPLINGS (ACC)
POLARSEAL II COUPLINGS (ACB)
POWER STEERING
ADAPTERS
QUICK DISCONNECT COUPLERS
BALL VALVES
LIVE SWIVEL
ASSEMBLY FABRICATION
ACCESSORIES
EQUIPMENT AND PARTS
KITS
AIR BRAKE HOSE ASSY
BRASS

## Female DIN 24° Cone Swivel - Heavy Series with O-Ring - 90° Bent Tube

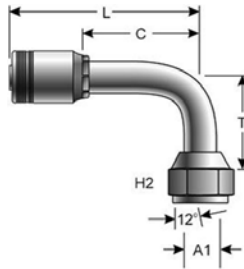

Part No.	Descr.	Prod. No.	⊖		H2	T		L		C		A1	
			"	mm		"	mm	"	mm	"	mm		
G24730-2438	24GSM-38FDHORX90	7341-07075	1 1/2	38.1	M52X2.0	60	3.62	92.0	8.76	222.5	5.02	127.5	38.0

## Male British Standard Pipe Parallel

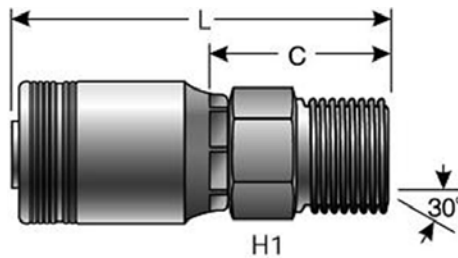

Part No.	Descr.	Prod. No.	⊖		H1	L		C		
			"	mm		"	mm	"	mm	
G24810-2424	24GSM-24MBSPPP	7341-07025	1 1/2	38.1	1 1/2-11	55	6.41	162.8	2.67	67.8
G23810-3232	32GSM-32MBSPPP	7341-20585	2	50.8	2-11	70	7.40	188.0	2.91	74.0

## Female British Standard Parallel Pipe O-Ring Swivel

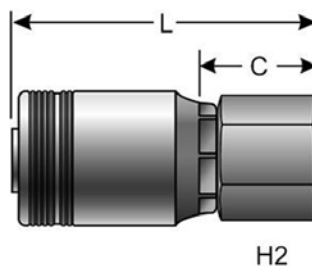

Part No.	Descr.	Prod. No.	⊖		H2	L		C		
			"	mm		"	mm	"	mm	
G24830-2424	24GSM-24FBSPORX	7341-07015	1 1/2	38.1	1 1/2-11	55	6.06	153.9	2.32	58.9
G23830-3232	32GSM-32FBSPORX	7341-20555	2	50.8	2-11	70	7.24	183.9	2.76	70.0



### Female British Standard Parallel Pipe O-Ring Swivel - 45° Bent Tube

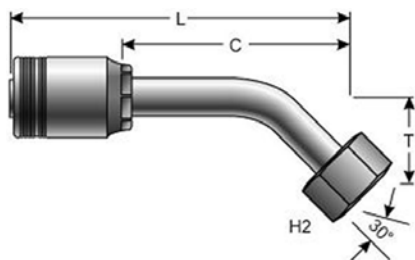

Part No.	Descr.	Prod. No.	⊘		H2		T		L		C	
			"	mm	"	mm	"	mm	"	mm	"	mm
G24831-2424	24GSM-24FBSPORX45	7341-07035	1 1/2	38.1	1 1/2-11	55	1.96	49.8	9.56	242.8	5.81	147.6
G23831-3232	32GSM-32FBSPORX45	7341-20565	2	50.8	2-11	70	2.95	75.0	12.11	307.6	7.62	193.6

### Female British Standard Parallel Pipe O-Ring Swivel - 90° Bent Tube

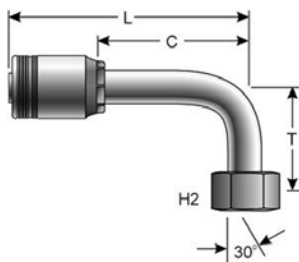

Part No.	Descr.	Prod. No.	⊘		H2		T		L		C	
			"	mm	"	mm	"	mm	"	mm	"	mm
G24832-2424	24GSM-24FBSPORX90	7341-07045	1 1/2	38.1	1 1/2-11	55	3.94	100.1	8.76	222.5	5.02	127.5
G23832-3232	32GSM-32FBSPORX90	7341-20575	2	50.8	2-11	70	5.91	150.1	10.89	276.5	6.40	162.5

### ISO 6164 4-bolt Square Heavy Captive Flange

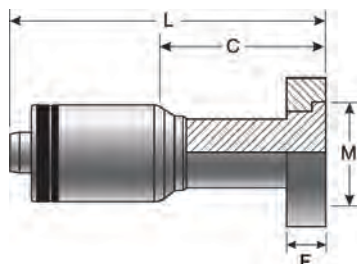

Part No.	Descr.	Prod. No.	⊘		M		L		C		F	
			"	mm	"	mm	"	mm	"	mm	"	mm
G24857-4063	40GSM-63FLSHCF	7341-20665	2 1/2	63.5	5.91	150.0	15.00	380.0	7.95	202.0	2.05	52.0
G24857-4880	48GSM-80FLSHCF	7341-20705	3	76.2	7.09	180.0	17.30	440.0	9.57	243.0	2.76	70.0

EQUIPMENT
HOSE/CPLG. SELECTION
G8K COUPLINGS
GLOBALSPIRAL COUPLINGS
STAINLESS STEEL SPIRAL
MEGACRIMP COUPLINGS
STAINLESS STEEL BRAID
POWER CRIMP COUPLINGS
FIELD ATTACHABLE G1 & G2 COUPLINGS
FIELD ATTACHABLE C5 COUPLINGS
C14 COUPLINGS
GL COUPLINGS
GLX COUPLINGS
PCTS THERMOPLASTIC COUPLINGS
POLARSEAL COUPLINGS (ACA)
POLARSEAL II COUPLINGS (ACC)
POLARSEAL II COUPLINGS (ACB)
POWER STEERING
ADAPTERS
QUICK DISCONNECT COUPLERS
BALL VALVES
LIVE SWIVEL
ASSEMBLY FABRICATION
ACCESSORIES
EQUIPMENT AND PARTS
KITS
AIR BRAKE HOSE ASSY
BRASS



## GSM Butt Weld

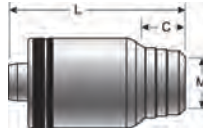

EQUIPMENT
HOSE/CPLG. SELECTION
G8K COUPLINGS
<b>GLOBALSPIRAL COUPLINGS</b>
STAINLESS STEEL SPIRAL
MEGACRIMP COUPLINGS
STAINLESS STEEL BRAID
POWER CRIMP COUPLINGS
FIELD ATTACHABLE G1 & G2 COUPLINGS
FIELD ATTACHABLE C5 COUPLINGS
C14 COUPLINGS
GL COUPLINGS
GLX COUPLINGS
PCTS THERMOPLASTIC COUPLINGS
POLARSEAL COUPLINGS (ACA)
POLARSEAL II COUPLINGS (ACC)
POLARSEAL II COUPLINGS (ACB)
POWER STEERING
ADAPTERS
QUICK DISCONNECT COUPLERS
BALL VALVES
LIVE SWIVEL
ASSEMBLY FABRICATION
ACCESSORIES
EQUIPMENT AND PARTS
KITS
AIR BRAKE HOSE ASSY
BRASS

Part No.	Descr.	Prod. No.	⊖		M		L		C	
			"	mm	"	mm	"	mm	"	mm
G24860-4040	40GSM-40XXSBW	7341-20685	2 1/2	63.5	1.77	45.0	9.65	245.1	2.64	67.1
G24860-4848	48GSM-48XXSBW	7341-20725	3	76.2	2.28	58.0	10.70	272.0	2.95	75.0



## HYDRAULIC HOSE FOR STAINLESS STEEL SPIRAL COUPLINGS



Also available with MegaTuff® cover



Also available with MegaTuff® cover



Also available with MegaTuff® and XtraTuff® cover



Also available with MegaTuff® and XtraTuff® cover



Also available with MegaTuff® and XtraTuff® cover



**The Gates eCrimp program** is a web based utility which allows users and distributors of Gates hydraulic and industrial hose products to find and print the most up to date crimp specifications with nothing more than an internet browser.

This program can be used to find crimp data for all Gates crimpers. Custom result may be printed by selecting the crimper, hose and coupling. Optionally results may also be limited by die set and working pressure.

The eCrimp web application can be directly accessed from a web browser by entering <http://eCrimp.Gates.com> for the website.

**The eCrimp mobile app** is available for download for the iPhone and iPad from the App Store.

EQUIPMENT
HOSE/CPLG. SELECTION
G8K COUPLINGS
GLOBAL SPIRAL COUPLINGS
STAINLESS STEEL SPIRAL
MEGACRIMP COUPLINGS
STAINLESS STEEL BRAID
POWER CRIMP COUPLINGS
FIELD ATTACHABLE G1 & G2 COUPLINGS
FIELD ATTACHABLE C5 COUPLINGS
C14 COUPLINGS
GL COUPLINGS
GLX COUPLINGS
PCTS THERMOPLASTIC COUPLINGS
POLARSEAL COUPLINGS (ACA)
POLARSEAL II COUPLINGS (ACC)
POLARSEAL II COUPLINGS (ACB)
POWER STEERING
ADAPTERS
QUICK DISCONNECT COUPLERS
BALL VALVES
LIVE SWIVEL
ASSEMBLY FABRICATION
ACCESSORIES
EQUIPMENT AND PARTS
KITS
AIR BRAKE HOSE ASSY
BRASS





EQUIPMENT
HOSE/CPLG. SELECTION
G8K COUPLINGS
GLOBAL SPIRAL COUPLINGS
<b>STAINLESS STEEL SPIRAL</b>
MEGACRIMP COUPLINGS
STAINLESS STEEL BRAID
POWER CRIMP COUPLINGS
FIELD ATTACHABLE G1 & G2 COUPLINGS
FIELD ATTACHABLE C5 COUPLINGS
C14 COUPLINGS
GL COUPLINGS
GLX COUPLINGS
PCTS THERMOPLASTIC COUPLINGS
POLARSEAL COUPLINGS (ACA)
POLARSEAL II COUPLINGS (ACC)
POLARSEAL II COUPLINGS (ACB)
POWER STEERING
ADAPTERS
QUICK DISCONNECT COUPLERS
BALL VALVES
LIVE SWIVEL
ASSEMBLY FABRICATION
ACCESSORIES
EQUIPMENT AND PARTS
KITS
AIR BRAKE HOSE ASSY
BRASS

### Male Pipe (NPTF - 30° Cone Seat)

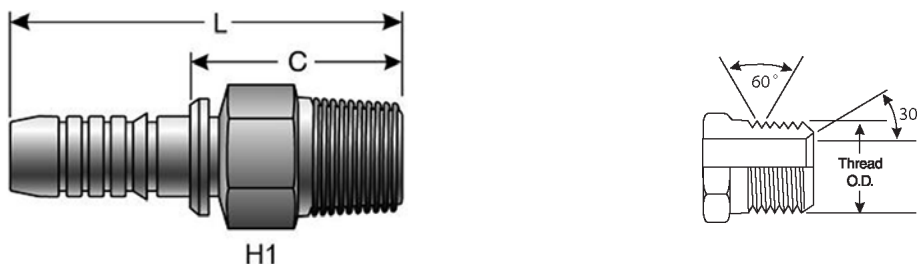

Part No.	Descr.	Prod. No.	⌀		H1	L		C			
			"	mm		"	mm	"	mm		
G18100-0606	6S-6MP-SS	7362-00285	3/8	9.5	3/8-18	.68	17.3	2.24	56.9	1.22	31.0
G18100-0808	8S-8MP-SS	7362-00305	1/2	12.7	1/2-14	.87	22.2	1.22	31.0	1.43	36.3
G18100-1212	12S-12MP-SS	7362-00335	3/4	19.1	3/4-14	1.06	27	3.54	90.0	1.54	39.0
G18100-1616	16S-16MP-SS	7362-00365	1	25.4	1-11 1/2	1.37	34.8	4.17	106.0	1.94	49.2
G18100-2020	20S-20MP-SS	7362-00395	1 1/4	31.8	1 1/4-11 1/2	1.81	46	4.94	125.5	2.19	55.6

### API Line Pipe Connection

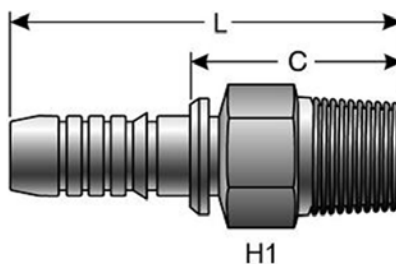

Part No.	Descr.	Prod. No.	⌀		L	C			
			"	mm		"	mm		
G18102-2424	24S-24MPAPI-SS	7362-00455	1 1/2	38.1	1 1/2-11 1/2	6.26	159.0	2.74	69.5

### Female JIC 37° Flare Swivel

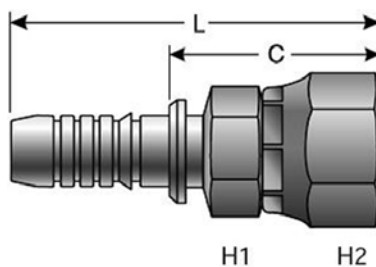

Part No.	Descr.	Prod. No.	⌀		H1	H2		L		C			
			"	mm		"	mm	"	mm	"	mm		
G18170-0606	6S-6FJX-SS	7362-01245	3/8	9.5	9/16-18	.69	17.5	.75	19.1	2.23	56.6	1.21	30.8



Female JIC 37° Flare Swivel - Continued

Part No.	Descr.	Prod. No.	⊘		🌀		H1		H2		L		C	
			"	mm	"	mm	"	mm	"	mm	"	mm	"	mm
G18170-0808	8S-8FJSX-SS	7362-01275	1/2	12.7	3/4-16	.88	22.4	.88	22.4	2.84	72.1	1.36	34.5	
G18170-1010	10S-10FJX-SS	7362-01295	5/8	15.9	7/8-14	.94	23.9	1.06	26.9	3.61	91.6	1.63	41.3	
G18170-1212	12S-12FJX-SS	7362-01325	3/4	19.1	1 1/16-12	1.06	26.9	1.25	31.8	3.91	99.3	1.99	50.6	
G18170-1616	16S-16FJX-SS	7362-01385	1	25.4	1 5/16-12	1.38	35.1	1.50	38.1	4.35	110.4	2.11	53.6	
G18170-2020	20S-20FJX-SS	7362-01415	1 1/4	31.8	1 5/8-12	1.88	47.6	2	50.8	5.11	129.9	2.36	66.0	
G18170-2424	24S-24FJX-SS	7362-01445	1 1/2	38.1	1 7/8-12	2	50.8	2.25	57.2	6.00	152.5	2.48	63.0	
G18170-3232	32S-32FJX-SS	7362-01475	2	50.8	2 1/2-12	2.63	66.7	3	76.2	6.68	169.6	2.85	72.4	

Female Flat-Face O-Ring Swivel Metric Hex

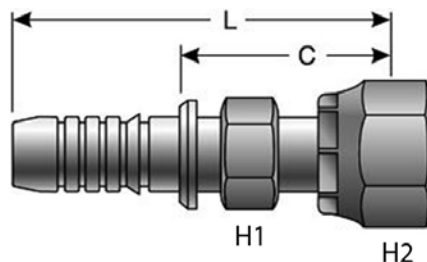

Part No.	Descr.	Prod. No.	⊘		🌀		H1		H2		L		C	
			"	mm	"	mm	"	mm	"	mm	"	mm	"	mm
G18230-0606	6S-6FFORX-SS	7362-03265	3/8	9.5	11/16-16	.75	19	.87	22	2.65	67.5	1.26	32.0	
G18230-0808	8S-8FFORX-SS	7362-03275	1/2	12.7	13/16-16	.91	23	.94	24	2.91	74.0	1.43	36.4	
G18230-1010	10S-10FFORX-SS	7362-03295	5/8	15.9	1-14	1.06	27	1.18	30	3.68	93.5	1.70	43.2	
G18230-1212	12S-12FFORX-SS	7362-03315	3/4	19.1	1 3/16-12	1.18	30	1.41	36	3.70	94.0	1.69	43.0	
G18230-1616	16S-16FFORX-SS	7362-03335	1	25.4	1 7/16-12	1.42	36	1.61	41	4.47	113.5	2.23	113.5	
G18230-2020	20S-20FFORX-SS	7362-03355	1 1/4	31.8	1 11/16-12	1.81	46	1.96	50	5.27	134.0	2.53	64.2	
G18230-2424	24S-24FFORX-SS	7362-03375	1 1/2	38.1	2-12	1.97	50	2.36	60	6.06	154.0	2.54	64.5	

Code 61 O-Ring Flange

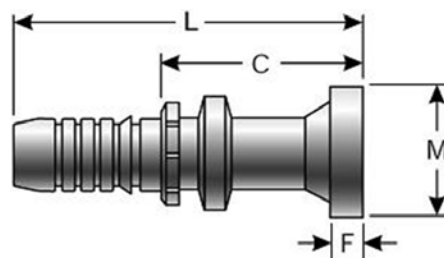

Part No.	Descr.	Prod. No.	⊘		M		L		C		F	
			"	mm	"	mm	"	mm	"	mm	"	mm
G18300-1212	12S-12FL-SS	7362-04375	3/4	19.1	1.50	38.1	4.33	110.0	2.32	59.0	.27	6.9
G18300-1616	16S-16FL-SS	7362-04405	1	25.4	1.75	44.5	4.80	122.0	2.57	65.2	.32	8.1
G18300-2020	20S-20FL-SS	7362-04435	1 1/4	31.8	2.00	50.8	5.43	138.0	2.69	68.2	.32	8.1

EQUIPMENT
HOSE/CPLG. SELECTION
G8K COUPLINGS
GLOBAL SPIRAL COUPLINGS
STAINLESS STEEL SPIRAL
MEGACRIMP COUPLINGS
STAINLESS STEEL BRAID
POWER CRIMP COUPLINGS
FIELD ATTACHABLE G1 & G2 COUPLINGS
FIELD ATTACHABLE C5 COUPLINGS
C14 COUPLINGS
GL COUPLINGS
GLX COUPLINGS
PCTS THERMOPLASTIC COUPLINGS
POLARSEAL COUPLINGS (ACA)
POLARSEAL II COUPLINGS (ACC)
POLARSEAL II COUPLINGS (ACB)
POWER STEERING
ADAPTERS
QUICK DISCONNECT COUPLERS
BALL VALVES
LIVE SWIVEL
ASSEMBLY FABRICATION
ACCESSORIES
EQUIPMENT AND PARTS
KITS
AIR BRAKE HOSE ASSY
BRASS



EQUIPMENT
HOSE/CPLG. SELECTION
G8K COUPLINGS
GLOBAL SPIRAL COUPLINGS
STAINLESS STEEL SPIRAL
MEGACRIMP COUPLINGS
STAINLESS STEEL BRAID
POWER CRIMP COUPLINGS
FIELD ATTACHABLE G1 & G2 COUPLINGS
FIELD ATTACHABLE C5 COUPLINGS
C14 COUPLINGS
GL COUPLINGS
GLX COUPLINGS
PCTS THERMOPLASTIC COUPLINGS
POLARSEAL COUPLINGS (ACA)
POLARSEAL II COUPLINGS (ACC)
POLARSEAL II COUPLINGS (ACB)
POWER STEERING
ADAPTERS
QUICK DISCONNECT COUPLERS
BALL VALVES
LIVE SWIVEL
ASSEMBLY FABRICATION
ACCESSORIES
EQUIPMENT AND PARTS
KITS
AIR BRAKE HOSE ASSY
BRASS

### Code 62 O-Ring Flange Heavy

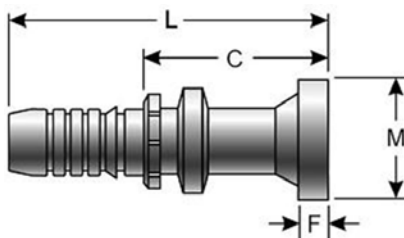

Part No.	Descr.	Prod. No.	⌀		M		L		C		F	
			"	mm	"	mm	"	mm	"	mm	"	mm
G18350-1212	12S-12FLH-SS	7362-04105	3/4	19.1	1.63	41.4	4.48	113.8	2.48	63.0	.35	8.9
G18350-1616	16S-16FLH-SS	7362-04135	1	25.4	1.88	47.8	4.92	125.0	2.68	68.1	.38	9.7
G18350-2020	20S-20FLH-SS	7362-04155	1 1/4	31.8	2.13	54.1	5.75	146.1	3.00	76.2	.41	10.4
G18350-2424	24S-24FLH-SS	7362-04165	1 1/2	38.1	2.50	63.5	7.14	181.6	3.62	92.1	.41	10.4
G18350-3232	32S-32FLH-SS	7362-04195	2	50.8	3.13	79.5	7.24	183.9	3.42	86.9	.50	12.7

### Female DIN 24° Cone Swivel - Heavy Series with O-Ring

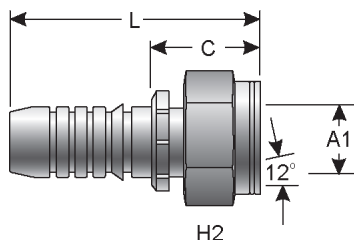

Part No.	Descr.	Prod. No.	⌀		H2	L		C		A1	
			"	mm		"	mm	"	mm	mm	
G18720-1630	16S-30FDHORX-SS	7362-92055	1	25.4	M42X2.0	50	4.33	110.0	2.09	53.1	30.0



Female DIN 24° Cone Swivel - Heavy Series with O-Ring - 90° Bent Tube

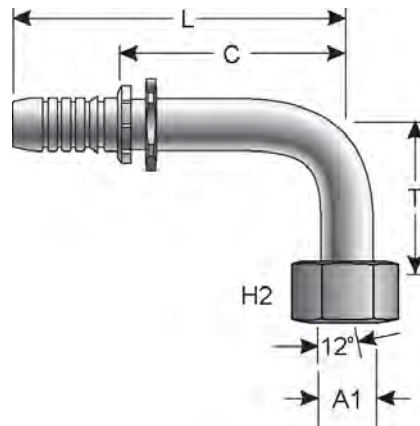

Part No.	Descr.	Prod. No.	⌀		H2	T		L		C		A1	
			"	mm		"	mm	"	mm	"	mm		
G18730-1630	16S-30FDHORX90-SS	7362-93055	1	25.4	M42X2.0	50	2.76	70.0	5.50	139.7	3.26	82.8	30.0

Non-Skive Ferrules

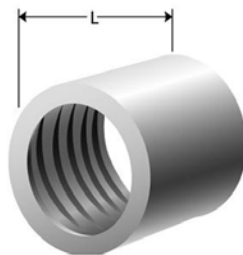

Part No.	Descr.	Prod. No.	⌀		L	
			"	mm	"	mm
G18995-0210	10S1F-2SS	7362-51755	5/8	15.9	1.40	35.6
G18995-0212	12S1F-2SS	7362-51585	3/4	19.1	1.73	44.0
G18995-0216	16S1F-2SS	7362-51595	1	25.4	2.06	52.2
G18995-0406	6S1F-4SS	7362-51445	3/8	9.5	1.10	28.0
G18995-0408	8S1F-4SS	7362-51345	1/2	12.7	1.50	38.1
G18995-0410	10S1F-4SS	7362-51485	5/8	15.9	1.88	47.8
G18995-0412	12S1F-4SS	7362-51495	3/4	19.1	2.00	50.8
G18995-0416	16S1F-4SS	7362-51525	1	25.4	2.22	56.4
G18995-0420	20S1F-4SS	7362-51535	1 1/4	31.8	2.67	67.8
G18995-0620	20S1F-6SS	7362-51625	1 1/4	31.8	2.87	72.9

- EQUIPMENT
- HOSE/CPLG. SELECTION
- G8K COUPLINGS
- GLOBALSPIRAL COUPLINGS
- STAINLESS STEEL SPIRAL
- MEGACRIMP COUPLINGS
- STAINLESS STEEL BRAID
- POWER CRIMP COUPLINGS
- FIELD ATTACHABLE G1 & G2 COUPLINGS
- FIELD ATTACHABLE C5 COUPLINGS
- C14 COUPLINGS
- GL COUPLINGS
- GLX COUPLINGS
- PCTS THERMOPLASTIC COUPLINGS
- POLARSEAL COUPLINGS (ACA)
- POLARSEAL II COUPLINGS (ACC)
- POLARSEAL II COUPLINGS (ACB)
- POWER STEERING
- ADAPTERS
- QUICK DISCONNECT COUPLERS
- BALL VALVES
- LIVE SWIVEL
- ASSEMBLY FABRICATION
- ACCESSORIES
- EQUIPMENT AND PARTS
- KITS
- AIR BRAKE HOSE ASSY
- BRASS



EQUIPMENT
HOSE/CPLG. SELECTION
G8K COUPLINGS
GLOBAL SPIRAL COUPLINGS
STAINLESS STEEL SPIRAL
MEGACRIMP COUPLINGS
STAINLESS STEEL BRAID
POWER CRIMP COUPLINGS
FIELD ATTACHABLE G1 & G2 COUPLINGS
FIELD ATTACHABLE C5 COUPLINGS
C14 COUPLINGS
GL COUPLINGS
GLX COUPLINGS
PCTS THERMOPLASTIC COUPLINGS
POLARSEAL COUPLINGS (ACA)
POLARSEAL II COUPLINGS (ACC)
POLARSEAL II COUPLINGS (ACB)
POWER STEERING
ADAPTERS
QUICK DISCONNECT COUPLERS
BALL VALVES
LIVE SWIVEL
ASSEMBLY FABRICATION
ACCESSORIES
EQUIPMENT AND PARTS
KITS
AIR BRAKE HOSE ASSY
BRASS

## Skive Ferrules

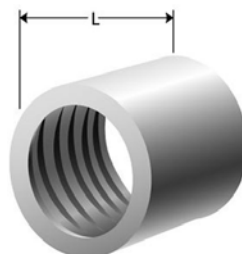

Part No.	Descr.	Prod. No.	⌀		L	
			"	mm	"	mm
G18995-0624	24S2F-6SS	7362-51655	1 1/2	38.1	3.53	89.7
G18995-0632	32S2F-6SS	7362-51685	2	50.8	3.68	93.5



# HYDRAULIC HOSE FOR MEGACRIMP® COUPLINGS

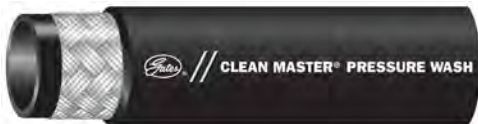

Also available with MegaTuff® cover



EQUIPMENT
HOSE/CPLG. SELECTION
G8K COUPLINGS
GLOBALSPIRAL COUPLINGS
STAINLESS STEEL SPIRAL
<b>MEGACRIMP COUPLINGS</b>
STAINLESS STEEL BRAID
POWER CRIMP COUPLINGS
FIELD ATTACHABLE G1 & G2 COUPLINGS
FIELD ATTACHABLE C5 COUPLINGS
C14 COUPLINGS
GL COUPLINGS
GLX COUPLINGS
PCTS THERMOPLASTIC COUPLINGS
POLARSEAL COUPLINGS (ACA)
POLARSEAL II COUPLINGS (ACC)
POLARSEAL II COUPLINGS (ACB)
POWER STEERING
ADAPTERS
QUICK DISCONNECT COUPLERS
BALL VALVES
LIVE SWIVEL
ASSEMBLY FABRICATION
ACCESSORIES
EQUIPMENT AND PARTS
KITS
AIR BRAKE HOSE ASSY
BRASS





EQUIPMENT
HOSE/CPLG. SELECTION
G8K COUPLINGS
GLOBAL SPIRAL COUPLINGS
STAINLESS STEEL SPIRAL
<b>MEGACRIMP COUPLINGS</b>
STAINLESS STEEL BRAID
POWER CRIMP COUPLINGS
FIELD ATTACHABLE G1 & G2 COUPLINGS
FIELD ATTACHABLE C5 COUPLINGS
C14 COUPLINGS
GL COUPLINGS
GLX COUPLINGS
PCTS THERMOPLASTIC COUPLINGS
POLARSEAL COUPLINGS (ACA)
POLARSEAL II COUPLINGS (ACC)
POLARSEAL II COUPLINGS (ACB)
POWER STEERING
ADAPTERS
QUICK DISCONNECT COUPLERS
BALL VALVES
LIVE SWIVEL
ASSEMBLY FABRICATION
ACCESSORIES
EQUIPMENT AND PARTS
KITS
AIR BRAKE HOSE ASSY
BRASS

## HYDRAULIC HOSE FOR MEGACRIMP® COUPLINGS - CONTINUED



Also available with MegaTuff® cover



Also available with MegaTuff® cover

Also available with MegaTuff® and XtraTuff® cover



Also available with MegaTuff® and XtraTuff® cover



Also available with MegaTuff® and XtraTuff® cover



Also available with MegaTuff® and XtraTuff® cover



Also available with MegaTuff® cover



Also available with MegaTuff® and XtraTuff® cover







# HYDRAULIC HOSE FOR MEGACRIMP® COUPLINGS - CONTINUED



EQUIPMENT
HOSE/CPLG. SELECTION
G8K COUPLINGS
GLOBALSPIRAL COUPLINGS
STAINLESS STEEL SPIRAL
<b>MEGACRIMP COUPLINGS</b>
STAINLESS STEEL BRAID
POWER CRIMP COUPLINGS
FIELD ATTACHABLE G1 & G2 COUPLINGS
FIELD ATTACHABLE C5 COUPLINGS
C14 COUPLINGS
GL COUPLINGS
GLX COUPLINGS
PCTS THERMOPLASTIC COUPLINGS
POLARSEAL COUPLINGS (ACA)
POLARSEAL II COUPLINGS (ACC)
POLARSEAL II COUPLINGS (ACB)
POWER STEERING
ADAPTERS
QUICK DISCONNECT COUPLERS
BALL VALVES
LIVE SWIVEL
ASSEMBLY FABRICATION
ACCESSORIES
EQUIPMENT AND PARTS
KITS
AIR BRAKE HOSE ASSY
BRASS



EQUIPMENT
HOSE/CPLG. SELECTION
G8K COUPLINGS
GLOBAL SPIRAL COUPLINGS
STAINLESS STEEL SPIRAL
MEGACRIMP COUPLINGS
STAINLESS STEEL BRAID
POWER CRIMP COUPLINGS
FIELD ATTACHABLE G1 & G2 COUPLINGS
FIELD ATTACHABLE C5 COUPLINGS
C14 COUPLINGS
GL COUPLINGS
GLX COUPLINGS
PCTS THERMOPLASTIC COUPLINGS
POLARSEAL COUPLINGS (ACA)
POLARSEAL II COUPLINGS (ACC)
POLARSEAL II COUPLINGS (ACB)
POWER STEERING
ADAPTERS
QUICK DISCONNECT COUPLERS
BALL VALVES
LIVE SWIVEL
ASSEMBLY FABRICATION
ACCESSORIES
EQUIPMENT AND PARTS
KITS
AIR BRAKE HOSE ASSY
BRASS

## HYDRAULIC HOSE FOR MEGACRIMP® COUPLINGS - CONTINUED



**The Gates eCrimp program** is a web based utility which allows users and distributors of Gates hydraulic and industrial hose products to find and print the most up to date crimp specifications with nothing more than an internet browser.

This program can be used to find crimp data for all Gates crimpers. Custom result may be printed by selecting the crimper, hose and coupling. Optionally results may also be limited by die set and working pressure.

The eCrimp web application can be directly accessed from a web browser by entering <http://eCrimp.Gates.com> for the website.

**The eCrimp mobile app** is available for download for the iPhone and iPad from the App Store.



### Male Pipe (NPTF - 30° Cone Seat)



Part No.	Descr.	Prod. No.	⊖		H1	L		C		
			"	mm		"	"	mm	"	mm
G25100-0402	4G-2MP	7100-10025	1/4	6.4	1/8-27	1/2	1.96	49.8	.94	23.9
G25100-0404	4G-4MP	7100-10035	1/4	6.4	1/4-18	9/16	2.17	55.0	1.14	29.0
G25100-0406	4G-6MP	7100-10045	1/4	6.4	3/8-18	11/16	2.17	55.0	1.14	29.0
G25100-0408	4G-8MP	7100-10055	1/4	6.4	1/2-14	7/8	2.44	62.0	1.41	35.8
G25100-0504	5G-4MP	7100-00065	5/16	7.9	1/4-18	5/8	2.28	58.0	1.18	30.0
G25100-0506	5G-6MP	7100-10065	5/16	7.9	3/8-18	11/16	2.32	59.0	1.22	31.0
G25100-0604	6G-4MP	7100-10075	3/8	9.5	1/4-18	5/8	2.32	58.9	1.22	31.0
G25100-0606	6G-6MP	7100-10085	3/8	9.5	3/8-18	11/16	2.32	58.9	1.22	31.0
G25100-0608	6G-8MP	7100-10095	3/8	9.5	1/2-14	7/8	2.51	63.8	1.42	36.1
G25100-0804	8G-4MP	7100-10105	1/2	12.7	1/4-18	13/16	2.72	69.0	1.24	31.5
G25100-0806	8G-6MP	7100-00105	1/2	12.7	3/8-18	13/16	2.72	69.0	1.24	31.5
G25100-0808	8G-8MP	7100-00115	1/2	12.7	1/2-14	7/8	2.87	73.0	1.40	35.5
G25100-0812	8G-12MP	7100-00125	1/2	12.7	3/4-14	1 1/16	2.95	74.9	1.47	37.3
G25100-1008	10G-8MP	7100-00225	5/8	15.9	1/2-14	15/16	2.95	75.0	1.48	37.5
G25100-1012	10G-12MP	7100-00235	5/8	15.9	3/4-14	1 1/16	2.95	75.0	1.48	37.5
G25100-1208	12G-8MP	7100-00155	3/4	19.1	1/2-14	1 1/16	3.46	87.9	1.45	36.8
G25100-1212	12G-12MP	7100-00165	3/4	19.1	3/4-14	1 1/16	3.46	87.9	1.45	36.8
G25100-1216	12G-16MP	7100-00175	3/4	19.1	1-11 1/2	1 3/8	3.77	95.8	1.77	45.0
G25100-1612	16G-12MP	7100-00195	1	25.4	3/4-14	1 3/8	3.93	99.8	1.70	43.2
G25100-1616	16G-16MP	7100-00205	1	25.4	1-11 1/2	1 3/8	4.11	104.4	1.87	47.5
G25100-2020	20G-20MP	7100-00215	1 1/4	31.8	1 1/4-11 1/2	1 3/4	4.44	112.8	2.12	53.8

### Male Pipe Long Nose

For use with J2AT Jack Hose and special high-pressure applications.

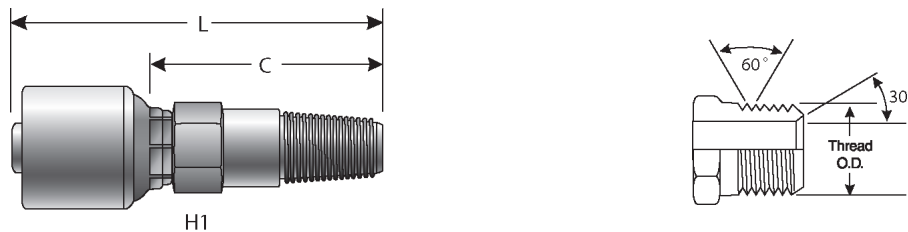

Part No.	Descr.	Prod. No.	⊖		H1	L		C		
			"	mm		"	"	mm	"	mm
G25101-0404	4G-4MPLN	7100-16615	1/4	6.4	1/4-18	9/16	2.56	65.0	1.54	39.0
G25101-0406	4G-6MPLN	7100-16625	1/4	6.4	3/8-18	11/16	2.56	65.0	1.54	39.0
G25101-0604	6G-4MPLN	7100-16645	3/8	9.5	1/4-18	5/8	2.72	69.0	1.62	41.1
G25101-0606	6G-6MPLN	7100-16635	3/8	9.5	3/8-18	11/16	2.72	69.0	1.62	41.1

- EQUIPMENT
- HOSE/CPLG. SELECTION
- G8K COUPLINGS
- GLOBALSPIRAL COUPLINGS
- STAINLESS STEEL SPIRAL
- MEGACRIMP COUPLINGS**
- STAINLESS STEEL BRAID
- POWER CRIMP COUPLINGS
- FIELD ATTACHABLE G1 & G2 COUPLINGS
- FIELD ATTACHABLE C5 COUPLINGS
- C14 COUPLINGS
- GL COUPLINGS
- GLX COUPLINGS
- PCTS THERMOPLASTIC COUPLINGS
- POLARSEAL COUPLINGS (ACA)
- POLARSEAL II COUPLINGS (ACC)
- POLARSEAL II COUPLINGS (ACB)
- POWER STEERING
- ADAPTERS
- QUICK DISCONNECT COUPLERS
- BALL VALVES
- LIVE SWIVEL
- ASSEMBLY FABRICATION
- ACCESSORIES
- EQUIPMENT AND PARTS
- KITS
- AIR BRAKE HOSE ASSY
- BRASS



EQUIPMENT
HOSE/CPLG. SELECTION
G8K COUPLINGS
GLOBAL SPIRAL COUPLINGS
STAINLESS STEEL SPIRAL
MEGACRIMP COUPLINGS
STAINLESS STEEL BRAID
POWER CRIMP COUPLINGS
FIELD ATTACHABLE G1 & G2 COUPLINGS
FIELD ATTACHABLE C5 COUPLINGS
C14 COUPLINGS
GL COUPLINGS
GLX COUPLINGS
PCTS THERMOPLASTIC COUPLINGS
POLARSEAL COUPLINGS (ACA)
POLARSEAL II COUPLINGS (ACC)
POLARSEAL II COUPLINGS (ACB)
POWER STEERING
ADAPTERS
QUICK DISCONNECT COUPLERS
BALL VALVES
LIVE SWIVEL
ASSEMBLY FABRICATION
ACCESSORIES
EQUIPMENT AND PARTS
KITS
AIR BRAKE HOSE ASSY
BRASS

### Male Pipe Swivel (NPTF - without 30° Cone Seat)

NOT TO BE USED AS A LIVE SWIVEL.

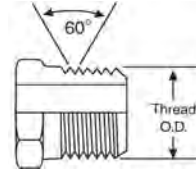
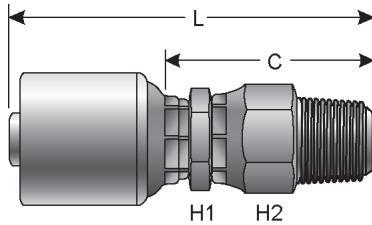

Part No.	Descr.	Prod. No.	⊖		⌀	H1	H2	L		C	
			"	mm				"	mm	"	mm
G25105-0402	4G-2MPX	7100-10245	1/4	6.4	1/8-27	1/2	1/2	2.39	60.7	1.37	34.8
G25105-0404	4G-4MPX	7100-10255	1/4	6.4	1/4-18	1/2	11/16	2.61	66.3	1.58	40.1
G25105-0406	4G-6MPX	7100-10265	1/4	6.4	3/8-18	5/8	7/8	2.73	69.3	1.71	43.4
G25105-0408	4G-8MPX	7100-10275	1/4	6.4	1/2-14	3/4	1	2.97	75.4	1.94	49.4
G25105-0604	6G-4MPX	7100-10285	3/8	9.5	1/4-18	5/8	7/8	2.87	72.8	1.77	44.9
G25105-0606	6G-6MPX	7100-10295	3/8	9.5	3/8-18	5/8	7/8	2.81	71.4	1.71	43.4
G25105-0608	6G-8MPX	7100-10305	3/8	9.5	1/2-14	3/4	1	3.04	77.2	1.94	49.3
G25105-0806	8G-6MPX	7100-00315	1/2	12.7	3/8-18	13/16	7/8	3.22	81.8	1.75	44.5
G25105-0808	8G-8MPX	7100-00325	1/2	12.7	1/2-14	13/16	1	3.42	86.9	1.94	49.3
G25105-1012	10G-12MPX	7100-00335	5/8	15.9	3/4-14	1 1/16	1 5/16	3.48	88.4	2.01	51.1
G25105-1208	12G-8MPX	7100-00345	3/4	19.1	1/2-14	1 1/16	1	3.97	100.8	1.96	49.8
G25105-1212	12G-12MPX	7100-00355	3/4	19.1	3/4-14	1 1/16	1 5/16	4.01	101.9	2.00	50.8
G25105-1616	16G-16MPX	7100-00365	1	25.4	1-11 1/2	1 3/8	1 5/8	4.73	120.1	2.49	63.2

### Male Pipe Swivel - 90° Block (NPTF - without 30° Cone Seat)

NOT TO BE USED AS A LIVE SWIVEL.

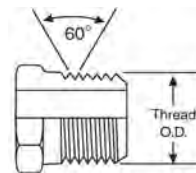
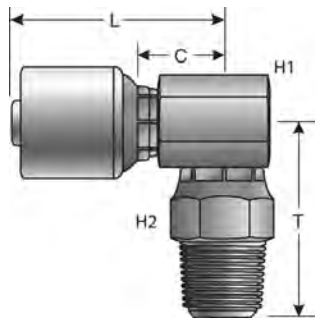

Part No.	Descr.	Prod. No.	⊖		⌀	H1	H2	T		L		C	
			"	mm				"	mm	"	mm	"	mm
G25106-0402	4G-2MPX90	7100-10365	1/4	6.4	1/8-27	11/16	1/2	1.20	30.5	1.75	44.5	.72	18.3
G25106-0404	4G-4MPX90	7100-10375	1/4	6.4	1/4-18	11/16	11/16	1.62	41.1	1.75	44.5	.72	18.3
G25106-0406	4G-6MPX90	7100-10385	1/4	6.4	3/8-18	11/16	7/8	1.73	43.9	1.82	46.2	.79	20.1
G25106-0604	6G-4MPX90	7100-10395	3/8	9.5	1/4-18	3/4	11/16	1.65	41.9	1.96	49.7	.85	21.6
G25106-0606	6G-6MPX90	7100-10405	3/8	9.5	3/8-18	3/4	7/8	1.76	44.7	1.96	49.7	.85	21.6
G25106-0608	6G-8MPX90	7100-10415	3/8	9.5	1/2-14	3/4	1	1.93	49.1	1.96	49.7	.85	21.6
G25106-0806	8G-6MPX90	7100-07135	1/2	12.7	3/8-18	—	7/8	1.88	47.8	2.55	64.7	1.07	27.2
G25106-0808	8G-8MPX90	7100-00425	1/2	12.7	1/2-14	—	1	2.05	52.1	2.55	64.7	1.07	27.2
G25106-1212	12G-12MPX90	7100-00435	3/4	19.1	3/4-14	—	1 5/16	2.30	58.4	3.17	80.5	1.16	29.5



## Male Pipe Swivel - 90° Long Block (NPTF - without 30° Cone Seat)

NOT TO BE USED AS A LIVE SWIVEL.

These couplings have a longer reach (L dimension) to accommodate the OmniCrimp 21 crimper.

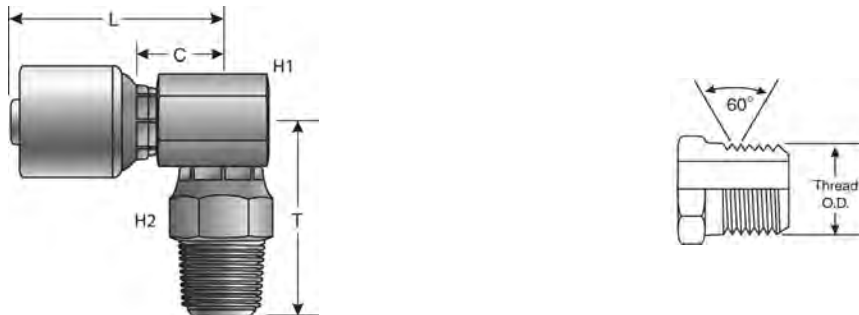

Part No.	Descr.	Prod. No.	⊖		1/2-14	H1	H2	T		L		C	
			"	mm				"	mm	"	mm	"	mm
G25107-0608	6G-8MPX90L	7100-00445	3/8	9.5	1/2-14	3/4	1	1.93	49.0	3.40	86.4	1.94	49.3
G25107-0808	8G-8MPX90L	7100-00455	1/2	12.7	1/2-14	1	1	2.06	52.3	3.27	83.1	1.80	45.7
G25107-1212	12G-12MPX90L	7100-00475	3/4	19.1	3/4-14	1 3/8	1 5/16	2.30	58.4	3.93	99.7	1.92	48.7

## Female Pipe (NPTF - without 30° Cone Seat)



Part No.	Descr.	Prod. No.	⊖		1/8-27	H1	L		C	
			"	mm			"	mm	"	mm
G25110-0402	4G-2FP	7100-10485	1/4	6.4	1/8-27	9/16	1.74	44.2	.72	18.3
G25110-0404	4G-4FP	7100-10495	1/4	6.4	1/4-18	11/16	1.98	50.3	.96	24.4
G25110-0406	4G-6FP	7100-10505	1/4	6.4	3/8-18	13/16	1.98	50.3	.96	24.4
G25110-0604	6G-4FP	7100-10515	3/8	9.5	1/4-18	11/16	2.00	50.8	.90	22.9
G25110-0606	6G-6FP	7100-10525	3/8	9.5	3/8-18	13/16	2.06	52.3	.96	24.4
G25110-0608	6G-8FP	7100-10535	3/8	9.5	1/2-14	1	2.24	56.9	1.14	29.0
G25110-0806	8G-6FP	7100-00545	1/2	12.7	3/8-18	13/16	2.46	62.5	.98	24.9
G25110-0808	8G-8FP	7100-00555	1/2	12.7	1/2-14	1	2.63	66.8	1.16	29.5
G25110-1212	12G-12FP	7100-00565	3/4	19.1	3/4-14	1 1/4	3.22	81.8	1.22	31.0

EQUIPMENT
HOSE/CPLG. SELECTION
G8K COUPLINGS
GLOBALSPIRAL COUPLINGS
STAINLESS STEEL SPIRAL
MEGACRIMP COUPLINGS
STAINLESS STEEL BRAID
POWER CRIMP COUPLINGS
FIELD ATTACHABLE G1 & G2 COUPLINGS
FIELD ATTACHABLE C5 COUPLINGS
C14 COUPLINGS
GL COUPLINGS
GLX COUPLINGS
PCTS THERMOPLASTIC COUPLINGS
POLARSEAL COUPLINGS (ACA)
POLARSEAL II COUPLINGS (ACC)
POLARSEAL II COUPLINGS (ACB)
POWER STEERING
ADAPTERS
QUICK DISCONNECT COUPLERS
BALL VALVES
LIVE SWIVEL
ASSEMBLY FABRICATION
ACCESSORIES
EQUIPMENT AND PARTS
KITS
AIR BRAKE HOSE ASSY
BRASS





EQUIPMENT
HOSE/CPLG. SELECTION
G8K COUPLINGS
GLOBAL SPIRAL COUPLINGS
STAINLESS STEEL SPIRAL
MEGACRIMP COUPLINGS
STAINLESS STEEL BRAID
POWER CRIMP COUPLINGS
FIELD ATTACHABLE G1 & G2 COUPLINGS
FIELD ATTACHABLE C5 COUPLINGS
C14 COUPLINGS
GL COUPLINGS
GLX COUPLINGS
PCTS THERMOPLASTIC COUPLINGS
POLARSEAL COUPLINGS (ACA)
POLARSEAL II COUPLINGS (ACC)
POLARSEAL II COUPLINGS (ACB)
POWER STEERING
ADAPTERS
QUICK DISCONNECT COUPLERS
BALL VALVES
LIVE SWIVEL
ASSEMBLY FABRICATION
ACCESSORIES
EQUIPMENT AND PARTS
KITS
AIR BRAKE HOSE ASSY
BRASS

## Female Pipe Swivel (NPSM - 30° Cone Seat)



Part No.	Descr.	Prod. No.	⊖		🌀	H1		H2		L		C	
			"	mm		"	mm	"	mm	"	mm	"	mm
G25111-0404	4G-4FPX	7100-10575	1/4	6.4	1/4-18	1/2	—	11/16	2.24	56.9	1.21	30.7	
G25111-0606	6G-6FPX	7100-10585	3/8	9.5	3/8-18	5/8	—	7/8	2.48	63.0	1.38	35.1	
G25111-0608	6G-8FPX	7100-10595	3/8	9.5	1/2-14	13/16	—	1	2.55	64.8	1.45	36.8	
G25111-0808	8G-8FPX	7100-00595	1/2	12.7	1/2-14	13/16	—	1	2.88	73.2	1.41	35.8	
G25111-1212	12G-12FPX	7100-00605	3/4	19.1	3/4-14	—	27	1 1/4	3.71	94.2	1.70	43.2	
G25111-1616	16G-16FPX	7100-00615	1	25.4	1-11 1/2	1 3/8	—	1 1/2	4.10	104.1	1.87	47.5	
G25111-2020	20G-20FPX	7100-00625	1 1/4	31.8	1 1/4-11 1/2	1 3/4	—	1 7/8	4.67	118.6	2.26	57.4	

## Male O-Ring Boss

SAE J1926/3 ISO 11926-3 Light-Duty (L Series) Stud End.



Part No.	Descr.	Prod. No.	⊖		🌀	H1	L		C	
			"	mm			"	mm	"	mm
G25120-0404	4G-4MB	7100-12205	1/4	6.4	7/16-20	9/16	1.99	50.5	.96	24.5
G25120-0405	4G-5MB	7100-12215	1/4	6.4	1/2-20	5/8	1.99	50.5	.96	24.5
G25120-0406	4G-6MB	7100-12225	1/4	6.4	9/16-18	11/16	2.05	52.0	1.02	26.0
G25120-0605	6G-5MB	7100-12285	3/8	9.5	1/2-20	5/8	2.05	52.0	.95	24.1
G25120-0606	6G-6MB	7100-13235	3/8	9.5	9/16-18	11/16	2.20	56.0	1.11	28.1
G25120-0608	6G-8MB	7100-13245	3/8	9.5	3/4-16	7/8	2.28	58.0	1.19	30.1
G25120-0610	6G-10MB	7100-12255	3/8	9.5	7/8-14	1	2.22	56.5	1.13	28.6
G25120-0612	6G-12MB	7100-12265	3/8	9.5	1 1/16-12	1 1/4	2.42	61.5	1.32	33.6
G25120-0808	8G-8MB	7100-13275	1/2	12.7	3/4-16	7/8	2.64	67.0	1.16	29.5
G25120-0810	8G-10MB	7100-13285	1/2	12.7	7/8-14	1	2.68	68.0	1.20	30.5
G25120-0812	8G-12MB	7100-13295	1/2	12.7	1 1/16-12	1 1/4	2.91	74.0	1.44	36.5
G25120-1008	10G-8MB	7100-02305	5/8	15.9	3/4-16	15/16	2.83	72.0	1.36	34.5
G25120-1010	10G-10MB	7100-13315	5/8	15.9	7/8-14	1	2.83	72.0	1.36	34.5
G25120-1012	10G-12MB	7100-13325	5/8	15.9	1 1/16-12	1 1/4	2.99	76.0	1.52	38.5
G25120-1210	12G-10MB	7100-02265	3/4	19.1	7/8-14	1	3.23	82.1	1.22	31.1
G25120-1212	12G-12MB	7100-02335	3/4	19.1	1 1/16-12	1 1/4	3.33	84.5	1.32	33.5
G25120-1214	12G-14MB	7100-02345	3/4	19.1	1 3/16-12	1 3/8	3.31	84.0	1.30	33.0
G25120-1216	12G-16MB	7100-02355	3/4	19.1	1 5/16-12	1 1/2	3.44	87.5	1.44	36.5
G25120-1614	16G-14MB	7100-02365	1	25.4	1 3/16-12	1 3/8	3.78	96.0	1.54	39.2
G25120-1616	16G-16MB	7100-02375	1	25.4	1 5/16-12	1 1/2	3.84	97.5	1.60	40.7
G25120-1620	16G-20MB	7100-02255	1	25.4	1 5/8-12	1 7/8	3.74	95.0	1.50	38.2



Male O-Ring Boss - Continued

Part No.	Descr.	Prod. No.	⊖		H1	L		C		
			"	mm		"	mm	"	mm	
G25120-2020	20G-20MB	7100-02385	1 1/4	31.8	1 5/8-12	1 7/8	3.90	99.0	1.57	40.0

Male O-Ring Boss Swivel

NOT TO BE USED AS A LIVE SWIVEL.  
 NOTE: Internal O-Rings rated at +250°F (+121°C).  
 SAE J1926/3 ISO 11926-3 Light-Duty (L Series) Stud End.

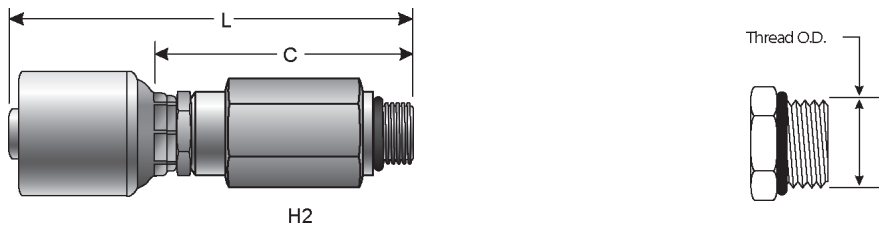

Part No.	Descr.	Prod. No.	⊖		H2	L		C		
			"	mm		"	mm	"	mm	
G25121-0404	4G-4MBX	7209-40015	1/4	6.4	7/16-20	19	3.21	81.5	2.19	55.5
G25121-0406	4G-6MBX	7209-40025	1/4	6.4	9/16-18	19	3.21	81.5	2.19	55.5
G25121-0606	6G-6MBX	7209-40045	3/8	9.5	9/16-18	22	3.33	84.5	2.23	56.6
G25121-0608	6G-8MBX	7209-40055	3/8	9.5	3/4-16	23	3.33	84.5	2.23	56.6
G25121-0610	6G-10MBX	7209-40065	3/8	9.5	7/8-14	27	3.21	81.5	2.11	53.6
G25121-0808	8G-8MBX	7209-40085	1/2	12.7	3/4-16	23	3.78	96.0	2.30	58.5
G25121-0810	8G-10MBX	7209-40095	1/2	12.7	7/8-14	27	3.84	97.5	2.36	60.0
G25121-1010	10G-10MBX	7209-40115	5/8	15.9	7/8-14	32	3.88	98.5	2.40	61.0
G25121-1212	12G-12MBX	7209-40145	3/4	19.1	1 1/16-12	32	4.55	115.5	2.54	64.5

Male O-Ring Boss Swivel - 45° Block

NOT TO BE USED AS A LIVE SWIVEL.  
 NOTE: Internal O-Rings rated at +250°F (+121°C).  
 SAE J1926/3 ISO 11926-3 Light-Duty (L Series) Stud End.

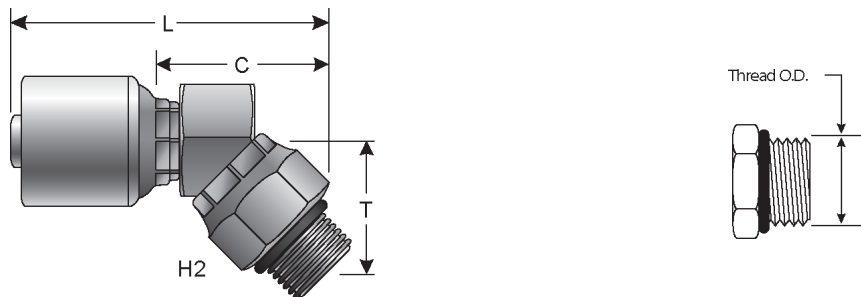

Part No.	Descr.	Prod. No.	⊖		H2	T		L		C		
			"	mm		"	mm	"	mm	"	mm	
G25122-0606	6G-6MBX45BL	7100-12475	3/8	9.5	9/16-18	7/8	1.09	27.8	3.11	79.0	2.01	51.0
G25122-0608	6G-8MBX45BL	7100-12485	3/8	9.5	3/4-16	1	1.06	26.9	3.07	78.1	1.98	50.2
G25122-0808	8G-8MBX45BL	7100-02495	1/2	12.7	3/4-16	1	1.12	28.4	3.04	77.2	1.56	39.7

- EQUIPMENT
- HOSE/CPLG. SELECTION
- G8K COUPLINGS
- GLOBAL SPIRAL COUPLINGS
- STAINLESS STEEL SPIRAL
- MEGACRIMP COUPLINGS
- STAINLESS STEEL BRAID
- POWER CRIMP COUPLINGS
- FIELD ATTACHABLE G1 & G2 COUPLINGS
- FIELD ATTACHABLE C5 COUPLINGS
- C14 COUPLINGS
- GL COUPLINGS
- GLX COUPLINGS
- PCTS THERMOPLASTIC COUPLINGS
- POLARSEAL COUPLINGS (ACA)
- POLARSEAL II COUPLINGS (ACC)
- POLARSEAL II COUPLINGS (ACB)
- POWER STEERING
- ADAPTERS
- QUICK DISCONNECT COUPLERS
- BALL VALVES
- LIVE SWIVEL
- ASSEMBLY FABRICATION
- ACCESSORIES
- EQUIPMENT AND PARTS
- KITS
- AIR BRAKE HOSE ASSY
- BRASS





EQUIPMENT
HOSE/CPLG. SELECTION
G8K COUPLINGS
GLOBAL SPIRAL COUPLINGS
STAINLESS STEEL SPIRAL
<b>MEGACRIMP COUPLINGS</b>
STAINLESS STEEL BRAID
POWER CRIMP COUPLINGS
FIELD ATTACHABLE G1 & G2 COUPLINGS
FIELD ATTACHABLE C5 COUPLINGS
C14 COUPLINGS
GL COUPLINGS
GLX COUPLINGS
PCTS THERMOPLASTIC COUPLINGS
POLARSEAL COUPLINGS (ACA)
POLARSEAL II COUPLINGS (ACC)
POLARSEAL II COUPLINGS (ACB)
POWER STEERING
ADAPTERS
QUICK DISCONNECT COUPLERS
BALL VALVES
LIVE SWIVEL
ASSEMBLY FABRICATION
ACCESSORIES
EQUIPMENT AND PARTS
KITS
AIR BRAKE HOSE ASSY
BRASS

### Male O-Ring Boss Swivel - 45° Block - Continued

Part No.	Descr.	Prod. No.	⊖		H2	T		L		C		
			"	mm		"	mm	"	mm	"	mm	
G25122-0810	8G-10MBX45BL	7100-02505	1/2	12.7	7/8-14	1	1.16	29.5	3.08	78.3	1.61	40.8

### Male O-Ring Boss Swivel - 90° Block

NOT TO BE USED AS A LIVE SWIVEL.  
 NOTE: Internal O-Rings rated at +250°F (+121°C).  
 SAE J1926/3 ISO 11926-3 Light-Duty (L Series) Stud End.

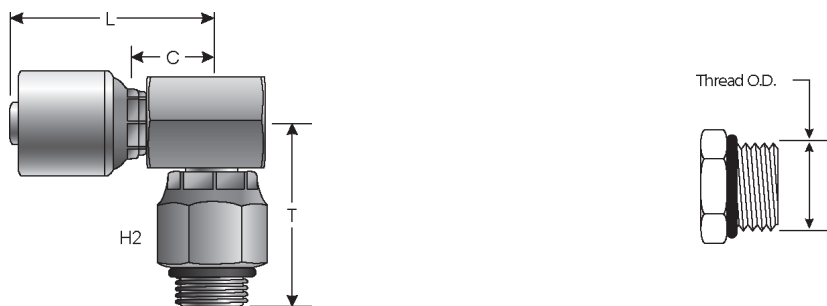

Part No.	Descr.	Prod. No.	⊖		H2	T		L		C		
			"	mm		"	mm	"	mm	"	mm	
G25123-0405	4G-5MBX90BL	7100-12555	1/4	6.4	1/2-20	11/16	1.57	40.0	1.75	44.5	.80	20.2
G25123-0406	4G-6MBX90BL	7100-12515	1/4	6.4	9/16-18	7/8	1.65	41.8	1.82	46.2	.80	20.2
G25123-0606	6G-6MBX90BL	7100-12525	3/8	9.5	9/16-18	7/8	1.67	42.5	2.41	61.2	.86	21.8
G25123-0608	6G-8MBX90BL	7100-12535	3/8	9.5	3/4-16	1	1.63	41.3	2.41	61.2	.86	21.8
G25123-0610	6G-10MBX90BL	7100-12545	3/8	9.5	7/8-14	1	1.69	42.8	1.95	49.6	.85	21.7
G25123-0808	8G-8MBX90BL	7100-02555	1/2	12.7	3/4-16	1	1.75	44.5	2.55	64.8	1.07	27.2
G25124-0808	8G-8MBX90BLL	7100-02705	1/2	12.7	3/4-16	1	1.75	44.4	3.27	83.1	1.80	45.6
G25123-0810	8G-10MBX90BL	7100-02565	1/2	12.7	7/8-14	1	1.81	46.0	2.55	64.7	1.07	27.2
G25124-0810	8G-10MBX90BLL	7100-02715	1/2	12.7	7/8-14	1	1.81	46.0	3.27	83.1	1.80	45.6
G25123-0812	8G-12MBX90BL	7100-02575	1/2	12.7	1 1/16-12	1 5/16	2.09	53.1	2.52	64.1	1.07	27.2
G25124-0812	8G-12MBX90BLL	7100-02725	1/2	12.7	1 1/16-12	1 5/16	2.09	53.1	3.76	95.5	2.28	58.0
G25123-1010	10G-10MBX90BL	7100-02585	5/8	15.9	7/8-14	1	1.81	46.0	2.40	61.0	.93	23.6
G25124-1010	10G-10MBX90BLL	7100-02735	5/8	15.9	7/8-14	1	1.81	46.0	3.15	79.9	1.67	42.4
G25123-1212	12G-12MBX90BL	7100-02595	3/4	19.1	1 1/16-12	1 5/16	2.39	60.7	3.18	80.8	1.17	29.7
G25124-1212	12G-12MBX90BLL	7100-02755	3/4	19.1	1 1/16-12	1 5/16	2.28	57.9	3.94	100.0	1.93	49.0



### Male O-Ring Boss Swivel - 45° Bent Tube

NOT TO BE USED AS A LIVE SWIVEL.  
 NOTE: Internal O-Rings rated at +250°F (+121°C).  
 SAE J1926/3 ISO 11926-3 Light-Duty (L Series) Stud End.

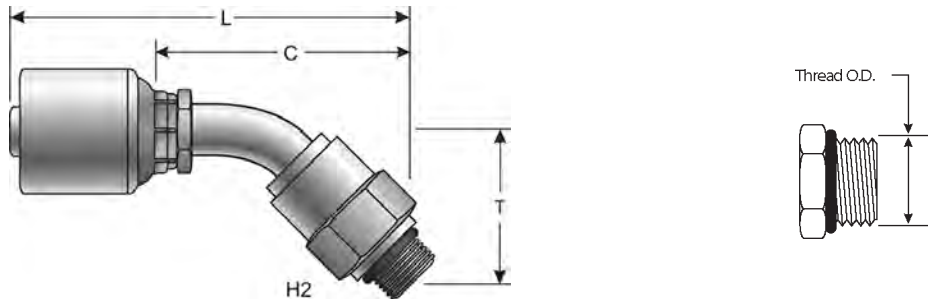

Part No.	Descr.	Prod. No.	⊖			H2	T		L		C	
			"	mm	"	mm	"	mm	"	mm	"	mm
G25126-0606	6G-6MBX45	7209-40225	3/8	9.5	9/16-18	22	1.52	38.7	3.65	92.6	2.54	64.6
G25126-0608	6G-8MBX45	7209-40235	3/8	9.5	3/4-16	24	1.52	38.7	3.65	92.6	2.54	64.6
G25126-0808	8G-8MBX45	7209-40255	1/2	12.7	3/4-16	24	1.64	41.7	4.24	107.7	2.77	70.3
G25126-0810	8G-10MBX45	7209-40265	1/2	12.7	7/8-14	27	1.69	42.8	4.28	108.8	2.81	71.3

### Male O-Ring Boss Swivel - 90° Bent Tube

NOT TO BE USED AS A LIVE SWIVEL.  
 NOTE: Internal O-Rings rated at +250°F (+121°C).  
 SAE J1926/3 ISO 11926-3 Light-Duty (L Series) Stud End.

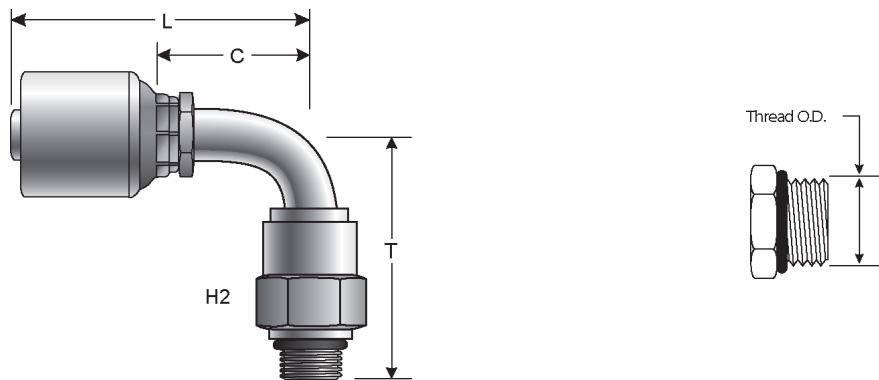

Part No.	Descr.	Prod. No.	⊖			H2	T		L		C	
			"	mm	"	"	"	mm	"	mm	"	mm
G25128-0406	4G-6MBX90	7209-40425	1/4	6.4	9/16-18	7/8	2.36	60.0	2.19	55.6	1.17	29.6
G25128-0606	6G-6MBX90	7209-40455	3/8	9.5	9/16-18	7/8	2.48	63.1	2.47	62.8	1.37	34.8
G25128-0608	6G-8MBX90	7209-40475	3/8	9.5	3/4-16	1	2.48	63.1	2.47	62.8	1.37	34.8
G25128-0610	6G-10MBX90	7209-40485	3/8	9.5	7/8-14	1	2.37	60.1	2.47	62.8	1.37	34.8
G25128-0808	8G-8MBX90	7209-40505	1/2	12.7	3/4-16	1	2.76	70.1	3.16	80.3	1.69	42.9
G25128-0810	8G-10MBX90	7209-40525	1/2	12.7	7/8-14	1	2.82	71.6	3.16	80.3	1.69	42.9
G25128-0812	8G-12MBX90	7209-40545	1/2	12.7	1 1/16-12	1 1/4	2.90	73.6	3.16	80.3	1.69	42.9
G25128-1010	10G-10MBX90	7209-40585	5/8	15.9	7/8-14	1 5/16	3.14	79.8	3.55	90.1	2.07	52.6
G25128-1012	10G-12MBX90	7209-40605	5/8	15.9	1 1/16-12	1	3.18	80.8	3.55	90.1	2.07	52.6
G25128-1212	12G-12MBX90	7209-40645	3/4	19.1	1 1/16-12	1 5/16	3.42	86.8	4.33	110.1	2.33	59.1

EQUIPMENT
HOSE/CPLG. SELECTION
G8K COUPLINGS
GLOBALSPIRAL COUPLINGS
STAINLESS STEEL SPIRAL
<b>MEGACRIMP COUPLINGS</b>
STAINLESS STEEL BRAID
POWER CRIMP COUPLINGS
FIELD ATTACHABLE G1 & G2 COUPLINGS
FIELD ATTACHABLE C5 COUPLINGS
C14 COUPLINGS
GL COUPLINGS
GLX COUPLINGS
PCTS THERMOPLASTIC COUPLINGS
POLARSEAL COUPLINGS (ACA)
POLARSEAL II COUPLINGS (ACC)
POLARSEAL II COUPLINGS (ACB)
POWER STEERING
ADAPTERS
QUICK DISCONNECT COUPLERS
BALL VALVES
LIVE SWIVEL
ASSEMBLY FABRICATION
ACCESSORIES
EQUIPMENT AND PARTS
KITS
AIR BRAKE HOSE ASSY
BRASS



## Male O-Ring Boss Adapterless Swivel - 90° Bent Tube

NOTE: Internal O-Rings rated at +250°F (+121°C).

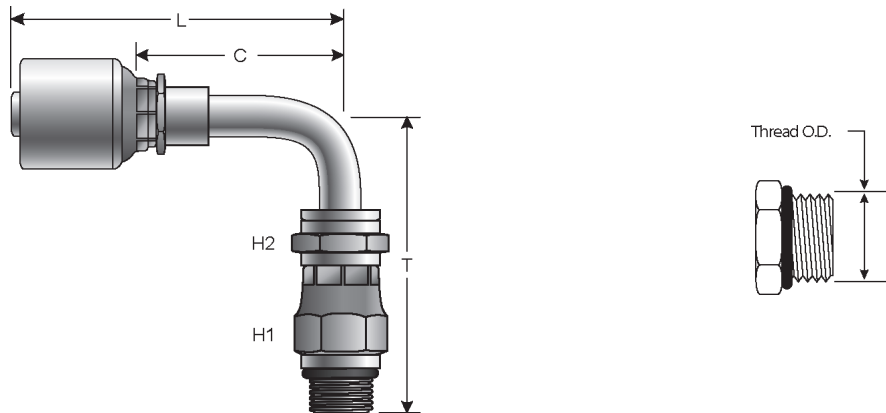

Part No.	Descr.	Prod. No.	⊖		H1	H2	T		L		C		
			"	mm			"	mm	"	mm	"	mm	"
G25134-0404	4G-4MBAX90M	7100-18615	1/4	6.4	7/16-20	17	17	2.95	74.9	2.42	61.5	1.38	35.1
G25134-0606	6G-6MBAX90M	7100-18715	3/8	9.5	9/16-18	22	22	3.27	83.1	2.76	70.1	1.66	42.2
G25134-0808	8G-8MBAX90M	7100-18765	1/2	12.7	3/4-16	24	24	3.82	97.0	3.44	87.4	1.97	50.0
G25134-1010	10G-10MBAX90M	7100-18815	5/8	15.9	7/8-14	30	30	4.33	110.0	3.76	95.5	2.28	57.9
G25134-1212	12G-12MBAX90M	7100-18865	3/4	19.1	1 1/16-12	36	36	4.80	122.0	4.49	114.1	2.48	63.0

## Male JIC 37° Flare

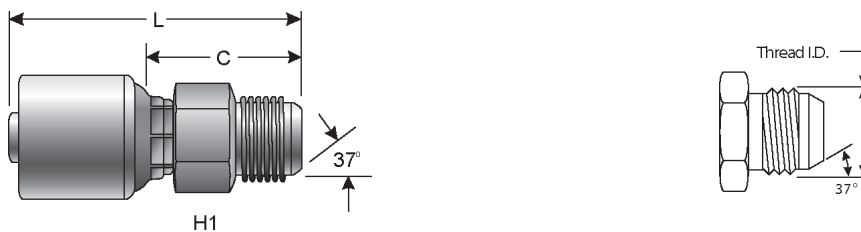

Part No.	Descr.	Prod. No.	⊖		H1	L		C		
			"	mm		"	mm	"	mm	
G25165-0404	4G-4MJ	7103-36045	1/4	6.4	7/16-20	14	2.19	55.5	1.16	29.5
G25165-0405	4G-5MJ	7103-36055	1/4	6.4	1/2-20	14	2.19	55.5	1.16	29.5
G25165-0406	4G-6MJ	7103-36065	1/4	6.4	9/16-18	17	2.22	56.5	1.20	30.5
G25165-0505	5G-5MJ	7103-36105	5/16	7.9	1/2-20	17	2.26	57.5	1.16	29.5
G25165-0506	5G-6MJ	7103-36115	5/16	7.9	9/16-18	17	2.26	57.5	1.16	29.5
G25165-0606	6G-6MJ	7103-36155	3/8	9.5	9/16-18	17	2.30	58.5	1.20	30.6
G25165-0608	6G-8MJ	7103-36165	3/8	9.5	3/4-16	19	2.48	63.0	1.38	35.1
G25165-0610	6G-10MJ	7103-36175	3/8	9.5	7/8-14	24	2.64	67.0	1.54	39.1
G25165-0808	8G-8MJ	7103-36215	1/2	12.7	3/4-16	22	2.81	71.5	1.34	34.0
G25165-0810	8G-10MJ	7103-36225	1/2	12.7	7/8-14	24	2.91	74.0	1.44	36.5
G25165-0812	8G-12MJ	7103-36235	1/2	12.7	1 1/16-12	27	3.19	81.0	1.71	43.5
G25165-1008	10G-8MJ	7103-36265	5/8	15.9	3/4-16	27	2.93	74.5	1.46	37.0
G25165-1010	10G-10MJ	7103-36275	5/8	15.9	7/8-14	27	3.03	77.0	1.56	39.5
G25165-1012	10G-12MJ	7103-36285	5/8	15.9	1 1/16-12	27	3.19	81.0	1.71	43.5
G25165-1210	12G-10MJ	7103-36315	3/4	19.1	7/8-14	27	3.68	93.5	1.67	42.5
G25165-1212	12G-12MJ	7103-36325	3/4	19.1	1 1/16-12	27	3.72	94.5	1.71	43.5



Male JIC 37° Flare - Continued

Part No.	Descr.	Prod. No.	⊖		🌀	H1	L		C	
			"	mm			"	mm	"	mm
G25165-1214	12G-14MJ	7103-36335	3/4	19.1	1 3/16-12	32	3.76	95.5	1.75	44.5
G25165-1216	12G-16MJ	7103-36345	3/4	19.1	1 5/16-12	36	3.78	96.0	1.77	45.0
G25165-1614	16G-14MJ	7103-36375	1	25.4	1 3/16-12	36	4.09	104.0	1.86	47.2
G25165-1616	16G-16MJ	7103-36385	1	25.4	1 5/16-12	36	4.11	104.5	1.88	47.7
G25165-1620	16G-20MJ	7103-36395	1	25.4	1 5/8-12	46	4.29	109.0	2.06	52.2
G25165-2020	20G-20MJ	7103-36435	1 1/4	31.8	1 5/8-12	46	4.43	112.5	2.11	53.5
G25165-2024	20G-24MJ	7103-36445	1 1/4	31.8	1 7/8-12	50	4.43	112.5	2.11	53.5

Female JIC 37° Flare Swivel

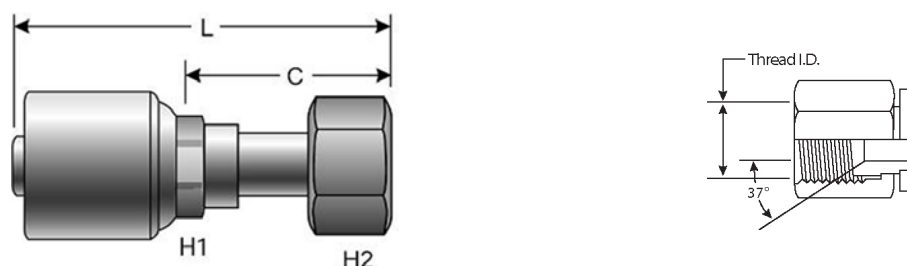

Part No.	Descr.	Prod. No.	⊖		🌀	H1	H2	L		C	
			"	mm				"	mm	"	mm
G25170-0404	4G-4FJX	7103-08045	1/4	6.4	7/16-20	15	14	2.20	55.9	1.18	29.9
G25170-0405	4G-5FJX	7103-08055	1/4	6.4	1/2-20	15	17	2.30	58.3	1.27	32.3
G25170-0406	4G-6FJX	7103-08065	1/4	6.4	9/16-18	15	19	2.35	59.6	1.32	33.6
G25170-0505	5G-5FJX	7103-09095	5/16	7.9	1/2-20	17	17	2.44	62.1	1.34	34.1
G25170-0506	5G-6FJX	7103-09105	5/16	7.9	9/16-18	17	19	2.50	63.6	1.40	35.6
G25170-0604	6G-4FJXSP	7103-10125	3/8	9.5	7/16-20	17	14	2.30	58.4	1.20	30.5
G25171-0604	6G-4FJX	7103-09135	3/8	9.5	7/16-20	15.9	14	2.94	74.7	1.84	46.8
G25170-0605	6G-5FJXSP	7103-10135	3/8	9.5	1/2-20	17	17	2.27	57.7	1.17	29.8
G25171-0605	6G-5FJX	7103-09125	3/8	9.5	1/2-20	17	17	2.96	75.2	1.86	47.3
G25170-0606	6G-6FJX	7103-08145	3/8	9.5	9/16-18	18	19	2.42	61.5	1.29	32.7
G25170-0608	6G-8FJX	7103-08155	3/8	9.5	3/4-16	18	24	2.63	66.7	1.49	37.9
G25170-0610	6G-10FJX	7103-08165	3/8	9.5	7/8-14	18	27	2.76	70.0	1.62	41.2
G25170-0612	6G-12FJX	7103-09175	3/8	9.5	1 1/16-12	17	32	2.91	74.0	1.81	46.0
G25170-0806	8G-6FJXSP	7103-10195	1/2	12.7	9/16-18	22	19	2.67	67.8	1.19	30.3
G25171-0806	8G-6FJX	7103-09195	1/2	12.7	9/16-18	22	19	3.81	96.7	2.33	59.2
G25170-0808	8G-8FJX	7103-08205	1/2	12.7	3/4-16	22	24	2.88	73.2	1.50	38.0
G25170-0810	8G-10FJX	7103-08215	1/2	12.7	7/8-14	22	27	3.01	76.5	1.63	41.3
G25170-0812	8G-12FJX	7103-08225	1/2	12.7	1 1/16-12	22	32	3.06	77.7	1.67	42.5
G25170-0816	8G-16FJX	7103-09235	1/2	12.7	1 5/16-12	22	41	3.52	89.3	2.04	51.8
G25170-1008	10G-8FJXSP	7103-10255	5/8	15.9	3/4-16	24	24	2.90	73.6	1.42	36.1
G25171-1008	10G-8FJX	7103-09255	5/8	15.9	3/4-16	24	24	4.06	103.0	2.58	65.5
G25170-1010	10G-10FJX	7103-08265	5/8	15.9	7/8-14	24	27	3.14	79.7	1.66	42.2
G25170-1012	10G-12FJX	7103-08275	5/8	15.9	1 1/16-12	24	32	3.20	81.4	1.73	43.9
G25170-1014	10G-14FJX	7103-08285	5/8	15.9	1 3/16-12	24	36	3.39	86.1	1.91	48.6
G25170-1208	12G-8FJX	7103-10305	3/4	19.1	3/4-16	27	24	3.51	89.1	1.50	38.1
G25170-1210	12G-10FJXSP	7103-10315	3/4	19.1	7/8-14	27	27	3.51	89.2	1.50	38.2
G25171-1210	12G-10FJX	7103-09315	3/4	19.1	7/8-14	27	27	4.80	122.0	2.80	71.0
G25170-1212	12G-12FJX	7103-08325	3/4	19.1	1 1/16-12	30	32	3.74	95.0	1.73	44.0
G25170-1214	12G-14FJX	7103-08335	3/4	19.1	1 3/16-12	30	36	3.81	96.9	1.81	45.9
G25170-1216	12G-16FJX	7103-08345	3/4	19.1	1 5/16-12	30	41	3.85	97.9	1.85	46.9

EQUIPMENT
HOSE/CPLG. SELECTION
G8K COUPLINGS
GLOBAL SPIRAL COUPLINGS
STAINLESS STEEL SPIRAL
MEGACRIMP COUPLINGS
STAINLESS STEEL BRAID
POWER CRIMP COUPLINGS
FIELD ATTACHABLE G1 & G2 COUPLINGS
FIELD ATTACHABLE C5 COUPLINGS
C14 COUPLINGS
GL COUPLINGS
GLX COUPLINGS
PCTS THERMOPLASTIC COUPLINGS
POLARSEAL COUPLINGS (ACA)
POLARSEAL II COUPLINGS (ACC)
POLARSEAL II COUPLINGS (ACB)
POWER STEERING
ADAPTERS
QUICK DISCONNECT COUPLERS
BALL VALVES
LIVE SWIVEL
ASSEMBLY FABRICATION
ACCESSORIES
EQUIPMENT AND PARTS
KITS
AIR BRAKE HOSE ASSY
BRASS



EQUIPMENT
HOSE/CPLG. SELECTION
G8K COUPLINGS
GLOBAL SPIRAL COUPLINGS
STAINLESS STEEL SPIRAL
<b>MEGACRIMP COUPLINGS</b>
STAINLESS STEEL BRAID
POWER CRIMP COUPLINGS
FIELD ATTACHABLE G1 & G2 COUPLINGS
FIELD ATTACHABLE C5 COUPLINGS
C14 COUPLINGS
GL COUPLINGS
GLX COUPLINGS
PCTS THERMOPLASTIC COUPLINGS
POLARSEAL COUPLINGS (ACA)
POLARSEAL II COUPLINGS (ACC)
POLARSEAL II COUPLINGS (ACB)
POWER STEERING
ADAPTERS
QUICK DISCONNECT COUPLERS
BALL VALVES
LIVE SWIVEL
ASSEMBLY FABRICATION
ACCESSORIES
EQUIPMENT AND PARTS
KITS
AIR BRAKE HOSE ASSY
BRASS

Female JIC 37° Flare Swivel - Continued

Part No.	Descr.	Prod. No.	⊖		H1	H2	L		C		
			"	mm			"	mm	"	mm	"
G25170-1612	16G-12FJXSP	7103-10375	1	25.4	1 1/16-12	36	32	4.02	102.0	1.78	45.2
G25171-1612	16G-12FJX	7103-09375	1	25.4	1 1/16-12	36	32	5.87	149.1	3.64	92.4
G25170-1614	16G-14FJXSP	7103-10385	1	25.4	1 3/16-12	36	36	4.02	102.1	1.78	45.3
G25171-1614	16G-14FJX	7103-09385	1	25.4	1 3/16-12	36	36	6.31	160.4	4.08	103.6
G25170-1616	16G-16FJX	7103-08395	1	25.4	1 5/16-12	36	41	4.24	107.8	2.01	51.0
G25170-1620	16G-20FJX	7103-08405	1	25.4	1 5/8-12	36	50	4.54	115.3	2.30	58.5
G25170-2020	20G-20FJX	7103-08435	1 1/4	31.8	1 5/8-12	41	50	4.42	112.3	2.10	53.3
G25170-2024	20G-24FJX	7103-08445	1 1/4	31.8	1 7/8-12	41	60	4.86	123.4	2.14	64.4

Female JIC 37° Flare Swivel - 30° Bent Tube

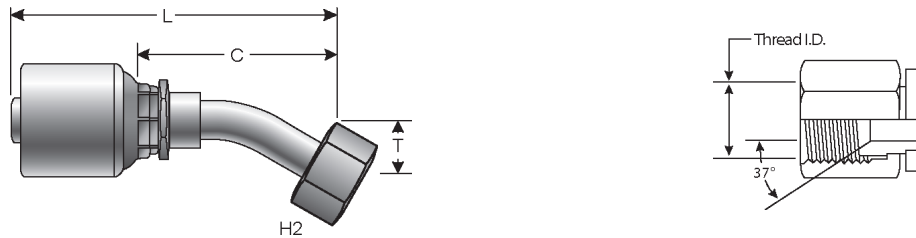

Part No.	Descr.	Prod. No.	⊖		H2	T		L		C		
			"	mm		"	mm	"	mm	"	mm	
G25172-1012	10G-12FJX30-018	7103-57005	5/8	15.9	1 1/16-12	32	.71	18.0	4.43	112.4	2.95	74.9
G25172-1210	12G-10FJX30-018	7103-59005	3/4	19.1	7/8-14	27	.71	18.0	4.45	113.0	2.44	62.0

Female JIC 37° Flare Swivel - 45° Bent Tube

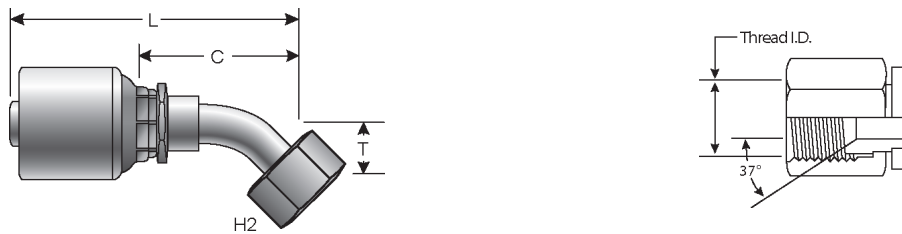

Part No.	Descr.	Prod. No.	⊖		H2	T		L		C		
			"	mm		"	mm	"	mm	"	mm	
G25175-0404	4G-4FJX45S	7103-46055	1/4	6.4	7/16-20	14	.39	10.0	2.74	69.7	1.72	43.7
G25175-0405	4G-5FJX45-011	7103-46075	1/4	6.4	1/2-20	17	.43	11.0	2.59	65.8	1.56	39.7
G25175-0406	4G-6FJX45S	7103-46135	1/4	6.4	9/16-18	19	.43	11.0	2.69	68.3	1.67	42.3
G25175-0505	5G-5FJX45-011	7103-46175	5/16	7.9	1/2-20	17	.43	11.0	2.69	68.3	1.59	40.3
G25175-0506	5G-6FJX45S	7103-46195	5/16	7.9	9/16-18	19	.43	11.0	2.85	72.4	1.75	44.4
G25175-0604	6G-4FJX45S	7103-46215	3/8	9.5	7/16-20	14	.39	10.0	2.86	72.7	1.76	44.8
G25175-0606	6G-6FJX45S	7103-46235	3/8	9.5	9/16-18	19	.43	11.0	3.05	77.5	1.95	49.6
G25175-0608	6G-8FJX45S	7103-46255	3/8	9.5	3/4-16	24	.59	15.0	3.51	89.1	2.41	61.2
G25174-0808	8G-8FJX45S	7103-46295	1/2	12.7	3/4-16	24	.59	15.0	3.42	86.9	1.95	49.5
G25175-0810	8G-10FJX45S	7103-46315	1/2	12.7	7/8-14	27	.63	16.0	3.81	96.8	2.34	59.4



Female JIC 37° Flare Swivel - 45° Bent Tube - Continued

Part No.	Descr.	Prod. No.	⊖		H2	T		L		C		
			"	mm		"	mm	"	mm	"	mm	
G25175-1010	10G-10FJX45S	7103-46355	5/8	15.9	7/8-14	27	.63	16.0	3.80	96.4	2.32	59.0
G25175-1012	10G-12FJX45S	7103-46375	5/8	15.9	1 1/16-12	32	.83	21.0	4.57	116.0	3.09	78.5
G25175-1210	12G-10FJX45S	7103-46415	3/4	19.1	7/8-14	27	.75	19.1	4.58	116.3	2.57	65.3
G25175-1212	12G-12FJX45S	7103-46425	3/4	19.1	1 1/16-12	32	.83	21.0	5.09	129.2	3.08	78.2
G25175-1216	12G-16FJX45S	7103-46455	3/4	19.1	1 5/16-12	41	.94	24.0	5.24	133.1	3.23	82.1
G25174-1612	16G-12FJX45S	7103-46495	1	25.4	1 1/16-12	32	.83	21.0	5.48	139.2	3.24	82.4
G25175-1616	16G-16FJX45S	7103-46505	1	25.4	1 5/16-12	41	.94	24.0	5.68	144.3	3.44	87.5
G25175-2020	20G-20FJX45-035	7103-46605	1 1/4	31.8	1 5/8-12	50	1.38	35.0	6.65	169.0	4.33	110.0

Female JIC 37° Flare Swivel - 90° Bent Tube

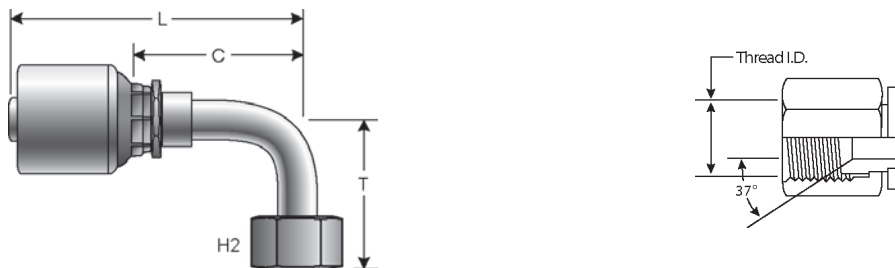

Part No.	Descr.	Prod. No.	⊖		H2	T		L		C		
			"	mm		"	mm	"	mm	"	mm	
G25179-0404	4G-4FJX90S	7103-47045	1/4	6.4	7/16-20	14	.83	21.0	2.48	63.1	1.46	37.1
G25180-0404	4G-4FJX90M	7103-47055	1/4	6.4	7/16-20	14	1.26	32.0	2.48	63.1	1.46	37.1
G25181-0404	4G-4FJX90L	7103-47065	1/4	6.4	7/16-20	14	1.81	46.0	2.48	63.1	1.46	37.1
G25179-0405	4G-5FJX90-023	7103-47075	1/4	6.4	1/2-20	17	.91	23.0	2.45	62.2	1.43	36.2
G25180-0405	4G-5FJX90M	7103-47095	1/4	6.4	1/2-20	17	1.26	32.0	2.25	57.2	1.23	31.2
G25181-0405	4G-5FJX90L	7103-47105	1/4	6.4	1/2-20	17	1.81	46.0	2.25	57.2	1.23	31.2
G25179-0406	4G-6FJX90S	7103-47125	1/4	6.4	9/16-18	19	.91	23.0	2.80	71.2	1.78	45.1
G25180-0406	4G-6FJX90M	7103-47135	1/4	6.4	9/16-18	19	1.50	38.0	2.56	64.9	1.53	38.9
G25181-0406	4G-6FJX90L	7103-47145	1/4	6.4	9/16-18	19	2.13	54.0	2.73	69.3	1.70	43.2
G25179-0506	5G-6FJX90S	7103-47165	5/16	7.9	9/16-18	19	.91	23.0	2.96	75.2	1.86	47.2
G25180-0506	5G-6FJX90M	7103-47175	5/16	7.9	9/16-18	19	1.50	38.0	2.99	76.0	1.89	48.0
G25179-0604	6G-4FJX90S	7103-47195	3/8	9.5	7/16-20	14	.83	21.0	2.60	66.1	1.50	38.2
G25181-0604	6G-4FJX90L	7103-47635	3/8	9.5	7/16-20	14	1.81	46.0	2.37	60.2	1.27	32.3
G25179-0606	6G-6FJX90S	7103-47205	3/8	9.5	9/16-18	19	.91	23.0	3.09	78.6	1.99	50.7
G25180-0606	6G-6FJX90M	7103-47215	3/8	9.5	9/16-18	19	1.50	38.0	3.01	76.5	1.91	48.5
G25181-0606	6G-6FJX90L	7103-47225	3/8	9.5	9/16-18	19	2.13	54.0	2.78	70.6	1.68	42.7
G25179-0608	6G-8FJX90S	7103-47245	3/8	9.5	3/4-16	24	1.14	29.0	3.18	80.7	2.08	52.8
G25180-0608	6G-8FJX90M	7103-47255	3/8	9.5	3/4-16	24	1.61	41.0	3.31	84.1	2.21	56.2
G25181-0608	6G-8FJX90L	7103-47265	3/8	9.5	3/4-16	24	2.52	64.0	3.33	84.5	2.23	56.6
G25180-0610	6G-10FJX90M	7103-47235	3/8	9.5	7/8-14	27	1.85	47.0	3.25	82.5	2.15	54.6
G25179-0806	8G-6FJX90S	7103-47275	1/2	12.7	9/16-18	19	.91	23.1	3.53	89.7	2.05	52.1
G25179-0808	8G-8FJX90S	7103-47285	1/2	12.7	3/4-16	24	1.14	29.0	3.19	81.0	1.71	43.6
G25180-0808	8G-8FJX90M	7103-47295	1/2	12.7	3/4-16	24	1.61	41.0	3.04	77.3	1.30	32.9
G25181-0808	8G-8FJX90L	7103-47305	1/2	12.7	3/4-16	24	2.52	64.0	3.04	77.3	1.57	39.9
G25179-0810	8G-10FJX90S	7103-47325	1/2	12.7	7/8-14	27	1.26	32.0	3.67	93.3	2.20	55.8
G25180-0810	8G-10FJX90M	7103-47335	1/2	12.7	7/8-14	27	1.85	47.0	3.67	93.3	2.20	55.8
G25181-0810	8G-10FJX90L	7103-47345	1/2	12.7	7/8-14	27	2.76	70.0	3.67	93.3	2.20	55.8
G25183-0810	8G-10FJX90-089	7103-47655	1/2	12.7	7/8-14	27	3.50	89.0	3.65	92.8	2.18	55.3
G25179-0812	8G-12FJX90S	7103-47355	1/2	12.7	1 1/16-12	32	1.89	48.0	4.28	108.7	2.80	71.1

EQUIPMENT
HOSE/CPLG. SELECTION
G8K COUPLINGS
GLOBAL SPIRAL COUPLINGS
STAINLESS STEEL SPIRAL
MEGACRIMP COUPLINGS
STAINLESS STEEL BRAID
POWER CRIMP COUPLINGS
FIELD ATTACHABLE G1 & G2 COUPLINGS
FIELD ATTACHABLE C5 COUPLINGS
C14 COUPLINGS
GL COUPLINGS
GLX COUPLINGS
PCTS THERMOPLASTIC COUPLINGS
POLARSEAL COUPLINGS (ACA)
POLARSEAL II COUPLINGS (ACC)
POLARSEAL II COUPLINGS (ACB)
POWER STEERING
ADAPTERS
QUICK DISCONNECT COUPLERS
BALL VALVES
LIVE SWIVEL
ASSEMBLY FABRICATION
ACCESSORIES
EQUIPMENT AND PARTS
KITS
AIR BRAKE HOSE ASSY
BRASS



Female JIC 37° Flare Swivel - 90° Bent Tube - Continued

Part No.	Descr.	Prod. No.	⊖		🌀		H2		T		L		C	
			"	mm	"	mm	"	mm	"	mm	"	mm	"	mm
G25179-1010	10G-10FJX90-036	7103-47675	5/8	15.9	7/8-14	27	1.42	36.0	3.50	89.0	2.03	51.5		
G25180-1010	10G-10FJX90M	7103-47375	5/8	15.9	7/8-14	27	1.85	47.0	3.68	93.4	2.20	55.9		
G25181-1010	10G-10FJX90L	7103-47385	5/8	15.9	7/8-14	27	2.76	70.0	3.38	85.9	1.91	48.4		
G25179-1012	10G-12FJX90S	7103-47405	5/8	15.9	1 1/16-12	32	1.89	48.0	4.22	107.3	2.75	69.8		
G25180-1012	10G-12FJX90M	7103-47415	5/8	15.9	1 1/16-12	32	2.28	58.0	4.03	102.3	1.80	45.8		
G25181-1012	10G-12FJX90L	7103-47425	5/8	15.9	1 1/16-12	32	3.78	96.0	4.56	115.7	3.08	78.2		
G25180-1210	12G-10FJX90M	7103-47435	3/4	19.1	7/8-14	27	1.85	47.0	4.49	114.1	2.48	63.1		
G25179-1212	12G-12FJX90S	7103-47445	3/4	19.1	1 1/16-12	32	1.89	48.0	4.82	122.4	2.81	71.4		
G25180-1212	12G-12FJX90M	7103-47455	3/4	19.1	1 1/16-12	32	2.28	58.0	4.82	122.4	2.81	71.4		
G25181-1212	12G-12FJX90L	7103-47465	3/4	19.1	1 1/16-12	32	3.78	96.0	4.82	122.4	2.81	71.4		
G25179-1214	12G-14FJX90-054	7103-47615	3/4	19.1	1 3/16-12	36	2.13	54.0	4.88	124.0	2.87	73.0		
G25181-1214	12G-14FJX90-100	7103-47625	3/4	19.1	1 3/16-12	36	3.94	100.0	4.23	107.4	2.22	56.4		
G25179-1216	12G-16FJX90S	7103-47475	3/4	19.1	1 5/16-12	41	2.20	56.0	5.22	132.7	3.22	81.7		
G25180-1216	12G-16FJX90M	7103-47515	3/4	19.1	1 5/16-12	41	2.80	71.0	4.78	121.3	2.77	70.3		
G25179-1616	16G-16FJX90S	7103-47485	1	25.4	1 5/16-12	41	2.20	56.0	5.73	145.6	3.50	88.8		
G25180-1616	16G-16FJX90M	7103-47495	1	25.4	1 5/16-12	41	2.80	71.0	4.73	120.2	2.50	63.4		
G25181-1616	16G-16FJX90L	7103-47505	1	25.4	1 5/16-12	41	4.49	114.0	4.74	120.3	2.50	63.5		
G25179-1620	16G-20FJX90S	7103-47535	1	25.4	1 5/8-12	50	2.52	64.0	6.18	157.0	3.94	100.2		
G25180-2020	20G-20FJX90M	7103-47575	1 1/4	31.8	1 5/8-12	50	3.07	78.0	6.26	159.0	3.94	100.1		
G25181-2020	20G-20FJX90L	7103-47585	1 1/4	31.8	1 5/8-12	50	5.08	129.0	6.22	158.0	3.90	99.0		
G25183-2020	20G-20FJX90-089	7103-47595	1 1/4	31.8	1 5/8-12	50	3.50	89.0	6.22	157.8	3.89	98.8		

Female JIC 37° Flare Swivel - 90° Block

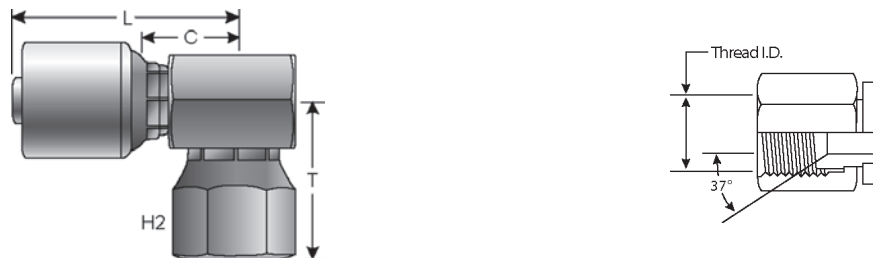

Part No.	Descr.	Prod. No.	⊖		🌀		H2		T		L		C	
			"	mm	"	mm	"	mm	"	mm	"	mm	"	mm
G25187-1216	12G-16FJX90BLK	7103-59015	3/4	19.1	1 5/16-12	1 3/8	2.09	53.2	4.53	115.0	1.73	44.0		

EQUIPMENT
HOSE/CPLG. SELECTION
G8K COUPLINGS
GLOBAL SPIRAL COUPLINGS
STAINLESS STEEL SPIRAL
MEGACRIMP COUPLINGS
STAINLESS STEEL BRAID
POWER CRIMP COUPLINGS
FIELD ATTACHABLE G1 & G2 COUPLINGS
FIELD ATTACHABLE C5 COUPLINGS
C14 COUPLINGS
GL COUPLINGS
GLX COUPLINGS
PCTS THERMOPLASTIC COUPLINGS
POLARSEAL COUPLINGS (ACA)
POLARSEAL II COUPLINGS (ACC)
POLARSEAL II COUPLINGS (ACB)
POWER STEERING
ADAPTERS
QUICK DISCONNECT COUPLERS
BALL VALVES
LIVE SWIVEL
ASSEMBLY FABRICATION
ACCESSORIES
EQUIPMENT AND PARTS
KITS
AIR BRAKE HOSE ASSY
BRASS





### Male SAE 45° Flare

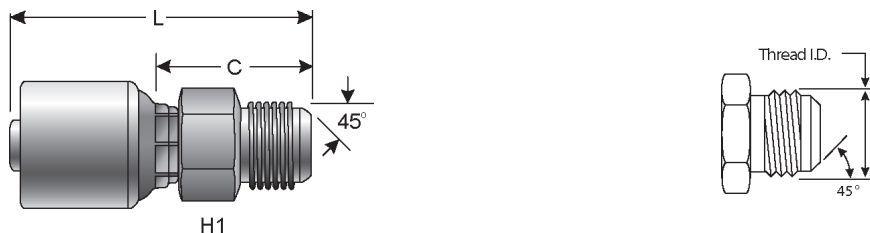

Part No.	Descr.	Prod. No.	⌀		H1	L		C		
			"	mm		"	"	mm	"	mm
G25195-0404	4G-4MS	7100-11815	1/4	6.4	7/16-20	1/2	2.50	63.5	1.08	27.5
G25195-0405	4G-5MS	7100-11825	1/4	6.4	1/2-20	1/2	2.16	54.8	1.13	28.8
G25195-0606	6G-6MS	7100-11835	3/8	9.5	5/8-18	5/8	2.38	60.5	1.28	32.6
G25195-0608	6G-8MS	7100-11845	3/8	9.5	3/4-16	13/16	2.42	61.4	1.31	33.4
G25195-0808	8G-8MS	7100-01855	1/2	12.7	3/4-16	13/16	2.89	73.5	1.42	36.0
G25195-0810	8G-10MS	7100-01865	1/2	12.7	7/8-14	7/8	3.03	77.0	1.56	39.5
G25195-1212	12G-12MS	7100-01875	3/4	19.1	1 1/16-14	1 1/16	3.78	96.0	1.77	45.0

### Female SAE 45° Flare Swivel



Part No.	Descr.	Prod. No.	⌀		H1	H2	L		C		
			"	mm			"	"	mm	"	mm
G25200-0404	4G-4FSX	7100-11885	1/4	6.4	7/16-20	1/2	9/16	2.24	57.0	1.22	31.0
G25200-0405	4G-5FSX	7100-11895	1/4	6.4	1/2-20	1/2	11/16	2.21	56.2	1.19	30.2
G25200-0406	4G-6FSX	7100-11905	1/4	6.4	5/8-18	5/8	3/4	2.31	58.7	1.28	32.6
G25200-0506	5G-6FSX	7100-11935	5/16	7.9	5/8-18	5/8	3/4	2.44	62.1	1.34	34.1
G25200-0606	6G-6FSX	7100-11915	3/8	9.5	5/8-18	5/8	3/4	2.44	62.1	1.35	34.2
G25200-0608	6G-8FSX	7100-11925	3/8	9.5	3/4-16	11/16	7/8	2.48	63.1	1.38	35.1
G25200-0808	8G-8FSX	7100-01935	1/2	12.7	3/4-16	13/16	7/8	2.82	71.6	1.34	34.1
G25200-0810	8G-10FSX	7100-01945	1/2	12.7	7/8-14	13/16	1 1/16	2.99	75.9	1.51	38.4
G25200-1212	12G-12FSX	7100-01955	3/4	19.1	1 1/16-14	1 1/16	1 1/4	3.68	93.5	1.67	42.5

- EQUIPMENT
- HOSE/CPLG. SELECTION
- G8K COUPLINGS
- GLOBALSPIRAL COUPLINGS
- STAINLESS STEEL SPIRAL
- MEGACRIMP COUPLINGS**
- STAINLESS STEEL BRAID
- POWER CRIMP COUPLINGS
- FIELD ATTACHABLE G1 & G2 COUPLINGS
- FIELD ATTACHABLE C5 COUPLINGS
- C14 COUPLINGS
- GL COUPLINGS
- GLX COUPLINGS
- PCTS THERMOPLASTIC COUPLINGS
- POLARSEAL COUPLINGS (ACA)
- POLARSEAL II COUPLINGS (ACC)
- POLARSEAL II COUPLINGS (ACB)
- POWER STEERING
- ADAPTERS
- QUICK DISCONNECT COUPLERS
- BALL VALVES
- LIVE SWIVEL
- ASSEMBLY FABRICATION
- ACCESSORIES
- EQUIPMENT AND PARTS
- KITS
- AIR BRAKE HOSE ASSY
- BRASS



EQUIPMENT
HOSE/CPLG. SELECTION
G8K COUPLINGS
GLOBALSPIRAL COUPLINGS
STAINLESS STEEL SPIRAL
<b>MEGACRIMP COUPLINGS</b>
STAINLESS STEEL BRAID
POWER CRIMP COUPLINGS
FIELD ATTACHABLE G1 & G2 COUPLINGS
FIELD ATTACHABLE C5 COUPLINGS
C14 COUPLINGS
GL COUPLINGS
GLX COUPLINGS
PCTS THERMOPLASTIC COUPLINGS
POLARSEAL COUPLINGS (ACA)
POLARSEAL II COUPLINGS (ACC)
POLARSEAL II COUPLINGS (ACB)
POWER STEERING
ADAPTERS
QUICK DISCONNECT COUPLERS
BALL VALVES
LIVE SWIVEL
ASSEMBLY FABRICATION
ACCESSORIES
EQUIPMENT AND PARTS
KITS
AIR BRAKE HOSE ASSY
BRASS

### Female SAE 45° Flare Swivel - 45° Bent Tube

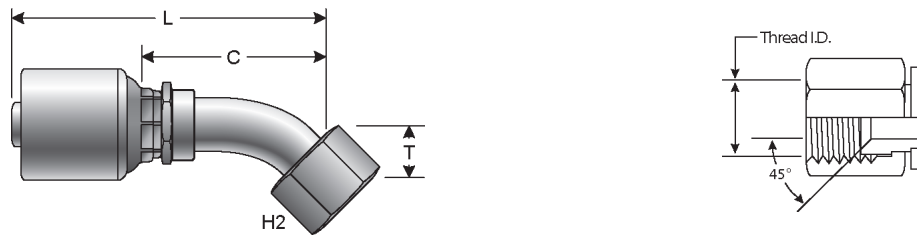

Part No.	Descr.	Prod. No.	⊖		H2	T		L		C		
			"	mm		"	mm	"	mm	"	mm	
G25202-0404	4G-4FSX45	7100-11965	1/4	6.4	7/16-20	1 9/16	.33	8.4	2.34	59.5	1.32	33.5
G25202-0405	4G-5FSX45-009	7100-01965	1/4	6.4	1/2-20	5/8	.36	9.1	2.63	66.9	1.61	40.9
G25202-0606	6G-6FSX45	7100-11995	3/8	9.5	5/8-18	3/4	.39	10.0	2.74	69.5	1.64	41.6
G25202-0608	6G-8FSX45-014	7100-02035	3/8	9.5	3/4-16	7/8	.55	14.0	3.46	87.8	2.36	59.9
G25202-0808	8G-8FSX45	7100-02015	1/2	12.7	3/4-16	7/8	.55	14.0	3.31	84.0	1.83	46.5
G25202-0810	8G-10FSX45-016	7100-02055	1/2	12.7	7/8-14	1	.63	16.0	3.67	93.1	2.19	55.6
G25202-1212	12G-12FSX45	7100-02045	3/4	19.1	1 1/16-14	1 1/4	.78	19.8	4.37	111.0	2.36	60.0

### Female SAE 45° Flare Swivel - 90° Bent Tube

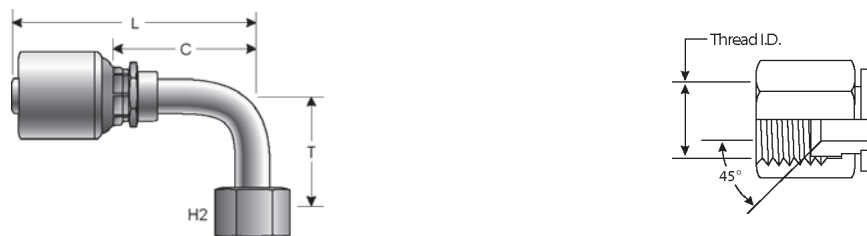

Part No.	Descr.	Prod. No.	⊖		H2	T		L		C		
			"	mm		"	mm	"	mm	"	mm	
G25205-0404	4G-4FSX90	7100-12055	1/4	6.4	7/16-20	9/16	1.24	31.5	2.05	52.0	1.02	26.0
G25205-0405	4G-5FSX90-046	7100-01985	1/4	6.4	1/2-20	5/8	1.80	45.7	2.47	62.8	1.45	36.8
G25204-0506	5G-6FSX90-022	7100-02005	5/16	7.9	5/8-18	3/4	.85	21.6	2.77	70.4	1.67	42.4
G25205-0606	6G-6FSX90	7100-12105	3/8	9.5	5/8-18	3/4	1.52	38.5	2.36	60.0	1.26	32.1
G25206-0606	6G-6FSX90-055	7100-01995	3/8	9.5	5/8-18	3/4	2.18	55.4	2.83	71.8	1.73	43.9
G25205-0608	6G-8FSX90	7100-02125	3/8	9.5	3/4-16	7/8	1.75	44.5	2.50	63.5	1.40	35.6
G25205-0808	8G-8FSX90	7100-02135	1/2	12.7	3/4-16	7/8	1.75	44.5	2.93	74.5	1.46	37.0
G25204-0810	8G-10FSX90-031	7100-02065	1/2	12.7	7/8-14	1	1.23	31.2	3.29	83.5	1.81	46.0
G25205-1212	12G-12FSX90	7100-02185	3/4	19.1	1 1/16-14	1 1/4	2.78	70.6	3.94	100.0	1.93	49.0



### Male Flat-Face O-Ring

SAE J1453 Captive O-Ring Groove for Improved O-Ring Retention.

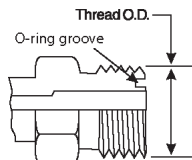
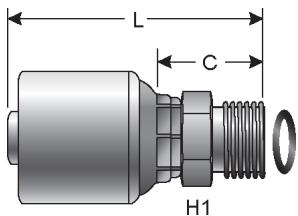

Part No.	Descr.	Prod. No.	⊖		H1	L		C		
			"	mm		"	mm	"	mm	
G25225-0404	4G-4MFFOR	7104-16045	1/4	6.4	9/16-18	17	2.07	52.5	1.04	26.5
G25225-0406	4G-6MFFOR	7104-16055	1/4	6.4	11/16-16	19	2.13	54.0	1.10	28.0
G25225-0506	5G-6MFFOR	7104-16065	5/16	7.9	11/16-16	19	2.20	56.0	1.10	28.0
G25225-0606	6G-6MFFOR	7104-16075	3/8	9.5	11/16-16	19	2.20	56.0	1.11	28.1
G25225-0608	6G-8MFFOR	7104-16085	3/8	9.5	13/16-16	22	2.32	59.0	1.22	31.1
G25225-0610	6G-10MFFOR	7104-16095	3/8	9.5	1-14	27	2.52	64.0	1.42	36.1
G25225-0808	8G-8MFFOR	7104-16115	1/2	12.7	13/16-16	22	2.69	68.2	1.21	30.7
G25225-0810	8G-10MFFOR	7104-16125	1/2	12.7	1-14	27	2.87	73.0	1.40	35.5
G25225-0812	8G-12MFFOR	7104-16135	1/2	12.7	1 3/16-12	32	3.01	76.5	1.54	39.0
G25225-1010	10G-10MFFOR	7104-16155	5/8	15.9	1-14	27	2.87	73.0	1.40	35.5
G25225-1012	10G-12MFFOR	7104-16165	5/8	15.9	1 3/16-12	32	3.03	77.0	1.56	39.5
G25225-1212	12G-12MFFOR	7104-16185	3/4	19.1	1 3/16-12	32	3.54	90.0	1.54	39.0
G25225-1216	12G-16MFFOR	7104-16195	3/4	19.1	1 7/16-12	41	3.74	95.0	1.73	44.0
G25225-1616	16G-16MFFOR	7104-16215	1	25.4	1 7/16-12	41	4.02	102.0	1.78	45.2
G25225-1620	16G-20MFFOR	7104-16225	1	25.4	1 11/16-12	46	4.13	105.0	1.90	48.2
G25225-2020	20G-20MFFOR	7104-16245	1 1/4	31.8	1 11/16-12	46	4.29	109.0	1.97	50.0

### Male Flat-Face O-Ring Bulk Head Long Nose

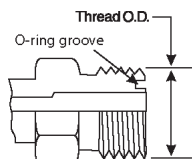
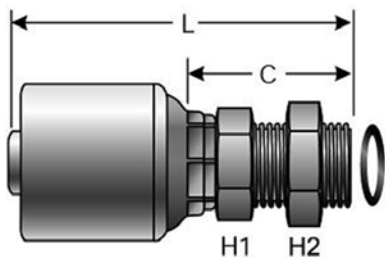

Part No.	Descr.	Prod. No.	⊖		H1	H2	L		C		
			"	mm			"	mm	"	mm	
G25226-0606	6G-6MFFORBKHDLN	7104-17075	3/8	9.5	11/16-16	27	27	3.07	78.1	1.98	50.2
G25226-0808	8G-8MFFORBKHDLN	7104-17115	1/2	12.7	13/16-16	30	30	3.55	90.2	2.07	52.7

- EQUIPMENT
- HOSE/CPLG. SELECTION
- G8K COUPLINGS
- GLOBALSPIRAL COUPLINGS
- STAINLESS STEEL SPIRAL
- MEGACRIMP COUPLINGS**
- STAINLESS STEEL BRAID
- POWER CRIMP COUPLINGS
- FIELD ATTACHABLE G1 & G2 COUPLINGS
- FIELD ATTACHABLE C5 COUPLINGS
- C14 COUPLINGS
- GL COUPLINGS
- GLX COUPLINGS
- PCTS THERMOPLASTIC COUPLINGS
- POLARSEAL COUPLINGS (ACA)
- POLARSEAL II COUPLINGS (ACC)
- POLARSEAL II COUPLINGS (ACB)
- POWER STEERING
- ADAPTERS
- QUICK DISCONNECT COUPLERS
- BALL VALVES
- LIVE SWIVEL
- ASSEMBLY FABRICATION
- ACCESSORIES
- EQUIPMENT AND PARTS
- KITS
- AIR BRAKE HOSE ASSY
- BRASS



EQUIPMENT
HOSE/CPLG. SELECTION
G8K COUPLINGS
GLOBALSPIRAL COUPLINGS
STAINLESS STEEL SPIRAL
<b>MEGACRIMP COUPLINGS</b>
STAINLESS STEEL BRAID
POWER CRIMP COUPLINGS
FIELD ATTACHABLE G1 & G2 COUPLINGS
FIELD ATTACHABLE C5 COUPLINGS
C14 COUPLINGS
GL COUPLINGS
GLX COUPLINGS
PCTS THERMOPLASTIC COUPLINGS
POLARSEAL COUPLINGS (ACA)
POLARSEAL II COUPLINGS (ACC)
POLARSEAL II COUPLINGS (ACB)
POWER STEERING
ADAPTERS
QUICK DISCONNECT COUPLERS
BALL VALVES
LIVE SWIVEL
ASSEMBLY FABRICATION
ACCESSORIES
EQUIPMENT AND PARTS
KITS
AIR BRAKE HOSE ASSY
BRASS

### Male Flat-Face O-Ring Bulk Head

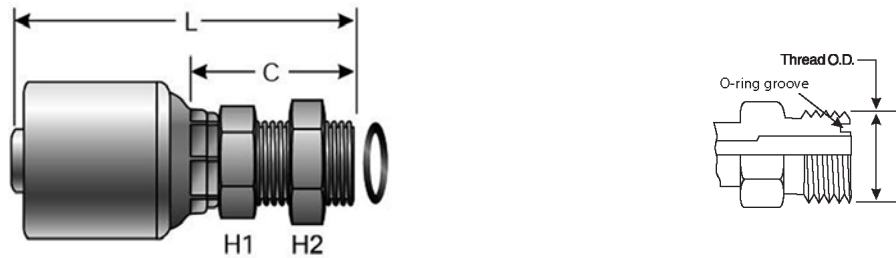

Part No.	Descr.	Prod. No.	⌀		H1	H2	L		C		
			"	mm			"	mm	"	mm	"
G25228-0404	4G-4MFFORBKHD	7104-17295	1/4	6.4	9/16-18	22	22	2.80	71.1	1.78	45.2
G25228-0606	6G-6MFFORBKHD	7104-17325	3/8	9.5	11/16-16	27	27	3.07	78.1	1.98	50.3

### Female Flat-Face O-Ring Swivel

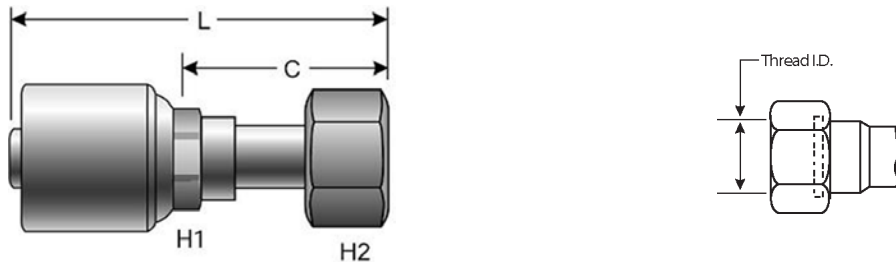

Part No.	Descr.	Prod. No.	⌀		H1	H2	L		C		
			"	mm			"	mm	"	mm	"
G25230-0404	4G-4FFORX	7104-18045	1/4	6.4	9/16-18	15	17	2.07	52.7	1.05	26.7
G25230-0406	4G-6FFORX	7104-18055	1/4	6.4	11/16-16	15	22	2.01	51.1	.99	25.1
G25230-0408	4G-8FFORX	7104-18075	1/4	6.4	13/16-16	15	24	1.99	50.5	.96	24.5
G25230-0506	5G-6FFORX	7104-19505	5/16	7.9	11/16-16	17	22	2.42	61.5	1.32	33.5
G25230-0604	6G-4FFORX	7104-19085	3/8	9.5	9/16-18	17	17	3.08	78.3	1.98	50.3
G25230-0606	6G-6FFORX	7104-18095	3/8	9.5	11/16-16	18	22	2.27	57.7	1.14	28.9
G25230-0608	6G-8FFORX	7104-18105	3/8	9.5	13/16-16	18	24	2.26	57.4	1.13	28.6
G25230-0610	6G-10FFORX	7104-18115	3/8	9.5	1-14	18	30	2.15	54.7	1.02	25.9
G25230-0806	8G-6FFORX	7104-19145	1/2	12.7	11/16-16	22	22	3.78	95.9	2.30	58.4
G25230-0808	8G-8FFORX	7104-18155	1/2	12.7	13/16-16	22	24	2.62	66.5	1.23	31.3
G25230-0810	8G-10FFORX	7104-18165	1/2	12.7	1-14	22	30	2.76	70.0	1.37	34.8
G25230-0812	8G-12FFORX	7104-18175	1/2	12.7	1 3/16-12	22	36	2.81	71.5	1.43	36.3
G25230-1008	10G-8FFORX	7104-19195	5/8	15.9	13/16-16	24	24	3.83	97.2	2.35	59.7
G25230-1010	10G-10FFORX	7104-18205	5/8	15.9	1-14	24	30	2.99	76.0	1.52	38.5
G25230-1012	10G-12FFORX	7104-18215	5/8	15.9	1 3/16-12	24	36	3.03	77.0	1.56	39.5
G25230-1210	12G-10FFORX	7104-19245	3/4	19.1	1-14	30	30	3.74	95.1	1.74	44.1
G25230-1212	12G-12FFORX	7104-18255	3/4	19.1	1 3/16-12	30	36	3.65	92.8	1.65	41.8
G25230-1216	12G-16FFORX	7104-18265	3/4	19.1	1 7/16-12	30	41	3.48	88.3	1.47	37.3
G25230-1612	16G-12FFORX	7104-19295	1	25.4	1 3/16-12	36	36	5.58	141.8	3.35	85.0
G25230-1616	16G-16FFORX	7104-18305	1	25.4	1 7/16-12	36	41	4.09	104.0	1.86	47.2
G25230-1620	16G-20FFORX	7104-18315	1	25.4	1 11/16-12	36	50	4.06	103.0	1.82	46.2
G25230-2020	20G-20FFORX	7104-18355	1 1/4	31.8	1 11/16-12	41	50	4.29	109.0	1.97	50.0
G25230-2024	20G-24FFORX	7104-18385	1 1/4	31.8	2-12	41	60	4.09	104.0	1.77	45.0



### Female Flat-Face O-Ring Swivel - 30° Bent Tube

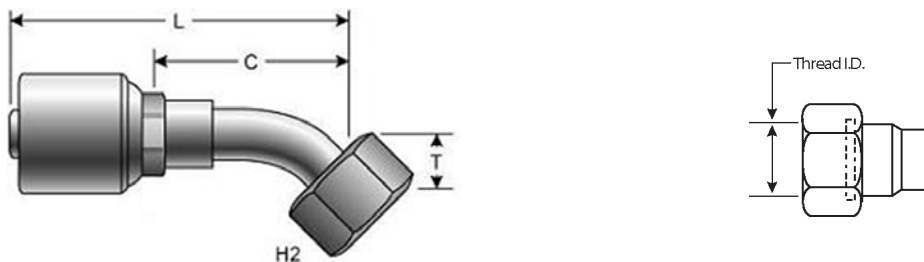

Part No.	Descr.	Prod. No.	⌀		H2	T		L		C		
			"	mm		"	mm	"	mm	"	mm	
G25233-0810	8G-10FFORX30-010	7104-07025	1/2	12.7	1-14	30	.38	9.7	3.65	92.7	2.18	55.3

### Female Flat-Face O-Ring Swivel - 45° Bent Tube

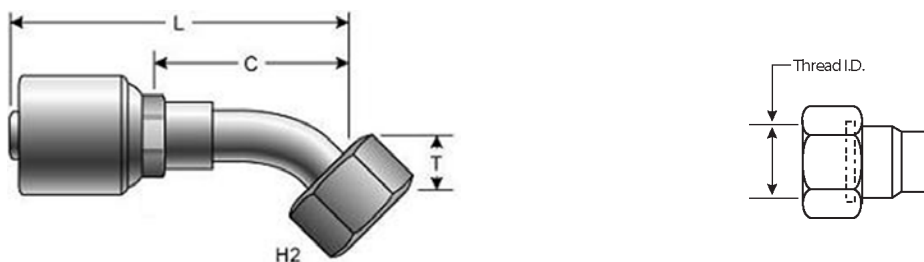

Part No.	Descr.	Prod. No.	⌀		H2	T		L		C		
			"	mm		"	mm	"	mm	"	mm	
G25235-0404	4G-4FFORX45S	7104-22045	1/4	6.4	9/16-18	17	.39	10.0	2.57	65.2	1.54	39.2
G25235-0406	4G-6FFORX45S	7104-22055	1/4	6.4	11/16-16	22	.43	11.0	2.70	68.5	1.67	42.5
G25235-0506	5G-6FFORX45S	7104-22335	5/16	7.9	11/16-16	22	.43	11.0	2.73	69.4	1.63	41.4
G25235-0604	6G-4FFORX45S	7104-22075	3/8	9.5	9/16-18	17	.39	10.0	2.60	66.1	1.50	38.1
G25235-0606	6G-6FFORX45S	7104-22085	3/8	9.5	11/16-16	22	.43	11.0	2.75	69.8	1.65	41.9
G25235-0608	6G-8FFORX45S	7104-22095	3/8	9.5	13/16-16	24	.59	15.0	3.35	85.2	2.26	57.3
G25234-0806	8G-6FFORX45S	7104-22125	1/2	12.7	11/16-16	22	.43	11.0	3.57	90.7	2.09	53.2
G25235-0808	8G-8FFORX45S	7104-22135	1/2	12.7	13/16-16	24	.59	15.0	3.50	89.0	2.03	51.6
G25235-0810	8G-10FFORX45S	7104-22145	1/2	12.7	1-14	30	.63	16.0	3.98	101.0	2.50	63.5
G25235-0812	8G-12FFORX45S	7104-22155	1/2	12.7	1 3/16-12	36	.83	21.0	4.34	110.3	2.87	72.8
G25235-1008	10G-8FFORX45S	7104-22165	5/8	15.9	13/16-16	24	.59	15.0	3.81	96.8	2.33	59.3
G25235-1010	10G-10FFORX45S	7104-22175	5/8	15.9	1-14	30	.63	16.0	3.96	100.5	2.48	63.0
G25235-1012	10G-12FFORX45S	7104-22185	5/8	15.9	1 3/16-12	36	.83	21.0	4.17	105.9	2.69	68.4
G25235-1210	12G-10FFORX45S	7104-22215	3/4	19.1	1-14	30	.63	16.0	4.45	113.0	2.44	62.0
G25235-1212	12G-12FFORX45S	7104-22225	3/4	19.1	1 3/16-12	36	.83	21.0	4.66	118.4	2.65	67.4
G25235-1216	12G-16FFORX45S	7104-22235	3/4	19.1	1 7/16-12	41	.94	24.0	4.80	122.0	2.80	71.0
G25235-1612	16G-12FFORX45S	7104-22255	1	25.4	1 3/16-12	36	.83	21.0	5.33	135.5	2.98	75.7
G25235-1616	16G-16FFORX45S	7104-22265	1	25.4	1 7/16-12	41	.94	24.0	5.78	146.9	3.55	90.1
G25235-2020	20G-20FFORX45S	7104-22295	1 1/4	31.8	1 11/16-12	50	.98	25.0	6.22	158.0	3.90	99.0

EQUIPMENT
HOSE/CPLG. SELECTION
G8K COUPLINGS
GLOBALSPIRAL COUPLINGS
STAINLESS STEEL SPIRAL
<b>MEGACRIMP COUPLINGS</b>
STAINLESS STEEL BRAID
POWER CRIMP COUPLINGS
FIELD ATTACHABLE G1 & G2 COUPLINGS
FIELD ATTACHABLE C5 COUPLINGS
C14 COUPLINGS
GL COUPLINGS
GLX COUPLINGS
PCTS THERMOPLASTIC COUPLINGS
POLARSEAL COUPLINGS (ACA)
POLARSEAL II COUPLINGS (ACC)
POLARSEAL II COUPLINGS (ACB)
POWER STEERING
ADAPTERS
QUICK DISCONNECT COUPLERS
BALL VALVES
LIVE SWIVEL
ASSEMBLY FABRICATION
ACCESSORIES
EQUIPMENT AND PARTS
KITS
AIR BRAKE HOSE ASSY
BRASS



EQUIPMENT
HOSE/CPLG. SELECTION
G8K COUPLINGS
GLOBAL SPIRAL COUPLINGS
STAINLESS STEEL SPIRAL
<b>MEGACRIMP COUPLINGS</b>
STAINLESS STEEL BRAID
POWER CRIMP COUPLINGS
FIELD ATTACHABLE G1 & G2 COUPLINGS
FIELD ATTACHABLE C5 COUPLINGS
C14 COUPLINGS
GL COUPLINGS
GLX COUPLINGS
PCTS THERMOPLASTIC COUPLINGS
POLARSEAL COUPLINGS (ACA)
POLARSEAL II COUPLINGS (ACC)
POLARSEAL II COUPLINGS (ACB)
POWER STEERING
ADAPTERS
QUICK DISCONNECT COUPLERS
BALL VALVES
LIVE SWIVEL
ASSEMBLY FABRICATION
ACCESSORIES
EQUIPMENT AND PARTS
KITS
AIR BRAKE HOSE ASSY
BRASS

## Female Flat-Face O-Ring Swivel - 67 1/2° Bent Tube

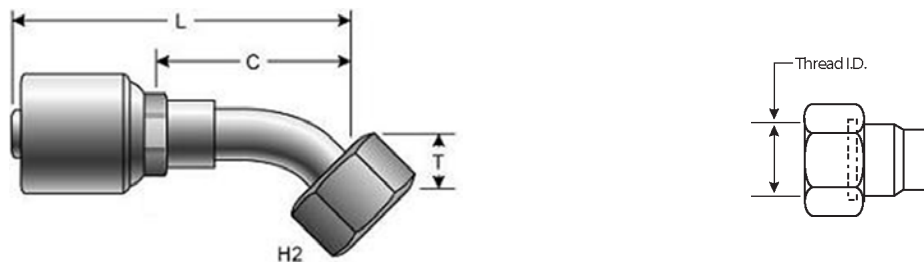

Part No.	Descr.	Prod. No.	⊖		H2	T		L		C		
			"	mm		"	mm	"	mm	"	mm	
G25238-0808	8G-8FFORX67-022	7104-07015	1/2	12.7	13/16-16	.94	.87	22.1	3.25	82.5	1.77	45.0

## Female Flat-Face O-Ring Swivel - 90° Bent Tube

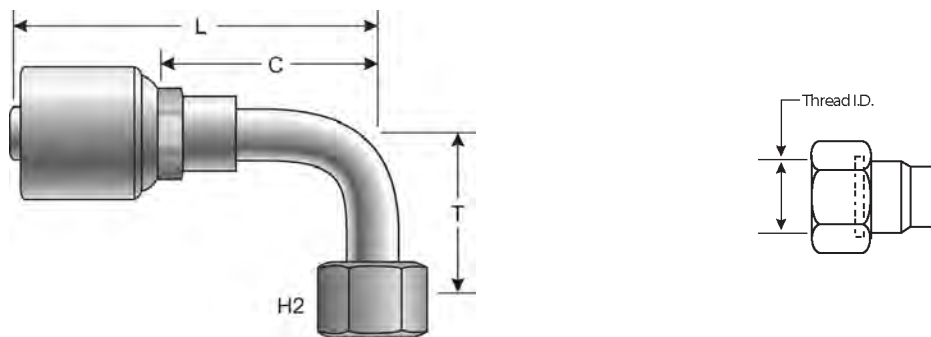

Part No.	Descr.	Prod. No.	⊖		H2	T		L		C		
			"	mm		"	mm	"	mm	"	mm	
G25239-0404	4G-4FFORX90S	7104-24045	1/4	6.4	9/16-18	17	.83	21.0	2.37	60.2	1.35	34.2
G25240-0404	4G-4FFORX90M	7104-24055	1/4	6.4	9/16-18	17	1.26	32.0	2.21	56.2	1.19	30.2
G25241-0404	4G-4FFORX90L	7104-24065	1/4	6.4	9/16-18	17	1.81	46.0	2.21	56.2	1.19	30.2
G25239-0406	4G-6FFORX90S	7104-24095	1/4	6.4	11/16-16	22	.91	23.0	2.50	63.4	1.47	37.4
G25240-0406	4G-6FFORX90M	7104-24105	1/4	6.4	11/16-16	22	1.50	38.0	2.50	63.4	1.47	37.4
G25241-0406	4G-6FFORX90L	7104-24115	1/4	6.4	11/16-16	22	2.13	54.0	2.43	61.6	1.40	35.6
G25239-0408	4G-8FFORX90S	7104-24145	1/4	6.4	13/16-16	24	1.14	29.0	2.83	72.0	1.81	46.0
G25241-0408	4G-8FFORX90L	7104-24165	1/4	6.4	13/16-16	24	2.52	64.0	2.64	67.1	1.62	41.1
G25239-0506	5G-6FFORX90S	7104-24955	5/16	7.9	11/16-16	22	.91	23.0	2.83	72.0	1.73	44.0
G25239-0604	6G-4FFORX90S	7104-24195	3/8	9.5	9/16-18	17	.83	21.0	2.42	61.4	1.32	33.6
G25239-0606	6G-6FFORX90S	7104-24245	3/8	9.5	11/16-16	22	.91	23.0	2.85	72.5	1.76	44.6
G25240-0606	6G-6FFORX90M	7104-24255	3/8	9.5	11/16-16	22	1.50	38.0	2.50	63.6	1.41	35.7
G25241-0606	6G-6FFORX90L	7104-24265	3/8	9.5	11/16-16	22	2.13	54.0	2.73	69.3	1.63	41.4
G25239-0608	6G-8FFORX90S	7104-24295	3/8	9.5	13/16-16	24	1.14	29.0	2.87	73.0	1.78	45.1
G25240-0608	6G-8FFORX90M	7104-24305	3/8	9.5	13/16-16	24	1.61	41.0	2.70	68.5	1.60	40.6
G25241-0608	6G-8FFORX90L	7104-24315	3/8	9.5	13/16-16	24	2.52	64.0	2.72	69.0	1.62	41.1
G25239-0806	8G-6FFORX90S	7104-24345	1/2	12.7	11/16-16	22	.91	23.0	3.29	83.5	1.81	46.0
G25241-0806	8G-6FFORX90L	7104-24365	1/2	12.7	11/16-16	22	2.13	54.0	3.16	80.3	1.69	42.8
G25239-0808	8G-8FFORX90S	7104-24395	1/2	12.7	13/16-16	24	1.14	29.0	3.30	83.9	1.83	46.5
G25240-0808	8G-8FFORX90M	7104-24405	1/2	12.7	13/16-16	24	1.61	41.0	3.30	83.9	1.83	46.5
G25241-0808	8G-8FFORX90L	7104-24415	1/2	12.7	13/16-16	24	2.52	64.0	3.30	83.9	1.83	46.5
G25239-0810	8G-10FFORX90S	7104-24445	1/2	12.7	1-14	30	1.26	32.0	3.66	92.9	2.18	55.4



Female Flat-Face O-Ring Swivel - 90° Bent Tube - Continued

Part No.	Descr.	Prod. No.	⊖		H2	T		L		C		
			"	mm		"	mm	"	mm	"	mm	
G25240-0810	8G-10FFORX90M	7104-24455	1/2	12.7	1-14	30	1.85	47.0	3.67	93.2	2.19	55.7
G25241-0810	8G-10FFORX90L	7104-24465	1/2	12.7	1-14	30	2.76	70.0	3.57	90.6	2.09	53.1
G25239-0812	8G-12FFORX90S	7104-24475	1/2	12.7	1 3/16-12	36	1.89	48.0	4.05	102.9	2.57	65.4
G25239-1008	10G-8FFORX90S	7104-24495	5/8	15.9	13/16-16	24	1.14	29.0	3.64	92.4	2.16	54.9
G25241-1008	10G-8FFORX90L	7104-24515	5/8	15.9	13/16-16	24	2.52	64.0	3.64	92.4	2.16	54.9
G25239-1010	10G-10FFORX90S	7104-24545	5/8	15.9	1-14	30	1.26	32.0	3.64	92.5	2.17	55.0
G25240-1010	10G-10FFORX90M	7104-24555	5/8	15.9	1-14	30	1.85	47.0	3.65	92.8	2.18	55.3
G25241-1010	10G-10FFORX90L	7104-24565	5/8	15.9	1-14	30	2.76	70.0	3.55	90.2	2.07	52.7
G25239-1012	10G-12FFORX90S	7104-24595	5/8	15.9	1 3/16-12	36	1.89	48.0	3.79	96.3	2.31	58.8
G25239-1210	12G-10FFORX90S	7104-24635	3/4	19.1	1-14	30	1.26	32.0	4.09	104.0	2.09	53.0
G25239-1212	12G-12FFORX90S	7104-24645	3/4	19.1	1 3/16-12	36	1.89	48.0	4.28	108.8	2.28	57.8
G25240-1212	12G-12FFORX90M	7104-24655	3/4	19.1	1 3/16-12	36	2.28	58.0	4.29	109.0	2.28	58.0
G25241-1212	12G-12FFORX90L	7104-24665	3/4	19.1	1 3/16-12	36	3.78	96.0	4.65	118.2	2.65	67.2
G25239-1216	12G-16FFORX90S	7104-24695	3/4	19.1	1 7/16-12	41	2.20	56.0	5.06	128.5	3.05	77.5
G25239-1612	16G-12FFORX90S	7104-24735	1	25.4	1 3/16-12	36	1.89	48.0	5.09	129.4	2.86	72.6
G25239-1616	16G-16FFORX90S	7104-24745	1	25.4	1 7/16-12	41	2.20	56.0	5.11	129.9	2.88	73.1
G25240-1616	16G-16FFORX90M	7104-24755	1	25.4	1 7/16-12	41	2.80	71.0	5.11	129.9	2.88	73.1
G25241-1616	16G-16FFORX90L	7104-24765	1	25.4	1 7/16-12	41	4.49	114.0	5.11	129.9	2.88	73.1
G25239-1620	16G-20FFORX90S	7104-24905	1	25.4	1 11/16-12	50	2.52	64.0	5.11	129.9	2.88	73.1
G25240-1620	16G-20FFORX90M	7104-24915	1	25.4	1 11/16-12	50	3.07	78.0	6.14	156.0	3.91	99.2
G25239-2020	20G-20FFORX90S	7104-24795	1 1/4	31.8	1 11/16-12	50	2.52	64.0	5.91	150.0	3.58	91.0
G25240-2020	20G-20FFORX90M	7104-24805	1 1/4	31.8	1 11/16-12	50	3.07	78.0	5.51	140.0	3.19	81.0
G25241-2020	20G-20FFORX90L	7104-24815	1 1/4	31.8	1 11/16-12	50	5.08	129.0	5.51	140.0	3.19	81.0

Code 61 O-Ring Flange

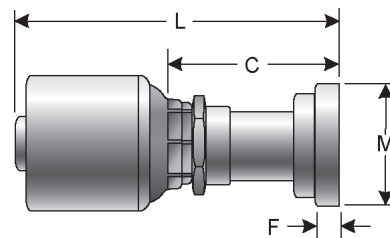

Part No.	Descr.	Prod. No.	⊖		M		L		C		F	
			"	mm	"	mm	"	mm	"	mm	"	mm
G25300-0808	8G-8FL	7103-25055	1/2	12.7	1.19	30.2	3.15	80.0	1.67	42.5	.27	6.9
G25300-0812	8G-12FL	7103-25105	1/2	12.7	1.50	38.1	3.15	80.0	1.67	42.5	.27	6.9
G25300-1212	12G-12FL	7103-25205	3/4	19.1	1.50	38.1	3.86	98.0	1.85	47.0	.27	6.9
G25300-1216	12G-16FL	7103-25255	3/4	19.1	1.75	44.5	3.50	88.8	1.49	37.8	.32	8.1
G25300-1612	16G-12FL	7103-25295	1	25.4	1.50	38.1	5.04	128.0	2.80	71.2	.27	6.9
G25300-1616	16G-16FL	7103-25305	1	25.4	1.75	44.5	4.13	105.0	1.90	48.2	.32	8.1
G25300-1620	16G-20FL	7103-25355	1	25.4	2.00	50.8	4.13	105.0	1.90	48.2	.32	8.1
G25300-1624	16G-24FL	7100-03875	1	25.4	2.38	60.5	3.78	96.0	1.54	39.2	.32	8.1
G25300-2020	20G-20FL	7103-25405	1 1/4	31.8	2.00	50.8	4.43	112.5	2.11	53.5	.32	8.1
G25300-2024	20G-24FL	7103-25455	1 1/4	31.8	2.38	60.5	4.63	117.5	2.30	58.5	.32	8.1

- EQUIPMENT
- HOSE/CPLG. SELECTION
- G8K COUPLINGS
- GLOBALSPIRAL COUPLINGS
- STAINLESS STEEL SPIRAL
- MEGACRIMP COUPLINGS**
- STAINLESS STEEL BRAID
- POWER CRIMP COUPLINGS
- FIELD ATTACHABLE G1 & G2 COUPLINGS
- FIELD ATTACHABLE C5 COUPLINGS
- C14 COUPLINGS
- GL COUPLINGS
- GLX COUPLINGS
- PCTS THERMOPLASTIC COUPLINGS
- POLARSEAL COUPLINGS (ACA)
- POLARSEAL II COUPLINGS (ACC)
- POLARSEAL II COUPLINGS (ACB)
- POWER STEERING
- ADAPTERS
- QUICK DISCONNECT COUPLERS
- BALL VALVES
- LIVE SWIVEL
- ASSEMBLY FABRICATION
- ACCESSORIES
- EQUIPMENT AND PARTS
- KITS
- AIR BRAKE HOSE ASSY
- BRASS



EQUIPMENT
HOSE/CPLG. SELECTION
G8K COUPLINGS
GLOBAL SPIRAL COUPLINGS
STAINLESS STEEL SPIRAL
<b>MEGACRIMP COUPLINGS</b>
STAINLESS STEEL BRAID
POWER CRIMP COUPLINGS
FIELD ATTACHABLE G1 & G2 COUPLINGS
FIELD ATTACHABLE C5 COUPLINGS
C14 COUPLINGS
GL COUPLINGS
GLX COUPLINGS
PCTS THERMOPLASTIC COUPLINGS
POLARSEAL COUPLINGS (ACA)
POLARSEAL II COUPLINGS (ACC)
POLARSEAL II COUPLINGS (ACB)
POWER STEERING
ADAPTERS
QUICK DISCONNECT COUPLERS
BALL VALVES
LIVE SWIVEL
ASSEMBLY FABRICATION
ACCESSORIES
EQUIPMENT AND PARTS
KITS
AIR BRAKE HOSE ASSY
BRASS

### Komatsu O-Ring Flange - Straight

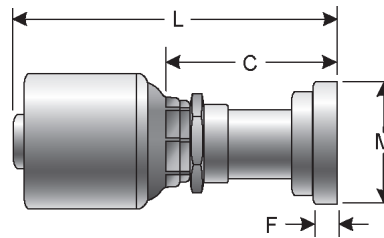

Part No.	Descr.	Prod. No.	⊖		M		L		C		F	
			"	mm	"	mm	"	mm	"	mm	"	mm
G25300-0810	8G-10FLK	7100-03805	1/2	12.7	1.35	34.3	3.15	80.0	1.67	42.5	.27	6.9
G25300-1010	10G-10FLK	7100-03825	5/8	15.9	1.35	34.3	4.69	119.0	3.21	81.5	.27	6.9

### Code 61 O-Ring Flange - 22 1/2° Bent Tube

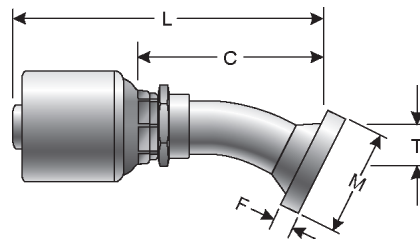

Part No.	Descr.	Prod. No.	⊖		M		T		L		C		F	
			"	mm	"	mm	"	mm	"	mm	"	mm	"	mm
G25302-1212	12G-12FL22M	7103-26155	3/4	19.1	1.50	38.1	.43	11.0	4.76	121.0	2.76	70.0	.27	6.9
G25302-1216	12G-16FL22M-014	7100-03955	3/4	19.1	1.75	44.5	.55	14.0	4.76	121.0	2.76	70.0	.32	8.1
G25302-1616	16G-16FL22M	7103-26255	1	25.4	1.75	44.5	.55	14.0	5.61	142.5	3.37	85.7	.32	8.1
G25302-2020	20G-20FL22M	7103-26355	1 1/4	31.8	2.00	50.8	.59	15.0	6.00	152.5	3.68	93.5	.32	8.1

### Code 61 O-Ring Flange - 30° Bent Tube

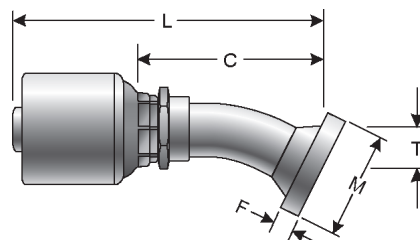

Part No.	Descr.	Prod. No.	⊖		M		T		L		C		F	
			"	mm	"	mm	"	mm	"	mm	"	mm	"	mm
G25304-1212	12G-12FL30M	7103-26655	3/4	19.1	1.50	38.1	.63	16.0	4.70	119.5	2.70	68.5	.27	6.9
G25304-1216	12G-16FL30M	7100-04045	3/4	19.1	1.75	44.5	.75	19.1	4.88	124.0	2.87	73.0	.32	8.1
G25304-1616	16G-16FL30M	7103-26755	1	25.4	1.75	44.5	.75	19.1	5.69	144.5	3.45	87.7	.32	8.1
G25304-1620	16G-20FL30M	7103-26805	1	25.4	2.00	50.8	.87	22.1	5.89	149.5	3.65	92.7	.32	8.1



Code 61 O-Ring Flange - 30° Bent Tube - Continued

Part No.	Descr.	Prod. No.	⊖		M		T		L		C		F	
			"	mm	"	mm	"	mm	"	mm	"	mm	"	mm
G25304-2020	20G-20FL30S	7103-26845	1 1/4	31.8	2.00	50.8	.79	20.1	6.04	153.4	3.72	94.4	.32	8.1

Code 61 O-Ring Flange - 45° Bent Tube

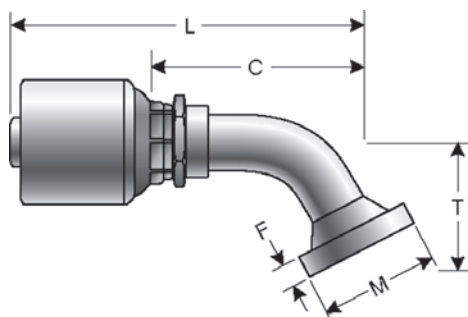

Part No.	Descr.	Prod. No.	⊖		M		T		L		C		F	
			"	mm	"	mm	"	mm	"	mm	"	mm	"	mm
G25307-0808	8G-8FL45M	7103-27085	1/2	12.7	1.19	30.2	.75	19.1	3.85	97.8	2.37	60.3	.27	6.9
G25307-0812	8G-12FL45M	7103-27165	1/2	12.7	1.50	38.1	1.02	26.0	4.13	104.8	2.65	67.3	.27	6.9
G25307-1012	10G-12FL45M	7103-27205	5/8	15.9	1.50	38.1	1.02	26.0	4.43	112.6	2.96	75.1	.27	6.9
G25307-1212	12G-12FL45M	7103-27245	3/4	19.1	1.50	38.1	1.02	26.0	4.82	122.5	2.81	71.5	.27	6.9
G25306-1216	12G-16FL45S	7103-27315	3/4	19.1	1.75	44.5	1.10	28.0	4.90	124.5	2.89	73.5	.32	8.1
G25306-1616	16G-16FL45S	7103-27395	1	25.4	1.75	44.5	1.10	28.0	5.61	142.5	3.37	85.7	.32	8.1
G25306-1620	16G-20FL45S	7103-27475	1	25.4	2.00	50.8	1.26	32.0	5.87	149.0	3.63	92.2	.32	8.1
G25307-1624	16G-24FL45	7100-07185	1	25.4	2.38	60.5	1.06	26.9	5.30	134.5	3.06	77.7	.32	8.1
G25306-2020	20G-20FL45S	7103-27555	1 1/4	31.8	2.00	50.8	1.26	32.0	6.18	157.0	3.86	98.0	.32	8.1

Komatsu O-Ring Flange - 45° Bent Tube

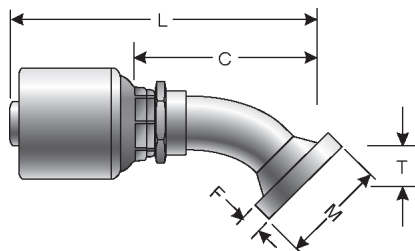

Part No.	Descr.	Prod. No.	⊖		M		T		L		C		F	
			"	mm	"	mm	"	mm	"	mm	"	mm	"	mm
G25307-1010	10G-10FLK45	7100-04155	5/8	15.9	1.35	34.3	1.02	26.0	4.19	106.5	2.72	69.0	.27	6.9

- EQUIPMENT
- HOSE/CPLG. SELECTION
- G8K COUPLINGS
- GLOBALSPIRAL COUPLINGS
- STAINLESS STEEL SPIRAL
- MEGACRIMP COUPLINGS**
- STAINLESS STEEL BRAID
- POWER CRIMP COUPLINGS
- FIELD ATTACHABLE G1 & G2 COUPLINGS
- FIELD ATTACHABLE C5 COUPLINGS
- C14 COUPLINGS
- GL COUPLINGS
- GLX COUPLINGS
- PCTS THERMOPLASTIC COUPLINGS
- POLARSEAL COUPLINGS (ACA)
- POLARSEAL II COUPLINGS (ACC)
- POLARSEAL II COUPLINGS (ACB)
- POWER STEERING
- ADAPTERS
- QUICK DISCONNECT COUPLERS
- BALL VALVES
- LIVE SWIVEL
- ASSEMBLY FABRICATION
- ACCESSORIES
- EQUIPMENT AND PARTS
- KITS
- AIR BRAKE HOSE ASSY
- BRASS

EQUIPMENT
HOSE/CPLG. SELECTION
G8K COUPLINGS
GLOBAL SPIRAL COUPLINGS
STAINLESS STEEL SPIRAL
<b>MEGACRIMP COUPLINGS</b>
STAINLESS STEEL BRAID
POWER CRIMP COUPLINGS
FIELD ATTACHABLE G1 & G2 COUPLINGS
FIELD ATTACHABLE C5 COUPLINGS
C14 COUPLINGS
GL COUPLINGS
GLX COUPLINGS
PCTS THERMOPLASTIC COUPLINGS
POLARSEAL COUPLINGS (ACA)
POLARSEAL II COUPLINGS (ACC)
POLARSEAL II COUPLINGS (ACB)
POWER STEERING
ADAPTERS
QUICK DISCONNECT COUPLERS
BALL VALVES
LIVE SWIVEL
ASSEMBLY FABRICATION
ACCESSORIES
EQUIPMENT AND PARTS
KITS
AIR BRAKE HOSE ASSY
BRASS

### Code 61 O-Ring Flange - 60° Bent Tube

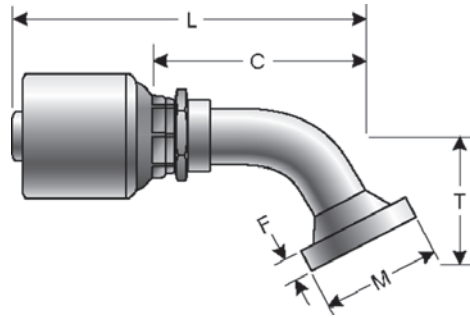

Part No.	Descr.	Prod. No.	⊖		M		T		L		C		F	
			"	mm	"	mm	"	mm	"	mm	"	mm	"	mm
G25309-1212	12G-12FL60M	7103-28155	3/4	19.1	1.50	38.1	1.46	37.0	5.04	128.0	3.03	77.0	.27	6.9
G25309-1216	12G-16FL60M	7103-28205	3/4	19.1	1.75	44.5	1.73	44.0	5.20	132.0	3.19	81.0	.32	8.1
G25309-1616	16G-16FL60M	7103-28255	1	25.4	1.75	44.5	1.73	44.0	5.85	148.5	3.61	91.7	.32	8.1
G25308-2020	20G-20FL60S	7103-28345	1 1/4	31.8	2.00	50.8	1.77	45.0	6.22	158.0	3.90	99.0	.32	8.1

### Code 61 O-Ring Flange - 67 1/2° Bent Tube

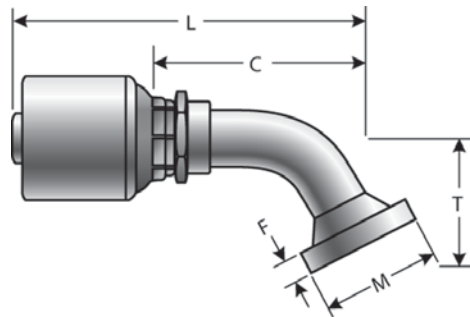

Part No.	Descr.	Prod. No.	⊖		M		T		L		C		F	
			"	mm	"	mm	"	mm	"	mm	"	mm	"	mm
G25311-1212	12G-12FL67M	7100-04355	3/4	19.1	1.50	38.1	1.65	42.0	4.65	118.0	2.64	67.0	.27	6.9
G25311-2020	20G-20FL67S	7100-04335	1 1/4	31.8	2.00	50.8	2.01	51.0	5.92	150.4	3.60	91.4	.32	8.1



### Code 61 O-Ring Flange - 90° Bent Tube

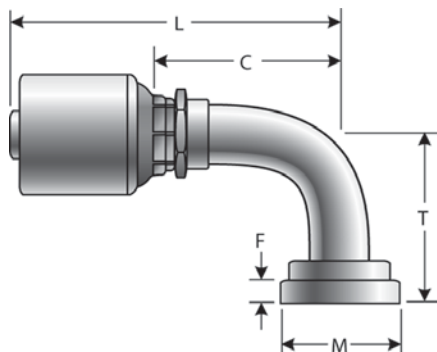

Part No.	Descr.	Prod. No.	⊖		M		T		L		C		F	
			"	mm	"	mm	"	mm	"	mm	"	mm	"	mm
G25315-0808	8G-8FL90M	7103-29115	1/2	12.7	1.19	30.2	1.57	40.0	3.59	91.2	2.11	53.7	.27	6.9
G25315-0812	8G-12FL90M	7103-29235	1/2	12.7	1.50	38.1	2.28	58.0	3.60	91.5	2.13	54.0	.27	6.9
G25315-1012	10G-12FL90M	7103-29415	5/8	15.9	1.50	38.1	2.28	58.0	3.94	100.0	2.46	62.5	.27	6.9
G25315-1212	12G-12FL90M	7103-29535	3/4	19.1	1.50	38.1	2.28	58.0	4.54	115.3	2.53	64.3	.27	6.9
G25314-1216	12G-16FL90S	7103-29585	3/4	19.1	1.75	44.5	2.40	61.0	4.72	119.8	2.71	68.8	.32	8.1
G25315-1612	16G-12FL90M	7103-29655	1	25.4	1.50	38.1	2.28	58.0	5.09	129.3	2.85	72.5	.27	6.9
G25314-1616	16G-16FL90S	7103-29705	1	25.4	1.75	44.5	2.40	61.0	5.48	139.3	3.25	82.5	.32	8.1
G25314-1620	16G-20FL90S	7103-29765	1	25.4	2.00	50.8	2.68	68.0	5.48	139.3	3.25	82.5	.32	8.1
G25314-1624	16G-24FL90S-081	7100-04555	1	25.4	2.38	60.5	3.19	81.0	5.57	141.6	3.34	84.8	.32	8.1
G25314-2020	20G-20FL90S	7103-29885	1 1/4	31.8	2.00	50.8	2.68	68.0	6.22	158.1	3.90	99.1	.32	8.1
G25315-2020	20G-20FL90M	7103-29895	1 1/4	31.8	2.00	50.8	3.54	90.0	5.31	135.0	2.99	76.0	.32	8.1
G25316-2020	20G-20FL90-102	7100-04565	1 1/4	31.8	2.00	50.8	4.00	101.6	5.43	138.0	3.11	79.0	.32	8.1
G25314-2024	20G-24FL90S	7103-29945	1 1/4	31.8	2.38	60.5	3.19	81.0	6.22	158.1	3.90	99.1	.32	8.1

### Komatsu O-Ring Flange - 90° Bent Tube

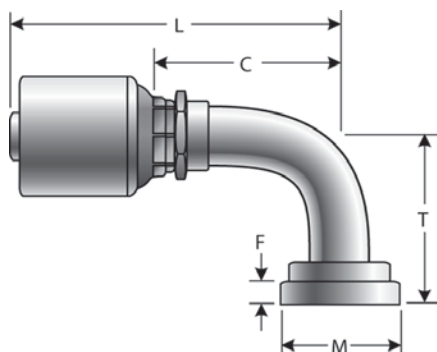

Part No.	Descr.	Prod. No.	⊖		M		T		L		C		F	
			"	mm	"	mm	"	mm	"	mm	"	mm	"	mm
G25315-1010	10G-10FLK90	7100-04475	5/8	15.9	1.35	34.3	2.17	55.0	3.90	99.0	2.42	61.5	.27	6.9

EQUIPMENT
HOSE/CPLG. SELECTION
G8K COUPLINGS
GLOBALSPIRAL COUPLINGS
STAINLESS STEEL SPIRAL
MEGACRIMP COUPLINGS
STAINLESS STEEL BRAID
POWER CRIMP COUPLINGS
FIELD ATTACHABLE G1 & G2 COUPLINGS
FIELD ATTACHABLE C5 COUPLINGS
C14 COUPLINGS
GL COUPLINGS
GLX COUPLINGS
PCTS THERMOPLASTIC COUPLINGS
POLARSEAL COUPLINGS (ACA)
POLARSEAL II COUPLINGS (ACC)
POLARSEAL II COUPLINGS (ACB)
POWER STEERING
ADAPTERS
QUICK DISCONNECT COUPLERS
BALL VALVES
LIVE SWIVEL
ASSEMBLY FABRICATION
ACCESSORIES
EQUIPMENT AND PARTS
KITS
AIR BRAKE HOSE ASSY
BRASS



EQUIPMENT
HOSE/CPLG. SELECTION
G8K COUPLINGS
GLOBALSPIRAL COUPLINGS
STAINLESS STEEL SPIRAL

### SAE Male Inverted Swivel

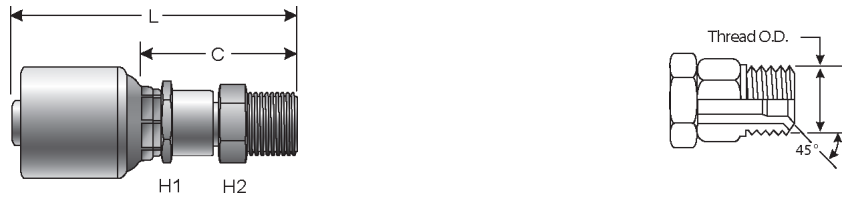

MEGACRIMP COUPLINGS
---------------------

Part No.	Descr.	Prod. No.	⌀		"	H1	H2	L		C	
			"	mm				"	"	mm	"
G25500-0403	4G-3MIX	7100-16205	1/4	6.4	3/8-24	1/2	3/8	2.52	64.0	1.50	38.0
G25500-0404	4G-4MIX	7100-16225	1/4	6.4	7/16-24	1/2	7/16	2.52	63.9	1.49	37.9
G25500-0405	4G-5MIX	7100-16235	1/4	6.4	1/2-20	1/2	1/2	2.52	63.9	1.49	37.9
G25500-0604	6G-4MIX	7100-16185	3/8	9.5	7/16-24	5/8	7/16	2.63	66.9	1.54	39.0
G25500-0605	6G-5MIX	7100-16245	3/8	9.5	1/2-20	5/8	1/2	2.56	64.9	1.46	37.0
G25500-0606	6G-6MIX	7100-16255	3/8	9.5	5/8-18	5/8	5/8	2.75	69.9	1.65	42.0
G25500-0607	6G-7MIX	7100-16265	3/8	9.5	11/16-18	5/8	11/16	2.76	70.0	1.66	42.1
G25500-0806	8G-6MIX	7100-06275	1/2	12.7	5/8-18	13/16	5/8	3.13	79.5	1.65	42.0
G25500-0808	8G-8MIX	7100-06285	1/2	12.7	3/4-18	13/16	3/4	3.30	83.8	1.82	46.3
G25500-1010	10G-10MIX	7100-06295	5/8	15.9	7/8-18	15/16	7/8	3.92	99.5	2.44	62.0

GL COUPLINGS
--------------

GLX COUPLINGS
---------------

### SAE Male Inverted Swivel - 45° Bent Tube

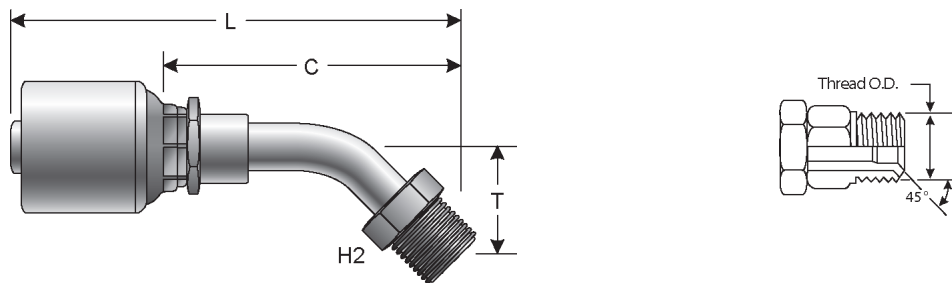

PCTS THERMOPLASTIC COUPLINGS
------------------------------

POLARSEAL COUPLINGS (ACA)
---------------------------

POLARSEAL II COUPLINGS (ACC)
------------------------------

POLARSEAL II COUPLINGS (ACB)
------------------------------

Part No.	Descr.	Prod. No.	⌀		"	H2	T		L		C	
			"	mm			"	mm	"	mm	"	mm
G25502-0403	4G-3MIX45-018	7100-16275	1/4	6.4	3/8-24	3/8	.69	17.5	2.67	67.9	1.65	41.9
G25502-0404	4G-4MIX45-024	7100-16285	1/4	6.4	7/16-24	7/16	.93	23.5	3.04	77.3	2.02	51.2
G25502-0604	6G-4MIX45	7100-16305	3/8	9.5	7/16-24	7/16	1.00	25.4	3.17	80.5	2.07	52.6
G25502-0605	6G-5MIX45	7100-16315	3/8	9.5	1/2-20	1/2	1.00	25.4	3.13	79.5	2.03	51.6
G25502-0606	6G-6MIX45	7100-16325	3/8	9.5	5/8-18	5/8	1.00	25.4	3.32	84.3	2.22	56.4
G25502-0607	6G-7MIX45	7100-16335	3/8	9.5	11/16-18	11/16	1.00	25.4	3.39	86.0	2.29	58.1
G25502-0808	8G-8MIX45	7100-16345	1/2	12.7	3/4-18	3/4	1.14	29.0	4.17	106.0	2.70	68.5
G25502-1010	10G-10MIX45	7100-16435	5/8	15.9	7/8-18	7/8	1.38	35.1	2.33	59.2	1.31	33.2

POWER STEERING
----------------

ADAPTERS
----------

QUICK DISCONNECT COUPLERS
---------------------------

BALL VALVES
-------------

LIVE SWIVEL
-------------

ASSEMBLY FABRICATION
----------------------

ACCESSORIES
-------------

EQUIPMENT AND PARTS
---------------------

KITS
------

AIR BRAKE HOSE ASSY
---------------------

BRASS
-------



### SAE Male Inverted Swivel - 90° Bent Tube

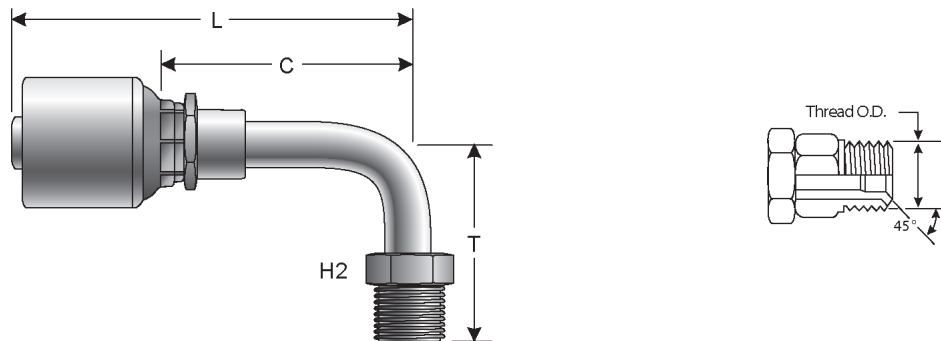

Part No.	Descr.	Prod. No.	⌀		H2	T		L		C		
			"	mm		"	mm	"	mm	"	mm	
G25504-0404	4G-4MIX90	7100-16355	1/4	6.4	7/16-24	7/16	1.38	35.1	2.33	59.2	1.31	33.2
G25504-0405	4G-5MIX90	7100-16365	1/4	6.4	1/2-20	1/2	1.38	35.1	2.46	62.5	1.44	36.5
G25504-0506	5G-6MIX90-035	7100-16385	5/16	7.9	5/8-18	5/8	1.38	35.1	2.78	70.5	1.67	42.5
G25504-0604	6G-4MIX90	7100-16395	3/8	9.5	7/16-24	7/16	1.38	35.1	2.44	62.0	1.34	34.1
G25504-0605	6G-5MIX90	7100-16405	3/8	9.5	1/2-20	1/2	1.38	35.1	2.50	63.5	1.40	35.6
G25504-0606	6G-6MIX90	7100-16415	3/8	9.5	5/8-18	5/8	1.38	35.1	2.80	71.0	1.70	43.1
G25504-0607	6G-7MIX90	7100-16425	3/8	9.5	11/16-18	11/16	1.38	35.1	2.80	71.0	1.70	43.1
G25504-0808	8G-8MIX90	7100-06435	1/2	12.7	3/4-18	3/4	1.64	41.7	3.29	83.5	1.81	46.0
G25504-1010	10G-10MIX90	7100-06335	5/8	15.9	7/8-18	7/8	1.81	46.0	3.89	98.7	2.41	61.3

### SAE Male Flareless Assembly

See Accessories for Individual Sleeves and Nuts.

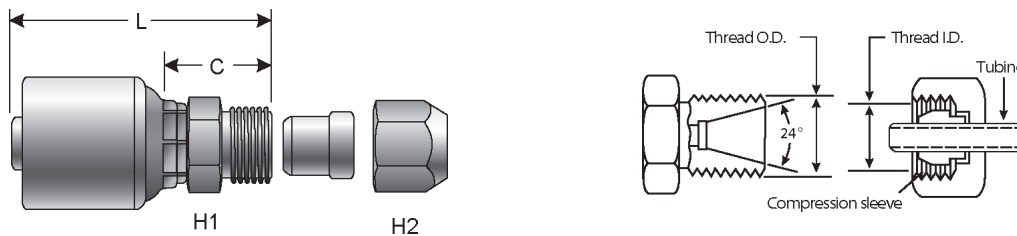

Part No.	Descr.	Prod. No.	⌀		H1	H2	L		C		
			"	mm			"	mm	"	mm	
G25510-0404	4G-4MFA	7100-16445	1/4	6.4	7/16-20	1/2	9/16	2.09	53.0	1.06	27.0
G25510-0405	4G-5MFA	7100-16455	1/4	6.4	1/2-20	1/2	5/8	1.97	50.0	.94	24.0
G25510-0505	5G-5MFA	7100-16515	5/16	7.9	1/2-20	5/8	5/8	2.13	54.0	1.02	26.0
G25510-0506	5G-6MFA	7100-16505	5/16	7.9	9/16-18	5/8	11/16	2.21	56.1	1.11	28.1
G25510-0604	6G-4MFA	7100-16465	3/8	9.5	7/16-20	5/8	9/16	2.17	55.0	1.07	27.1
G25510-0605	6G-5MFA	7100-16475	3/8	9.5	1/2-20	5/8	5/8	2.17	55.0	1.07	27.1
G25510-0606	6G-6MFA	7100-16485	3/8	9.5	9/16-18	5/8	11/16	2.20	56.0	1.11	28.1
G25510-0608	6G-8MFA	7100-16495	3/8	9.5	3/4-16	3/4	7/8	2.40	61.0	1.30	33.1
G25510-0808	8G-8MFA	7100-06505	1/2	12.7	3/4-16	13/16	7/8	2.78	70.5	1.30	33.0
G25510-0810	8G-10MFA	7100-06515	1/2	12.7	7/8-14	7/8	1	2.83	72.0	1.36	34.5
G25510-1212	12G-12MFA	7100-06525	3/4	19.1	1 1/16-12	1 1/16	1 1/4	3.54	90.0	1.54	39.0
G25510-1616	16G-16MFA	7100-06535	1	25.4	1 5/16-12	1 3/8	1 1/2	3.94	100.0	1.70	43.2

- EQUIPMENT
- HOSE/CPLG. SELECTION
- G8K COUPLINGS
- GLOBALSPIRAL COUPLINGS
- STAINLESS STEEL SPIRAL
- MEGACRIMP COUPLINGS
- STAINLESS STEEL BRAID
- POWER CRIMP COUPLINGS
- FIELD ATTACHABLE G1 & G2 COUPLINGS
- FIELD ATTACHABLE C5 COUPLINGS
- C14 COUPLINGS
- GL COUPLINGS
- GLX COUPLINGS
- PCTS THERMOPLASTIC COUPLINGS
- POLARSEAL COUPLINGS (ACA)
- POLARSEAL II COUPLINGS (ACC)
- POLARSEAL II COUPLINGS (ACB)
- POWER STEERING
- ADAPTERS
- QUICK DISCONNECT COUPLERS
- BALL VALVES
- LIVE SWIVEL
- ASSEMBLY FABRICATION
- ACCESSORIES
- EQUIPMENT AND PARTS
- KITS
- AIR BRAKE HOSE ASSY
- BRASS



EQUIPMENT
HOSE/CPLG. SELECTION
G8K COUPLINGS
GLOBALSPIRAL COUPLINGS
STAINLESS STEEL SPIRAL
<b>MEGACRIMP COUPLINGS</b>
STAINLESS STEEL BRAID
POWER CRIMP COUPLINGS
FIELD ATTACHABLE G1 & G2 COUPLINGS
FIELD ATTACHABLE C5 COUPLINGS
C14 COUPLINGS
GL COUPLINGS
GLX COUPLINGS
PCTS THERMOPLASTIC COUPLINGS
POLARSEAL COUPLINGS (ACA)
POLARSEAL II COUPLINGS (ACC)
POLARSEAL II COUPLINGS (ACB)
POWER STEERING
ADAPTERS
QUICK DISCONNECT COUPLERS
BALL VALVES
LIVE SWIVEL
ASSEMBLY FABRICATION
ACCESSORIES
EQUIPMENT AND PARTS
KITS
AIR BRAKE HOSE ASSY
BRASS

### North American Stand Pipe

See Accessories for Individual Sleeves and Nuts.

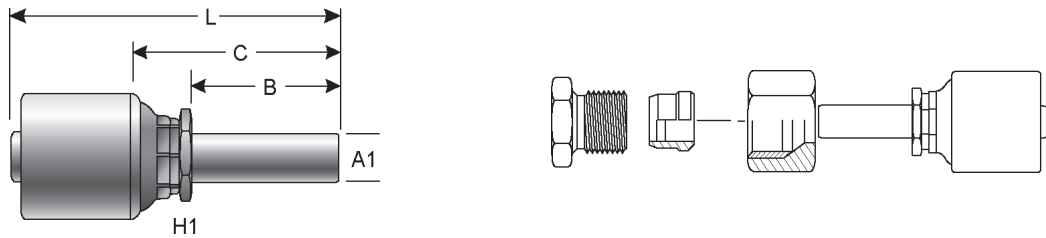

Part No.	Descr.	Prod. No.	⊖		H1	L		C		B		A1
			"	mm		"	mm	"	mm	"	mm	
G25520-0404	4G-4NASP	7100-08305	1/4	6.4	1/2	2.26	57.5	1.24	31.5	.88	22.4	1/4
G25520-0606	6G-6NASP	7100-08335	3/8	9.5	5/8	2.34	59.5	1.24	31.6	.88	22.4	3/8
G25520-0808	8G-8NASP	7100-08365	1/2	12.7	13/16	2.87	73.0	1.40	35.5	1.00	25.4	1/2
G25520-1212	12G-12NASP	7100-08435	3/4	19.1	1 1/16	3.58	91.0	1.57	40.0	1.16	29.5	3/4
G25520-1616	16G-16NASP	7100-08465	1	25.4	1 7/16	3.86	98.0	1.62	41.2	1.12	28.4	1

### Hose Length Extender

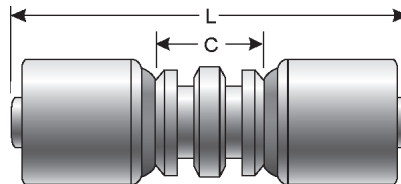

Part No.	Descr.	Prod. No.	⊖		L		C	
			"	mm	"	mm	"	mm
G25535-2020	20G-20HLE	7101-50705	1 1/4	31.8	5.96	151.5	1.32	33.5

### Female Air Brake Swivel

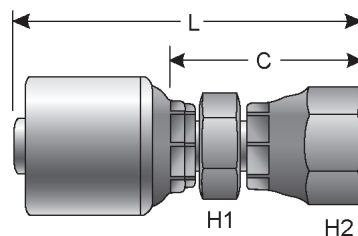

Part No.	Descr.	Prod. No.	⊖		🌀	H1	H2	L		C	
			"	mm				"	mm	"	mm
G25540-0606	6G-6FABX	7100-13095	3/8	9.5	3/4-20	3/4	7/8	2.41	61.2	1.31	33.3
G25540-0806	8G-6FABX	7100-13105	1/2	12.7	3/4-20	13/16	7/8	2.74	69.7	1.27	32.2
G25540-0808	8G-8FABX	7100-13125	1/2	12.7	7/8-20	13/16	1 1/16	3.02	76.7	1.54	39.2





### Female Grease

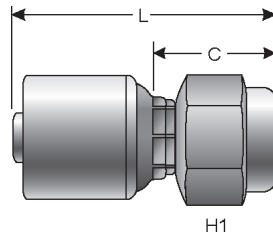

Part No.	Descr.	Prod. No.	⊖		🌀	H1	L		C	
			"	mm			"	mm	"	mm
G25561-0408	4G-8FG	7100-09605	1/4	6.4	1/2-27	11/16	1.87	47.5	.85	21.5
G25561-0608	6G-8FG	7100-09615	3/8	9.5	1/2-27	11/16	1.93	49.0	.83	21.2

### Female Parker Triple Thread Flare

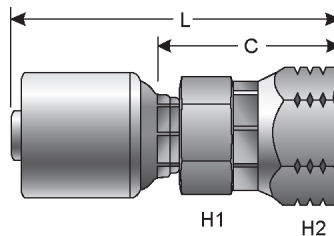

Part No.	Descr.	Prod. No.	⊖		🌀	H1	H2	L		C	
			"	mm				"	mm	"	mm
G25562-1616	16G-16FZX	7100-00015	1	25.4	1 5/16-14	1 3/8	1 1/2	3.98	101.0	1.74	44.3

### Pressure Wash Swivel

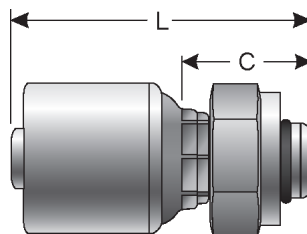

Part No.	Descr.	Prod. No.	⊖		🌀	L		C	
			"	mm		"	mm	"	mm
G25563-0406	4G-6PWX	7100-02905	1/4	6.4	M22X1.5	2.52	64.0	1.50	38.0
G25563-0606	6G-6PWX	7100-02915	3/8	9.5	M22X1.5	2.60	66.0	1.50	38.1

EQUIPMENT
HOSE/CPLG. SELECTION
G8K COUPLINGS
GLOBALSPIRAL COUPLINGS
STAINLESS STEEL SPIRAL
<b>MEGACRIMP COUPLINGS</b>
STAINLESS STEEL BRAID
POWER CRIMP COUPLINGS
FIELD ATTACHABLE G1 & G2 COUPLINGS
FIELD ATTACHABLE C5 COUPLINGS
C14 COUPLINGS
GL COUPLINGS
GLX COUPLINGS
PCTS THERMOPLASTIC COUPLINGS
POLARSEAL COUPLINGS (ACA)
POLARSEAL II COUPLINGS (ACC)
POLARSEAL II COUPLINGS (ACB)
POWER STEERING
ADAPTERS
QUICK DISCONNECT COUPLERS
BALL VALVES
LIVE SWIVEL
ASSEMBLY FABRICATION
ACCESSORIES
EQUIPMENT AND PARTS
KITS
AIR BRAKE HOSE ASSY
BRASS

EQUIPMENT
HOSE/CPLG. SELECTION
G8K COUPLINGS
GLOBALSPIRAL COUPLINGS
STAINLESS STEEL SPIRAL
<b>MEGACRIMP COUPLINGS</b>
STAINLESS STEEL BRAID
POWER CRIMP COUPLINGS
FIELD ATTACHABLE G1 & G2 COUPLINGS
FIELD ATTACHABLE C5 COUPLINGS
C14 COUPLINGS
GL COUPLINGS
GLX COUPLINGS
PCTS THERMOPLASTIC COUPLINGS
POLARSEAL COUPLINGS (ACA)
POLARSEAL II COUPLINGS (ACC)
POLARSEAL II COUPLINGS (ACB)
POWER STEERING
ADAPTERS
QUICK DISCONNECT COUPLERS
BALL VALVES
LIVE SWIVEL
ASSEMBLY FABRICATION
ACCESSORIES
EQUIPMENT AND PARTS
KITS
AIR BRAKE HOSE ASSY
BRASS

### US Banjo

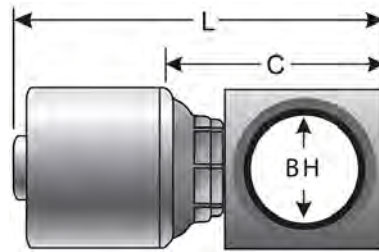

Part No.	Descr.	Prod. No.	⊖		L		C		BH
			"	mm	"	mm	"	mm	mm
G25564-0606	6G-6BJ	7100-02945	3/4	19.1	2.28	57.9	.74	18.8	3/8

### Male DIN 24° Cone - Light Series

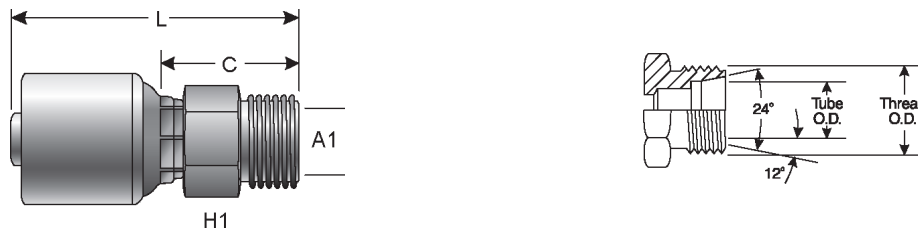

Part No.	Descr.	Prod. No.	⊖		H1	L		C		A1	
			"	mm		"	mm	"	mm	mm	
G25615-0406	4G-6MDL	7100-92685	1/4	6.4	M12X1.5	14	1.69	42.9	.78	19.8	6.0
G25615-0408	4G-8MDL	7100-14835	1/4	6.4	M14X1.5	17	1.97	50.0	.94	24.0	8.0
G25615-0410	4G-10MDL	7100-14845	1/4	6.4	M16X1.5	17	2.01	51.0	.98	25.0	10.0
G25615-0610	6G-10MDL	7100-14865	3/8	9.5	M16X1.5	17	2.07	52.5	.97	24.6	10.0
G25615-0612	6G-12MDL	7100-14875	3/8	9.5	M18X1.5	19	2.07	52.5	.97	24.6	12.0
G25615-0615	6G-15MDL	7100-92695	3/8	9.5	M22X1.5	24	1.86	47.3	.94	23.9	15.0
G25615-0815	8G-15MDL	7100-04885	1/2	12.7	M22X1.5	24	2.56	65.0	1.08	27.5	15.0
G25615-1018	10G-18MDL	7100-99685	5/8	15.9	M26X1.5	27	2.52	64.0	1.04	26.5	18.0
G25615-1022	10G-22MDL	7100-04935	5/8	15.9	M30X2.0	32	2.75	69.8	1.27	32.3	22.0
G25615-1218	12G-18MDL	7100-25085	3/4	19.1	M26X1.5	27	3.07	78.0	1.06	27.0	18.0
G25615-1222	12G-22MDL	7100-25075	3/4	19.1	M30X2.0	32	3.15	80.0	1.14	29.0	22.0
G25615-1628	16G-28MDL	7100-04915	1	25.4	M36X2.0	41	3.70	94.0	1.46	37.2	28.0
G25615-2035	20G-35MDL	7100-04925	1 1/4	31.8	M45X2.0	46	3.92	99.5	1.59	40.5	35.0



## Female DIN 24° Cone Swivel - Light Series with O-Ring

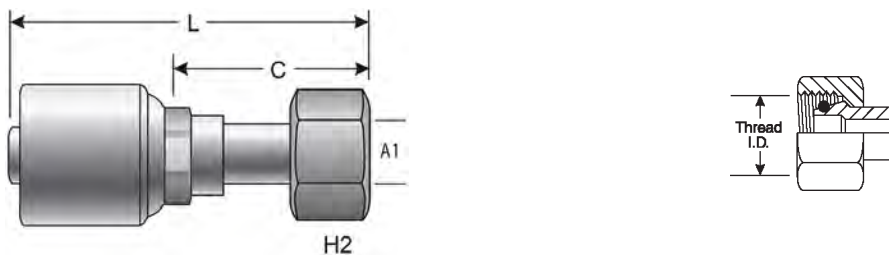

Part No.	Descr.	Prod. No.	⊖		H2	L		C		A1	
			"	mm		"	mm	"	mm		
G25645-0406	4G-6FDLORX	7100-95665	1/4	6.4	M12X1.5	14	2.04	51.8	1.13	28.8	6.0
G25645-0408	4G-8FDLORX	7100-95685	1/4	6.4	M14X1.5	17	2.19	55.7	1.17	29.7	8.0
G25645-0410	4G-10FDLORX	7100-95705	1/4	6.4	M16X1.5	19	2.18	55.3	1.15	29.3	10.0
G25645-0412	4G-12FDLORX	7100-25395	1/4	6.4	M18X1.5	22	2.19	55.7	1.17	29.7	12.0
G25645-0510	5G-10FDLORX	7100-92015	5/16	7.9	M16X1.5	19	2.12	53.9	1.17	29.7	10.0
G25645-0512	5G-12FDLORX	7100-92035	5/16	7.9	M18X1.5	22	2.30	58.5	1.18	30.0	12.0
G25645-0610	6G-10FDLORX	7100-96065	3/8	9.5	M16X1.5	19	2.25	57.1	1.07	27.1	10.0
G25645-0612	6G-12FDLORX	7100-96085	3/8	9.5	M18X1.5	22	2.19	55.5	1.09	27.7	12.0
G25645-0614	6G-14FDLORX	7100-96105	3/8	9.5	M20X1.5	24	2.38	60.4	1.85	30.1	14.0
G25645-0615	6G-15FDLORX	7100-96115	3/8	9.5	M22X1.5	27	2.23	56.7	1.03	26.1	15.0
G25645-0815	8G-15FDLORX	7100-25445	1/2	12.7	M22X1.5	27	2.64	67.0	1.16	29.5	15.0
G25645-0818	8G-18FDLORX	7100-96445	1/2	12.7	M26X1.5	32	2.67	67.9	1.08	27.5	18.0
G25645-1018	10G-18FDLORX	7100-99535	5/8	15.9	M26X1.5	32	2.67	67.8	1.16	29.5	18.0
G25645-1218	12G-18FDLORX	7100-99935	3/4	19.1	M26X1.5	32	3.30	83.8	1.20	30.5	18.0
G25645-1222	12G-22FDLORX	7100-99955	3/4	19.1	M30X2.0	36	3.38	85.8	1.28	32.5	22.0
G25645-1628	16G-28FDLORX	7100-92205	1	25.4	M36X2.0	41	3.21	81.6	1.45	36.7	28.0
G25645-2035	20G-35FDLORX	7100-92215	1 1/4	31.8	M45X2.0	50	3.56	90.4	1.74	44.1	35.0
G25645-2042	20G-42FDLORX	7100-95305	1 1/4	31.8	M52X2.0	60	4.25	108.0	1.93	49.0	42.0

## Female DIN 24° Cone Swivel - Light Series with O-Ring - 45° Bent Tube

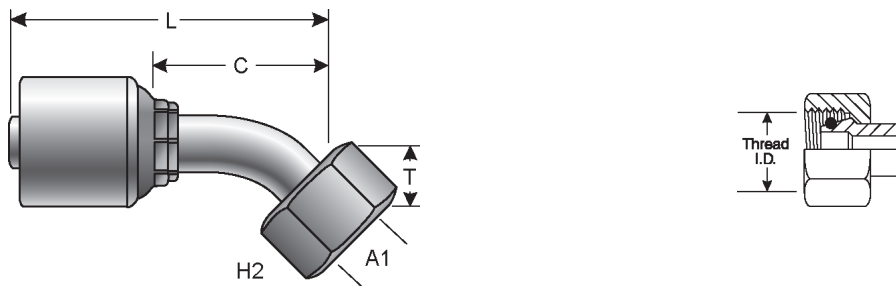

Part No.	Descr.	Prod. No.	⊖		H2	T		L		C		A1	
			"	mm		"	mm	"	mm	"	mm		
G25650-0408	4G-8FDLORX45	7100-95755	1/4	6.4	M14X1.5	19	.64	16.2	2.46	62.6	1.44	36.5	8.0
G25650-0410	4G-10FDLORX45	7100-95775	1/4	6.4	M16X1.5	19	.70	17.9	2.54	64.4	1.51	38.3	10.0
G25650-0510	5G-10FDLORX45	7100-91895	5/16	7.9	M16X1.5	19	.67	17.0	2.50	63.4	1.55	39.3	10.0
G25650-0610	6G-10FDLORX45	7100-96135	3/8	9.5	M16X1.5	19	.73	18.6	2.67	68.5	1.59	40.5	10.0
G25650-0612	6G-12FDLORX45	7100-96155	3/8	9.5	M18X1.5	22	.74	18.9	2.71	68.8	1.61	40.9	12.0
G25650-0615	6G-15FDLORX45	7100-96175	3/8	9.5	M22X1.5	27	.89	22.5	2.85	72.3	1.75	44.4	15.0
G25650-0815	8G-15FDLORX45	7100-96475	1/2	12.7	M22X1.5	27	.80	20.2	3.33	84.6	1.85	47.0	15.0

EQUIPMENT
HOSE/CPLG. SELECTION
G8K COUPLINGS
GLOBALSPIRAL COUPLINGS
STAINLESS STEEL SPIRAL
<b>MEGACRIMP COUPLINGS</b>
STAINLESS STEEL BRAID
POWER CRIMP COUPLINGS
FIELD ATTACHABLE G1 & G2 COUPLINGS
FIELD ATTACHABLE C5 COUPLINGS
C14 COUPLINGS
GL COUPLINGS
GLX COUPLINGS
PCTS THERMOPLASTIC COUPLINGS
POLARSEAL COUPLINGS (ACA)
POLARSEAL II COUPLINGS (ACC)
POLARSEAL II COUPLINGS (ACB)
POWER STEERING
ADAPTERS
QUICK DISCONNECT COUPLERS
BALL VALVES
LIVE SWIVEL
ASSEMBLY FABRICATION
ACCESSORIES
EQUIPMENT AND PARTS
KITS
AIR BRAKE HOSE ASSY
BRASS



EQUIPMENT
HOSE/CPLG. SELECTION
G8K COUPLINGS
GLOBAL SPIRAL COUPLINGS
STAINLESS STEEL SPIRAL
MEGACRIMP COUPLINGS
STAINLESS STEEL BRAID
POWER CRIMP COUPLINGS
FIELD ATTACHABLE G1 & G2 COUPLINGS
FIELD ATTACHABLE C5 COUPLINGS
C14 COUPLINGS
GL COUPLINGS
GLX COUPLINGS
PCTS THERMOPLASTIC COUPLINGS
POLARSEAL COUPLINGS (ACA)
POLARSEAL II COUPLINGS (ACC)
POLARSEAL II COUPLINGS (ACB)
POWER STEERING
ADAPTERS
QUICK DISCONNECT COUPLERS
BALL VALVES
LIVE SWIVEL
ASSEMBLY FABRICATION
ACCESSORIES
EQUIPMENT AND PARTS
KITS
AIR BRAKE HOSE ASSY
BRASS

Female DIN 24° Cone Swivel - Light Series with O-Ring - 45° Bent Tube - Continued

Part No.	Descr.	Prod. No.	⊖		H2	T		L		C		A1	
			"	mm		"	mm	"	mm	"	mm		
G25650-0818	8G-18FDLORX45	7100-96495	1/2	12.7	M26X1.5	32	1.06	26.9	3.74	94.9	2.25	57.2	18.0
G25650-1018	10G-18FDLORX45	7100-99545	5/8	15.9	M26X1.5	32	.98	24.8	3.68	93.5	2.21	56.2	18.0
G25650-1222	12G-22FDLORX45	7100-96715	3/4	19.1	M30X2.0	36	1.17	29.8	4.12	104.6	2.60	66.1	22.0
G25650-1628	16G-28FDLORX45	7100-92325	1	25.4	M36X2.0	41	1.21	30.9	4.87	123.7	3.10	78.8	28.0
G25650-2035	20G-35FDLORX45	7100-92335	1 1/4	31.8	M45X2.0	50	1.48	37.5	5.48	139.3	3.68	93.4	35.0

Female DIN 24° Cone Swivel - Light Series with O-Ring - 90° Bent Tube

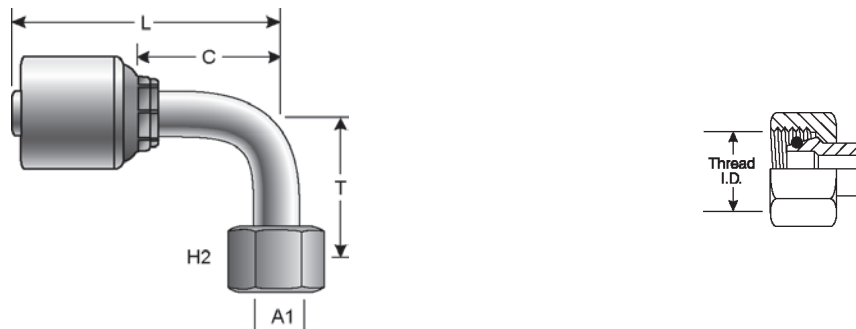

Part No.	Descr.	Prod. No.	⊖		H2	T		L		C		A1	
			"	mm		"	mm	"	mm	"	mm		
G25655-0406	4G-6FDLORX90	7100-95825	1/4	6.4	M12X1.5	14	1.38	35.0	2.27	57.6	1.24	31.5	6.0
G25655-0408	4G-8FDLORX90	7100-95845	1/4	6.4	M14X1.5	17	1.38	35.0	2.36	60.0	1.34	34.0	8.0
G25655-0410	4G-10FDLORX90	7100-95865	1/4	6.4	M16X1.5	19	1.44	36.5	2.27	57.6	1.24	31.5	10.0
G25655-0510	5G-10FDLORX90	7100-91725	5/16	7.9	M16X1.5	19	1.44	36.5	2.31	58.6	1.35	34.4	10.0
G25655-0610	6G-10FDLORX90	7100-96195	3/8	9.5	M16X1.5	19	1.44	36.5	2.37	60.2	1.27	32.3	10.0
G25655-0612	6G-12FDLORX90	7100-96215	3/8	9.5	M18X1.5	22	1.46	37.0	2.37	60.1	1.27	32.2	12.0
G25655-0615	6G-15FDLORX90	7100-96235	3/8	9.5	M22X1.5	27	1.65	42.0	2.37	60.1	1.27	32.2	15.0
G25655-0815	8G-15FDLORX90	7100-96505	1/2	12.7	M22X1.5	27	1.65	42.0	3.06	77.8	1.59	40.3	15.0
G25655-0818	8G-18FDLORX90	7100-96525	1/2	12.7	M26X1.5	32	2.03	51.6	3.21	81.5	1.73	43.9	18.0
G25655-1018	10G-18FDLORX90	7100-99555	5/8	15.9	M26X1.5	32	2.03	51.5	3.35	85.1	1.88	47.8	18.0
G25655-1218	12G-18FDLORX90	7100-96735	3/4	19.1	M26X1.5	32	2.03	51.5	3.95	100.3	1.94	49.3	18.0
G25655-1222	12G-22FDLORX90	7100-96755	3/4	19.1	M30X2.0	36	2.44	62.0	4.22	107.3	2.22	56.3	22.0
G25655-1628	16G-28FDLORX90	7100-92445	1	25.4	M36X2.0	41	2.76	70.0	4.69	119.2	2.93	74.3	28.0
G25655-2035	20G-35FDLORX90	7100-92455	1 1/4	31.8	M45X2.0	50	3.15	80.0	5.07	128.8	3.26	82.8	35.0



### Female French GAZ Swivel

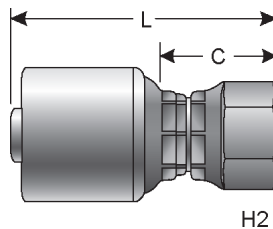

H2

Part No.	Descr.	Prod. No.	⊖		H2	L		C		
			"	mm		"	mm	"	mm	
G25680-0817	8G-17FFGX	7100-96655	1/2	12.7	M24X1.5	30	2.40	61.0	.93	23.5
G25680-1021	10G-21FFGX	7100-99595	5/8	15.9	M30X1.5	36	2.34	59.5	.87	22.0
G25680-1227	12G-27FFGX	7100-25045	3/4	19.1	M36X1.5	46	2.91	74.0	.91	23.0

### Male DIN 24° Cone - Heavy Series

See Accessories for Metric Bite Sleeves and Nuts.

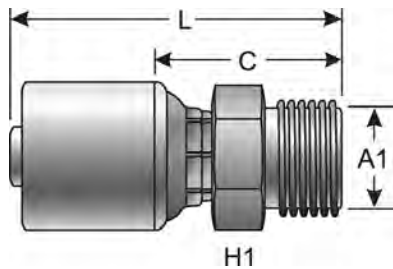

H1

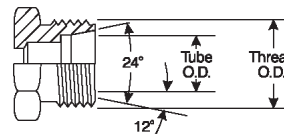

Part No.	Descr.	Prod. No.	⊖		H1	L		C		A1	
			"	mm		"	mm	"	mm		
G25715-0408	4G-8MDH	7100-15315	1/4	6.4	M16X1.5	17	2.09	53.0	1.06	27.0	8.0
G25715-0410	4G-10MDH	7100-15325	1/4	6.4	M18X1.5	19	2.07	52.5	1.04	26.5	10.0
G25715-0512	5G-12MDH	7100-93015	5/16	7.9	M20X1.5	22	2.04	51.9	1.09	27.8	12.0
G25715-0610	6G-10MDH	7100-15345	3/8	9.5	M18X1.5	19	2.17	55.0	1.07	27.1	10.0
G25715-0612	6G-12MDH	7100-15355	3/8	9.5	M20X1.5	24	2.26	57.5	1.17	29.6	12.0
G25715-0614	6G-14MDH	7100-15365	3/8	9.5	M22X1.5	24	2.34	59.5	1.24	31.6	14.0
G25715-0812	8G-12MDH	7100-94815	1/2	12.7	M20X1.5	24	2.42	61.5	1.14	29.0	12.0
G25715-0816	8G-16MDH	7100-05375	1/2	12.7	M24X1.5	27	2.72	69.0	1.24	31.5	16.0
G25715-1020	10G-20MDH	7100-99675	5/8	15.9	M30X2.0	32	2.87	73.0	1.40	35.5	20.0
G25715-1220	12G-20MDH	7100-25055	3/4	19.1	M30X2.0	32	3.43	87.0	1.42	36.0	20.0
G25715-1225	12G-25MDH	7100-25065	3/4	19.1	M36X2.0	41	3.58	91.0	1.58	40.0	25.0
G25715-1630	16G-30MDH	7100-92535	1	25.4	M42X2.0	46	3.48	88.3	1.67	42.4	30.0
G25715-2038	20G-38MDH	7100-92545	1 1/4	31.8	M52X2.0	55	3.72	94.4	1.93	49.1	38.0

EQUIPMENT
HOSE/CPLG. SELECTION
G8K COUPLINGS
GLOBALSPIRAL COUPLINGS
STAINLESS STEEL SPIRAL
MEGACRIMP COUPLINGS
STAINLESS STEEL BRAID
POWER CRIMP COUPLINGS
FIELD ATTACHABLE G1 & G2 COUPLINGS
FIELD ATTACHABLE C5 COUPLINGS
C14 COUPLINGS
GL COUPLINGS
GLX COUPLINGS
PCTS THERMOPLASTIC COUPLINGS
POLARSEAL COUPLINGS (ACA)
POLARSEAL II COUPLINGS (ACC)
POLARSEAL II COUPLINGS (ACB)
POWER STEERING
ADAPTERS
QUICK DISCONNECT COUPLERS
BALL VALVES
LIVE SWIVEL
ASSEMBLY FABRICATION
ACCESSORIES
EQUIPMENT AND PARTS
KITS
AIR BRAKE HOSE ASSY
BRASS



EQUIPMENT
HOSE/CPLG. SELECTION
G8K COUPLINGS
GLOBALSPIRAL COUPLINGS
STAINLESS STEEL SPIRAL
<b>MEGACRIMP COUPLINGS</b>
STAINLESS STEEL BRAID
POWER CRIMP COUPLINGS
FIELD ATTACHABLE G1 & G2 COUPLINGS
FIELD ATTACHABLE C5 COUPLINGS
C14 COUPLINGS
GL COUPLINGS
GLX COUPLINGS
PCTS THERMOPLASTIC COUPLINGS
POLARSEAL COUPLINGS (ACA)
POLARSEAL II COUPLINGS (ACC)
POLARSEAL II COUPLINGS (ACB)
POWER STEERING
ADAPTERS
QUICK DISCONNECT COUPLERS
BALL VALVES
LIVE SWIVEL
ASSEMBLY FABRICATION
ACCESSORIES
EQUIPMENT AND PARTS
KITS
AIR BRAKE HOSE ASSY
BRASS

## Female DIN 24° Cone Swivel - Heavy Series with O-Ring

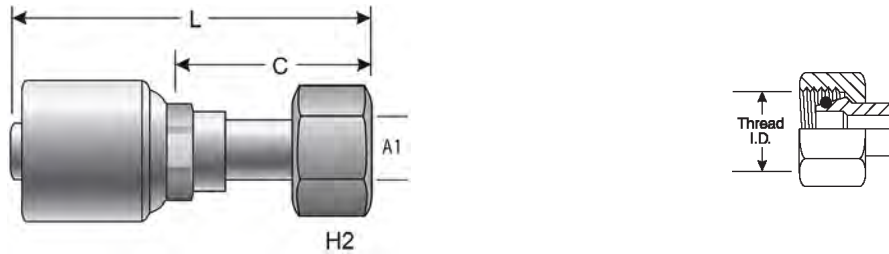

Part No.	Descr.	Prod. No.	⌀		H2	L		C		A1	
			"	mm		"	mm	"	mm		"
G25720-0408	4G-8FDHORX	7100-95675	1/4	6.4	M16X1.5	19	2.14	54.4	1.12	28.4	8.0
G25720-0410	4G-10FDHORX	7100-95695	1/4	6.4	M18X1.5	22	2.18	55.3	1.15	29.3	10.0
G25720-0412	4G-12FDHORX	7100-25405	1/4	6.4	M20X1.5	24	2.19	55.7	1.17	29.7	12.0
G25720-0512	5G-12FDHORX	7100-92045	5/16	7.9	M20X1.5	24	2.28	58.0	1.18	30.0	12.0
G25720-0514	5G-14FDHORX	7100-94835	5/16	7.9	M22X1.5	27	2.11	53.6	1.18	30.0	14.0
G25720-0610	6G-10FDHORX	7100-96055	3/8	9.5	M18X1.5	22	2.17	55.0	1.07	27.1	10.0
G25720-0612	6G-12FDHORX	7100-96075	3/8	9.5	M20X1.5	24	2.19	55.5	1.09	27.6	12.0
G25720-0614	6G-14FDHORX	7100-96095	3/8	9.5	M22X1.5	27	2.28	58.0	1.85	30.1	14.0
G25720-0812	8G-12FDHORX	7100-93335	1/2	12.7	M20X1.5	24	2.76	70.2	1.29	32.7	12.0
G25720-0814	8G-14FDHORX	7100-96415	1/2	12.7	M22X1.5	27	2.68	68.0	1.20	30.5	14.0
G25720-0816	8G-16FDHORX	7100-96435	1/2	12.7	M24X1.5	30	2.61	66.4	1.32	33.5	16.0
G25720-0820	8G-20FDHORX	7100-96455	1/2	12.7	M30X2.0	36	2.79	70.9	1.50	38.1	20.0
G25720-1016	10G-16FDHORX	7100-99525	5/8	15.9	M24X1.5	30	2.80	71.0	1.32	33.5	16.0
G25720-1020	10G-20FDHORX	7100-99565	5/8	15.9	M30X2.0	36	2.87	73.0	1.40	35.5	20.0
G25720-1220	12G-20FDHORX	7100-99945	3/4	19.1	M30X2.0	36	3.52	89.5	1.52	38.5	20.0
G25720-1225	12G-25FDHORX	7100-99965	3/4	19.1	M36X2.0	46	3.54	90.0	1.54	39.0	25.0
G25720-1625	16G-25FDHORX	7100-93215	1	25.4	M36X2.0	46	4.04	102.5	1.80	45.7	25.0
G25720-1630	16G-30FDHORX	7100-92235	1	25.4	M42X2.0	50	3.70	94.1	1.94	49.2	30.0
G25720-2038	20G-38FDHORX	7100-92245	1 1/4	31.8	M52X2.0	60	4.10	104.1	2.28	57.8	38.0

## Female DIN 24° Cone Swivel - Heavy Series with O-Ring - 45° Bent Tube

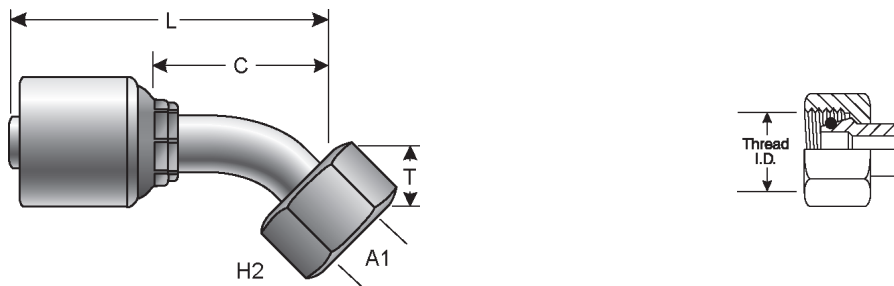

Part No.	Descr.	Prod. No.	⌀		H2	T		L		C		A1	
			"	mm		"	mm	"	mm	"	mm		"
G25725-0408	4G-8FDHORX45	7100-95745	1/4	6.4	M16X1.5	19	.64	16.2	2.46	62.6	1.44	36.5	8.0
G25725-0410	4G-10FDHORX45	7100-95765	1/4	6.4	M18X1.5	22	.70	17.9	2.54	64.4	1.51	38.3	10.0
G25725-0610	6G-10FDHORX45	7100-96125	3/8	9.5	M18X1.5	22	.73	18.6	2.70	68.5	1.59	40.5	10.0
G25725-0612	6G-12FDHORX45	7100-96145	3/8	9.5	M20X1.5	24	.74	18.9	2.71	68.8	1.61	40.9	12.0
G25725-0614	6G-14FDHORX45	7100-96165	3/8	9.5	M22X1.5	27	.83	21.0	2.79	70.9	1.69	43.0	14.0
G25725-0814	8G-14FDHORX45	7100-96465	1/2	12.7	M22X1.5	27	1.07	27.1	3.59	91.3	2.12	53.9	14.0



Female DIN 24° Cone Swivel - Heavy Series with O-Ring - 45° Bent Tube - Continued

Part No.	Descr.	Prod. No.	⊖		H2	T		L		C		A1	
			"	mm		"	mm	"	mm	"	mm		
G25725-0816	8G-16FDHORX45	7100-96485	1/2	12.7	M24X1.5	30	.85	21.6	3.38	85.9	1.91	48.4	16.0
G25725-1020	10G-20FDHORX45	7100-99575	5/8	15.9	M30X2.0	36	.98	24.9	3.67	93.1	2.20	55.8	20.0
G25725-1220	12G-20FDHORX45	7100-96705	3/4	19.1	M30X2.0	36	.98	24.9	4.31	109.4	2.30	58.4	20.0
G25725-1225	12G-25FDHORX45	7100-96725	3/4	19.1	M36X2.0	46	1.23	31.2	4.67	118.6	2.66	67.6	25.0

Female DIN 24° Cone Swivel - Heavy Series with O-Ring - 90° Bent Tube

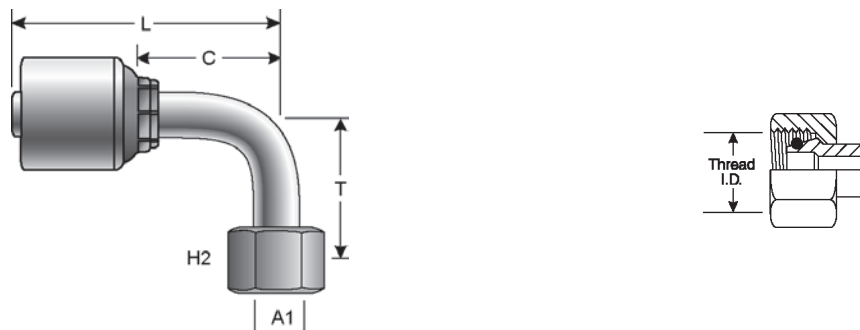

Part No.	Descr.	Prod. No.	⊖		H2	T		L		C		A1	
			"	mm		"	mm	"	mm	"	mm		
G25730-0408	4G-8FDHORX90	7100-95835	1/4	6.4	M16X1.5	19	1.38	35.0	2.36	60.0	1.34	34.0	8.0
G25730-0410	4G-10FDHORX90	7100-95855	1/4	6.4	M18X1.5	22	1.44	36.5	2.27	57.6	1.24	31.5	10.0
G25730-0512	5G-12FDHORX90	7100-91755	5/16	7.9	M20X1.5	24	1.46	37.0	2.32	59.0	1.22	31.0	12.0
G25730-0514	5G-14FDHORX90	7100-94845	5/16	7.9	M22X1.5	27	1.57	40.0	2.15	54.6	1.22	31.0	14.0
G25730-0610	6G-10FDHORX90	7100-96185	3/8	9.5	M18X1.5	22	1.44	36.5	2.37	60.1	1.27	32.2	10.0
G25730-0612	6G-12FDHORX90	7100-96205	3/8	9.5	M20X1.5	24	1.46	37.0	2.37	60.1	1.27	32.2	12.0
G25730-0614	6G-14FDHORX90	7100-96225	3/8	9.5	M22X1.5	27	1.57	40.0	2.37	60.3	1.28	32.4	14.0
G25730-0814	8G-14FDHORX90	7100-13005	1/2	12.7	M22X1.5	27	2.01	51.0	3.11	79.0	1.64	41.6	14.0
G25730-0816	8G-16FDHORX90	7100-96515	1/2	12.7	M24X1.5	30	1.73	44.0	3.06	77.8	1.59	40.3	16.0
G25730-1020	10G-20FDHORX90	7100-99585	5/8	15.9	M30X2.0	36	2.01	51.0	3.31	84.1	1.84	46.8	20.0
G25730-1025	10G-25FDHORX90	7100-99605	5/8	15.9	M36X2.0	46	2.52	64.0	3.31	84.1	1.84	46.8	25.0
G25730-1220	12G-20FDHORX90	7100-96745	3/4	19.1	M30X2.0	36	2.01	51.0	3.95	100.3	1.94	49.3	20.0
G25730-1225	12G-25FDHORX90	7100-96765	3/4	19.1	M36X2.0	46	2.52	64.0	4.22	107.3	2.22	56.3	25.0
G25730-1625	16G-25FDHORX90	7100-94925	1	25.4	M36X2.0	46	2.99	76.0	5.43	137.8	3.19	81.0	25.0
G25730-2038	20G-38FDHORX90	7100-94935	1 1/4	31.8	M52X2.0	60	3.43	87.1	5.96	151.4	3.64	92.5	38.0

- EQUIPMENT
- HOSE/CPLG. SELECTION
- G8K COUPLINGS
- GLOBALSPIRAL COUPLINGS
- STAINLESS STEEL SPIRAL
- MEGACRIMP COUPLINGS
- STAINLESS STEEL BRAID
- POWER CRIMP COUPLINGS
- FIELD ATTACHABLE G1 & G2 COUPLINGS
- FIELD ATTACHABLE C5 COUPLINGS
- C14 COUPLINGS
- GL COUPLINGS
- GLX COUPLINGS
- PCTS THERMOPLASTIC COUPLINGS
- POLARSEAL COUPLINGS (ACA)
- POLARSEAL II COUPLINGS (ACC)
- POLARSEAL II COUPLINGS (ACB)
- POWER STEERING
- ADAPTERS
- QUICK DISCONNECT COUPLERS
- BALL VALVES
- LIVE SWIVEL
- ASSEMBLY FABRICATION
- ACCESSORIES
- EQUIPMENT AND PARTS
- KITS
- AIR BRAKE HOSE ASSY
- BRASS





EQUIPMENT
HOSE/CPLG. SELECTION
G8K COUPLINGS
GLOBAL SPIRAL COUPLINGS
STAINLESS STEEL SPIRAL
<b>MEGACRIMP COUPLINGS</b>
STAINLESS STEEL BRAID
POWER CRIMP COUPLINGS
FIELD ATTACHABLE G1 & G2 COUPLINGS
FIELD ATTACHABLE C5 COUPLINGS
C14 COUPLINGS
GL COUPLINGS
GLX COUPLINGS
PCTS THERMOPLASTIC COUPLINGS
POLARSEAL COUPLINGS (ACA)
POLARSEAL II COUPLINGS (ACC)
POLARSEAL II COUPLINGS (ACB)
POWER STEERING
ADAPTERS
QUICK DISCONNECT COUPLERS
BALL VALVES
LIVE SWIVEL
ASSEMBLY FABRICATION
ACCESSORIES
EQUIPMENT AND PARTS
KITS
AIR BRAKE HOSE ASSY
BRASS

### Metric Light Stand Pipe

See Metric Stand Pipe Assembly in the Hose/Coupling Selection Section for sleeve and nut selection. See Accessories for Metric Bite Sleeve and Metric Bite Nut part numbers.

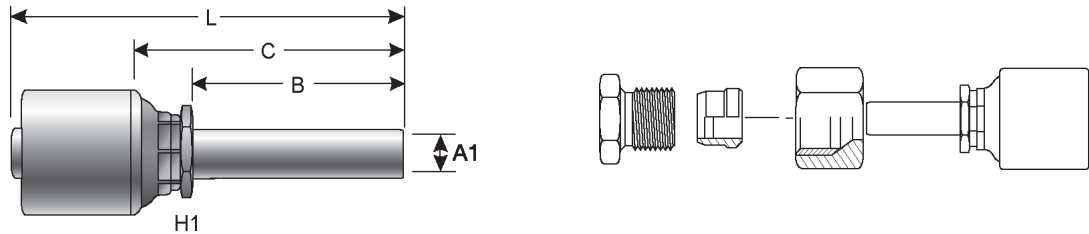

Part No.	Descr.	Prod. No.	⌀		H1	L		C		B		A1
			"	mm		"	mm	"	mm	"	mm	
G25750-0406	4G-6MSP	7100-93355	1/4	6.4	1/2	2.46	62.5	1.44	36.5	.87	22.0	6.0
G25750-0408	4G-8MSP	7100-93365	1/4	6.4	1/2	2.46	62.5	1.44	36.5	.87	22.0	8.0
G25750-0410	4G-10MSP	7100-93375	1/4	6.4	1/2	2.54	64.5	1.52	38.5	.87	22.0	10.0
G25750-0610	6G-10MSP	7100-90325	3/8	9.5	5/8	2.62	66.5	1.52	38.6	.91	23.0	10.0
G25750-0612	6G-12MSP	7100-90005	3/8	9.5	5/8	2.62	66.5	1.52	38.6	.91	23.0	12.0
G25750-0815	8G-15MSP	7100-90045	1/2	12.7	13/16	3.00	76.3	1.53	38.8	.98	25.0	15.0
G25750-1018	10G-18MSP	7100-99695	5/8	15.9	15/16	3.03	77.0	1.56	39.5	.98	25.0	18.0
G25750-1022	10G-22MSP	7100-95335	5/8	15.9	15/16	3.11	79.0	1.63	41.5	.98	25.0	22.0
G25750-1218	12G-18MSP	7100-95345	3/4	19.1	1 1/16	3.54	90.0	1.54	39.0	1.02	26.0	18.0
G25750-1222	12G-22MSP	7100-93465	3/4	19.1	1 1/16	3.67	93.2	1.66	42.2	1.10	28.0	22.0
G25750-1628	16G-28MSP	7100-95355	1	25.4	1 7/16	4.09	104.0	1.86	47.2	1.18	30.0	28.0

### International Thread Metric 7642 DIN Banjo

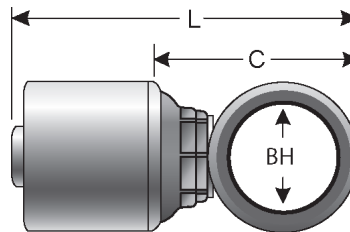

Part No.	Descr.	Prod. No.	⌀		L		C		BH
			"	mm	"	mm	"	mm	
G25770-0412	4G-12DBJ	7100-91195	1/4	6.4	2.03	51.4	1.11	28.3	12.1
G25770-0612	6G-12DBJ	7100-98125	3/8	9.5	2.20	56.0	1.11	28.1	12.1
G25770-0614	6G-14DBJ	7100-98655	3/8	9.5	2.30	58.3	1.20	30.4	14.1
G25770-0616	6G-16DBJ	7100-91285	3/8	9.5	2.20	55.8	1.27	32.4	16.1
G25770-0618	6G-18DBJ	7100-91295	3/8	9.5	2.28	57.8	1.35	34.4	18.1
G25770-0818	8G-18DBJ	7100-91305	1/2	12.7	2.64	67.2	1.37	34.7	18.1
G25770-1022	10G-22DBJ	7100-99725	5/8	15.9	3.00	76.2	1.52	38.6	22.1
G25770-1226	12G-26DBJ	7100-25005	3/4	19.1	3.73	94.7	1.72	43.7	26.1
G25770-1630	16G-30DBJ	7100-94995	1	25.4	4.30	109.2	2.06	52.4	30.1



## Male British Standard Pipe Tapered/Japanese Tapered Thread



Part No.	Descr.	Prod. No.	⊖		H1	L		C		
			"	mm		"	mm	"	mm	
G25795-0404	4G-4MBSPT	7100-91075	1/4	6.4	1/4-19	14	1.89	48.0	.97	24.8
G25795-0606	6G-6MBSPT	7100-91105	3/8	9.5	3/8-19	19	1.95	49.5	1.03	26.1
G25795-0808	8G-8MBSPT	7100-91125	1/2	12.7	1/2-14	22	2.49	63.4	1.22	30.9
G25795-1010	10G-10MBSPT	7100-99645	5/8	15.9	5/8-14	24	2.76	70.0	1.28	32.5
G25795-1212	12G-12MBSPT	7100-99925	3/4	19.1	3/4-14	32	3.50	89.0	1.50	38.0
G25795-1616	16G-16MBSPT	7100-91155	1	25.4	1-11	36	3.44	87.5	1.64	41.6

## Male British Standard Parallel Pipe



Part No.	Descr.	Prod. No.	⊖		H1	L		C		
			"	mm		"	mm	"	mm	
G25810-0404	4G-4MBSPP	7100-15515	1/4	6.4	1/4-19	19	2.03	51.5	1.00	25.4
G25810-0604	6G-4MBSPP	7100-98255	3/8	9.5	1/4-19	19	2.05	52.0	.95	24.1
G25810-0606	6G-6MBSPP	7100-15525	3/8	9.5	3/8-19	22	2.17	55.0	1.07	27.1
G25810-0608	6G-8MBSPP	7100-15535	3/8	9.5	1/2-14	27	2.36	60.0	1.26	32.1
G25810-0806	8G-6MBSPP	7100-93245	1/2	12.7	3/8-19	22	2.30	58.5	1.02	26.0
G25810-0808	8G-8MBSPP	7100-05545	1/2	12.7	1/2-14	27	2.72	69.0	1.24	31.5
G25810-1010	10G-10MBSPP	7100-99625	5/8	15.9	5/8-14	30	2.83	72.0	1.36	34.5
G25810-1012	10G-12MBSPP	7100-99655	5/8	15.9	3/4-14	32	2.91	74.0	1.44	36.5
G25810-1212	12G-12MBSPP	7100-99905	3/4	19.1	3/4-14	32	3.54	90.0	1.54	39.0
G25810-1616	16G-16MBSPP	7100-05575	1	25.4	1-11	41	3.98	101.0	1.74	44.2
G25810-2020	20G-20MBSPP	7100-05585	1 1/4	31.8	1 1/4-11	50	4.33	110.0	2.01	51.0

- EQUIPMENT
- HOSE/CPLG. SELECTION
- G8K COUPLINGS
- GLOBALSPIRAL COUPLINGS
- STAINLESS STEEL SPIRAL
- MEGACRIMP COUPLINGS**
- STAINLESS STEEL BRAID
- POWER CRIMP COUPLINGS
- FIELD ATTACHABLE G1 & G2 COUPLINGS
- FIELD ATTACHABLE C5 COUPLINGS
- C14 COUPLINGS
- GL COUPLINGS
- GLX COUPLINGS
- PCTS THERMOPLASTIC COUPLINGS
- POLARSEAL COUPLINGS (ACA)
- POLARSEAL II COUPLINGS (ACC)
- POLARSEAL II COUPLINGS (ACB)
- POWER STEERING
- ADAPTERS
- QUICK DISCONNECT COUPLERS
- BALL VALVES
- LIVE SWIVEL
- ASSEMBLY FABRICATION
- ACCESSORIES
- EQUIPMENT AND PARTS
- KITS
- AIR BRAKE HOSE ASSY
- BRASS



EQUIPMENT
HOSE/CPLG. SELECTION
G8K COUPLINGS
GLOBAL SPIRAL COUPLINGS
STAINLESS STEEL SPIRAL
<b>MEGACRIMP COUPLINGS</b>
STAINLESS STEEL BRAID
POWER CRIMP COUPLINGS
FIELD ATTACHABLE G1 & G2 COUPLINGS
FIELD ATTACHABLE C5 COUPLINGS
C14 COUPLINGS
GL COUPLINGS
GLX COUPLINGS
PCTS THERMOPLASTIC COUPLINGS
POLARSEAL COUPLINGS (ACA)
POLARSEAL II COUPLINGS (ACC)
POLARSEAL II COUPLINGS (ACB)
POWER STEERING
ADAPTERS
QUICK DISCONNECT COUPLERS
BALL VALVES
LIVE SWIVEL
ASSEMBLY FABRICATION
ACCESSORIES
EQUIPMENT AND PARTS
KITS
AIR BRAKE HOSE ASSY
BRASS

## Female British Standard Parallel Pipe O-Ring Swivel

Includes O-Ring sealing in flare.

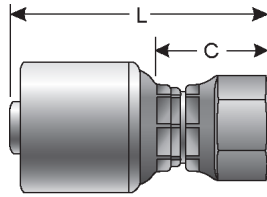

H2

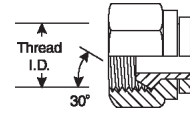

Part No.	Descr.	Prod. No.	⊖		H2	L		C		
			"	mm		"	mm	"	mm	
G25830-0402	4G-2FBSPPX	7100-97325	1/4	6.4	1/8-28	14	1.62	41.1	.71	18.0
G25830-0404	4G-4FBSPORX	7100-95915	1/4	6.4	1/4-19	19	1.69	43.0	1.22	31.1
G25830-0406	4G-6FBSPORX	7100-95925	1/4	6.4	3/8-19	32	2.82	71.6	.81	20.6
G25830-0506	5G-6FBSPORX	7100-95025	5/16	7.9	3/8-19	22	2.13	54.0	1.02	26.0
G25830-0508	5G-8FBSPORX	7100-94205	5/16	7.9	1/2-14	27	2.16	54.8	1.06	26.8
G25830-0606	6G-6FBSPORX	7100-96295	3/8	9.5	3/8-19	22	1.74	44.2	.64	16.2
G25830-0608	6G-8FBSPORX	7100-96305	3/8	9.5	1/2-14	27	1.80	45.8	.71	17.9
G25830-0806	8G-6FBSPORX	7100-97895	1/2	12.7	3/8-19	22	2.62	66.5	1.14	29.0
G25830-0808	8G-8FBSPORX	7100-96535	1/2	12.7	1/2-14	27	2.19	55.5	.70	17.8
G25830-0810	8G-10FBSPORX	7100-96545	1/2	12.7	5/8-14	30	2.25	57.2	.78	19.8
G25830-0812	8G-12FBSPORX	7100-96555	1/2	12.7	3/4-14	32	2.32	59.0	.85	21.5
G25830-1010	10G-10FBSPORX	7100-99445	5/8	15.9	5/8-14	30	2.20	56.0	.73	18.5
G25830-1012	10G-12FBSPORX	7100-99485	5/8	15.9	3/4-14	32	2.28	58.0	.81	20.5
G25830-1212	12G-12FBSPORX	7100-99825	3/4	19.1	3/4-14	32	2.82	71.6	.81	20.6
G25830-1216	12G-16FBSPORX	7100-99835	3/4	19.1	1-11	41	2.89	73.3	.88	22.3
G25830-1616	16G-16FBSPORX	7100-95155	1	25.4	1-11	41	3.78	96.0	1.54	39.2
G25830-2020	20G-20FBSPORX	7100-95235	1 1/4	31.8	1 1/4-11	50	3.48	88.5	1.16	29.5

## Female British Standard Parallel Pipe O-Ring Swivel - 45° Bent Tube

Includes O-Ring sealing in flare.

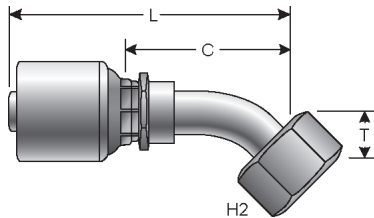

H2

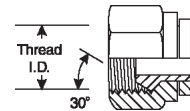

Part No.	Descr.	Prod. No.	⊖		H2	T		L		C		
			"	mm		"	mm	"	mm	"	mm	
G25831-0404	4G-4FBSPORX45	7100-95935	1/4	6.4	1/4-19	19	.46	11.5	2.25	57.1	1.22	31.1
G25831-0606	6G-6FBSPORX45	7100-96315	3/8	9.5	3/8-19	22	.60	15.2	2.63	66.9	1.54	39.0
G25831-0608	6G-8FBSPORX45	7100-96325	3/8	9.5	1/2-14	22	.76	19.3	2.79	71.0	1.69	43.0
G25831-0808	8G-8FBSPORX45	7100-96565	1/2	12.7	1/2-14	27	.67	17.0	3.21	81.5	1.73	44.0
G25831-0810	8G-10FBSPORX45	7100-96575	1/2	12.7	5/8-14	30	.91	23.0	3.53	89.8	2.06	52.3
G25831-1010	10G-10FBSPORX45	7100-99455	5/8	15.9	5/8-14	30	.84	21.3	3.53	89.6	2.05	52.1
G25831-1012	10G-12FBSPORX45	7100-99495	5/8	15.9	3/4-14	32	1.27	32.2	3.92	99.5	2.44	62.0
G25831-1212	12G-12FBSPORX45	7100-96795	3/4	19.1	3/4-14	32	1.11	28.3	4.54	115.4	2.54	64.4
G25831-1616	16G-16FBSPORX45	7100-91535	1	25.4	1-11	41	1.22	30.9	4.87	123.6	3.10	78.8
G25831-2020	20G-20FBSPORX45	7100-92715	1 1/4	31.8	1 1/4-11	50	1.48	37.5	5.50	139.6	3.68	93.4



## Female British Standard Parallel Pipe O-Ring Swivel - 90° Bent Tube

Includes O-Ring sealing in flare.

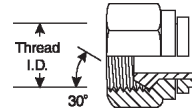
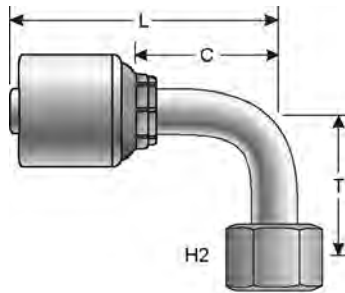

Part No.	Descr.	Prod. No.	⊖		H2	T		L		C		
			"	mm		"	mm	"	mm	"	mm	
G25832-0404	4G-4FBSPORX90	7100-95955	1/4	6.4	1/4-19	19	.93	23.3	2.07	52.5	1.04	26.5
G25832-0606	6G-6FBSPORX90	7100-96335	3/8	9.5	3/8-19	22	1.26	32.0	2.44	61.9	1.34	34.0
G25832-0608	6G-8FBSPORX90	7100-96345	3/8	9.5	1/2-14	22	1.48	37.5	2.37	60.1	1.27	32.2
G25832-0808	8G-8FBSPORX90	7100-96585	1/2	12.7	1/2-14	27	1.47	37.3	3.07	78.0	1.59	40.5
G25832-0810	8G-10FBSPORX90	7100-96595	1/2	12.7	5/8-14	30	1.81	46.0	3.16	80.2	1.69	42.8
G25832-1010	10G-10FBSPORX90	7100-99465	5/8	15.9	5/8-14	30	1.81	46.0	3.31	84.1	1.84	46.6
G25832-1012	10G-12FBSPORX90	7100-99505	5/8	15.9	3/4-14	32	2.36	60.0	3.31	84.1	1.84	46.6
G25832-1212	12G-12FBSPORX90	7100-96805	3/4	19.1	3/4-14	32	2.36	60.0	4.21	107.0	2.21	56.0
G25832-1216	12G-16FBSPORX90	7100-96815	3/4	19.1	1-11	41	2.76	70.0	4.42	112.2	2.41	61.2
G25832-1616	16G-16FBSPORX90	7100-91635	1	25.4	1-11	41	2.76	70.0	4.69	119.2	2.93	74.3
G25832-2020	20G-20FBSPORX90	7100-91645	1 1/4	31.8	1 1/4-11	50	3.15	80.0	5.07	128.8	3.26	82.8

## Female British Standard Parallel Pipe O-Ring Swivel - 90° Block

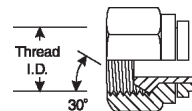
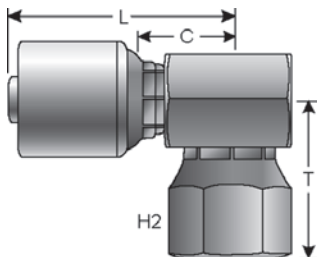

Part No.	Descr.	Prod. No.	⊖		H2	T		L		C		
			"	mm		"	mm	"	mm	"	mm	
G25845-0404	4G-4FBSPORX90BL	7100-91825	1/4	6.4	1/4-19	19	.71	18.0	1.74	44.2	.72	18.2
G25845-0606	6G-6FBSPORX90BL	7100-91835	3/8	9.5	3/8-19	22	.83	21.0	1.71	43.5	.79	20.0
G25845-0808	8G-8FBSPORX90BL	7100-91845	1/2	12.7	1/2-14	27	.94	24.0	2.20	55.9	.93	23.5
G25845-1616	16G-16FBSPORX90BL	7100-92585	1	25.4	1-11	41	1.42	36.1	3.17	80.5	1.36	34.6

- EQUIPMENT
- HOSE/CPLG. SELECTION
- G8K COUPLINGS
- GLOBALSPIRAL COUPLINGS
- STAINLESS STEEL SPIRAL
- MEGACRIMP COUPLINGS**
- STAINLESS STEEL BRAID
- POWER CRIMP COUPLINGS
- FIELD ATTACHABLE G1 & G2 COUPLINGS
- FIELD ATTACHABLE C5 COUPLINGS
- C14 COUPLINGS
- GL COUPLINGS
- GLX COUPLINGS
- PCTS THERMOPLASTIC COUPLINGS
- POLARSEAL COUPLINGS (ACA)
- POLARSEAL II COUPLINGS (ACC)
- POLARSEAL II COUPLINGS (ACB)
- POWER STEERING
- ADAPTERS
- QUICK DISCONNECT COUPLERS
- BALL VALVES
- LIVE SWIVEL
- ASSEMBLY FABRICATION
- ACCESSORIES
- EQUIPMENT AND PARTS
- KITS
- AIR BRAKE HOSE ASSY
- BRASS



EQUIPMENT
HOSE/CPLG. SELECTION
G8K COUPLINGS
GLOBAL SPIRAL COUPLINGS
STAINLESS STEEL SPIRAL
<b>MEGACRIMP COUPLINGS</b>
STAINLESS STEEL BRAID
POWER CRIMP COUPLINGS
FIELD ATTACHABLE G1 & G2 COUPLINGS
FIELD ATTACHABLE C5 COUPLINGS
C14 COUPLINGS
GL COUPLINGS
GLX COUPLINGS
PCTS THERMOPLASTIC COUPLINGS
POLARSEAL COUPLINGS (ACA)
POLARSEAL II COUPLINGS (ACC)
POLARSEAL II COUPLINGS (ACB)
POWER STEERING
ADAPTERS
QUICK DISCONNECT COUPLERS
BALL VALVES
LIVE SWIVEL
ASSEMBLY FABRICATION
ACCESSORIES
EQUIPMENT AND PARTS
KITS
AIR BRAKE HOSE ASSY
BRASS

### International Thread British Std Pipe Banjo

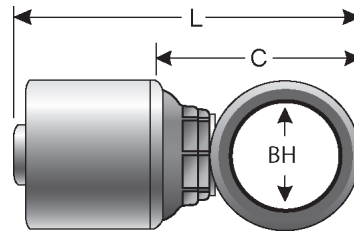

Part No.	Descr.	Prod. No.	⌀		L		C		BH
			"	mm	"	mm	"	mm	
G25850-0404	4G-4BSPBJ	7100-97305	1/4	6.4	2.10	53.4	1.19	30.3	13.2
G25850-0606	6G-6BSPBJ	7100-97635	3/8	9.5	2.20	55.8	1.30	32.4	16.8
G25850-0808	8G-8BSPBJ	7100-92925	1/2	12.7	2.80	70.7	1.50	38.2	21.0
G25850-1212	12G-12BSPBJ	7100-99815	3/4	19.1	3.73	94.7	1.72	43.7	26.5

### Female British Flat-Face Swivel



Part No.	Descr.	Prod. No.	⌀		H2	L		C		
			"	mm		"	mm	"	mm	
G25855-0606	6G-6FBFFX	7100-96375	3/8	9.5	3/8-19	22	1.75	44.5	.65	16.6
G25855-0608	6G-8FBFFX	7100-96385	3/8	9.5	1/2-14	27	1.73	44.0	.63	16.1
G25855-0808	8G-8FBFFX	7100-96605	1/2	12.7	1/2-14	27	2.11	53.5	.63	16.0
G25855-0812	8G-12FBFFX	7100-96625	1/2	12.7	3/4-14	32	2.03	51.5	.55	14.0
G25855-1012	10G-12FBFFX	7100-99515	5/8	15.9	3/4-14	32	2.05	52.0	.58	14.5
G25855-1212	12G-12FBFFX	7100-93325	3/4	19.1	3/4-14	32	2.07	52.6	1.04	26.4



## Female Komatsu Style Japanese Metric Swivel

These female swivels have been marked with two small notches on the hex to identify them as the Komatsu style.

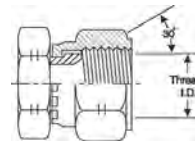
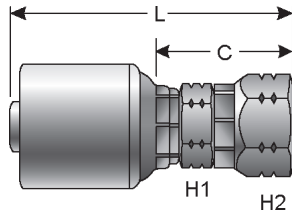

Part No.	Descr.	Prod. No.	⌀		Thread	H1	H2	L		C	
			"	mm				"	mm	"	mm
G25910-0404	4G-4FKX	7100-03625	1/4	6.4	M14X1.5	14	19	2.35	59.7	1.33	33.7
G25910-0406	4G-6FKX	7100-03635	1/4	6.4	M18X1.5	14	24	2.44	62.0	1.42	36.0
G25910-0606	6G-6FKX	7100-03645	3/8	9.5	M18X1.5	17	24	2.52	64.0	1.42	36.1
G25910-0808	8G-8FKX	7100-03655	1/2	12.7	M22X1.5	22	27	3.07	78.1	1.60	40.6
G25910-1010	10G-10FKX	7100-03665	5/8	15.9	M24X1.5	24	32	3.21	81.5	1.73	44.0
G25910-1212	12G-12FKX	7100-03675	3/4	19.1	M30X1.5	30	36	3.95	100.3	1.94	49.3
G25910-1616	16G-16FKX	7100-03685	1	25.4	M33X1.5	41	41	4.57	116.0	2.33	59.2
G25910-2020	20G-20FKX	7100-03775	1 1/4	31.8	M36X1.5	44.5	50.8	4.82	122.4	2.44	62.0

## Female Komatsu Style Japanese Metric Swivel - 45° Bent Tube

These female swivels have been marked with two small notches on the hex to identify them as the Komatsu style.

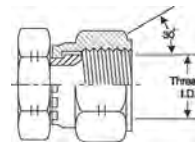
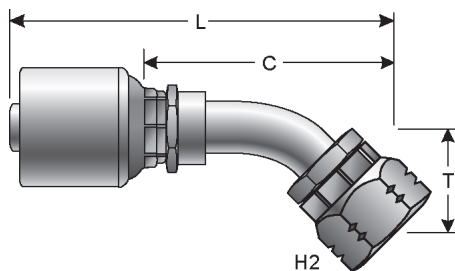

Part No.	Descr.	Prod. No.	⌀		Thread	H2	T		L		C	
			"	mm			"	mm	"	mm	"	mm
G25911-0404	4G-4FKX45	7100-03035	1/4	6.4	M14X1.5	19	.75	19.1	2.93	74.3	1.90	48.3
G25911-0606	6G-6FKX45	7100-03045	3/8	9.5	M18X1.5	24	1.10	28.0	3.64	92.4	2.54	64.4
G25911-0808	8G-8FKX45	7100-03055	1/2	12.7	M22X1.5	27	.71	18.0	3.85	97.7	2.37	60.3
G25911-1010	10G-10FKX45	7100-03065	5/8	15.9	M24X1.5	32	1.10	28.0	4.70	119.3	3.22	81.8
G25911-1212	12G-12FKX45	7100-03075	3/4	19.1	M30X1.5	36	1.18	30.0	5.64	143.2	3.63	92.2

- EQUIPMENT
- HOSE/CPLG. SELECTION
- G8K COUPLINGS
- GLOBALSPIRAL COUPLINGS
- STAINLESS STEEL SPIRAL
- MEGACRIMP COUPLINGS**
- STAINLESS STEEL BRAID
- POWER CRIMP COUPLINGS
- FIELD ATTACHABLE G1 & G2 COUPLINGS
- FIELD ATTACHABLE C5 COUPLINGS
- C14 COUPLINGS
- GL COUPLINGS
- GLX COUPLINGS
- PCTS THERMOPLASTIC COUPLINGS
- POLARSEAL COUPLINGS (ACA)
- POLARSEAL II COUPLINGS (ACC)
- POLARSEAL II COUPLINGS (ACB)
- POWER STEERING
- ADAPTERS
- QUICK DISCONNECT COUPLERS
- BALL VALVES
- LIVE SWIVEL
- ASSEMBLY FABRICATION
- ACCESSORIES
- EQUIPMENT AND PARTS
- KITS
- AIR BRAKE HOSE ASSY
- BRASS



EQUIPMENT
HOSE/CPLG. SELECTION
G8K COUPLINGS
GLOBALSPIRAL COUPLINGS
STAINLESS STEEL SPIRAL
<b>MEGACRIMP COUPLINGS</b>
STAINLESS STEEL BRAID
POWER CRIMP COUPLINGS
FIELD ATTACHABLE G1 & G2 COUPLINGS
FIELD ATTACHABLE C5 COUPLINGS
C14 COUPLINGS
GL COUPLINGS
GLX COUPLINGS
PCTS THERMOPLASTIC COUPLINGS
POLARSEAL COUPLINGS (ACA)
POLARSEAL II COUPLINGS (ACC)
POLARSEAL II COUPLINGS (ACB)
POWER STEERING
ADAPTERS
QUICK DISCONNECT COUPLERS
BALL VALVES
LIVE SWIVEL
ASSEMBLY FABRICATION
ACCESSORIES
EQUIPMENT AND PARTS
KITS
AIR BRAKE HOSE ASSY
BRASS

## Female Komatsu Style Japanese Metric Swivel - 90° Bent Tube

These female swivels have been marked with two small notches on the hex to identify them as the Komatsu style.

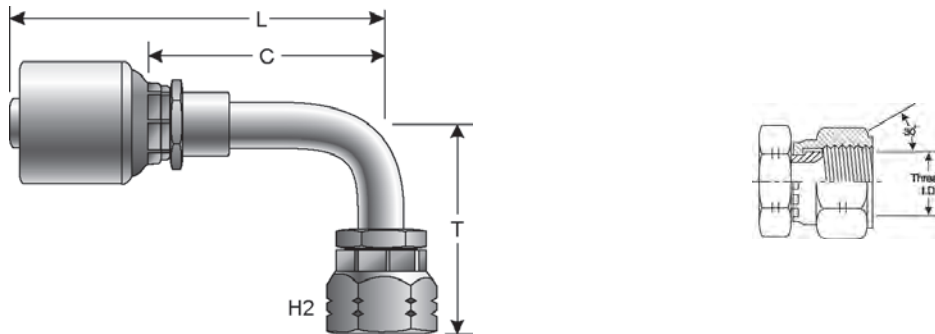

Part No.	Descr.	Prod. No.	⊖		🌀	H1	H2		T		L		C	
			"	mm			"	mm	"	mm	"	mm	"	mm
G25913-0404	4G-4FKX90	7100-03125	1/4	6.4	M14X1.5	—	—	19	1.50	38.0	2.47	62.7	1.44	36.7
G25913-0606	6G-6FKX90	7100-03135	3/8	9.5	M18X1.5	—	—	24	1.10	28.0	2.72	69.1	1.62	41.2
G25913-0808	8G-8FKX90	7100-03145	1/2	12.7	M22X1.5	—	—	27	1.38	35.0	3.63	92.2	2.15	54.7
G25913-1010	10G-10FKX90	7100-06795	5/8	15.9	M24X1.5	15/16	1 1/4	—	2.57	65.3	3.43	87.0	1.95	49.5
G25913-1212	12G-12FKX90	7100-03165	3/4	19.1	M30X1.5	—	—	36	2.48	63.0	5.33	135.5	3.33	84.5

## Female Japanese Industrial Standard Swivel



Part No.	Descr.	Prod. No.	⊖		🌀	H1	H2	L		C	
			"	mm				"	mm	"	mm
G25930-0404	4G-4FJISX	7100-03305	1/4	6.4	1/4-19	14	19	2.32	59.0	1.30	33.0
G25930-0606	6G-6FJISX	7100-03325	3/8	9.5	3/8-19	17	22	2.46	62.5	1.36	34.6
G25930-0808	8G-8FJISX	7100-03345	1/2	12.7	1/2-14	22	27	3.15	79.9	1.67	42.4
G25930-1212	12G-12FJISX	7100-03365	3/4	19.1	3/4-14	30	36	3.79	96.3	1.78	45.3
G25930-1616	16G-16FJISX	7100-03385	1	25.4	1-11	41	41	4.28	108.6	2.04	51.8
G25930-2020	20G-20FJISX	7100-03405	1 1/4	31.8	1 1/4-11	50	50	4.89	124.1	2.56	65.1





## Female Japanese Inverted Flare Parallel Threads

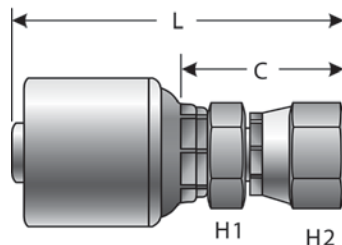

Part No.	Descr.	Prod. No.	⊖		H1	H2	L		C		
			"	mm			"	mm	"	mm	"
G25932-0404	4G-4FJISPX	7100-20445	1/4	6.4	1/4-19	15	19	2.01	51.0	.98	25.0
G25932-0606	6G-6FJISPX	7100-20455	3/8	9.5	3/8-19	18	22	2.17	55.0	1.03	26.2
G25932-0808	8G-8JISPX	7100-20465	1/2	12.7	1/2-14	22	27	2.56	65.0	1.16	29.5
G25932-1212	12G-12JISPX	7100-20485	3/4	19.1	3/4-14	30	36	3.37	85.5	1.36	34.5
G25932-1616	16G-16JISPX	7100-20495	1	25.4	1-11	41	41	3.84	97.5	1.60	40.7
G25932-2020	20G-20FJISPX	7100-20505	1 1/4	31.8	1 1/4-11	41	50	4.29	109.0	1.97	50.0

## Male Quick-Lok® High

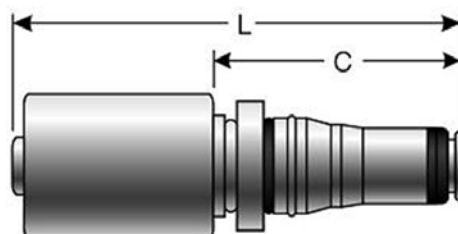

Part No.	Descr.	Prod. No.	⊖		L		C	
			"	mm	"	mm	"	mm
G25970-0404	4G-4MQLH	7209-32005	1/4	6.4	2.64	67.0	1.61	41.0
G25970-0606	6G-6MQLH	7209-32025	3/8	9.5	2.72	69.0	1.62	41.1
G25970-0808	8G-8MQLH	7209-32055	1/2	12.7	3.11	79.0	1.63	41.5
G25970-1010	10G-10MQLH	7209-32085	5/8	15.9	3.11	79.0	1.63	41.5
G25970-1212	12G-12MQLH	7209-32105	3/4	19.1	3.66	93.0	1.65	42.0
G25970-1616	16G-16MQLH	7209-32125	1	25.4	3.98	101.0	1.74	44.2

EQUIPMENT
HOSE/CPLG. SELECTION
G8K COUPLINGS
GLOBALSPIRAL COUPLINGS
STAINLESS STEEL SPIRAL
MEGACRIMP COUPLINGS
STAINLESS STEEL BRAID
POWER CRIMP COUPLINGS
FIELD ATTACHABLE G1 & G2 COUPLINGS
FIELD ATTACHABLE C5 COUPLINGS
C14 COUPLINGS
GL COUPLINGS
GLX COUPLINGS
PCTS THERMOPLASTIC COUPLINGS
POLARSEAL COUPLINGS (ACA)
POLARSEAL II COUPLINGS (ACC)
POLARSEAL II COUPLINGS (ACB)
POWER STEERING
ADAPTERS
QUICK DISCONNECT COUPLERS
BALL VALVES
LIVE SWIVEL
ASSEMBLY FABRICATION
ACCESSORIES
EQUIPMENT AND PARTS
KITS
AIR BRAKE HOSE ASSY
BRASS



EQUIPMENT
HOSE/CPLG. SELECTION
G8K COUPLINGS
GLOBALSPIRAL COUPLINGS
STAINLESS STEEL SPIRAL
<b>MEGACRIMP COUPLINGS</b>
STAINLESS STEEL BRAID
POWER CRIMP COUPLINGS
FIELD ATTACHABLE G1 & G2 COUPLINGS
FIELD ATTACHABLE C5 COUPLINGS
C14 COUPLINGS
GL COUPLINGS
GLX COUPLINGS
PCTS THERMOPLASTIC COUPLINGS
POLARSEAL COUPLINGS (ACA)
POLARSEAL II COUPLINGS (ACC)
POLARSEAL II COUPLINGS (ACB)
POWER STEERING
ADAPTERS
QUICK DISCONNECT COUPLERS
BALL VALVES
LIVE SWIVEL
ASSEMBLY FABRICATION
ACCESSORIES
EQUIPMENT AND PARTS
KITS
AIR BRAKE HOSE ASSY
BRASS

### Male Quick-Lok® High - 45° Bent Tube

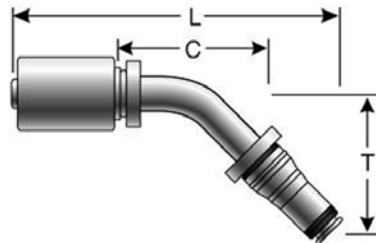

Part No.	Descr.	Prod. No.	⊖		T		L		C	
			"	mm	"	mm	"	mm	"	mm
G25971-0404	4G-4MLH45S-008	7209-33005	1/4	6.4	.30	7.5	2.96	75.1	1.93	49.1
G25971-0606	6G-6MLH45S-008	7209-33015	3/8	9.5	.33	8.4	3.21	81.6	2.11	53.7
G25971-0808	8G-8MLH45S-010	7209-33025	1/2	12.7	.41	10.4	3.77	95.7	2.29	58.2
G25971-1010	10G-10MLH45S-013	7209-33045	5/8	15.9	.50	12.7	4.12	104.6	2.64	67.1
G25971-1212	12G-12MLH45S-014	7209-33055	3/4	19.1	.56	14.2	4.88	124.0	2.87	73.0
G25971-1616	16G-16MLH45S-017	7209-33065	1	25.4	.66	16.8	5.49	139.5	3.26	82.7

### Male Quick-Lok® High - 90° Bent Tube

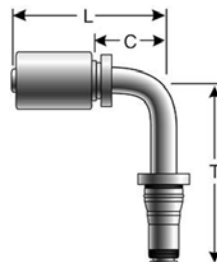

Part No.	Descr.	Prod. No.	⊖		T		L		C	
			"	mm	"	mm	"	mm	"	mm
G25972-0404	4G-4MLH90S-018	7209-34005	1/4	6.4	.71	18.0	2.19	55.6	1.17	29.6
G25973-0404	4G-4MLH90L-039	7209-34015	1/4	6.4	1.54	39.0	2.19	55.6	1.17	29.6
G25972-0606	6G-6MLH90S-020	7209-34045	3/8	9.5	.79	20.1	2.47	62.8	1.37	34.8
G25973-0606	6G-6MLH90L-046	7209-34055	3/8	9.5	1.79	45.5	2.40	60.9	1.30	32.9
G25972-0808	8G-8MLH90S-026	7209-34085	1/2	12.7	1.01	25.6	3.16	80.3	1.69	42.9
G25973-0808	8G-8MLH90L-057	7209-34095	1/2	12.7	2.22	56.5	3.04	77.1	1.56	39.7
G25972-1010	10G-10MLH90S-033	7209-34115	5/8	15.9	1.29	32.8	3.55	90.1	2.07	52.6
G25973-1010	10G-10MLH90L-065	7209-34125	5/8	15.9	2.56	65.0	3.72	94.4	2.24	57.0
G25972-1212	12G-12MLH90S-037	7209-34155	3/4	19.1	1.45	36.8	4.33	110.1	2.33	59.1
G25973-1212	12G-12MLH90L-075	7209-34165	3/4	19.1	2.93	74.5	4.20	106.7	2.19	55.7
G25972-1616	16G-16MLH90S-044	7209-34195	1	25.4	1.72	43.8	5.48	139.1	3.24	82.3
G25973-1616	16G-16MLH90L-103	7209-34215	1	25.4	4.06	103.0	4.87	123.7	2.63	66.9



## Female Quick-Lok® High to Male O-Ring Boss Adapter

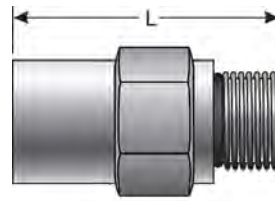

H1

Part No.	Descr.	Prod. No.	⊖		🌀	H1	L	
			"	mm			"	mm
G25974-0404	4FQLH-4MB	7209-05025	1/4	6.4	7/16-20	19	1.65	42.0
G25974-0406	4FQLH-6MB	7209-05035	1/4	6.4	9/16-18	19	1.65	42.0
G25974-0604	6FQLH-4MB	7209-05075	3/8	9.5	7/16-20	22	1.65	42.0
G25974-0606	6FQLH-6MB	7209-05085	3/8	9.5	9/16-18	22	1.69	43.0
G25974-0608	6FQLH-8MB	7209-05095	3/8	9.5	3/4-16	24	1.69	43.0
G25974-0806	8FQLH-6MB	7209-05135	1/2	12.7	9/16-18	24	1.71	43.5
G25974-0808	8FQLH-8MB	7209-05145	1/2	12.7	3/4-16	24	1.75	44.5
G25974-0810	8FQLH-10MB	7209-05155	1/2	12.7	7/8-14	27	1.81	46.0
G25974-1008	10FQLH-8MB	7209-05195	5/8	15.9	3/4-16	27	1.85	47.0
G25974-1010	10FQLH-10MB	7209-05205	5/8	15.9	7/8-14	27	1.85	47.0
G25974-1012	10FQLH-12MB	7209-05215	5/8	15.9	1 1/16-12	32	1.89	48.0
G25974-1210	12FQLH-10MB	7209-05255	3/4	19.1	7/8-14	32	1.89	48.0
G25974-1212	12FQLH-12MB	7209-05265	3/4	19.1	1 1/16-12	32	1.97	50.0
G25974-1216	12FQLH-16MB	7209-05275	3/4	19.1	1 5/16-12	41	1.97	50.0
G25974-1612	16FQLH-12MB	7209-05315	1	25.4	1 1/16-12	41	2.09	53.0
G25974-1616	16FQLH-16MB	7209-05325	1	25.4	1 5/16-12	41	1.97	50.0

## Female Quick-Lok® High to Female JIC 37° Flare

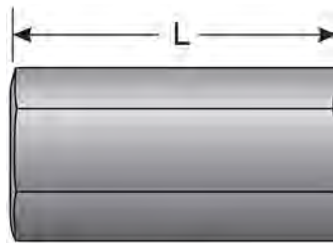

H1

Part No.	Descr.	Prod. No.	⊖		🌀	H1	L	
			"	mm			"	mm
G25976-0404	4FQLH-4FJ	7209-07505	1/4	6.4	7/16-20	19	1.69	42.9
G25976-0606	6FQLH-6FJ	7209-07535	3/8	9.5	9/16-18	22	1.69	42.9
G25976-0808	8FQLH-8FJ	7209-07565	1/2	12.7	3/4-16	24	1.81	46.0
G25976-1010	10FQLH-10FJ	7209-07595	5/8	15.9	7/8-14	27	1.93	49.0
G25976-1616	16FQLH-16FJ	7209-07655	1	25.4	1 5/16-12	41	2.11	53.6

- EQUIPMENT
- HOSE/CPLG. SELECTION
- G8K COUPLINGS
- GLOBALSPIRAL COUPLINGS
- STAINLESS STEEL SPIRAL
- MEGACRIMP COUPLINGS**
- STAINLESS STEEL BRAID
- POWER CRIMP COUPLINGS
- FIELD ATTACHABLE G1 & G2 COUPLINGS
- FIELD ATTACHABLE C5 COUPLINGS
- C14 COUPLINGS
- GL COUPLINGS
- GLX COUPLINGS
- PCTS THERMOPLASTIC COUPLINGS
- POLARSEAL COUPLINGS (ACA)
- POLARSEAL II COUPLINGS (ACC)
- POLARSEAL II COUPLINGS (ACB)
- POWER STEERING
- ADAPTERS
- QUICK DISCONNECT COUPLERS
- BALL VALVES
- LIVE SWIVEL
- ASSEMBLY FABRICATION
- ACCESSORIES
- EQUIPMENT AND PARTS
- KITS
- AIR BRAKE HOSE ASSY
- BRASS

EQUIPMENT
HOSE/CPLG. SELECTION
G8K COUPLINGS
GLOBAL SPIRAL COUPLINGS
STAINLESS STEEL SPIRAL
MEGACRIMP COUPLINGS
STAINLESS STEEL BRAID
POWER CRIMP COUPLINGS
FIELD ATTACHABLE G1 & G2 COUPLINGS
FIELD ATTACHABLE C5 COUPLINGS
C14 COUPLINGS
GL COUPLINGS
GLX COUPLINGS
PCTS THERMOPLASTIC COUPLINGS
POLARSEAL COUPLINGS (ACA)
POLARSEAL II COUPLINGS (ACC)
POLARSEAL II COUPLINGS (ACB)
POWER STEERING
ADAPTERS
QUICK DISCONNECT COUPLERS
BALL VALVES
LIVE SWIVEL
ASSEMBLY FABRICATION
ACCESSORIES
EQUIPMENT AND PARTS
KITS
AIR BRAKE HOSE ASSY
BRASS

## Female Quick-Lok® High to Female Flat-Face

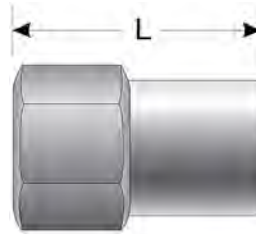

H1

Part No.	Descr.	Prod. No.	⊖		🌀	H1	L	
			"	mm			"	mm
G25978-0606	6FQLH-6FFOR	7209-07695	3/8	9.5	11/16-16	22	1.60	40.6
G25978-0808	8FQLH-8FFOR	7209-07705	1/2	12.7	13/16-16	24	1.66	42.2
G25978-1010	10FQLH-10FFOR	7209-07715	5/8	15.9	1-14	30	1.71	43.4
G25978-1212	12FQLH-12FFOR	7209-07725	3/4	19.1	1 3/16-12	36	1.77	45.0

## Male Quick-Lok® Low

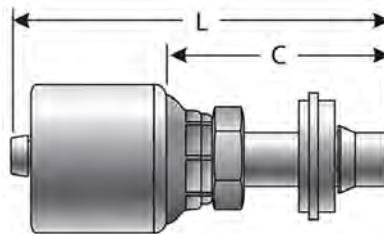

Part No.	Descr.	Prod. No.	⊖		L		C	
			"	mm	"	mm	"	mm
G25980-0406	4G-6MQLL	7101-51225	1/4	6.4	2.68	68.0	1.65	42.0
G25980-0606	6G-6MQLL	7101-51015	3/8	9.5	2.76	70.0	1.66	42.1
G25980-0808	8G-8MQLL	7101-50745	1/2	12.7	3.43	87.0	1.95	49.5
G25980-1212	12G-12MQLL	7101-51595	3/4	19.1	4.06	103.0	2.05	52.0
G25980-1616	16G-16MQLL	7101-51515	1	25.4	4.53	115.0	2.29	58.2



### Male Quick-Lok® Low - 45° Bent Tube

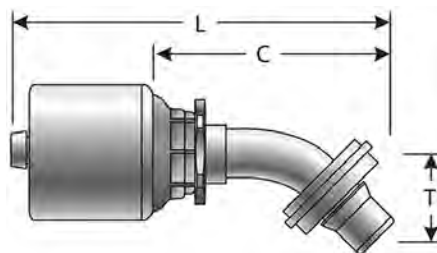

Part No.	Descr.	Prod. No.	⊖		T		L		C	
			"	mm	"	mm	"	mm	"	mm
G25981-0406	4G-6MQLL45-026	7101-51235	1/4	6.4	1.02	26.0	2.85	72.5	1.83	46.5
G25981-0808	8G-8MQLL45-033	7101-50765	1/2	12.7	1.30	33.0	3.94	100.0	2.46	62.5
G25981-1212	12G-12MQLL45-030	7101-51605	3/4	19.1	1.18	30.0	5.04	128.0	3.03	77.0
G25981-1212	12G-12MQLL45-038	7101-52325	3/4	19.1	1.50	38.1	5.35	135.9	3.35	85.1

### Male Quick-Lok® Low - 90° Bent Tube

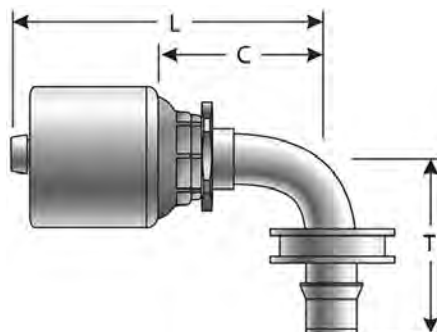

Part No.	Descr.	Prod. No.	⊖		T		L		C	
			"	mm	"	mm	"	mm	"	mm
G25982-0406	4G-6MQLL90-037	7101-51245	1/4	6.4	1.46	37.0	2.26	57.3	1.23	31.3
G25982-0606	6G-6MQLL90-051	7101-52265	3/8	9.5	2.01	51.0	2.60	66.0	1.50	38.0
G25983-0606	6G-6MQLL90-117	7101-51935	3/8	9.5	4.61	117.0	2.60	66.0	1.50	38.1
G25984-0606	6G-6MQLL90-168	7101-51775	3/8	9.5	7.09	180.0	2.60	66.0	1.50	38.1
G25982-0808	8G-8MQLL90-050	7101-51475	1/2	12.7	1.97	50.0	3.35	85.0	1.87	47.5
G25982-1212	12G-12MQLL90-061	7101-51615	3/4	19.1	2.40	61.0	4.25	108.0	2.24	57.0

EQUIPMENT
HOSE/CPLG. SELECTION
G8K COUPLINGS
GLOBALSPIRAL COUPLINGS
STAINLESS STEEL SPIRAL
<b>MEGACRIMP COUPLINGS</b>
STAINLESS STEEL BRAID
POWER CRIMP COUPLINGS
FIELD ATTACHABLE G1 & G2 COUPLINGS
FIELD ATTACHABLE C5 COUPLINGS
C14 COUPLINGS
GL COUPLINGS
GLX COUPLINGS
PCTS THERMOPLASTIC COUPLINGS
POLARSEAL COUPLINGS (ACA)
POLARSEAL II COUPLINGS (ACC)
POLARSEAL II COUPLINGS (ACB)
POWER STEERING
ADAPTERS
QUICK DISCONNECT COUPLERS
BALL VALVES
LIVE SWIVEL
ASSEMBLY FABRICATION
ACCESSORIES
EQUIPMENT AND PARTS
KITS
AIR BRAKE HOSE ASSY
BRASS



EQUIPMENT
HOSE/CPLG. SELECTION
G8K COUPLINGS
GLOBALSPIRAL COUPLINGS
STAINLESS STEEL SPIRAL
<b>MEGACRIMP COUPLINGS</b>
STAINLESS STEEL BRAID
POWER CRIMP COUPLINGS
FIELD ATTACHABLE G1 & G2 COUPLINGS
FIELD ATTACHABLE C5 COUPLINGS
C14 COUPLINGS
GL COUPLINGS
GLX COUPLINGS
PCTS THERMOPLASTIC COUPLINGS
POLARSEAL COUPLINGS (ACA)
POLARSEAL II COUPLINGS (ACC)
POLARSEAL II COUPLINGS (ACB)
POWER STEERING
ADAPTERS
QUICK DISCONNECT COUPLERS
BALL VALVES
LIVE SWIVEL
ASSEMBLY FABRICATION
ACCESSORIES
EQUIPMENT AND PARTS
KITS
AIR BRAKE HOSE ASSY
BRASS

### Male Pipe (NPTF - 30° Cone Seat)



Part No.	Descr.	Prod. No.	⊖		H1	L		C		
			"	mm		"	mm	"	mm	
G25100-0402T	4G-2MP-TCX	7321-50905	1/4	6.4	1/8-27	1/2	1.96	49.8	.94	23.9
G25100-0404T	4G-4MP-TCX	7321-50865	1/4	6.4	1/4-18	9/16	2.17	55.0	1.14	29.0
G25100-0406T	4G-6MP-TCX	7321-50885	1/4	6.4	3/8-18	11/16	2.17	55.0	1.14	29.0
G25100-0408T	4G-8MP-TCX	7321-50925	1/4	6.4	1/2-14	7/8	2.44	62.0	1.41	35.8
G25100-0604T	6G-4MP-TCX	7321-50915	3/8	9.5	1/4-18	5/8	2.32	58.9	1.22	31.0
G25100-0606T	6G-6MP-TCX	7321-50855	3/8	9.5	3/8-18	11/16	2.32	58.9	1.22	31.0
G25100-0608T	6G-8MP-TCX	7321-50945	3/8	9.5	1/2-14	7/8	2.51	63.8	1.42	36.1
G25100-0806T	8G-6MP-TCX	7321-50935	1/2	12.7	3/8-18	13/16	2.72	69.0	1.24	31.5
G25100-0808T	8G-8MP-TCX	7321-50845	1/2	12.7	1/2-14	7/8	2.87	73.0	1.40	35.5
G25100-0812T	8G-12MP-TCX	7321-50955	1/2	12.7	3/4-14	1 1/16	2.95	74.9	1.47	37.3
G25100-1008T	10G-8MP-TCX	7321-50995	5/8	15.9	1/2-14	15/16	2.95	75.0	1.48	37.5
G25100-1012T	10G-12MP-TCX	7321-51015	5/8	15.9	3/4-14	1 1/16	2.95	75.0	1.48	37.5
G25100-1208T	12G-8MP-TCX	7321-50985	3/4	19.1	1/2-14	1 1/16	3.46	87.9	1.45	36.8
G25100-1212T	12G-12MP-TCX	7321-50875	3/4	19.1	3/4-14	1 1/16	3.46	87.9	1.45	36.8
G25100-1216T	12G-16MP-TCX	7321-50975	3/4	19.1	1-11 1/2	1 3/8	3.77	95.8	1.77	45.0
G25100-1612T	16G-12MP-TCX	7321-51005	1	25.4	3/4-14	1 3/8	3.93	99.8	1.70	43.2
G25100-1616T	16G-16MP-TCX	7321-50895	1	25.4	1-11 1/2	1 3/8	4.11	104.4	1.87	47.5
G25100-2020T	20G-20MP-TCX	7321-50965	1 1/4	31.8	1 1/4-11 1/2	1 3/4	4.44	112.8	2.12	53.8

### Female Pipe (NPTF - without 30° Cone Seat)



Part No.	Descr.	Prod. No.	⊖		H1	L		C		
			"	mm		"	mm	"	mm	
G25110-0402T	4G-2FP-TCX	7321-51055	1/4	6.4	1/8-27	9/16	1.74	44.2	.72	18.3
G25110-0404T	4G-4FP-TCX	7321-51025	1/4	6.4	1/4-18	11/16	1.98	50.3	.96	24.4
G25110-0604T	6G-4FP-TCX	7321-50335	3/8	9.5	1/4-18	11/16	2.00	50.8	.90	22.9
G25110-0606T	6G-6FP-TCX	7321-51035	3/8	9.5	3/8-18	13/16	2.06	52.3	.96	24.4
G25110-0608T	6G-8FP-TCX	7321-51065	3/8	9.5	1/2-14	1	2.24	56.9	1.14	29.0
G25110-0806T	8G-6FP-TCX	7321-50385	1/2	12.7	3/8-18	13/16	2.46	62.5	.98	24.9
G25110-0808T	8G-8FP-TCX	7321-51045	1/2	12.7	1/2-14	1	2.63	66.8	1.16	29.5
G25110-1212T	12G-12FP-TCX	7321-51075	3/4	19.1	3/4-14	1.25	3.22	81.8	1.22	31.0



### Male JIC 37° Flare

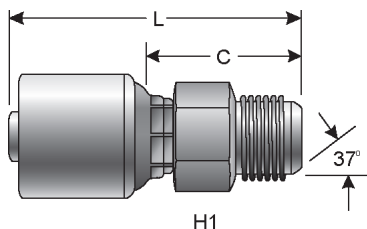

Part No.	Descr.	Prod. No.	⊖		H1	L		C		
			"	mm		"	mm	"	mm	
G25165-1212T	12G-12MJ-TCX	7321-52195	3/4	19.1	1 1/16-12	27	3.72	94.5	1.71	43.5

### Female JIC 37° Flare Swivel

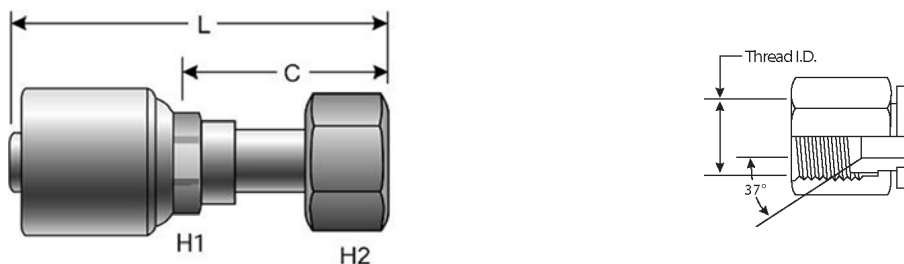

Part No.	Descr.	Prod. No.	⊖		H1	H2	L		C		
			"	mm			"	mm	"	mm	
G25170-0404T	4G-4FJX-TCX	7321-51105	1/4	6.4	7/16-20	15	14	2.20	55.9	1.18	29.9
G25170-0405T	4G-5FJX-TCX	7321-51215	1/4	6.4	1/2-20	15	17	2.30	58.3	1.27	32.3
G25170-0406T	4G-6FJX-TCX	7321-51135	1/4	6.4	9/16-18	15	19	2.35	59.6	1.32	33.6
G25170-0606T	6G-6FJX-TCX	7321-51085	3/8	9.5	9/16-18	18	19	2.42	61.5	1.29	32.7
G25170-0608T	6G-8FJX-TCX	7321-51125	3/8	9.5	3/4-16	18	24	2.63	66.7	1.49	37.9
G25170-0610T	6G-10FJX-TCX	7321-51205	3/8	9.5	7/8-14	18	27	2.76	70.0	1.62	41.2
G25170-0806T	8G-6FJX-TCX	7321-51225	1/2	12.7	9/16-18	22	19	3.81	96.7	2.33	59.2
G25170-0808T	8G-8FJX-TCX	7321-51095	1/2	12.7	3/4-16	22	24	2.88	73.2	1.50	38.0
G25170-0810T	8G-10FJX-TCX	7321-51145	1/2	12.7	7/8-14	22	27	3.01	76.5	1.63	41.3
G25170-0812T	8G-12FJX-TCX	7321-51185	1/2	12.7	1 1/16-12	22	32	3.06	77.7	1.67	42.5
G25170-1008T	10G-8FJX-TCX	7321-51255	5/8	15.9	3/4-16	24	24	4.06	103.0	2.58	65.5
G25170-1010T	10G-10FJX-TCX	7321-51165	5/8	15.9	7/8-14	24	27	3.14	79.7	1.66	42.2
G25170-1012T	10G-12FJX-TCX	7321-50535	5/8	15.9	1 1/16-12	24	32	3.20	81.4	1.73	43.9
G25170-1210T	12G-10FJX-TCX	7321-51235	3/4	19.1	7/8-14	27	27	4.80	122.0	2.80	71.0
G25170-1212T	12G-12FJX-TCX	7321-51115	3/4	19.1	1 1/16-12	30	32	3.74	95.0	1.73	44.0
G25170-1214T	12G-14FJX-TCX	7321-51295	3/4	19.1	1 3/16-12	30	36	3.81	96.9	1.81	45.9
G25170-1216T	12G-16FJX-TCX	7321-51195	3/4	19.1	1 5/16-12	30	41	3.85	97.9	1.85	46.9
G25170-1612T	16G-12FJX-TCX	7321-51245	1	25.4	1 1/16-12	36	32	5.89	149.5	3.65	92.7
G25170-1616T	16G-16FJX-TCX	7321-51155	1	25.4	1 5/16-12	36	41	4.24	107.8	2.01	51.0
G25170-1620T	16G-20FJX-TCX	7321-51305	1	25.4	1 5/8-12	36	50	4.54	115.3	2.30	58.5
G25170-2020T	20G-20FJX-TCX	7321-51175	1 1/4	31.8	1 5/8-12	41	50	4.42	112.3	2.09	53.3

EQUIPMENT
HOSE/CPLG. SELECTION
G8K COUPLINGS
GLOBALSPIRAL COUPLINGS
STAINLESS STEEL SPIRAL
MEGACRIMP COUPLINGS
STAINLESS STEEL BRAID
POWER CRIMP COUPLINGS
FIELD ATTACHABLE G1 & G2 COUPLINGS
FIELD ATTACHABLE C5 COUPLINGS
C14 COUPLINGS
GL COUPLINGS
GLX COUPLINGS
PCTS THERMOPLASTIC COUPLINGS
POLARSEAL COUPLINGS (ACA)
POLARSEAL II COUPLINGS (ACC)
POLARSEAL II COUPLINGS (ACB)
POWER STEERING
ADAPTERS
QUICK DISCONNECT COUPLERS
BALL VALVES
LIVE SWIVEL
ASSEMBLY FABRICATION
ACCESSORIES
EQUIPMENT AND PARTS
KITS
AIR BRAKE HOSE ASSY
BRASS





EQUIPMENT
HOSE/CPLG. SELECTION
G8K COUPLINGS
GLOBALSPIRAL COUPLINGS
STAINLESS STEEL SPIRAL
<b>MEGACRIMP COUPLINGS</b>
STAINLESS STEEL BRAID
POWER CRIMP COUPLINGS
FIELD ATTACHABLE G1 & G2 COUPLINGS
FIELD ATTACHABLE C5 COUPLINGS
C14 COUPLINGS
GL COUPLINGS
GLX COUPLINGS
PCTS THERMOPLASTIC COUPLINGS
POLARSEAL COUPLINGS (ACA)
POLARSEAL II COUPLINGS (ACC)
POLARSEAL II COUPLINGS (ACB)
POWER STEERING
ADAPTERS
QUICK DISCONNECT COUPLERS
BALL VALVES
LIVE SWIVEL
ASSEMBLY FABRICATION
ACCESSORIES
EQUIPMENT AND PARTS
KITS
AIR BRAKE HOSE ASSY
BRASS

### Female JIC 37° Flare Swivel - 45° Bent Tube

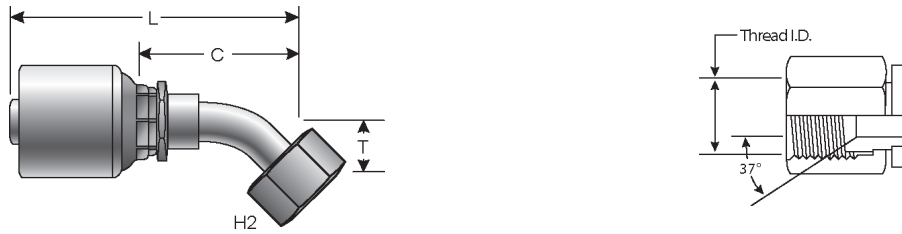

Part No.	Descr.	Prod. No.	⊖		H2	T		L		C		
			"	mm		"	mm	"	mm	"	mm	
G25174-0406T	4G-6FJX45S-TCX	7321-51375	1/4	6.4	9/16-18	19	.43	11.0	2.69	68.3	1.67	42.3
G25174-0606T	6G-6FJX45S-TCX	7321-51325	3/8	9.5	9/16-18	19	.43	11.0	3.05	77.5	1.95	49.6
G25174-0608T	6G-8FJX45S-TCX	7321-51385	3/8	9.5	3/4-16	24	.59	15.0	3.51	89.1	2.41	61.2
G25174-0808T	8G-8FJX45S-TCX	7321-51335	1/2	12.7	3/4-16	24	.59	15.0	3.42	86.9	1.95	49.5
G25174-0810T	8G-10FJX45S-TCX	7321-51365	1/2	12.7	7/8-14	27	.63	16.0	3.81	96.8	2.34	59.4
G25174-1010T	10G-10FJX45S-TCX	7321-51405	5/8	15.9	7/8-14	27	.63	16.0	3.80	96.4	2.32	59.0
G25174-1012T	10G-12FJX45S-TCX	7321-51415	5/8	15.9	1 1/16-12	32	.83	21.0	4.57	116.0	3.09	78.5
G25174-1212T	12G-12FJX45S-TCX	7321-51345	3/4	19.1	1 1/16-12	32	.83	21.0	5.09	129.2	3.08	78.2

### Female JIC 37° Flare Swivel - 90° Bent Tube

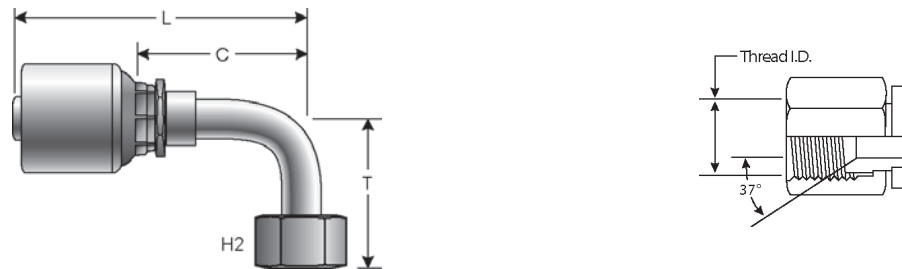

Part No.	Descr.	Prod. No.	⊖		H2	T		L		C		
			"	mm		"	mm	"	mm	"	mm	
G25180-0808T	8G-8FJX90M-TCX	7321-51735	1/2	12.7	3/4-16	24	1.61	40.1	3.04	77.2	1.30	33.0
G25180-1010T	10G-10FJX90M-TCX	7321-51745	5/8	15.9	7/8-14	27	1.86	47.2	3.63	92.2	2.15	54.6



### Female Flat-Face O-Ring Swivel

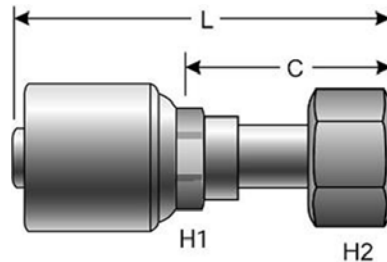

Part No.	Descr.	Prod. No.	⌀		H1	H2	L		C		
			"	mm			"	mm	"	mm	"
G25230-0404T	4G-4FFORX-TCX	7321-50305	1/4	6.4	9/16-18	15	17	2.07	52.7	1.05	26.7
G25230-0406T	4G-6FFORX-TCX	7321-50325	1/4	6.4	11/16-16	15	22	2.01	51.1	.99	25.1
G25230-0604T	6G-4FFORX-TCX	7321-50445	3/8	9.5	9/16-18	17	17	3.08	78.3	1.98	50.3
G25230-0606T	6G-6FFORX-TCX	7321-50015	3/8	9.5	11/16-16	18	22	2.27	57.7	1.14	28.9
G25230-0608T	6G-8FFORX-TCX	7321-50345	3/8	9.5	13/16-16	18	24	2.26	57.4	1.13	28.6
G25230-0806T	8G-6FFORX-TCX	7321-50375	1/2	12.7	11/16-16	22	22	3.78	95.9	2.30	58.4
G25230-0808T	8G-8FFORX-TCX	7321-50425	1/2	12.7	13/16-16	22	24	2.62	66.5	1.23	31.3
G25230-0810T	8G-10FFORX-TCX	7321-50755	1/2	12.7	1-14	22	30	2.76	70.0	1.37	34.8
G25230-0812T	8G-12FFORX-TCX	7321-50355	1/2	12.7	1 3/16-12	22	36	2.81	71.5	1.43	36.3
G25230-1010T	10G-10FFORX-TCX	7321-50545	5/8	15.9	1-14	24	30	2.99	76.0	1.52	38.5
G25230-1012T	10G-12FFORX-TCX	7321-50635	5/8	15.9	1 3/16-12	24	36	3.03	77.0	1.56	39.5
G25230-1210T	12G-10FFORX-TCX	7321-50125	3/4	19.1	1-14	30	30	3.74	95.1	1.74	44.1
G25230-1212T	12G-12FFORX-TCX	7321-50025	3/4	19.1	1 3/16-12	30	36	3.65	92.8	1.65	41.8
G25230-1216T	12G-16FFORX-TCX	7321-50465	3/4	19.1	1 7/16-12	30	41	3.48	88.3	1.47	37.3
G25230-1616T	16G-16FFORX-TCX	7321-50205	1	25.4	1 7/16-12	36	41	4.09	104.0	1.86	47.2
G25230-1620T	16G-20FFORX-TCX	7321-50215	1	25.4	1 11/16-12	36	50	4.06	103.0	1.82	46.2
G25230-2020T	20G-20FFORX-TCX	7321-50255	1 1/4	31.8	1 11/16-12	41	50	4.29	109.0	1.97	50.0

### Female Flat-Face O-Ring Swivel - 45° Bent Tube

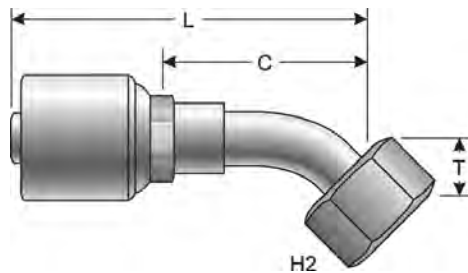

Part No.	Descr.	Prod. No.	⌀		H2	T		L		C		
			"	mm		"	mm	"	mm	"	mm	
G25235-0404T	4G-4FFORX45S-TCX	7321-50275	1/4	6.4	9/16-18	17	.39	10.0	2.57	65.2	1.54	39.2
G25235-0406T	4G-6FFORX45S-TCX	7321-50475	1/4	6.4	11/16-16	22	.43	11.0	2.70	68.5	1.67	42.5
G25235-0604T	6G-4FFORX45S-TCX	7321-50695	3/8	9.5	9/16-18	17	.39	10.0	2.60	66.1	1.50	38.1
G25235-0606T	6G-6FFORX45S-TCX	7321-50035	3/8	9.5	11/16-16	22	.43	11.0	2.75	69.8	1.65	41.9
G25235-0608T	6G-8FFORX45S-TCX	7321-50045	3/8	9.5	13/16-16	24	.59	15.0	3.35	85.2	2.26	57.3
G25235-0808T	8G-8FFORX45S-TCX	7321-50395	1/2	12.7	13/16-16	24	.59	15.0	3.50	89.0	2.03	51.6
G25235-0810T	8G-10FFORX45S-TCX	7321-50765	1/2	12.7	1-14	30	.63	16.0	3.98	101.0	2.50	63.5
G25235-1010T	10G-10FFORX45S-TCX	7321-50625	5/8	15.9	1-14	30	.63	16.0	3.96	100.5	2.48	63.0
G25235-1210T	12G-10FFORX45S-TCX	7321-50055	3/4	19.1	1-14	30	.63	16.0	4.45	113.0	2.44	62.0

EQUIPMENT
HOSE/CPLG. SELECTION
G8K COUPLINGS
GLOBALSPIRAL COUPLINGS
STAINLESS STEEL SPIRAL
MEGACRIMP COUPLINGS
STAINLESS STEEL BRAID
POWER CRIMP COUPLINGS
FIELD ATTACHABLE G1 & G2 COUPLINGS
FIELD ATTACHABLE C5 COUPLINGS
C14 COUPLINGS
GL COUPLINGS
GLX COUPLINGS
PCTS THERMOPLASTIC COUPLINGS
POLARSEAL COUPLINGS (ACA)
POLARSEAL II COUPLINGS (ACC)
POLARSEAL II COUPLINGS (ACB)
POWER STEERING
ADAPTERS
QUICK DISCONNECT COUPLERS
BALL VALVES
LIVE SWIVEL
ASSEMBLY FABRICATION
ACCESSORIES
EQUIPMENT AND PARTS
KITS
AIR BRAKE HOSE ASSY
BRASS



EQUIPMENT
HOSE/CPLG. SELECTION
G8K COUPLINGS
GLOBAL SPIRAL COUPLINGS
STAINLESS STEEL SPIRAL
MEGACRIMP COUPLINGS
STAINLESS STEEL BRAID
POWER CRIMP COUPLINGS
FIELD ATTACHABLE G1 & G2 COUPLINGS
FIELD ATTACHABLE C5 COUPLINGS
C14 COUPLINGS
GL COUPLINGS
GLX COUPLINGS
PCTS THERMOPLASTIC COUPLINGS
POLARSEAL COUPLINGS (ACA)
POLARSEAL II COUPLINGS (ACC)
POLARSEAL II COUPLINGS (ACB)
POWER STEERING
ADAPTERS
QUICK DISCONNECT COUPLERS
BALL VALVES
LIVE SWIVEL
ASSEMBLY FABRICATION
ACCESSORIES
EQUIPMENT AND PARTS
KITS
AIR BRAKE HOSE ASSY
BRASS

### Female Flat-Face O-Ring Swivel - 45° Bent Tube - Continued

Part No.	Descr.	Prod. No.	⊖			H2	T		L		C	
			"	mm	"	mm	"	mm	"	mm	"	mm
G25235-1212T	12G-12FFORX45S-TCX	7321-50065	3/4	19.1	1 3/16-12	36	.83	21.0	4.66	118.4	2.65	67.4
G25235-1216T	12G-16FFORX45S-TCX	7321-50585	3/4	19.1	1 7/16-12	41	.94	24.0	4.80	122.0	2.80	71.0
G25235-1616T	16G-16FFORX45S-TCX	7321-50165	1	25.4	1 7/16-12	41	.94	24.0	5.78	146.9	3.55	90.1
G25235-2020T	20G-20FFORX45S-TCX	7321-50225	1 1/4	31.8	1 11/16-12	50	.98	25.0	6.22	158.0	3.90	99.0

### Female Flat-Face O-Ring Swivel - 90° Bent Tube

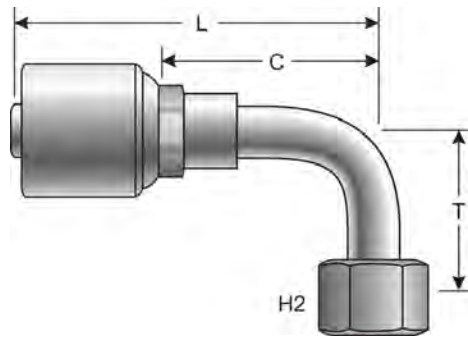

Part No.	Descr.	Prod. No.	⊖			H2	T		L		C	
			"	mm	"	mm	"	mm	"	mm	"	mm
G25239-0404T	4G-4FFORX90S-TCX	7321-50435	1/4	6.4	9/16-18	17	.83	21.0	2.37	60.2	1.35	34.2
G25239-0406T	4G-6FFORX90S-TCX	7321-50715	1/4	6.4	11/16-16	22	.91	23.0	2.50	63.4	1.47	37.4
G25239-0606T	6G-6FFORX90S-TCX	7321-50495	3/8	9.5	11/16-16	22	.91	23.0	2.85	72.5	1.76	44.6
G25239-0608T	6G-8FFORX90S-TCX	7321-50815	3/8	9.5	13/16-16	24	1.14	29.0	2.87	73.0	1.78	45.1
G25239-0808T	8G-8FFORX90S-TCX	7321-50645	1/2	12.7	13/16-16	24	1.14	29.0	3.30	83.9	1.83	46.5
G25239-0810T	8G-10FFORX90S-TCX	7321-50835	1/2	12.7	1-14	30	1.26	32.0	3.66	92.9	2.18	55.4
G25239-1010T	10G-10FFORX90S-TCX	7321-50725	5/8	15.9	1-14	30	1.26	32.0	3.64	92.5	2.17	55.0
G25239-1210T	12G-10FFORX90S-TCX	7321-50085	3/4	19.1	1-14	30	1.26	32.0	4.09	104.0	2.09	53.0
G25239-1212T	12G-12FFORX90S-TCX	7321-50075	3/4	19.1	1 3/16-12	36	1.89	48.0	4.28	108.8	2.28	57.8
G25239-1616T	16G-16FFORX90S-TCX	7321-50195	1	25.4	1 7/16-12	41	2.20	56.0	5.11	129.9	2.88	73.1
G25239-2020T	20G-20FFORX90S-TCX	7321-50245	1 1/4	31.8	1 11/16-12	50	2.52	64.0	5.91	150.0	3.58	91.0

### Code 61 O-Ring Flange

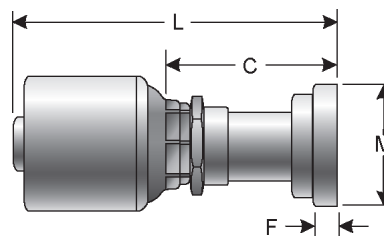

Part No.	Descr.	Prod. No.	⊖		M		L		C		F	
			"	mm	"	mm	"	mm	"	mm	"	mm
G25300-0808T	8G-8FL-TCX	7321-51575	1/2	12.7	1.19	30.2	3.15	80.0	1.67	42.5	.27	6.9



Code 61 O-Ring Flange - Continued

Part No.	Descr.	Prod. No.	⊖		M		L		C		F	
			"	mm	"	mm	"	mm	"	mm	"	mm
G25300-1212T	12G-12FL-TCX	7321-51555	3/4	19.1	1.50	38.1	3.86	98.0	1.85	47.0	.27	6.9
G25300-1216T	12G-16FL-TCX	7321-50005	3/4	19.1	1.75	44.5	3.50	88.8	1.49	37.8	.32	8.1
G25300-1616T	16G-16FL-TCX	7321-51565	1	25.4	1.75	44.5	4.13	105.0	1.90	48.2	.32	8.1

Code 61 O-Ring Flange - 90° Bent Tube

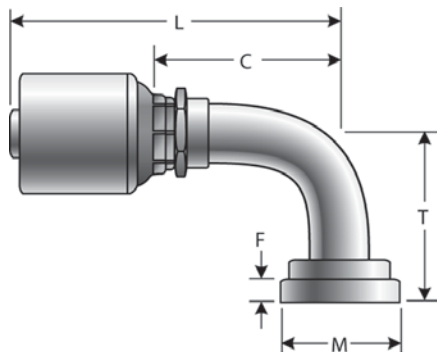

Part No.	Descr.	Prod. No.	⊖		M		T		L		C		F	
			"	mm	"	mm	"	mm	"	mm	"	mm	"	mm
G25315-1212T	12G-12FL90M-TCX	7321-50155	3/4	19.1	1.50	38.1	2.28	58.0	4.54	115.3	2.53	64.3	.27	6.9
G25314-2020T	20G-20FL90S-TCX	7321-50265	1 1/4	31.8	2.00	50.8	2.68	68.0	6.22	158.1	3.90	99.1	.32	8.1

- EQUIPMENT
- HOSE/CPLG. SELECTION
- G8K COUPLINGS
- GLOBALSPIRAL COUPLINGS
- STAINLESS STEEL SPIRAL
- MEGACRIMP COUPLINGS
- STAINLESS STEEL BRAID
- POWER CRIMP COUPLINGS
- FIELD ATTACHABLE G1 & G2 COUPLINGS
- FIELD ATTACHABLE C5 COUPLINGS
- C14 COUPLINGS
- GL COUPLINGS
- GLX COUPLINGS
- PCTS THERMOPLASTIC COUPLINGS
- POLARSEAL COUPLINGS (ACA)
- POLARSEAL II COUPLINGS (ACC)
- POLARSEAL II COUPLINGS (ACB)
- POWER STEERING
- ADAPTERS
- QUICK DISCONNECT COUPLERS
- BALL VALVES
- LIVE SWIVEL
- ASSEMBLY FABRICATION
- ACCESSORIES
- EQUIPMENT AND PARTS
- KITS
- AIR BRAKE HOSE ASSY
- BRASS



**NOTES**

EQUIPMENT
HOSE/CPLG. SELECTION
G8K COUPLINGS
GLOBAL SPIRAL COUPLINGS
STAINLESS STEEL SPIRAL
<b>MEGACRIMP COUPLINGS</b>
STAINLESS STEEL BRAID
POWER CRIMP COUPLINGS
FIELD ATTACHABLE G1 & G2 COUPLINGS
FIELD ATTACHABLE C5 COUPLINGS
C14 COUPLINGS
GL COUPLINGS
GLX COUPLINGS
PCTS THERMOPLASTIC COUPLINGS
POLARSEAL COUPLINGS (ACA)
POLARSEAL II COUPLINGS (ACC)
POLARSEAL II COUPLINGS (ACB)
POWER STEERING
ADAPTERS
QUICK DISCONNECT COUPLERS
BALL VALVES
LIVE SWIVEL
ASSEMBLY FABRICATION
ACCESSORIES
EQUIPMENT AND PARTS
KITS
AIR BRAKE HOSE ASSY
BRASS



# HYDRAULIC HOSE FOR STAINLESS STEEL BRAID COUPLINGS



Also available with MegaTuff® cover



Also available with MegaTuff® cover



Also available with MegaTuff® and XtraTuff® cover



Also available with MegaTuff® and XtraTuff® cover



Also available with MegaTuff® and XtraTuff® cover



Also available with MegaTuff® and XtraTuff® cover



EQUIPMENT
HOSE/CPLG. SELECTION
G8K COUPLINGS
GLOBALSPIRAL COUPLINGS
STAINLESS STEEL SPIRAL
MEGACRIMP COUPLINGS
STAINLESS STEEL BRAID
POWER CRIMP COUPLINGS
FIELD ATTACHABLE G1 & G2 COUPLINGS
FIELD ATTACHABLE C5 COUPLINGS
C14 COUPLINGS
GL COUPLINGS
GLX COUPLINGS
PCTS THERMOPLASTIC COUPLINGS
POLARSEAL COUPLINGS (ACA)
POLARSEAL II COUPLINGS (ACC)
POLARSEAL II COUPLINGS (ACB)
POWER STEERING
ADAPTERS
QUICK DISCONNECT COUPLERS
BALL VALVES
LIVE SWIVEL
ASSEMBLY FABRICATION
ACCESSORIES
EQUIPMENT AND PARTS
KITS
AIR BRAKE HOSE ASSY
BRASS



## HYDRAULIC HOSE FOR STAINLESS STEEL BRAID COUPLINGS - CONTINUED



EQUIPMENT
HOSE/CPLG. SELECTION
G8K COUPLINGS
GLOBAL SPIRAL COUPLINGS
STAINLESS STEEL SPIRAL
MEGACRIMP COUPLINGS
STAINLESS STEEL BRAID
POWER CRIMP COUPLINGS
FIELD ATTACHABLE G1 & G2 COUPLINGS
FIELD ATTACHABLE C5 COUPLINGS
C14 COUPLINGS
GL COUPLINGS
GLX COUPLINGS
PCTS THERMOPLASTIC COUPLINGS
POLARSEAL COUPLINGS (ACA)
POLARSEAL II COUPLINGS (ACC)
POLARSEAL II COUPLINGS (ACB)
POWER STEERING
ADAPTERS
QUICK DISCONNECT COUPLERS
BALL VALVES
LIVE SWIVEL
ASSEMBLY FABRICATION
ACCESSORIES
EQUIPMENT AND PARTS
KITS
AIR BRAKE HOSE ASSY
BRASS

**The Gates eCrimp program** is a web based utility which allows users and distributors of Gates hydraulic and industrial hose products to find and print the most up to date crimp specifications with nothing more than an internet browser.

This program can be used to find crimp data for all Gates crimpers. Custom result may be printed by selecting the crimper, hose and coupling. Optionally results may also be limited by die set and working pressure.

The eCrimp web application can be directly accessed from a web browser by entering <http://eCrimp.Gates.com> for the website.

**The eCrimp mobile app** is available for download for the iPhone and iPad from the App Store.





### Male Pipe (NPTF - 30° Cone Seat)

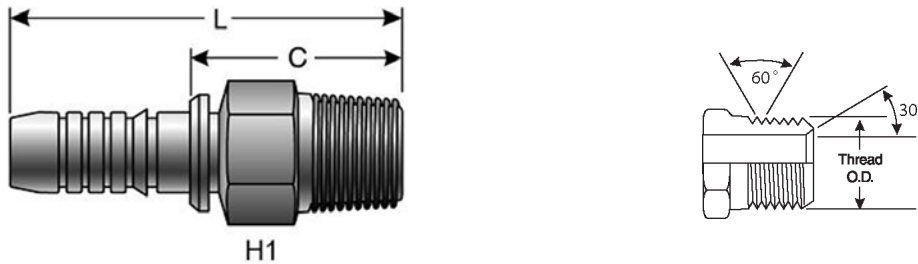

Part No.	Descr.	Prod. No.	⌀		"	H1		L		C	
			"	mm		"	"	mm	"	mm	"
G17100-0404	4B-4MP-SS	7362-00245	1/4	6.4	1/4-18	.56	14.3	2.16	54.9	1.14	29.0
G17100-0606	6B-6MP-SS	7362-00275	3/8	9.5	3/8-18	.68	17.5	2.32	58.9	1.22	31.0
G17100-0808	8B-8MP-SS	7362-00295	1/2	12.7	1/2-14	.88	22.4	2.89	73.4	1.46	37.1
G17100-1212	12B-12MP-SS	7362-00325	3/4	19.1	3/4-14	1.06	27	3.21	81.5	1.51	38.4
G17100-1616	16B-16MP-SS	7362-00355	1	25.4	1-11 1/2	1.38	35	3.62	91.9	1.91	48.6
G17100-2020	20B-20MP-SS	7362-00385	1 1/4	31.8	1 1/4-11 1/2	1.75	44.5	4.44	113.0	2.14	54.6
G17100-2424	24B-24MP-SS	7362-00405	1 1/2	38.1	1 1/2-11 1/2	2	50.8	5.24	133.1	2.34	59.4
G17100-3232	32B-32MP-SS	7362-00425	2	50.8	2-11 1/2	2.50	63.5	6.05	153.7	2.43	61.7

### Female JIC 37° Flare Swivel

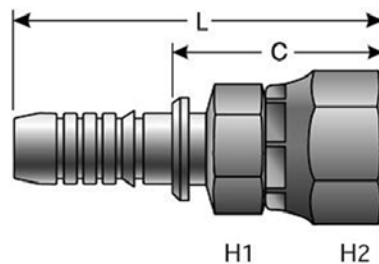

Part No.	Descr.	Prod. No.	⌀		"	H1		H2		L		C	
			"	mm		"	"	mm	"	mm	"	mm	"
G17170-0606	6B-6FJX-SS	7362-01225	3/8	9.5	9/16-18	.62	15.8	.75	19.1	2.35	59.7	1.26	31.8
G17170-1212	12B-12FJX-SS	7362-01315	3/4	19.1	1 1/16-12	1.06	26.9	1.25	31.8	3.41	86.6	1.71	43.4
G17170-1616	16B-16FJX-SS	7362-01375	1	25.4	1 5/16-12	1.37	34.8	1.50	38.1	3.66	92.9	1.95	49.5
G17170-2020	20B-20FJX-SS	7362-01405	1 1/4	31.8	1 5/8-12	1.88	47.6	2	50.8	4.72	119.9	2.42	61.5
G17170-2424	24B-24FJX-SS	7362-01435	1 1/2	38.1	1 7/8-12	2	50.8	2.25	57.2	5.39	136.9	2.50	63.5
G17170-3232	32B-32FJX-SS	7362-01465	2	50.8	2 1/2-12	2.75	69.9	3	76.2	6.48	164.6	2.86	72.6

- EQUIPMENT
- HOSE/CPLG. SELECTION
- G8K COUPLINGS
- GLOBALSPIRAL COUPLINGS
- STAINLESS STEEL SPIRAL
- MEGACRIMP COUPLINGS
- STAINLESS STEEL BRAID
- POWER CRIMP COUPLINGS
- FIELD ATTACHABLE G1 & G2 COUPLINGS
- FIELD ATTACHABLE C5 COUPLINGS
- C14 COUPLINGS
- GL COUPLINGS
- GLX COUPLINGS
- PCTS THERMOPLASTIC COUPLINGS
- POLARSEAL COUPLINGS (ACA)
- POLARSEAL II COUPLINGS (ACC)
- POLARSEAL II COUPLINGS (ACB)
- POWER STEERING
- ADAPTERS
- QUICK DISCONNECT COUPLERS
- BALL VALVES
- LIVE SWIVEL
- ASSEMBLY FABRICATION
- ACCESSORIES
- EQUIPMENT AND PARTS
- KITS
- AIR BRAKE HOSE ASSY
- BRASS



EQUIPMENT
HOSE/CPLG. SELECTION
G8K COUPLINGS
GLOBALSPIRAL COUPLINGS
STAINLESS STEEL SPIRAL
MEGACRIMP COUPLINGS
STAINLESS STEEL BRAID
POWER CRIMP COUPLINGS
FIELD ATTACHABLE G1 & G2 COUPLINGS
FIELD ATTACHABLE C5 COUPLINGS
C14 COUPLINGS
GL COUPLINGS
GLX COUPLINGS
PCTS THERMOPLASTIC COUPLINGS
POLARSEAL COUPLINGS (ACA)
POLARSEAL II COUPLINGS (ACC)
POLARSEAL II COUPLINGS (ACB)
POWER STEERING
ADAPTERS
QUICK DISCONNECT COUPLERS
BALL VALVES
LIVE SWIVEL
ASSEMBLY FABRICATION
ACCESSORIES
EQUIPMENT AND PARTS
KITS
AIR BRAKE HOSE ASSY
BRASS

### Female JIC 37° Flare Swivel - 45° Bent Tube

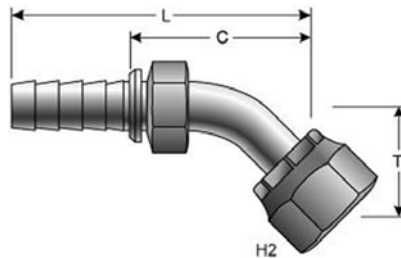

Part No.	Descr.	Prod. No.	⊖		🌀		H2		T		L		C	
			"	mm	"	"	mm	"	mm	"	mm	"	mm	"
G17174-0606	6B-6FJX45S-SS	7362-11235	3/8	9.5	9/16-18	.75	19.1	.43	11.0	2.94	74.6	1.84	46.7	
G17174-1212	12B-12FJX45S-SS	7362-11345	3/4	19.1	1 1/16-12	1.25	31.8	.83	21.0	5.27	133.8	3.56	90.4	
G17174-1616	16B-16FJX45S-SS	7362-11385	1	25.4	1 5/16-12	1.50	38.1	.94	23.9	5.06	128.5	3.36	85.3	

### Female JIC 37° Flare Swivel - 90° Bent Tube

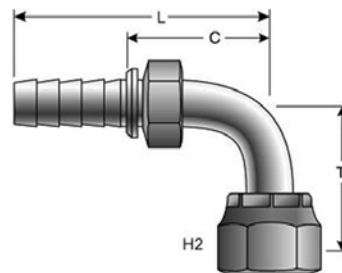

Part No.	Descr.	Prod. No.	⊖		🌀		H2		T		L		C	
			"	mm	"	"	mm	"	mm	"	mm	"	mm	"
G17180-0606	6B-6FJX90M-SS	7362-21265	3/8	9.5	9/16-18	.75	19.1	1.50	38.0	2.13	54.1	1.03	26.2	
G17179-1212	12B-12FJX90S-SS	7362-21445	3/4	19.1	1 1/16-12	1.25	31.8	1.89	48.0	4.20	106.7	2.50	63.5	
G17180-1212	12B-12FJX90M-SS	7362-21455	3/4	19.1	1 1/16-12	1.25	31.8	2.28	57.9	3.81	96.8	2.11	53.5	
G17180-1616	16B-16FJX90M-SS	7362-21555	1	25.4	1 5/16-12	1.50	38.1	2.80	71.0	4.37	110.9	2.66	67.6	

### Female SAE 45° Flare Swivel

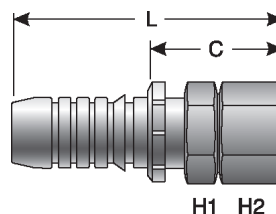

Part No.	Descr.	Prod. No.	⊖		🌀		H1		H2		L		C	
			"	mm	"	"	mm	"	mm	"	mm	"	mm	"
G17200-1212	12B-12FSX-SS	7362-01335	3/4	19.1	1 1/16-14	1.06	26.9	1.25	31.8	3.41	86.6	1.71	43.4	



### Dual Seat Female JIC 37°/SAE 45° Flare Swivel

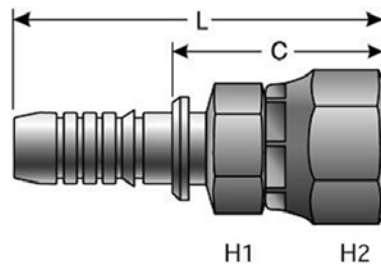

Part No.	Descr.	Prod. No.	⊖		🌀	H1		H2		L		C	
			"	mm		"	mm	"	mm	"	mm	"	mm
G17210-0404	4B-4FJSX-SS	7362-01205	1/4	6.4	7/16-20	.50	12.7	.56	14.2	2.24	57.0	1.21	30.9
G17210-0808	8B-8FJSX-SS	7362-01265	1/2	12.7	3/4-16	.81	20.6	.87	22.1	2.82	71.6	1.38	35.1
G17210-1010	10B-10FJSX-SS	7362-01285	5/8	15.9	7/8-14	.93	23.6	1.06	26.9	3.06	77.7	1.61	41.4

### Dual Seat Female JIC 37°/SAE 45° Flare Swivel - 45° Bent Tube

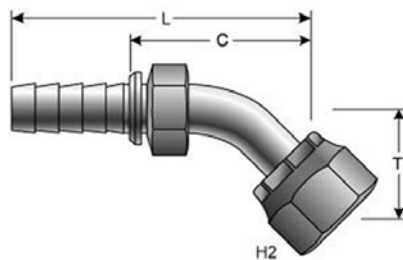

Part No.	Descr.	Prod. No.	⊖		🌀	H2		T		L		C	
			"	mm		"	mm	"	mm	"	mm	"	mm
G17211-0404	4B-4FJSX45S-SS	7362-11205	1/4	6.4	7/16-20	.56	14.2	.39	10.0	2.59	65.7	1.56	39.6
G17211-0808	8B-8FJSX45S-SS	7362-11285	1/2	12.7	3/4-16	.88	22.4	.59	15.0	3.65	92.7	2.22	56.4
G17211-1010	10B-10FJSX45S-SS	7362-11305	5/8	15.9	7/8-14	1.06	26.9	.63	16.0	4.04	102.6	2.60	66.1

### Dual Seat Female JIC 37°/SAE 45° Flare Swivel - 90° Bent Tube

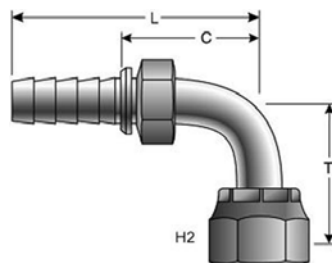

Part No.	Descr.	Prod. No.	⊖		🌀	H2		T		L		C	
			"	mm		"	mm	"	mm	"	mm	"	mm
G17212-0404	4B-4FJSX90S-SS	7362-21205	1/4	6.4	7/16-20	.56	14.2	.83	21.1	2.08	52.8	1.06	26.9

EQUIPMENT
HOSE/CPLG. SELECTION
G8K COUPLINGS
GLOBALSPIRAL COUPLINGS
STAINLESS STEEL SPIRAL
MEGACRIMP COUPLINGS
STAINLESS STEEL BRAID
POWER CRIMP COUPLINGS
FIELD ATTACHABLE G1 & G2 COUPLINGS
FIELD ATTACHABLE C5 COUPLINGS
C14 COUPLINGS
GL COUPLINGS
GLX COUPLINGS
PCTS THERMOPLASTIC COUPLINGS
POLARSEAL COUPLINGS (ACA)
POLARSEAL II COUPLINGS (ACC)
POLARSEAL II COUPLINGS (ACB)
POWER STEERING
ADAPTERS
QUICK DISCONNECT COUPLERS
BALL VALVES
LIVE SWIVEL
ASSEMBLY FABRICATION
ACCESSORIES
EQUIPMENT AND PARTS
KITS
AIR BRAKE HOSE ASSY
BRASS



Dual Seat Female JIC 37°/SAE 45° Flare Swivel - 90° Bent Tube - Continued

Part No.	Descr.	Prod. No.	⊖		🌀		H2		T		L		C	
			"	mm	"	"	mm	"	mm	"	mm	"	mm	
G17213-0404	4B-4FJSX90M-SS	7362-21215	1/4	6.4	7/16-20	.56	14.2	1.26	32.0	1.92	48.8	.90	22.9	
G17212-0808	8B-8FJSX90S-SS	7362-21345	1/2	12.7	3/4-16	.87	22.1	1.14	29.0	3.30	83.8	1.87	47.5	
G17213-0808	8B-8FJSX90M-SS	7362-21355	1/2	12.7	3/4-16	.87	22.1	1.61	41.0	2.83	72.0	1.40	35.6	
G17212-1010	10B-10FJSX90S-SS	7362-21395	5/8	15.9	7/8-14	1.06	26.9	1.26	32.0	3.37	85.7	1.93	49.1	
G17213-1010	10B-10FJSX90M-SS	7362-21405	5/8	15.9	7/8-14	1.06	26.9	1.85	47.0	3.06	77.7	1.62	41.2	

Female Flat-Face O-Ring Swivel Metric Hex

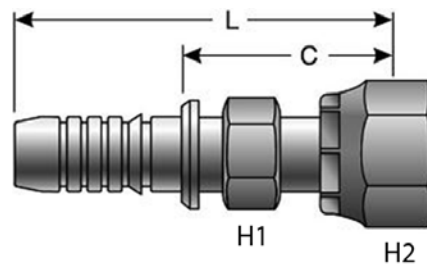

Part No.	Descr.	Prod. No.	⊖		🌀		H1		H2		L		C	
			"	mm	"	"	mm	"	mm	"	mm	"	mm	
G17230-0404	4B-4FFORX-SS	7362-03045	1/4	6.4	9/16-18	.55	14	.67	17	2.14	54.5	1.11	28.4	
G17230-0808	8B-8FFORX-SS	7362-03085	1/2	12.7	13/16-16	.87	22.2	.87	24	2.89	73.4	1.46	37.1	
G17230-1010	10B-10FFORX-SS	7362-03105	5/8	15.9	1-14	.94	24	1.18	30	3.09	78.5	1.66	42.1	
G17230-1212	12B-12FFORX-SS	7362-03125	3/4	19.1	1 3/16-12	1.18	30	1.42	36	3.42	87.0	1.72	43.7	
G17230-1616	16B-16FFORX-SS	7362-03145	1	25.4	1 7/16-12	1.42	36	1.61	40.9	3.97	101.0	2.27	57.7	
G17230-2020	20B-20FFORX-SS	7362-03165	1 1/4	31.8	1 11/16-12	1.81	46	1.97	41	4.88	124.0	2.58	65.6	
G17230-2424	24B-24FFORX-SS	7362-03185	1 1/2	38.1	2-12	1.97	50	2.36	60	5.51	140.0	2.61	66.4	

Code 61 O-Ring Flange

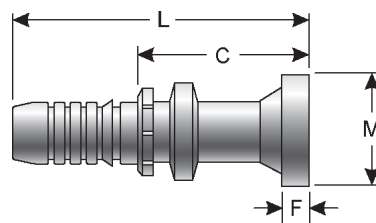

Part No.	Descr.	Prod. No.	⊖		M		L		C		F	
			"	mm	"	mm	"	mm	"	mm	"	mm
G17300-2424	24B-24FL-SS	7362-04475	1 1/2	38.1	2.38	60.5	5.89	149.6	2.99	75.9	.32	8.1
G17300-3232	32B-32FL-SS	7362-04205	2	50.8	2.81	71.4	6.27	159.3	2.65	67.3	.38	9.7



## Female DIN 24° Cone Swivel - Heavy Series with O-Ring

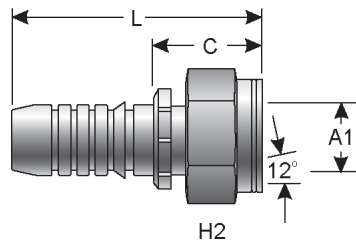

Part No.	Descr.	Prod. No.	⊖		H2	L		C		A1	
			"	mm		"	mm	"	mm		
G17720-0410	4B-10FDHORX-SS	7362-91665	1/4	6.4	M18X1.5	22	2.24	57.0	1.22	31.0	10.0
G17720-0612	6B-12FDHORX-SS	7362-91965	3/4	19.1	M20X1.5	—	—	—	—	—	12.0
G17720-0816	8B-16FDHORX-SS	7362-91725	1/2	12.7	M24X1.5	30	2.80	71.0	1.36	34.5	16.0
G17720-1220	12B-20FDHORX-SS	7362-91755	3/4	19.1	M30X2.0	36	3.23	82.0	1.52	38.6	20.0
G17720-1625	16B-25FDHORX-SS	7362-91775	1	25.4	M36X2.0	41	3.62	92.0	1.92	48.7	25.0
G17720-1630	16B-30FDHORX-SS	7362-91785	1	25.4	M42X2.0	50	3.72	94.5	2.02	51.3	30.0
G17720-2038	20B-38FDHORX-SS	7362-91795	1 1/4	31.8	M52X2.0	60	4.84	123.0	2.54	64.5	38.0
G17720-2438	24B-38FDHORX-SS	7362-91805	1 1/4	31.8	M52X2.0	60	5.57	141.5	2.67	67.8	38.0

## Non-Skive Ferrule

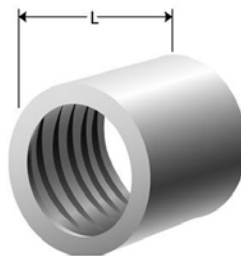

Part No.	Descr.	Prod. No.	⊖		L	
			"	mm	"	mm
G17995-0104	4B1F-1SS	7362-51305	1/4	6.4	1.25	31.8
G17995-0106	6B1F-1SS	7362-51425	3/8	9.5	1.20	30.5
G17995-0204	4B1F-2SS	7362-51415	1/4	6.4	1.04	26.3
G17995-0206	6B1F-2SS	7362-51435	3/8	9.5	1.20	30.5
G17995-0208	8B1F-1SS	7362-51465	1/2	12.7	1.47	37.3
G17995-0210	10B1F-1SS	7362-51475	5/8	15.9	1.47	37.3
G17995-0212D	12B1F-2SS	7362-51565	3/4	19.1	1.65	42.0
G17995-0212	12B1F-1SS	7362-51505	3/4	19.1	1.69	42.9
G17995-0216D	16B1F-2SS	7362-51885	1	25.4	1.97	50.0
G17995-0216	16B1F-3SS	7362-51865	1	25.4	1.69	43.0
G17995-0220	20B1F-1SS	7362-51545	1 1/4	31.8	2.41	61.2
G17995-0224	24B1F-2SS	7362-51665	1 1/2	38.1	2.98	75.8
G17995-0232	32B1F-2SS	7362-51705	2	50.8	3.54	90.0
G17995-0424	24B1F-4SS	7362-51675	1 1/2	38.1	3.01	76.5
G17995-0432	32B1F-4SS	7362-51725	2	50.8	3.58	91.0

EQUIPMENT
HOSE/CPLG. SELECTION
G8K COUPLINGS
GLOBALSPIRAL COUPLINGS
STAINLESS STEEL SPIRAL
MEGACRIMP COUPLINGS
STAINLESS STEEL BRAID
POWER CRIMP COUPLINGS
FIELD ATTACHABLE G1 & G2 COUPLINGS
FIELD ATTACHABLE C5 COUPLINGS
C14 COUPLINGS
GL COUPLINGS
GLX COUPLINGS
PCTS THERMOPLASTIC COUPLINGS
POLARSEAL COUPLINGS (ACA)
POLARSEAL II COUPLINGS (ACC)
POLARSEAL II COUPLINGS (ACB)
POWER STEERING
ADAPTERS
QUICK DISCONNECT COUPLERS
BALL VALVES
LIVE SWIVEL
ASSEMBLY FABRICATION
ACCESSORIES
EQUIPMENT AND PARTS
KITS
AIR BRAKE HOSE ASSY
BRASS



**NOTES**

EQUIPMENT
HOSE/CPLG. SELECTION
G8K COUPLINGS
GLOBAL SPIRAL COUPLINGS
STAINLESS STEEL SPIRAL
MEGACRIMP COUPLINGS
STAINLESS STEEL BRAID
POWER CRIMP COUPLINGS
FIELD ATTACHABLE G1 & G2 COUPLINGS
FIELD ATTACHABLE C5 COUPLINGS
C14 COUPLINGS
GL COUPLINGS
GLX COUPLINGS
PCTS THERMOPLASTIC COUPLINGS
POLARSEAL COUPLINGS (ACA)
POLARSEAL II COUPLINGS (ACC)
POLARSEAL II COUPLINGS (ACB)
POWER STEERING
ADAPTERS
QUICK DISCONNECT COUPLERS
BALL VALVES
LIVE SWIVEL
ASSEMBLY FABRICATION
ACCESSORIES
EQUIPMENT AND PARTS
KITS
AIR BRAKE HOSE ASSY
BRASS



# HYDRAULIC HOSE FOR POWER CRIMP® COUPLINGS



Also available with MegaTuff® and XtraTuff® cover



**The Gates eCrimp program** is a web based utility which allows users and distributors of Gates hydraulic and industrial hose products to find and print the most up to date crimp specifications with nothing more than an internet browser.

This program can be used to find crimp data for all Gates crimpers. Custom result may be printed by selecting the crimper, hose and coupling. Optionally results may also be limited by die set and working pressure.

The eCrimp web application can be directly accessed from a web browser by entering <http://eCrimp.Gates.com> for the website.

**The eCrimp mobile app** is available for download for the iPhone and iPad from the App Store.

EQUIPMENT
HOSE/CPLG. SELECTION
G8K COUPLINGS
GLOBALSPIRAL COUPLINGS
STAINLESS STEEL SPIRAL
MEGACRIMP COUPLINGS
STAINLESS STEEL BRAID
<b>POWER CRIMP COUPLINGS</b>
FIELD ATTACHABLE G1 & G2 COUPLINGS
FIELD ATTACHABLE C5 COUPLINGS
C14 COUPLINGS
GL COUPLINGS
GLX COUPLINGS
PCTS THERMOPLASTIC COUPLINGS
POLARSEAL COUPLINGS (ACA)
POLARSEAL II COUPLINGS (ACC)
POLARSEAL II COUPLINGS (ACB)
POWER STEERING
ADAPTERS
QUICK DISCONNECT COUPLERS
BALL VALVES
LIVE SWIVEL
ASSEMBLY FABRICATION
ACCESSORIES
EQUIPMENT AND PARTS
KITS
AIR BRAKE HOSE ASSY
BRASS





EQUIPMENT
HOSE/CPLG. SELECTION
G8K COUPLINGS
GLOBALSPIRAL COUPLINGS
STAINLESS STEEL SPIRAL
MEGACRIMP COUPLINGS
STAINLESS STEEL BRAID
<b>POWER CRIMP COUPLINGS</b>
FIELD ATTACHABLE G1 & G2 COUPLINGS
FIELD ATTACHABLE C5 COUPLINGS
C14 COUPLINGS
GL COUPLINGS
GLX COUPLINGS
PCTS THERMOPLASTIC COUPLINGS
POLARSEAL COUPLINGS (ACA)
POLARSEAL II COUPLINGS (ACC)
POLARSEAL II COUPLINGS (ACB)
POWER STEERING
ADAPTERS
QUICK DISCONNECT COUPLERS
BALL VALVES
LIVE SWIVEL
ASSEMBLY FABRICATION
ACCESSORIES
EQUIPMENT AND PARTS
KITS
AIR BRAKE HOSE ASSY
BRASS

### Male Pipe (NPTF - 30° Cone Seat)

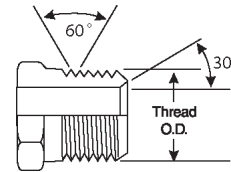
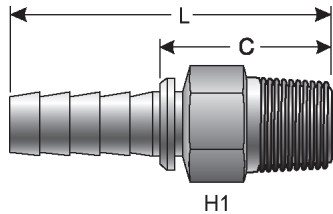

Part No.	Descr.	Prod. No.	⊖		H1	L		C		
			"	mm		"	mm	"	mm	
80001	3-2MP	7334-36215	3/16	4.8	1/8-27	1/2	2.03	51.6	.94	23.9
80002	3-4MP	7334-36245	3/16	4.8	1/4-18	9/16	2.22	56.4	1.13	28.7
80004	4-4MP	7301-09145	1/4	6.4	1/4-18	9/16	2.22	56.4	1.13	28.7
80007	5-4MP	7301-19145	5/16	7.9	1/4-18	5/8	2.19	55.6	1.18	30.0
80009	6-6MP	7306-29145	3/8	9.5	3/8-18	11/16	2.22	56.4	1.20	30.5
80011	6-8MP	7306-29165	3/8	9.5	1/2-14	7/8	2.41	61.2	1.39	35.3
80012	8-6MP	7301-39125	1/2	12.7	3/8-18	13/16	2.70	68.6	1.26	32.0
80013	8-8MP	7301-39145	1/2	12.7	1/2-14	7/8	2.89	73.4	1.45	36.8
80018	12-12MP	7301-59145	3/4	19.1	3/4-14	1 1/16	3.21	81.5	1.50	38.1
80023	16-16MP	7301-69145	1	25.4	1-11 1/2	1 3/8	3.62	92.0	1.91	48.5
80025	24-24MP	7301-89145	1 1/2	38.1	1 1/2-11 1/2	2	4.83	122.7	2.19	55.6
80026	32-32MP	7301-99145	2	50.8	2-11 1/2	2 1/2	5.86	148.8	2.33	59.2

### Male Special Grease Fitting

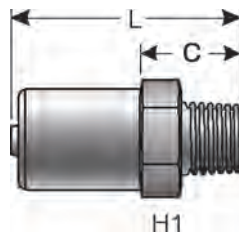

Part No.	Descr.	Prod. No.	⊖		H1	L		C		
			"	mm		"	mm	"	mm	
80120	3-2MPG	7334-32445	3/16	4.8	1/8-27	9/16	1.34	34.0	.56	14.2
△ 80140	3-2MPGB	7334-37925	3/16	4.8	1/8-27	9/16	1.34	34.0	.78	19.8

△ WARNING: Cancer and Reproductive Harm - www.P65Warnings.ca.gov



### Male Pipe Swivel (NPTF - without 30° Cone Seat)

NOT TO BE USED AS A LIVE SWIVEL.

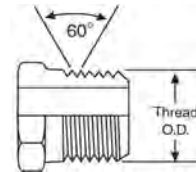
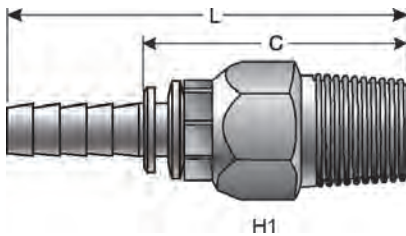

Part No.	Descr.	Prod. No.	⊖		H1	L		C		
			"	mm		"	"	"	mm	"
80031	3-2MPX	7334-36335	3/16	4.8	1/8-27	1/2	2.40	61.0	1.31	33.3
80039	8-8MPX	7302-39145	1/2	12.7	1/2-14	13/16	3.38	85.9	1.94	49.3

### Female Pipe (NPTF - without 30° Cone Seat)

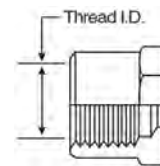
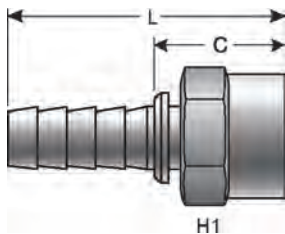

Part No.	Descr.	Prod. No.	⊖		H1	L		C		
			"	mm		"	"	"	mm	"
80061	3-2FP	7334-36225	3/16	4.8	1/8-27	9/16	1.85	47.0	.76	19.3

### Male JIC 37° Flare

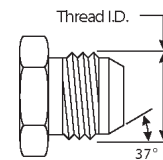
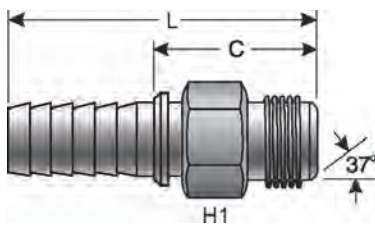

Part No.	Descr.	Prod. No.	⊖		H1	L		C		
			"	mm		"	"	"	mm	"
80181	3-4MJ	7334-36235	3/16	4.8	7/16-20	1/2	2.09	53.1	1.00	25.4

- EQUIPMENT
- HOSE/CPLG. SELECTION
- G8K COUPLINGS
- GLOBALSPIRAL COUPLINGS
- STAINLESS STEEL SPIRAL
- MEGACRIMP COUPLINGS
- STAINLESS STEEL BRAID
- POWER CRIMP COUPLINGS**
- FIELD ATTACHABLE G1 & G2 COUPLINGS
- FIELD ATTACHABLE C5 COUPLINGS
- C14 COUPLINGS
- GL COUPLINGS
- GLX COUPLINGS
- PCTS THERMOPLASTIC COUPLINGS
- POLARSEAL COUPLINGS (ACA)
- POLARSEAL II COUPLINGS (ACC)
- POLARSEAL II COUPLINGS (ACB)
- POWER STEERING
- ADAPTERS
- QUICK DISCONNECT COUPLERS
- BALL VALVES
- LIVE SWIVEL
- ASSEMBLY FABRICATION
- ACCESSORIES
- EQUIPMENT AND PARTS
- KITS
- AIR BRAKE HOSE ASSY
- BRASS



EQUIPMENT
HOSE/CPLG. SELECTION
G8K COUPLINGS
GLOBAL SPIRAL COUPLINGS
STAINLESS STEEL SPIRAL
MEGACRIMP COUPLINGS
STAINLESS STEEL BRAID
<b>POWER CRIMP COUPLINGS</b>
FIELD ATTACHABLE G1 & G2 COUPLINGS
FIELD ATTACHABLE C5 COUPLINGS
C14 COUPLINGS
GL COUPLINGS
GLX COUPLINGS
PCTS THERMOPLASTIC COUPLINGS
POLARSEAL COUPLINGS (ACA)
POLARSEAL II COUPLINGS (ACC)
POLARSEAL II COUPLINGS (ACB)
POWER STEERING
ADAPTERS
QUICK DISCONNECT COUPLERS
BALL VALVES
LIVE SWIVEL
ASSEMBLY FABRICATION
ACCESSORIES
EQUIPMENT AND PARTS
KITS
AIR BRAKE HOSE ASSY
BRASS

### Female JIC 37° Flare Swivel

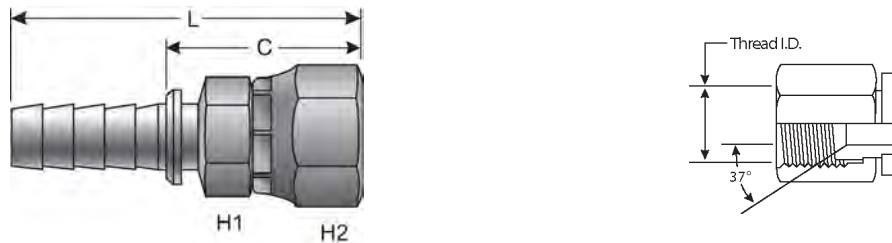

Part No.	Descr.	Prod. No.	⊖		🌀	H1	H2	L		C	
			"	mm				"	mm	"	mm
80131	3-3FJX	7334-36315	3/16	4.8	3/8-24	1/2	9/16	2.20	55.9	1.11	28.2
80132	3-4FJX	7334-36325	3/16	4.8	7/16-20	1/2	9/16	2.21	56.1	1.12	28.5
80134	4-4FJX	7303-09245	1/4	6.4	7/16-20	1/2	9/16	2.13	54.1	1.04	26.4
80135	4-5FJX	7303-09265	1/4	6.4	1/2-20	1/2	11/16	2.28	57.9	1.18	30.0
80136	4-6FJX	7303-09285	1/4	6.4	9/16-18	9/16	3/4	2.28	57.9	1.18	30.0
80137	5-5FJX	7303-19245	5/16	7.9	1/2-20	5/8	11/16	2.25	57.2	1.23	31.2
80138	5-6FJX	7303-19265	5/16	7.9	9/16-18	5/8	3/4	2.24	56.9	1.22	31.0
80139	6-6FJX	7308-29245	3/8	9.5	9/16-18	5/8	3/4	2.24	56.9	1.22	31.0
80141	6-8FJX	7308-29265	3/8	9.5	3/4-16	11/16	7/8	2.35	59.7	1.33	33.8
80143	8-8FJX	7303-39245	1/2	12.7	3/4-16	13/16	7/8	2.76	70.1	1.32	33.5
80144	8-10FJX	7303-39265	1/2	12.7	7/8-14	13/16	1 1/16	2.98	75.7	1.54	39.1
80147	10-10FJX	7303-49245	5/8	15.9	7/8-14	7/8	1 1/16	3.04	77.2	1.60	40.6
80148	10-12FJX	7303-49265	5/8	15.9	1 1/16-12	1	1 1/4	3.12	79.3	1.68	42.7
80152	12-12FJX	7303-59245	3/4	19.1	1 1/16-12	1 1/16	1 1/4	3.39	86.1	1.68	42.7
80158	16-16FJX	7303-69245	1	25.4	1 5/16-12	1 3/8	1 1/2	3.63	92.2	1.92	48.8

### Female JIC 37° Flare Swivel - 45° Bent Tube

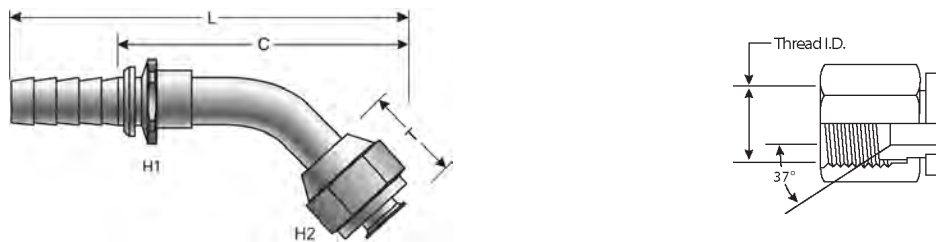

Part No.	Descr.	Prod. No.	⊖		🌀	H1	H2	T		L		C	
			"	mm				"	mm	"	mm	"	mm
83105	3C2-4FJX45S	7303-01005	3/16	4.8	7/16-20	1/2	9/16	.33	8.4	2.80	71.1	1.71	43.4



### Female JIC 37° Flare Swivel - 90° Bent Tube

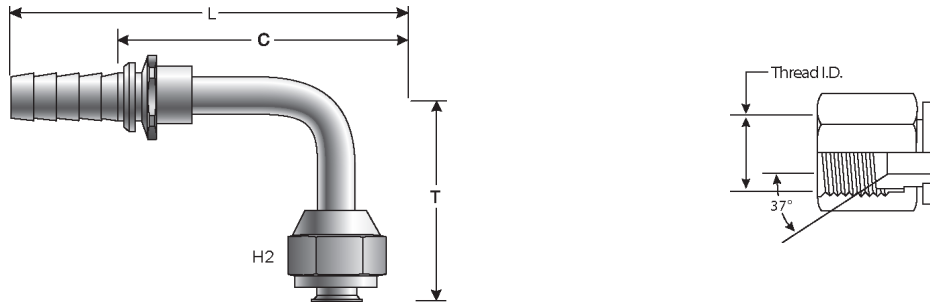

Part No.	Descr.	Prod. No.	⌀		H2	T	L		C			
			"	mm			"	mm	"	mm		
83125	3C2-4FJX90S	7303-01505	3/16	4.8	7/16-20	9/16	.68	17.3	2.54	64.5	1.45	36.8
83149	24C2-24FJX90S	7334-41255	1 1/2	38.1	1 7/8-12	2 1/4	4.00	101.6	7.11	180.6	4.47	113.5

### Female Flat-Face O-Ring Swivel

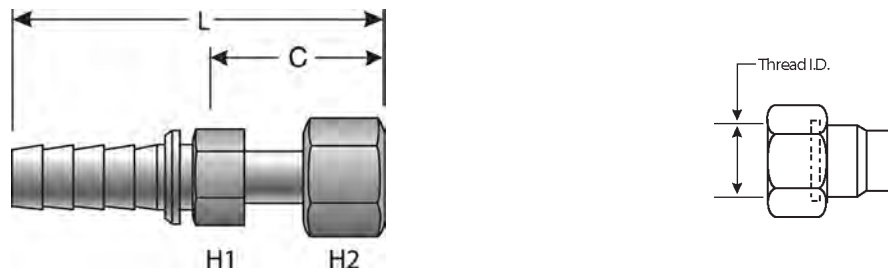

Part No.	Descr.	Prod. No.	⌀		H1	H2	L		C		
			"	mm			"	mm	"	mm	
83603	3C2-6FFORX	7303-05945	3/16	4.8	11/16-16	5/8	13/16	2.63	66.8	1.54	39.1

### SAE Male Inverted Swivel

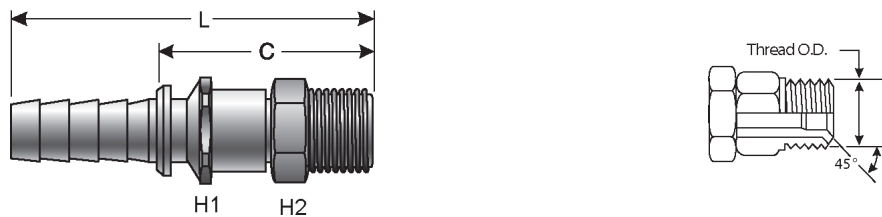

Part No.	Descr.	Prod. No.	⌀		H1	H2	L		C		
			"	mm			"	mm	"	mm	
83301	3C2-3MIX	7303-02995	3/16	4.8	3/8-24	1/2	3/8	2.67	67.8	1.58	40.1

- EQUIPMENT
- HOSE/CPLG. SELECTION
- G8K COUPLINGS
- GLOBALSPIRAL COUPLINGS
- STAINLESS STEEL SPIRAL
- MEGACRIMP COUPLINGS
- STAINLESS STEEL BRAID
- POWER CRIMP COUPLINGS**
- FIELD ATTACHABLE G1 & G2 COUPLINGS
- FIELD ATTACHABLE C5 COUPLINGS
- C14 COUPLINGS
- GL COUPLINGS
- GLX COUPLINGS
- PCTS THERMOPLASTIC COUPLINGS
- POLARSEAL COUPLINGS (ACA)
- POLARSEAL II COUPLINGS (ACC)
- POLARSEAL II COUPLINGS (ACB)
- POWER STEERING
- ADAPTERS
- QUICK DISCONNECT COUPLERS
- BALL VALVES
- LIVE SWIVEL
- ASSEMBLY FABRICATION
- ACCESSORIES
- EQUIPMENT AND PARTS
- KITS
- AIR BRAKE HOSE ASSY
- BRASS



EQUIPMENT
HOSE/CPLG. SELECTION
G8K COUPLINGS
GLOBAL SPIRAL COUPLINGS
STAINLESS STEEL SPIRAL
MEGACRIMP COUPLINGS
STAINLESS STEEL BRAID
<b>POWER CRIMP COUPLINGS</b>
FIELD ATTACHABLE G1 & G2 COUPLINGS
FIELD ATTACHABLE C5 COUPLINGS
C14 COUPLINGS
GL COUPLINGS
GLX COUPLINGS
PCTS THERMOPLASTIC COUPLINGS
POLARSEAL COUPLINGS (ACA)
POLARSEAL II COUPLINGS (ACC)
POLARSEAL II COUPLINGS (ACB)
POWER STEERING
ADAPTERS
QUICK DISCONNECT COUPLERS
BALL VALVES
LIVE SWIVEL
ASSEMBLY FABRICATION
ACCESSORIES
EQUIPMENT AND PARTS
KITS
AIR BRAKE HOSE ASSY
BRASS

### SAE Male Inverted Swivel - 45° Bent Tube

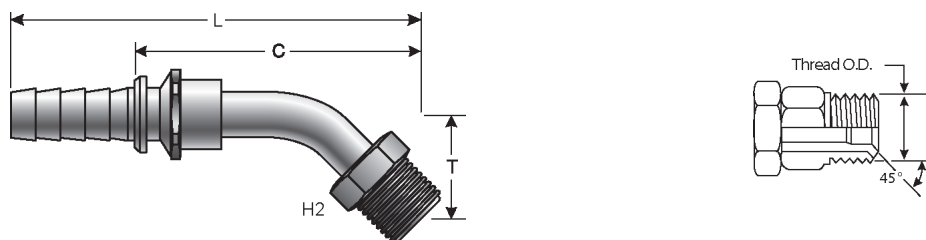

Part No.	Descr.	Prod. No.	⊖		H2	T	L		C			
			"	mm			"	mm	"	mm		
83302	3C2-3MIX45	7303-03205	3/16	4.8	3/8-24	3/8	.58	14.7	2.78	70.6	1.69	42.9

### SAE Male Inverted Swivel - 90° Bent Tube

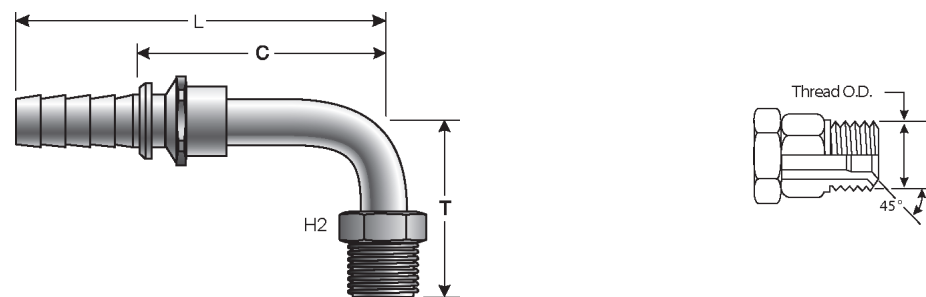

Part No.	Descr.	Prod. No.	⊖		H2	T	L		C			
			"	mm			"	mm	"	mm		
83303	3C2-3MIX90	7303-03495	3/16	4.8	3/8-24	3/8	1.05	26.7	2.42	61.5	1.33	33.8

### Female Braze-On Stems

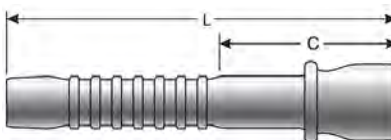

Part No.	Descr.	Prod. No.	⊖		L		C		⊖	
			"	mm	"	mm	"	mm	"	mm
80410	3-4FBO	7305-09135	3/16	4.8	1.76	44.7	.68	17.3	.56	14.2
80401	4-4FBO	7305-09145	1/4	6.4	1.67	42.4	.58	14.7	.56	14.2
80402	4-5FBO	7305-09165	1/4	6.4	1.67	42.4	.58	14.7	.56	14.2
80403	6-6FBO	7334-36755	3/8	9.5	1.72	43.7	.70	17.8	.75	19.1
80400	6-8FBO	7305-29165	3/8	9.5	1.72	43.7	.70	17.8	.88	22.4
80404	8-8FBO	7305-39145	1/2	12.7	2.20	55.9	.76	19.3	.88	22.4
80405	8-10FBO	7305-39165	1/2	12.7	2.20	55.9	.76	19.3	.88	22.4
80406	12-12FBO	7305-59145	3/4	19.1	2.47	62.7	.76	19.3	1.12	28.5
80407	12-16FBO	7305-59165	3/4	19.1	2.75	69.9	1.04	26.4	1.38	35.1



Female Braze-On Stems - Continued

Part No.	Descr.	Prod. No.	⊖		L		C		⊖	
			"	mm	"	mm	"	mm	"	mm
80408	16-16FBO	7305-69145	1	25.4	2.75	69.9	1.04	26.4	1.38	35.1
80409	20-20FBO	7305-79145	1 1/4	31.8	3.29	83.6	1.11	28.2	1.81	46.0
80411	24-24FBO	7305-89145	1 1/2	38.1	3.75	95.3	1.11	28.2	2.00	50.8

Female DIN 24° Cone Swivel - Light Series

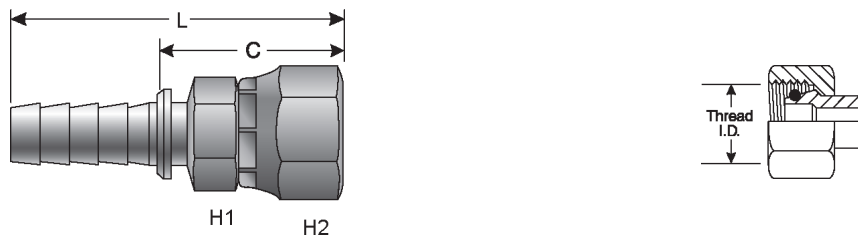

Part No.	Descr.	Prod. No.	⊖		M12X1.5	H1	H2	L		C		⊖
			"	mm				"	mm	"	mm	
83709	3C2-6FDLX	7303-08195	3/16	4.8	M12X1.5	14	14	2.20	55.9	1.11	28.2	6.0

Female DIN 24° Cone Swivel - Light Series - 90° Bent Tube

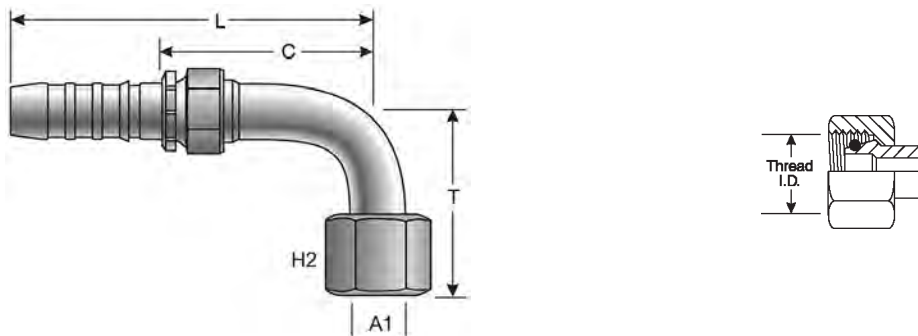

Part No.	Descr.	Prod. No.	⊖		M12X1.5	H2	T		L		C		A1
			"	mm			"	mm	"	mm	"	mm	
83740	3C2-6FDLX90	7303-08205	3/16	4.8	M12X1.5	14	1.26	32.0	2.52	64.0	1.43	36.3	6.0

- EQUIPMENT
- HOSE/CPLG. SELECTION
- G8K COUPLINGS
- GLOBALSPIRAL COUPLINGS
- STAINLESS STEEL SPIRAL
- MEGACRIMP COUPLINGS
- STAINLESS STEEL BRAID
- POWER CRIMP COUPLINGS
- FIELD ATTACHABLE G1 & G2 COUPLINGS
- FIELD ATTACHABLE C5 COUPLINGS
- C14 COUPLINGS
- GL COUPLINGS
- GLX COUPLINGS
- PCTS THERMOPLASTIC COUPLINGS
- POLARSEAL COUPLINGS (ACA)
- POLARSEAL II COUPLINGS (ACC)
- POLARSEAL II COUPLINGS (ACB)
- POWER STEERING
- ADAPTERS
- QUICK DISCONNECT COUPLERS
- BALL VALVES
- LIVE SWIVEL
- ASSEMBLY FABRICATION
- ACCESSORIES
- EQUIPMENT AND PARTS
- KITS
- AIR BRAKE HOSE ASSY
- BRASS



## Power Crimp® Two Ferrules (Steel) - PC2F Series

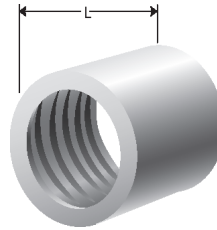

Part No.	Descr.	Prod. No.	L		Ø	
			"	mm	"	mm
80415	3PC2F-2	7266-00075	1.00	25.4	.76	19.3
80416	4PC2F-2	7266-00345	1.00	25.4	.84	21.3
80461	4PC2F-4	7266-00395	1.20	30.5	.89	22.6
80417	5PC2F-2	7266-00385	1.00	25.4	.87	22.1
80418	6PC2F-2	7266-00335	1.00	25.4	.94	23.9
80462	6PC2F-4	7266-00405	1.20	30.5	1.06	26.9
80419	8PC2F-2	7266-00025	1.25	31.8	1.13	28.7
80463	8PC2F-4	7266-00415	1.47	37.3	1.28	32.5
80476	10PC2F-2B	7266-00465	1.47	37.3	1.32	33.5
80447	10PC2F-2C	7266-08105	1.25	31.8	1.23	31.2
80423	12PC2F-2	7266-00185	1.47	37.3	1.50	38.1
80422	12PC2F-4	7266-00145	1.97	50.0	1.38	35.1
80424	16PC2F-2	7266-00135	1.97	50.0	1.75	44.5
80425	16PC2F-4	7266-00175	2.07	52.6	1.87	47.5
80427	20PC2F-2	7266-00225	2.35	59.7	2.25	57.2
80426	20PC2F-4	7266-00215	2.77	70.4	2.19	55.6
80428	24PC2F-4	7266-00355	2.88	73.2	2.55	64.8
80429	32PC2F-4	7266-00375	3.43	87.1	3.16	80.3

## Power Crimp® One Non-Skive Ferrules (Steel) - PC1FS Series

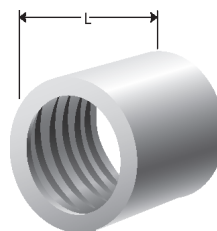

Part No.	Descr.	Prod. No.	L		Ø	
			"	mm	"	mm
80481	3PC1FS	7266-07035	1.20	30.5	.83	21.1
80584	4M3KPC	7266-07805	1.20	30.5	.89	22.6
80468	4PC1F-M2S	7266-07635	1.20	30.5	.83	21.1
80482	4PC1FS	7266-07045	1.28	32.5	.87	22.1
80483	5PC1FS	7266-07055	1.20	30.5	.97	24.6
80585	6M3KPC	7266-07815	1.20	30.5	.97	24.6
81512	6PC1F-M2S	7266-07375	1.20	30.5	1.06	26.9
80484	6PC1FS	7266-07065	1.20	30.5	.96	24.4
80586	8M3KPC	7266-07825	1.50	38.1	1.15	29.2
80474	8PC1F-M2S	7266-07395	1.47	37.3	1.20	30.5
80485	8PC1FS	7266-07085	1.47	37.3	1.15	29.2





## Power Crimp® One Non-Skive Ferrules (Steel) - PC1FS Series - Continued

Part No.	Descr.	Prod. No.	L		Ø	
			"	mm	"	mm
80477	10PC1F-M2S	7266-07415	1.47	37.3	1.31	33.3
80486	10PC1FS-M3K	7266-07105	1.49	37.9	1.21	30.7
80475	12PC1F-M2S	7266-07435	1.69	42.9	1.57	39.9
80487	12PC1FS-M3K	7266-07125	1.69	42.9	1.53	38.9
80480	16PC1F-M2S	7266-07475	1.69	42.9	1.94	49.3
80488	16PC1FS	7266-07165	1.69	42.9	1.32	33.5
80489	20PC1FS	7266-07205	2.41	61.2	2.38	60.5
80491	24PC1FS	7266-07245	2.69	68.3	2.69	68.3
80492	32PC1FS	7266-07325	3.56	90.4	3.25	82.6

EQUIPMENT
HOSE/CPLG. SELECTION
G8K COUPLINGS
GLOBALSPIRAL COUPLINGS
STAINLESS STEEL SPIRAL
MEGACRIMP COUPLINGS
STAINLESS STEEL BRAID
<b>POWER CRIMP COUPLINGS</b>
FIELD ATTACHABLE G1 & G2 COUPLINGS
FIELD ATTACHABLE C5 COUPLINGS
C14 COUPLINGS
GL COUPLINGS
GLX COUPLINGS
PCTS THERMOPLASTIC COUPLINGS
POLARSEAL COUPLINGS (ACA)
POLARSEAL II COUPLINGS (ACC)
POLARSEAL II COUPLINGS (ACB)
POWER STEERING
ADAPTERS
QUICK DISCONNECT COUPLERS
BALL VALVES
LIVE SWIVEL
ASSEMBLY FABRICATION
ACCESSORIES
EQUIPMENT AND PARTS
KITS
AIR BRAKE HOSE ASSY
BRASS



**NOTES**

EQUIPMENT
HOSE/CPLG. SELECTION
G8K COUPLINGS
GLOBAL SPIRAL COUPLINGS
STAINLESS STEEL SPIRAL
MEGACRIMP COUPLINGS
STAINLESS STEEL BRAID
<b>POWER CRIMP COUPLINGS</b>
FIELD ATTACHABLE G1 & G2 COUPLINGS
FIELD ATTACHABLE C5 COUPLINGS
C14 COUPLINGS
GL COUPLINGS
GLX COUPLINGS
PCTS THERMOPLASTIC COUPLINGS
POLARSEAL COUPLINGS (ACA)
POLARSEAL II COUPLINGS (ACC)
POLARSEAL II COUPLINGS (ACB)
POWER STEERING
ADAPTERS
QUICK DISCONNECT COUPLERS
BALL VALVES
LIVE SWIVEL
ASSEMBLY FABRICATION
ACCESSORIES
EQUIPMENT AND PARTS
KITS
AIR BRAKE HOSE ASSY
BRASS



# FIELD ATTACHABLE TYPE T FOR G1 HOSE (1 WIRE)

## Male Pipe (NPTF - 30° Cone Seat)



Part No.	Descr.	Prod. No.	⊖		H1	L		C		
			"	mm		"	mm	"	mm	
G27100-0402	4C1T-2RMP	7231-81241	1/4	6.4	1/8-27	1/2	2.30	58.4	1.29	32.8
G27100-0404	4C1T-4RMP	7231-81210	1/4	6.4	1/4-18	9/16	2.52	64.0	1.51	38.4
G27100-0604	6C1T-4RMP	7231-81242	3/8	9.5	1/4-18	9/16	2.68	68.1	1.54	39.1
G27100-0606	6C1T-6RMP	7231-81211	3/8	9.5	3/8-18	11/16	2.53	64.3	1.39	35.3
G27100-0806	8C1T-6RMP	7231-81243	1/2	12.7	3/8-18	11/16	3.05	77.5	1.70	43.2
G27100-0808	8C1T-8RMP	7231-81212	1/2	12.7	1/2-14	7/8	3.06	77.7	1.71	43.4
G27100-0812	8C1T-12RMP	7231-81244	1/2	12.7	3/4-14	1 1/16	3.13	79.5	1.87	47.5
G27100-1212	12C1T-12RMP	7231-81213	3/4	19.1	3/4-14	1 1/16	3.19	81.0	1.73	43.9
G27100-1616	16C1T-16RMP	7231-81214	1	25.4	1-11 1/2	1 3/8	3.78	96.0	2.10	53.3

## Male Pipe Swivel (NPTF - without 30° Cone Seat)

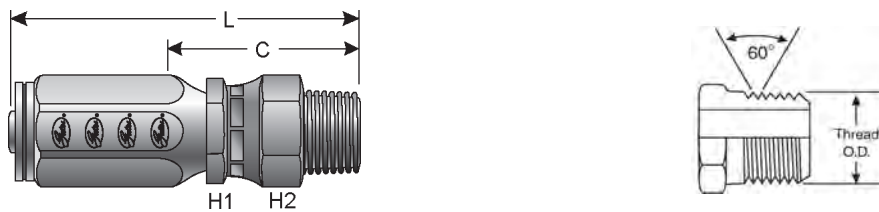

Part No.	Descr.	Prod. No.	⊖		H1	H2	L		C		
			"	mm			"	mm	"	mm	
G27105-0404	4C1T-4RMPX	7231-22445	1/4	6.4	1/4-18	7/16	7/8	3.18	80.8	2.17	55.1
G27105-0606	6C1T-6RMPX	7231-22455	3/8	9.5	3/8-18	5/8	7/8	3.51	89.2	2.23	56.6
G27105-0808	8C1T-8RMPX	7231-22465	1/2	12.7	1/2-14	3/4	1	3.99	101.4	2.63	66.8
G27105-1212	12C1T-12RMPX	7231-22475	3/4	19.1	3/4-14	1 1/16	1 5/16	4.27	108.5	2.73	69.3

- EQUIPMENT
- HOSE/CPLG. SELECTION
- G8K COUPLINGS
- GLOBALSPIRAL COUPLINGS
- STAINLESS STEEL SPIRAL
- MEGACRIMP COUPLINGS
- STAINLESS STEEL BRAID
- POWER CRIMP COUPLINGS
- FIELD ATTACHABLE G1 & G2 COUPLINGS**
- FIELD ATTACHABLE C5 COUPLINGS
- C14 COUPLINGS
- GL COUPLINGS
- GLX COUPLINGS
- PCTS THERMOPLASTIC COUPLINGS
- POLARSEAL COUPLINGS (ACA)
- POLARSEAL II COUPLINGS (ACC)
- POLARSEAL II COUPLINGS (ACB)
- POWER STEERING
- ADAPTERS
- QUICK DISCONNECT COUPLERS
- BALL VALVES
- LIVE SWIVEL
- ASSEMBLY FABRICATION
- ACCESSORIES
- EQUIPMENT AND PARTS
- KITS
- AIR BRAKE HOSE ASSY
- BRASS



EQUIPMENT
HOSE/CPLG. SELECTION
G8K COUPLINGS
GLOBAL SPIRAL COUPLINGS
STAINLESS STEEL SPIRAL
MEGACRIMP COUPLINGS
STAINLESS STEEL BRAID
POWER CRIMP COUPLINGS
FIELD ATTACHABLE G1 & G2 COUPLINGS
FIELD ATTACHABLE C5 COUPLINGS
C14 COUPLINGS
GL COUPLINGS
GLX COUPLINGS
PCTS THERMOPLASTIC COUPLINGS
POLARSEAL COUPLINGS (ACA)
POLARSEAL II COUPLINGS (ACC)
POLARSEAL II COUPLINGS (ACB)
POWER STEERING
ADAPTERS
QUICK DISCONNECT COUPLERS
BALL VALVES
LIVE SWIVEL
ASSEMBLY FABRICATION
ACCESSORIES
EQUIPMENT AND PARTS
KITS
AIR BRAKE HOSE ASSY
BRASS

### Male O-Ring Boss

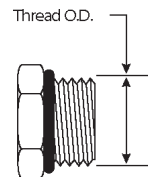
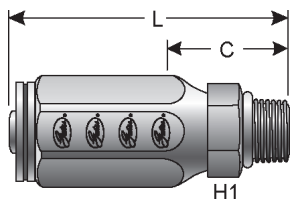

Part No.	Descr.	Prod. No.	⊖		H1	L		C		
			"	mm		"	"	"	mm	"
G27120-0606	6C1T-6RMB	7231-22255	3/8	9.5	9/16-18	11/16	2.52	64.0	1.24	31.5
G27120-0608	6C1T-8RMB	7231-22265	3/8	9.5	3/4-16	7/8	2.59	65.8	1.32	33.5
G27120-0808	8C1T-8RMB	7231-22275	1/2	12.7	3/4-16	7/8	2.87	72.9	1.52	38.6
G27120-0810	8C1T-10RMB	7231-22285	1/2	12.7	7/8-14	1	3.11	79.0	1.76	44.7

### Male JIC 37° Flare

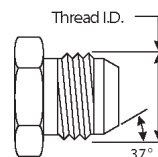
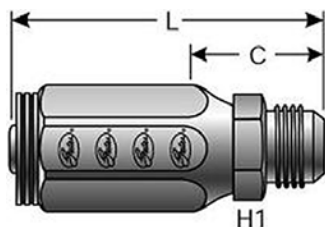

Part No.	Descr.	Prod. No.	⊖		H1	L		C		
			"	mm		"	"	"	mm	"
G27165-0606	6C1T-6RMJ	7231-22185	3/8	9.5	9/16-18	9/16	2.68	68.1	1.40	35.6
G27165-0808	8C1T-8RMJ	7231-22195	1/2	12.7	3/4-16	3/4	3.05	77.5	1.70	43.2
G27165-0810	8C1T-10RMJ	7231-22205	1/2	12.7	7/8-14	7/8	3.31	84.1	1.96	49.9
G27165-1212	12C1T-12RMJ	7231-22215	3/4	19.1	1 1/16-12	1 1/16	3.52	89.4	1.98	50.3

### Female JIC 37° Flare Swivel

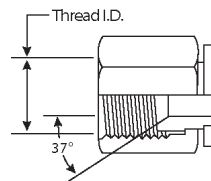
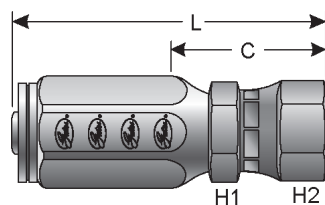

Part No.	Descr.	Prod. No.	⊖		H1	H2	L		C		
			"	mm			"	"	"	mm	"
G27170-0404	4C1T-4RFJX	7231-81215	1/4	6.4	7/16-20	9/16	9/16	2.47	62.7	1.46	37.1
G27170-0405	4C1T-5RFJX	7231-81216	1/4	6.4	1/2-20	11/16	11/16	2.58	65.5	1.57	39.9
G27170-0606	6C1T-6RFJX	7231-81217	3/8	9.5	9/16-18	3/4	3/4	2.80	71.1	1.65	41.9
G27170-0608	6C1T-8RFJX	7231-81218	3/8	9.5	3/4-16	3/4	7/8	2.91	73.9	1.76	44.7



Female JIC 37° Flare Swivel - Continued

Part No.	Descr.	Prod. No.	⊖		🌀	H1	H2	L		C	
			"	mm				"	mm	"	mm
G27170-0808	8C1T-8RFJX	7231-81219	1/2	12.7	3/4-16	13/16	7/8	3.24	82.3	1.89	48.1
G27170-0810	8C1T-10RFJX	7231-81220	1/2	12.7	7/8-14	13/16	1 1/16	3.34	84.8	1.99	50.6
G27170-1212	12C1T-12RFJX	7231-81221	3/4	19.1	1 1/16-12	1 1/8	1 1/4	3.45	87.6	1.91	48.5
G27170-1616	16C1T-16RFJX	7231-81222	1	25.4	1 5/16-12	1 3/8	1 1/2	3.90	99.1	2.22	56.4

Female JIC 37° Flare Swivel - 45° Bent Tube

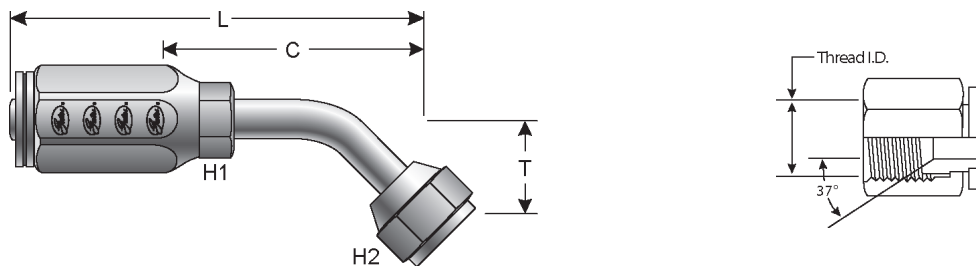

Part No.	Descr.	Prod. No.	⊖		🌀	H1	H2	T	L		C		
			"	mm					"	mm	"	mm	
G27175-0404	4C1T-4RFJX45	7231-22545	1/4	6.4	7/16-20	3/8	9/16	.33	8.4	2.80	71.1	1.79	45.5
G27175-0606	6C1T-6RFJX45	7231-22555	3/8	9.5	9/16-18	1/2	11/16	.39	10.0	3.37	85.6	1.79	45.5
G27175-0808	8C1T-8RFJX45	7231-22565	1/2	12.7	3/4-16	5/8	7/8	.55	14.0	4.11	104.4	2.10	53.3
G27175-1212	12C1T-12RFJX45	7231-22575	3/4	19.1	1 1/16-12	1 1/4	1 1/4	.78	19.8	4.70	119.4	3.16	80.3

Female JIC 37° Flare Swivel - 90° Bent Tube

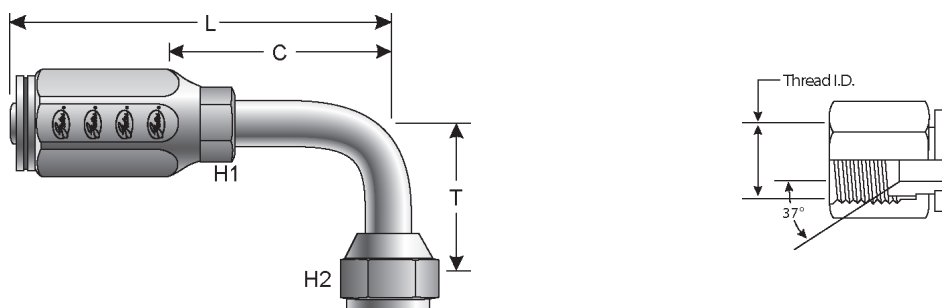

Part No.	Descr.	Prod. No.	⊖		🌀	H1	H2	T	L		C		
			"	mm					"	mm	"	mm	
G27180-0404	4C1T-4RFJX90	7231-22655	1/4	6.4	7/16-20	3/8	9/16	.68	17.3	2.69	68.3	1.68	42.7
G27180-0606	6C1T-6RFJX90	7231-22665	3/8	9.5	9/16-18	1/2	11/16	.85	21.6	3.28	83.3	2.00	50.8
G27180-0608	6C1T-8RFJX90	7231-22675	3/8	9.5	3/4-16	5/8	7/8	1.09	27.7	3.58	90.9	2.31	58.7
G27180-0808	8C1T-8RFJX90	7231-22685	1/2	12.7	3/4-16	5/8	7/8	1.09	27.7	3.86	98.1	2.51	63.8
G27180-0810	8C1T-10RFJX90	7231-22695	1/2	12.7	7/8-14	3/4	1	1.23	31.2	3.92	99.6	2.59	65.8
G27180-1212	12C1T-12RFJX90	7231-22705	3/4	19.1	1 1/16-12	1 1/4	1 1/4	1.82	46.2	4.59	116.6	3.05	77.5

EQUIPMENT
HOSE/CPLG. SELECTION
G8K COUPLINGS
GLOBAL SPIRAL COUPLINGS
STAINLESS STEEL SPIRAL
MEGACRIMP COUPLINGS
STAINLESS STEEL BRAID
POWER CRIMP COUPLINGS
FIELD ATTACHABLE G1 & G2 COUPLINGS
FIELD ATTACHABLE C5 COUPLINGS
C14 COUPLINGS
GL COUPLINGS
GLX COUPLINGS
PCTS THERMOPLASTIC COUPLINGS
POLARSEAL COUPLINGS (ACA)
POLARSEAL II COUPLINGS (ACC)
POLARSEAL II COUPLINGS (ACB)
POWER STEERING
ADAPTERS
QUICK DISCONNECT COUPLERS
BALL VALVES
LIVE SWIVEL
ASSEMBLY FABRICATION
ACCESSORIES
EQUIPMENT AND PARTS
KITS
AIR BRAKE HOSE ASSY
BRASS



EQUIPMENT
HOSE/CPLG. SELECTION
G8K COUPLINGS
GLOBAL SPIRAL COUPLINGS
STAINLESS STEEL SPIRAL
MEGACRIMP COUPLINGS
STAINLESS STEEL BRAID
POWER CRIMP COUPLINGS
FIELD ATTACHABLE G1 & G2 COUPLINGS
FIELD ATTACHABLE C5 COUPLINGS
C14 COUPLINGS
GL COUPLINGS
GLX COUPLINGS
PCTS THERMOPLASTIC COUPLINGS
POLARSEAL COUPLINGS (ACA)
POLARSEAL II COUPLINGS (ACC)
POLARSEAL II COUPLINGS (ACB)
POWER STEERING
ADAPTERS
QUICK DISCONNECT COUPLERS
BALL VALVES
LIVE SWIVEL
ASSEMBLY FABRICATION
ACCESSORIES
EQUIPMENT AND PARTS
KITS
AIR BRAKE HOSE ASSY
BRASS

### Male Pipe (NPTF - 30° Cone Seat)

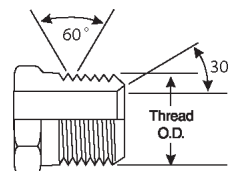
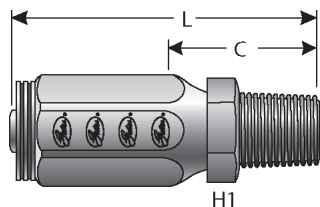

Part No.	Descr.	Prod. No.	⌀		H1	L		C		
			"	mm		"	mm	"	mm	
G28100-0402	4C2AT-2RMP	7231-81247	1/4	6.4	1/8-27	1/2	2.30	58.4	1.23	31.2
G28100-0404	4C2AT-4RMP	7231-81223	1/4	6.4	1/4-18	9/16	2.52	64.0	1.45	36.8
G28100-0604	6C2AT-4RMP	7231-81248	3/8	9.5	1/4-18	9/16	2.68	68.1	1.45	36.8
G28100-0606	6C2AT-6RMP	7231-81224	3/8	9.5	3/8-18	11/16	2.53	64.3	1.30	33.0
G28100-0806	8C2AT-6RMP	7231-81249	1/2	12.7	3/8-18	11/16	3.05	77.5	1.63	41.4
G28100-0808	8C2AT-8RMP	7231-81225	1/2	12.7	1/2-14	7/8	3.06	77.7	1.64	41.7
G28100-0812	8C2AT-12RMP	7231-81251	1/2	12.7	3/4-14	1 1/16	3.13	79.5	1.71	43.4
G28100-1212	12C2AT-12RMP	7231-81226	3/4	19.1	3/4-14	1 1/16	3.19	81.0	1.65	41.9
G28100-1616	16C2AT-16RMP	7231-81227	1	25.4	1-11 1/2	1 3/8	3.78	96.0	2.04	51.8
G28100-2020	20C2AT-20RMP	7231-81228	1 1/4	31.8	1 1/4-11 1/2	1 3/4	4.59	116.6	2.49	63.3
G28100-2424	24C2AT-24RMP	7231-81252	1 1/2	38.1	1 1/2-11 1/2	2	5.18	131.6	2.68	68.1

### Male Pipe Swivel (NPTF - without 30° Cone Seat)

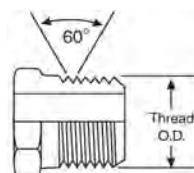
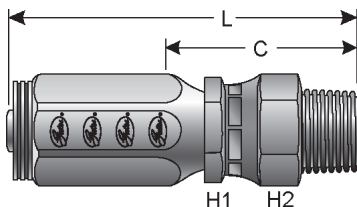

Part No.	Descr.	Prod. No.	⌀		H1	H2	L		C		
			"	mm			"	mm	"	mm	
G28105-0404	4C2AT-4RMPX	7231-22495	1/4	6.4	1/4-18	7/16	11/16	3.18	80.8	2.11	53.6
G28105-0606	6C2AT-6RMPX	7231-22505	3/8	9.5	3/8-18	5/8	7/8	3.51	89.2	2.27	57.7
G28105-0808	8C2AT-8RMPX	7231-22515	1/2	12.7	1/2-14	3/4	1	3.99	101.4	2.56	65.0
G28105-1212	12C2AT-12RMPX	7231-22525	3/4	19.1	3/4-14	1 1/16	1 5/16	4.27	108.5	2.73	69.3



### Male O-Ring Boss

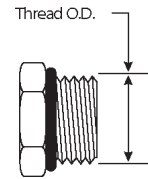
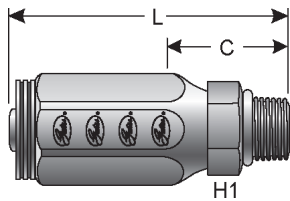

Part No.	Descr.	Prod. No.	⌀		H1	L		C		
			"	mm		"	"	"	mm	"
G28120-0606	6C2AT-6RMB	7231-22355	3/8	9.5	9/16-18	11/16	2.52	64.0	1.28	32.5
G28120-0608	6C2AT-8RMB	7231-22365	3/8	9.5	3/4-16	7/8	2.59	65.8	1.36	34.5
G28120-0808	8C2AT-8RMB	7231-22375	1/2	12.7	3/4-16	7/8	2.87	72.9	1.45	36.8
G28120-0810	8C2AT-10RMB	7231-22385	1/2	12.7	7/8-14	1	3.11	79.0	1.59	40.4

### Male JIC 37° Flare

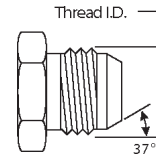
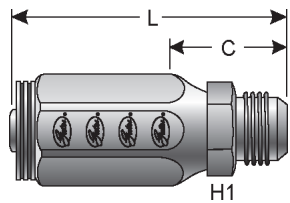

Part No.	Descr.	Prod. No.	⌀		H1	L		C		
			"	mm		"	"	"	mm	"
G28165-0606	6C2AT-6RMJ	7231-22025	3/8	9.5	9/16-18	9/16	2.68	68.1	1.45	36.8
G28165-0808	8C2AT-8RMJ	7231-22045	1/2	12.7	3/4-16	3/4	3.05	77.5	1.63	41.4
G28165-0810	8C2AT-10RMJ	7231-22055	1/2	12.7	7/8-14	7/8	3.31	84.1	1.89	48.1
G28165-1212	12C2AT-12RMJ	7231-22065	3/4	19.1	1 1/16-12	1 1/16	3.52	89.4	1.98	50.3

### Female JIC 37° Flare Swivel

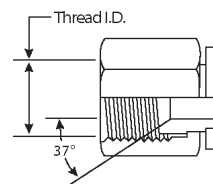
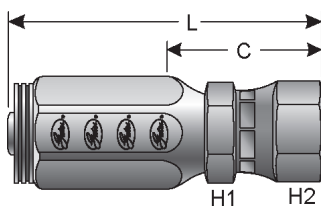

Part No.	Descr.	Prod. No.	⌀		H1	H2	L		C		
			"	mm			"	"	"	mm	"
G28170-0404	4C2AT-4RFJX	7231-81229	1/4	6.4	7/16-20	9/16	9/16	2.47	62.7	1.40	35.6
G28170-0405	4C2AT-5RFJX	7231-81230	1/4	6.4	1/2-20	11/16	11/16	2.58	65.5	1.57	39.9
G28170-0606	6C2AT-6RFJX	7231-81231	3/8	9.5	9/16-18	3/4	3/4	2.80	71.1	1.56	39.6
G28170-0608	6C2AT-8RFJX	7231-81232	3/8	9.5	3/4-16	3/4	3/4	2.91	73.9	1.67	42.4
G28170-0808	8C2AT-8RFJX	7231-81233	1/2	12.7	3/4-16	13/16	7/8	3.24	82.3	1.82	46.2
G28170-0810	8C2AT-10RFJX	7231-81234	1/2	12.7	7/8-14	1 1/16	1 1/16	3.34	84.8	1.92	48.8

EQUIPMENT
HOSE/CPLG. SELECTION
G8K COUPLINGS
GLOBALSPIRAL COUPLINGS
STAINLESS STEEL SPIRAL
MEGACRIMP COUPLINGS
STAINLESS STEEL BRAID
POWER CRIMP COUPLINGS
FIELD ATTACHABLE G1 & G2 COUPLINGS
FIELD ATTACHABLE C5 COUPLINGS
C14 COUPLINGS
GL COUPLINGS
GLX COUPLINGS
PCTS THERMOPLASTIC COUPLINGS
POLARSEAL COUPLINGS (ACA)
POLARSEAL II COUPLINGS (ACC)
POLARSEAL II COUPLINGS (ACB)
POWER STEERING
ADAPTERS
QUICK DISCONNECT COUPLERS
BALL VALVES
LIVE SWIVEL
ASSEMBLY FABRICATION
ACCESSORIES
EQUIPMENT AND PARTS
KITS
AIR BRAKE HOSE ASSY
BRASS





EQUIPMENT
HOSE/CPLG. SELECTION
G8K COUPLINGS
GLOBAL SPIRAL COUPLINGS
STAINLESS STEEL SPIRAL
MEGACRIMP COUPLINGS
STAINLESS STEEL BRAID
POWER CRIMP COUPLINGS
FIELD ATTACHABLE G1 & G2 COUPLINGS
FIELD ATTACHABLE C5 COUPLINGS
C14 COUPLINGS
GL COUPLINGS
GLX COUPLINGS
PCTS THERMOPLASTIC COUPLINGS
POLARSEAL COUPLINGS (ACA)
POLARSEAL II COUPLINGS (ACC)
POLARSEAL II COUPLINGS (ACB)
POWER STEERING
ADAPTERS
QUICK DISCONNECT COUPLERS
BALL VALVES
LIVE SWIVEL
ASSEMBLY FABRICATION
ACCESSORIES
EQUIPMENT AND PARTS
KITS
AIR BRAKE HOSE ASSY
BRASS

### Female JIC 37° Flare Swivel - Continued

Part No.	Descr.	Prod. No.	⊖		H1	H2	L		C		
			"	mm			"	mm	"	mm	
G28170-1212	12C2AT-12RFJX	7231-81235	3/4	19.1	1 1/16-12	1 1/8	1 1/2	3.45	87.6	1.91	48.5
G28170-1616	16C2AT-16RFJX	7231-81236	1	25.4	1 5/16-12	1 3/8	1 1/2	3.90	99.1	2.16	54.9
G28170-2020	20C2AT-20RFJX	7231-81237	1 1/4	31.8	1 5/8-12	1 7/8	2	4.85	123.2	2.74	69.6
G28170-2424	24C2AT-24RFJX	7231-81254	1 1/2	38.1	1 7/8-12	2 1/8	2 1/4	5.26	133.6	2.76	70.1

### Female JIC 37° Flare Swivel - 45° Bent Tube

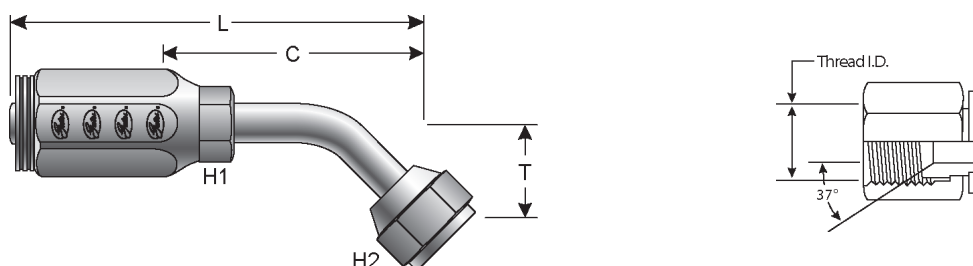

Part No.	Descr.	Prod. No.	⊖		H1	H2	T		L		C		
			"	mm			"	mm	"	mm	"	mm	
G28175-0404	4C2AT-4RFJX45	7231-22595	1/4	6.4	7/16-20	3/8	9/16	.33	8.4	2.80	71.1	1.73	43.9
G28175-0606	6C2AT-6RFJX45	7231-22605	3/8	9.5	9/16-18	1/2	11/16	.39	10.0	3.37	85.6	2.14	54.4
G28175-0808	8C2AT-8RFJX45	7231-22615	1/2	12.7	3/4-16	5/8	7/8	.55	14.0	4.11	104.4	2.68	68.1
G28175-1212	12C2AT-12RFJX45	7231-22625	3/4	19.1	1 1/16-12	7/8	1 1/4	.78	19.8	4.70	119.4	3.16	80.3

### Female JIC 37° Flare Swivel - 90° Bent Tube

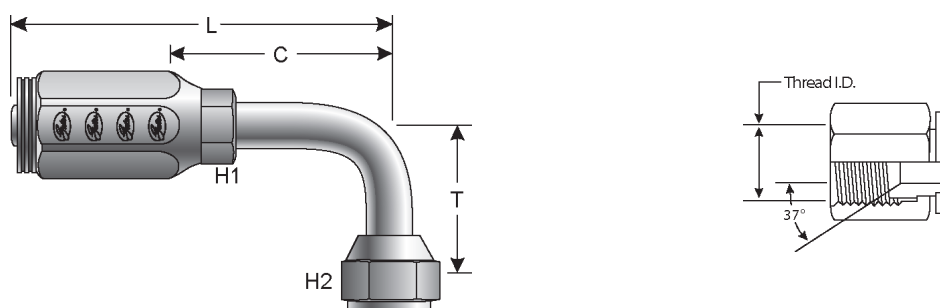

Part No.	Descr.	Prod. No.	⊖		H1	H2	T		L		C		
			"	mm			"	mm	"	mm	"	mm	
G28180-0404	4C2AT-4RFJX90	7231-22755	1/4	6.4	7/16-20	3/8	9/16	.68	17.3	2.69	68.3	1.62	41.2
G28180-0606	6C2AT-6RFJX90	7231-22765	3/8	9.5	9/16-18	1/2	11/16	.85	21.6	3.28	83.3	2.04	51.8
G28180-0608	6C2AT-8RFJX90	7231-22775	3/8	9.5	3/4-16	5/8	7/8	1.09	27.7	3.58	90.9	2.35	59.7
G28180-0808	8C2AT-8RFJX90	7231-22785	1/2	12.7	3/4-16	5/8	7/8	1.09	27.7	3.86	98.1	2.42	61.5
G28180-0810	8C2AT-10RFJX90	7231-22795	1/2	12.7	7/8-14	3/4	1	1.23	31.2	3.92	99.6	2.50	63.5
G28180-1212	12C2AT-12RFJX90	7231-22805	3/4	19.1	1 1/16-12	7/8	1 1/4	1.82	46.2	4.59	116.6	3.05	77.5



## Female Flat-Face O-Ring Swivel

SAE J1453 O-Ring Face Seal.

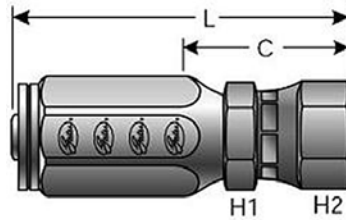

Part No.	Descr.	Prod. No.	⌀		🌀	H1	H2	L		C	
			"	mm				"	mm	"	mm
G28230-0404	4C2AT-4RFFORX	7231-14105	1/4	6.4	9/16-18	43/64	43/64	2.50	63.5	1.43	36.3
G28230-0606	6C2AT-6RFFORX	7231-14125	3/8	9.5	11/16-16	7/8	7/8	2.88	73.2	1.64	41.7
G28230-0808	8C2AT-8RFFORX	7231-14145	1/2	12.7	13/16-16	61/64	61/64	3.37	85.6	1.94	49.3
G28230-1212	12C2AT-12RFFORX	7231-14165	3/4	19.1	1 3/16-12	1 1/8	1 13/32	2.03	51.6	3.57	90.7

## Female Flat-Face O-Ring Swivel - 45° Bent Tube

SAE J1453 O-Ring Face Seal.

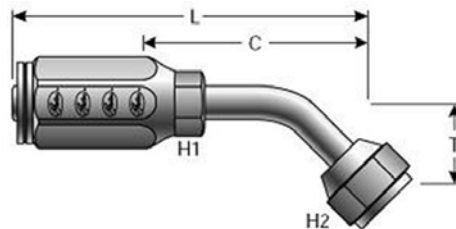

Part No.	Descr.	Prod. No.	⌀		🌀	H1	H2	T	L		C		
			"	mm					"	mm	"	mm	
G28234-0404	4C2AT-4RFFORX45S	7231-14305	1/4	6.4	9/16-18	3/8	9/16	.68	17.3	2.69	68.3	1.62	41.2
G28234-0606	6C2AT-6RFFORX45S	7231-14325	3/8	9.5	11/16-16	1/2	11/16	.85	21.6	3.28	83.3	2.04	51.8
G28234-0808	8C2AT-8RFFORX45S	7231-14345	1/2	12.7	13/16-16	5/8	7/8	1.09	27.7	3.86	98.1	2.42	61.5
G28234-1212	12C2AT-12RFFORX45S	7231-14365	3/4	19.1	1 3/16-12	7/8	1 1/4	1.82	46.2	4.59	116.6	3.05	77.5

EQUIPMENT
HOSE/CPLG. SELECTION
G8K COUPLINGS
GLOBALSPIRAL COUPLINGS
STAINLESS STEEL SPIRAL
MEGACRIMP COUPLINGS
STAINLESS STEEL BRAID
POWER CRIMP COUPLINGS
<b>FIELD ATTACHABLE G1 &amp; G2 COUPLINGS</b>
FIELD ATTACHABLE C5 COUPLINGS
C14 COUPLINGS
GL COUPLINGS
GLX COUPLINGS
PCTS THERMOPLASTIC COUPLINGS
POLARSEAL COUPLINGS (ACA)
POLARSEAL II COUPLINGS (ACC)
POLARSEAL II COUPLINGS (ACB)
POWER STEERING
ADAPTERS
QUICK DISCONNECT COUPLERS
BALL VALVES
LIVE SWIVEL
ASSEMBLY FABRICATION
ACCESSORIES
EQUIPMENT AND PARTS
KITS
AIR BRAKE HOSE ASSY
BRASS



## Female Flat-Face O-Ring Swivel - 90° Bent Tube

SAE J1453 O-Ring Face Seal.

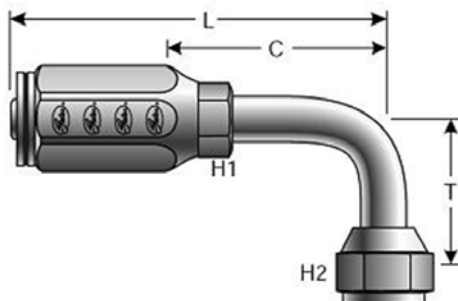

Part No.	Descr.	Prod. No.	⊖		🌀		H1	H2	T		L		C	
			"	mm	"	"	"	"	"	mm	"	mm	"	mm
G28239-0404	4C2AT-4RFFORX90S	7231-14505	1/4	6.4	9/16-18	3/8	9/16	.68	17.3	2.69	68.3	1.62	41.2	
G28239-0606	6C2AT-6RFFORX90S	7231-14525	3/8	9.5	11/16-16	1/2	11/16	.85	21.6	3.28	83.3	2.04	51.8	
G28239-0808	8C2AT-8RFFORX90S	7231-14545	1/2	12.7	13/16-16	5/8	7/8	1.09	27.7	3.86	98.1	2.42	61.5	
G28239-1212	12C2AT-12RFFORX90S	7231-14565	3/4	19.1	1 3/16-12	—	7/8	1.88	40.8	4.54	115.3	3.00	76.2	

EQUIPMENT
HOSE/CPLG. SELECTION
G8K COUPLINGS
GLOBAL SPIRAL COUPLINGS
STAINLESS STEEL SPIRAL
MEGACRIMP COUPLINGS
STAINLESS STEEL BRAID
POWER CRIMP COUPLINGS
<b>FIELD ATTACHABLE G1 &amp; G2 COUPLINGS</b>
FIELD ATTACHABLE C5 COUPLINGS
C14 COUPLINGS
GL COUPLINGS
GLX COUPLINGS
PCTS THERMOPLASTIC COUPLINGS
POLARSEAL COUPLINGS (ACA)
POLARSEAL II COUPLINGS (ACC)
POLARSEAL II COUPLINGS (ACB)
POWER STEERING
ADAPTERS
QUICK DISCONNECT COUPLERS
BALL VALVES
LIVE SWIVEL
ASSEMBLY FABRICATION
ACCESSORIES
EQUIPMENT AND PARTS
KITS
AIR BRAKE HOSE ASSY
BRASS



## HYDRAULIC HOSE FOR C5C, C5CXH, C5D & C5M COUPLINGS

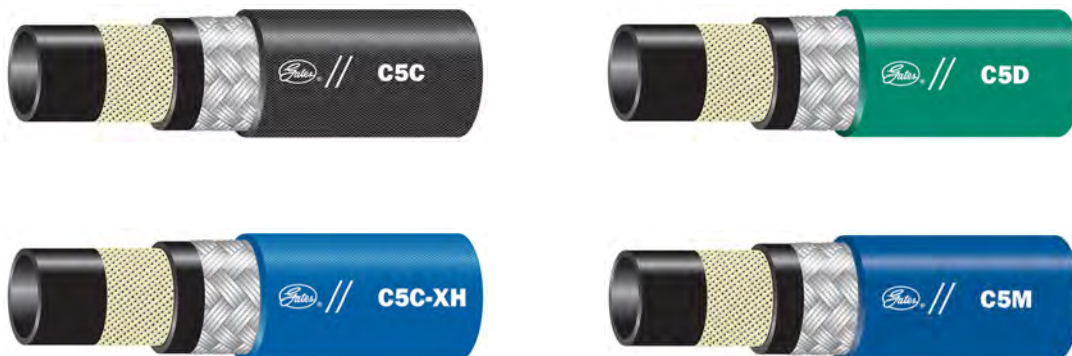

## HYDRAULIC HOSE FOR C5E COUPLINGS



**The Gates eCrimp program** is a web based utility which allows users and distributors of Gates hydraulic and industrial hose products to find and print the most up to date crimp specifications with nothing more than an internet browser.

This program can be used to find crimp data for all Gates crimpers. Custom result may be printed by selecting the crimper, hose and coupling. Optionally results may also be limited by die set and working pressure.

The eCrimp web application can be directly accessed from a web browser by entering <http://eCrimp.Gates.com> for the website.

**The eCrimp mobile app** is available for download for the iPhone and iPad from the App Store.

EQUIPMENT
HOSE/CPLG. SELECTION
G8K COUPLINGS
GLOBALSPIRAL COUPLINGS
STAINLESS STEEL SPIRAL
MEGACRIMP COUPLINGS
STAINLESS STEEL BRAID
POWER CRIMP COUPLINGS
FIELD ATTACHABLE G1 & G2 COUPLINGS
FIELD ATTACHABLE C5 COUPLINGS
C14 COUPLINGS
GL COUPLINGS
GLX COUPLINGS
PCTS THERMOPLASTIC COUPLINGS
POLARSEAL COUPLINGS (ACA)
POLARSEAL II COUPLINGS (ACC)
POLARSEAL II COUPLINGS (ACB)
POWER STEERING
ADAPTERS
QUICK DISCONNECT COUPLERS
BALL VALVES
LIVE SWIVEL
ASSEMBLY FABRICATION
ACCESSORIES
EQUIPMENT AND PARTS
KITS
AIR BRAKE HOSE ASSY
BRASS



EQUIPMENT
HOSE/CPLG. SELECTION
G8K COUPLINGS
GLOBAL SPIRAL COUPLINGS
STAINLESS STEEL SPIRAL
MEGACRIMP COUPLINGS
STAINLESS STEEL BRAID
POWER CRIMP COUPLINGS
FIELD ATTACHABLE G1 & G2 COUPLINGS
FIELD ATTACHABLE C5 COUPLINGS
C14 COUPLINGS
GL COUPLINGS
GLX COUPLINGS
PCTS THERMOPLASTIC COUPLINGS
POLARSEAL COUPLINGS (ACA)
POLARSEAL II COUPLINGS (ACC)
POLARSEAL II COUPLINGS (ACB)
POWER STEERING
ADAPTERS
QUICK DISCONNECT COUPLERS
BALL VALVES
LIVE SWIVEL
ASSEMBLY FABRICATION
ACCESSORIES
EQUIPMENT AND PARTS
KITS
AIR BRAKE HOSE ASSY
BRASS

### Male Pipe (NPTF - 30° Cone Seat) - Steel

DOT FMVSS 106-74 Type All.

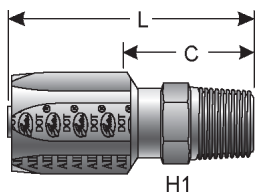

H1

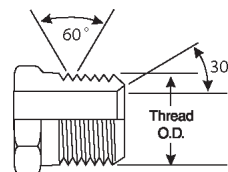

Part No.	Descr.	Prod. No.	⊖		H1	L		C		
			"	mm		"	mm	"	mm	
G34100-0402	4C5-2RMP	7236-04015	3/16	4.8	1/8-27	1/2	1.64	41.7	.94	23.9
G34100-0404	4C5-4RMP	7236-04025	3/16	4.8	1/4-18	9/16	1.83	46.5	1.13	28.7
G34100-0502	5C5X-2RMP	7237-00145	1/4	6.4	1/8-27	1/2	1.77	45.0	1.00	25.4
G34100-0504	5C5X-4RMP	7237-00155	1/4	6.4	1/4-18	9/16	1.96	49.8	1.19	30.2
G34100-0604	6C5-4RMP	7236-04055	5/16	7.9	1/4-18	9/16	2.17	55.1	1.22	31.0
G34100-0606	6C5-6RMP	7236-04275	5/16	7.9	3/8-18	11/16	2.17	55.1	1.22	31.0
G34100-0806	8C5X-6RMP	7237-00195	13/32	10.3	3/8-18	11/16	2.46	62.5	1.34	34.0
G34100-0808	8C5X-8RMP	7237-00205	13/32	10.3	1/2-14	7/8	2.71	68.8	1.59	40.4
G34100-1008	10C5-8RMP	7236-04085	1/2	12.7	1/2-14	1 1/16	2.88	73.2	1.59	40.4
G34100-1012	10C5-12RMP	7236-04095	1/2	12.7	3/4-14	1	2.95	74.9	1.66	42.2
G34100-1208	12C5X-8RMP	7237-00235	5/8	15.9	1/2-14	7/8	3.15	80.0	1.59	40.4
G34100-1212	12C5X-12RMP	7237-00245	5/8	15.9	3/4-14	1 1/16	3.25	82.6	1.69	42.9
G34100-1612	16C5-12RMP	7236-86412	7/8	22.2	3/4-14	1 1/8	2.71	68.8	1.53	38.9
G34100-1616	16C5-16RMP	7236-86413	7/8	22.2	1-11 1/2	1 3/8	2.90	73.7	1.72	43.7
G34100-2020	20C5-20RMP	7236-86428	1 1/8	28.6	1 1/4-11 1/2	1 11/16	3.25	82.6	1.88	47.8
G34100-2424	24C5-24RMP	7236-86388	1 3/8	34.9	1 1/2-11 1/2	2	3.45	87.6	2.03	51.6
G34100-3232	32C5-32RMP	7236-86389	1 13/16	46.0	2-11 1/2	2 1/2	4.07	103.4	2.22	56.4

### Male Pipe (NPTF - 30° Cone Seat) - Brass

DOT FMVSS 106-74 Type All.

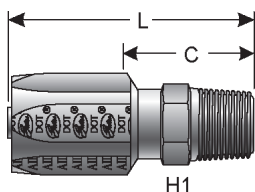

H1

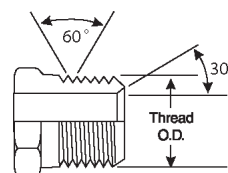

Part No.	Descr.	Prod. No.	⊖		H1	L		C		
			"	mm		"	mm	"	mm	
△ G34100-0606B	6C5-6RMPB	7236-03015	5/16	7.9	3/8-18	11/16	2.17	55.1	1.22	31.0
△ G34100-0808B	8C5-8RMPB	7236-03085	13/32	10.3	1/2-14	7/8	2.71	68.8	1.59	40.4
△ G34100-1008B	10C5-8RMPB	7236-03035	1/2	12.7	1/2-14	7/8	2.88	73.2	1.59	40.4
△ G34100-1616B	16C5-16RMPB	7236-03065	7/8	22.2	1-11 1/2	1 3/8	2.91	73.9	1.72	43.7

⚠ WARNING: Cancer and Reproductive Harm - www.P65Warnings.ca.gov



FIELD ATTACHABLE FOR C5CXH, C5C, C5D & C5M HOSE

## Male O-Ring Boss - Steel

DOT FMVSS 106-74 Type AII.

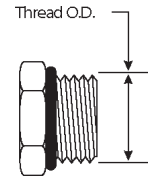
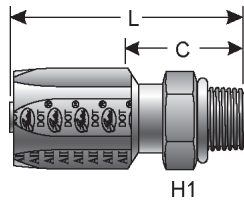

Part No.	Descr.	Prod. No.	⊖		H1	L		C		
			"	mm		"	"	mm	"	mm
G34120-0404	4C5-4RMB	7236-86451	3/16	4.8	7/16-20	5/8	1.66	42.2	.94	23.9
G34120-0606	6C5-6RMB	7236-86453	5/16	7.9	9/16-18	11/16	2.00	50.8	1.05	26.7
G34120-0808	8C5X-8RMB	7237-00635	13/32	10.3	3/4-16	15/16	2.35	59.7	1.19	30.2

## Male JIC 37° Flare - Steel

DOT FMVSS 106-74 Type AII.

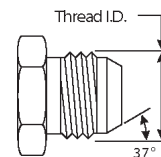
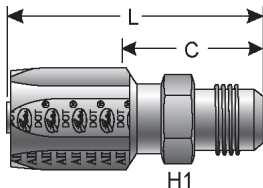

Part No.	Descr.	Prod. No.	⊖		H1	L		C		
			"	mm		"	"	mm	"	mm
G34165-0404	4C5-4RMJ	7236-86431	3/16	4.8	7/16-20	1/2	1.79	45.5	1.09	27.7
G34165-0505	5C5X-5RMJ	7237-00655	1/4	6.4	1/2-20	1/2	1.96	49.8	1.19	30.2
G34165-0606	6C5-6RMJ	7236-86433	5/16	7.9	9/16-18	9/16	2.17	55.1	1.22	31.0
G34165-0808	8C5X-8RMJ	7237-00675	13/32	10.3	3/4-16	3/4	2.56	65.0	1.44	36.6
G34165-1010	10C5-10RMJ	7236-86435	1/2	12.7	7/8-14	7/8	2.88	73.2	1.59	40.4
G34165-1212	12C5X-12RMJ	7237-00695	5/8	15.9	1 1/16-12	1 1/16	3.34	84.8	1.78	45.2
G34165-1616	16C5-16RMJ	7236-86437	7/8	22.2	1 5/16-12	1 5/16	2.87	72.9	1.69	42.9

## Female JIC 37° Flare Swivel - Steel

DOT FMVSS 106-74 Type AII.

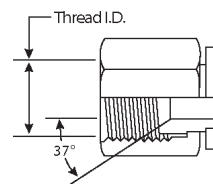
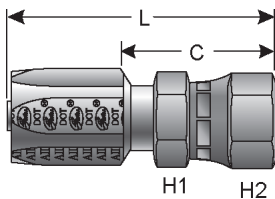

Part No.	Descr.	Prod. No.	⊖		H1	H2	L		C		
			"	mm			"	"	mm	"	mm
G34170-0606	6C5-6RFJX	7238-86443	5/16	7.9	9/16-18	3/4	3/4	2.39	60.7	1.44	36.6
G34170-0806	8C5X-6RFJX	7237-00415	13/32	10.3	9/16-18	3/4	3/4	2.66	67.6	1.54	39.1

EQUIPMENT
HOSE/CPLG. SELECTION
G8K COUPLINGS
GLOBALSPIRAL COUPLINGS
STAINLESS STEEL SPIRAL
MEGACRIMP COUPLINGS
STAINLESS STEEL BRAID
POWER CRIMP COUPLINGS
FIELD ATTACHABLE G1 & G2 COUPLINGS
FIELD ATTACHABLE C5 COUPLINGS
C14 COUPLINGS
GL COUPLINGS
GLX COUPLINGS
PCTS THERMOPLASTIC COUPLINGS
POLARSEAL COUPLINGS (ACA)
POLARSEAL II COUPLINGS (ACC)
POLARSEAL II COUPLINGS (ACB)
POWER STEERING
ADAPTERS
QUICK DISCONNECT COUPLERS
BALL VALVES
LIVE SWIVEL
ASSEMBLY FABRICATION
ACCESSORIES
EQUIPMENT AND PARTS
KITS
AIR BRAKE HOSE ASSY
BRASS



EQUIPMENT
HOSE/CPLG. SELECTION
G8K COUPLINGS
GLOBAL SPIRAL COUPLINGS
STAINLESS STEEL SPIRAL
MEGACRIMP COUPLINGS
STAINLESS STEEL BRAID
POWER CRIMP COUPLINGS
FIELD ATTACHABLE G1 & G2 COUPLINGS
FIELD ATTACHABLE C5 COUPLINGS
C14 COUPLINGS
GL COUPLINGS
GLX COUPLINGS
PCTS THERMOPLASTIC COUPLINGS
POLARSEAL COUPLINGS (ACA)
POLARSEAL II COUPLINGS (ACC)
POLARSEAL II COUPLINGS (ACB)
POWER STEERING
ADAPTERS
QUICK DISCONNECT COUPLERS
BALL VALVES
LIVE SWIVEL
ASSEMBLY FABRICATION
ACCESSORIES
EQUIPMENT AND PARTS
KITS
AIR BRAKE HOSE ASSY
BRASS

### Female JIC 37° Flare Swivel - Steel - Continued

Part No.	Descr.	Prod. No.	⊖		H1	H2	L		C		
			"	mm			"	mm	"	mm	
G34170-1012	10C5-12RFJX	7238-04325	1/2	12.7	1 1/16-12	1 1/4	1 1/4	3.22	81.8	1.93	49.0
G34170-1212	12C5X-12RFJX	7237-00455	5/8	15.9	1 1/16-12	1 1/4	1 1/4	3.50	88.9	1.94	49.3
G34170-1616	16C5-16RFJX	7238-86447	7/8	22.2	1 5/16-12	1 1/2	1 1/2	3.12	79.3	1.94	49.3
G34170-2020	20C5-20RFJX	7238-86394	1 1/8	28.6	1 5/8-12	2	2	3.56	90.4	2.19	55.6
G34170-2424	24C5-24RFJX	7238-86395	1 3/8	34.9	1 7/8-12	2 1/4	2 1/4	3.79	96.3	2.37	60.2
G34170-3232	32C5-32RFJX	7238-86396	1 13/16	46.0	2 1/2-12	2 1/2	2 7/8	4.99	126.8	2.72	69.1

### Female JIC 37° Flare Swivel - Brass

DOT FMVSS 106-74 Type All.

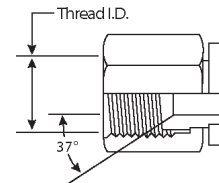
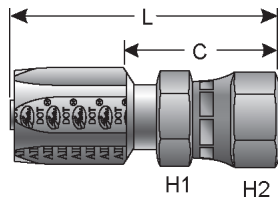

Part No.	Descr.	Prod. No.	⊖		H1	H2	L		C		
			"	mm			"	mm	"	mm	
△ G34170-0606B	6C5-6RFJXB	7238-04075	5/16	7.9	9/16-18	3/4	3/4	2.39	60.7	1.44	36.6
△ G34170-1212B	12C5-12RFJXB	7238-04085	5/8	15.9	1 1/16-12	1 1/4	1 1/4	3.50	88.9	1.94	49.3
△ G34170-1616B	16C5-16RFJXB	7238-04095	7/8	22.2	1 5/16-12	1 1/2	1 1/2	3.12	79.3	1.94	49.3

⚠ WARNING: Cancer and Reproductive Harm - www.P65Warnings.ca.gov

### Female JIC 37° Flare Swivel - 45° Bent Tube - Steel

DOT FMVSS 106-74 Type All.

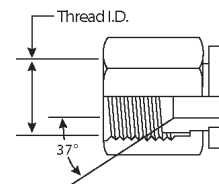
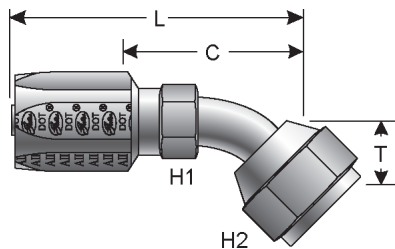

Part No.	Descr.	Prod. No.	⊖		H1	H2	T		L		C		
			"	mm			"	mm	"	mm	"	mm	
G34175-0606	6C5-6RFJX45	7235-86464	5/16	7.9	9/16-18	1/2	11/16	.41	10.4	2.40	61.0	1.45	36.8
G34175-1212	12C5X-12RFJX45S	7237-00535	5/8	15.9	1 1/16-12	7/8	1 1/4	.78	19.8	4.27	108.5	2.71	68.8
G34175-1616	16C5-16RFJX45	7235-86468	7/8	22.2	1 5/16-12	—	1 1/2	.88	22.4	4.03	102.4	2.84	72.1





## Female JIC 37° Flare Swivel - 90° Bent Tube - Steel

DOT FMVSS 106-74 Type All.

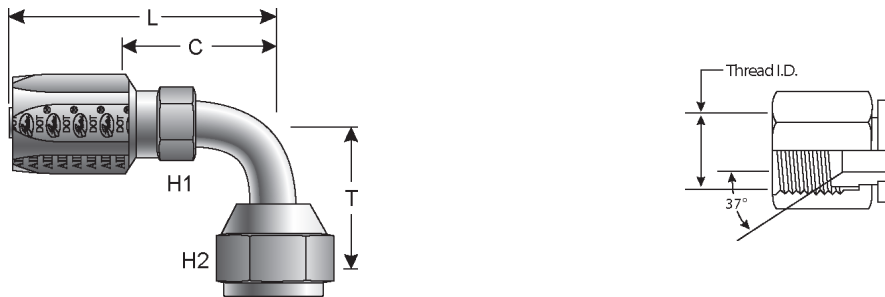

Part No.	Descr.	Prod. No.	⊖		🌀	H1	H2	T		L		C	
			"	mm				"	mm	"	mm	"	mm
G34180-0606	6C5-6RFJX90	7235-86471	5/16	7.9	9/16-18	1/2	11/16	.84	21.3	2.28	57.9	1.33	33.8
G34181-0606	6C5-6RFJX90L	7235-04205	5/16	7.9	9/16-18	1/2	11/16	2.19	55.6	2.28	57.9	1.33	33.8
G34180-1212	12C5X-12RFJX90S	7237-00545	5/8	15.9	1 1/16-12	7/8	1 1/4	1.81	46.0	4.22	107.2	2.66	67.6
G34181-1212	12C5X-12RFJX90L	7237-00555	5/8	15.9	1 1/16-12	7/8	1 1/4	3.75	95.3	4.22	107.2	2.66	67.6
G34180-1616	16C5-16RFJX90	7235-86475	7/8	22.2	1 5/16-12	—	1 1/2	2.16	54.9	3.95	100.3	2.76	70.1
G34181-1616	16C5-16RFJX90L	7235-86482	7/8	22.2	1 5/16-12	—	1 1/2	4.34	110.2	3.95	100.3	2.76	70.1
G34179-2020	20C5-20RFJX90S	7235-20265	1 1/8	28.6	1 5/8-12	—	2	2.75	69.9	5.07	128.8	3.70	94.0
G34181-2020	20C5-20RFJX90L	7235-20255	1 1/8	28.6	1 5/8-12	—	2	5.50	139.7	5.26	133.6	3.89	98.8

## Male SAE 45° Flare - Steel

DOT FMVSS 106-74 Type All.



Part No.	Descr.	Prod. No.	⊖		🌀	H1	L		C	
			"	mm			"	mm	"	mm
G34195-0404	4C5-4RMS	7236-86414	3/16	4.8	7/16-20	1/2	1.76	44.7	1.06	26.9
G34195-0505	5C5X-5RMS	7237-00725	1/4	6.4	1/2-20	1/2	1.96	49.8	1.19	30.2
G34195-0606	6C5-6RMS	7236-86416	5/16	7.9	5/8-18	5/8	2.23	56.6	1.28	32.5
G34195-0808	8C5X-8RMS	7237-00745	13/32	10.3	3/4-16	3/4	2.65	67.3	1.53	38.9
G34195-1010	10C5-10RMS	7236-86418	1/2	12.7	7/8-14	7/8	3.01	76.5	1.72	43.7
G34195-1212	12C5X-12RMS	7237-00765	5/8	15.9	1 1/16-14	1 1/16	3.50	88.9	1.94	49.3

EQUIPMENT
HOSE/CPLG. SELECTION
G8K COUPLINGS
GLOBALSPIRAL COUPLINGS
STAINLESS STEEL SPIRAL
MEGACRIMP COUPLINGS
STAINLESS STEEL BRAID
POWER CRIMP COUPLINGS
FIELD ATTACHABLE G1 & G2 COUPLINGS
FIELD ATTACHABLE C5 COUPLINGS
C14 COUPLINGS
GL COUPLINGS
GLX COUPLINGS
PCTS THERMOPLASTIC COUPLINGS
POLARSEAL COUPLINGS (ACA)
POLARSEAL II COUPLINGS (ACC)
POLARSEAL II COUPLINGS (ACB)
POWER STEERING
ADAPTERS
QUICK DISCONNECT COUPLERS
BALL VALVES
LIVE SWIVEL
ASSEMBLY FABRICATION
ACCESSORIES
EQUIPMENT AND PARTS
KITS
AIR BRAKE HOSE ASSY
BRASS



EQUIPMENT
HOSE/CPLG. SELECTION
G8K COUPLINGS
GLOBAL SPIRAL COUPLINGS
STAINLESS STEEL SPIRAL
MEGACRIMP COUPLINGS
STAINLESS STEEL BRAID
POWER CRIMP COUPLINGS
FIELD ATTACHABLE G1 & G2 COUPLINGS
FIELD ATTACHABLE C5 COUPLINGS
C14 COUPLINGS
GL COUPLINGS
GLX COUPLINGS
PCTS THERMOPLASTIC COUPLINGS
POLARSEAL COUPLINGS (ACA)
POLARSEAL II COUPLINGS (ACC)
POLARSEAL II COUPLINGS (ACB)
POWER STEERING
ADAPTERS
QUICK DISCONNECT COUPLERS
BALL VALVES
LIVE SWIVEL
ASSEMBLY FABRICATION
ACCESSORIES
EQUIPMENT AND PARTS
KITS
AIR BRAKE HOSE ASSY
BRASS

### Female SAE 45° Flare Swivel - Steel

DOT FMVSS 106-74 Type All.

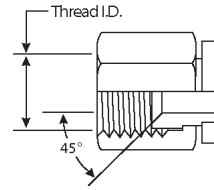
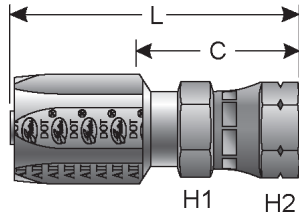

Part No.	Descr.	Prod. No.	⊖		🌀	H1	H2	L		C	
			"	mm				"	mm	"	mm
G34200-0606	6C5-6RFSX	7238-04235	5/16	7.9	5/8-18	3/4	3/4	2.42	61.5	1.47	37.3
G34200-1012	10C5-12RFSX	7238-04335	1/2	12.7	1 1/16-14	1 1/4	1 1/4	3.22	81.8	1.93	49.0
G34200-1212	12C5X-12RFSX	7237-00795	5/8	15.9	1 1/16-14	1 1/4	1 1/4	3.50	88.9	1.94	49.3

### Female SAE 45° Flare Swivel - Brass

DOT FMVSS 106-74 Type All.

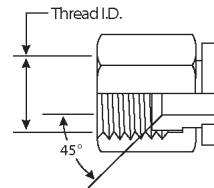
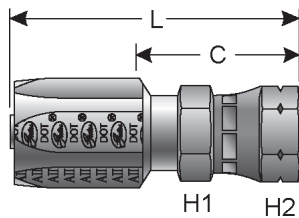

Part No.	Descr.	Prod. No.	⊖		🌀	H1	H2	L		C	
			"	mm				"	mm	"	mm
△ G34200-0606B	6C5-6RFSXB	7238-04045	5/16	7.9	5/8-18	3/4	3/4	2.42	61.5	1.47	37.3
△ G34200-1212B	12C5-12RFSXB	7238-04055	5/8	15.9	1 1/16-14	1 1/4	1 1/4	3.50	88.9	1.94	49.3

△ WARNING: Cancer and Reproductive Harm - www.P65Warnings.ca.gov

### Female SAE 45° Flare Swivel - 45° Bent Tube - Steel

DOT FMVSS 106-74 Type All.

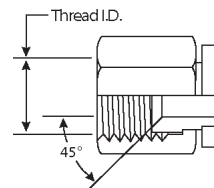
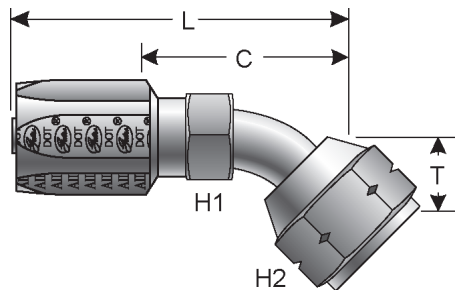

Part No.	Descr.	Prod. No.	⊖		🌀	H1	H2	T	L		C		
			"	mm					"	mm	"	mm	
G34202-0606	6C5-6RFSX45	7235-04855	5/16	7.9	5/8-18	1/2	3/4	.41	10.4	2.42	61.5	1.47	37.3



Female SAE 45° Flare Swivel - 45° Bent Tube - Steel - Continued

Part No.	Descr.	Prod. No.	⊖		H1	H2	T		L		C		
			"	mm			"	"	"	mm	"	mm	"
G34202-1212	12C5X-12RFSX45S	7237-00835	5/8	15.9	1 1/16-14	7/8	1 1/4	.74	18.9	4.27	108.5	2.71	68.8

Female SAE 45° Flare Swivel - 90° Bent Tube - Steel

DOT FMVSS 106-74 Type All.

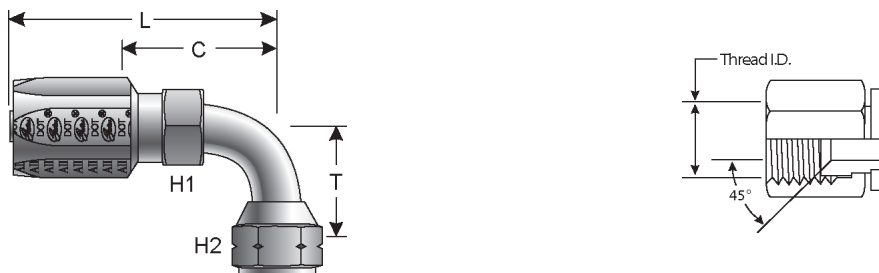

Part No.	Descr.	Prod. No.	⊖		H1	H2	T		L		C		
			"	mm			"	"	"	mm	"	mm	"
G34205-0606	6C5-6RFSX90	7235-04915	5/16	7.9	5/8-18	1/2	3/4	.84	21.3	2.28	57.9	1.33	33.8
G34206-0606	6C5-6RFSX90L	7235-86497	5/16	7.9	5/8-18	1/2	3/4	2.19	55.6	2.28	57.9	1.22	31.0
G34205-1212	12C5X-12RFSX90S	7237-00845	5/8	15.9	1 1/16-14	7/8	1 1/4	1.81	46.0	4.72	119.9	2.66	67.6
G34206-1212	12C5X-12RFSX90L	7237-00855	5/8	15.9	1 1/16-14	7/8	1 1/4	3.75	95.3	4.22	107.2	2.16	54.9

Dual Seat Female JIC 37°/SAE 45° Flare Swivel - Steel

DOT FMVSS 106-74 Type All.

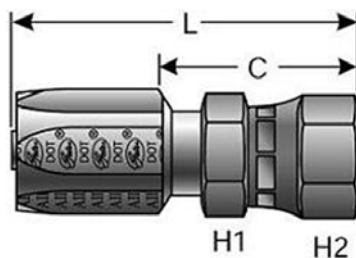

Part No.	Descr.	Prod. No.	⊖		H1	H2	L		C		
			"	mm			"	"	"	mm	"
G34210-0404	4C5-4RFJSX	7238-04215	3/16	4.8	7/16-20	9/16	9/16	1.92	48.8	1.22	31.0
G34210-0504	5C5X-4RFJSX	7237-00875	1/4	6.4	7/16-20	9/16	9/16	2.05	52.1	1.28	32.5
G34210-0505	5C5X-5RFJSX	7237-00885	1/4	6.4	1/2-20	11/16	11/16	2.11	53.6	1.34	34.0
G34210-0608	6C5-8RFJSX	7238-04295	5/16	7.9	3/4-16	7/8	7/8	2.48	63.0	1.53	38.9
G34210-0808	8C5X-8RFJSX	7237-00905	13/32	10.3	3/4-16	7/8	7/8	2.75	69.9	1.63	41.4
G34210-1008	10C5-8RFJSX	7238-04315	1/2	12.7	3/4-16	7/8	7/8	2.93	74.4	1.64	41.7
G34210-1010	10C5-10RFJSX	7238-04255	1/2	12.7	7/8-14	1 1/16	1 1/16	3.10	78.7	1.81	46.0

EQUIPMENT
HOSE/CPLG. SELECTION
G8K COUPLINGS
GLOBALSPIRAL COUPLINGS
STAINLESS STEEL SPIRAL
MEGACRIMP COUPLINGS
STAINLESS STEEL BRAID
POWER CRIMP COUPLINGS
FIELD ATTACHABLE G1 & G2 COUPLINGS
FIELD ATTACHABLE C5 COUPLINGS
C14 COUPLINGS
GL COUPLINGS
GLX COUPLINGS
PCTS THERMOPLASTIC COUPLINGS
POLARSEAL COUPLINGS (ACA)
POLARSEAL II COUPLINGS (ACC)
POLARSEAL II COUPLINGS (ACB)
POWER STEERING
ADAPTERS
QUICK DISCONNECT COUPLERS
BALL VALVES
LIVE SWIVEL
ASSEMBLY FABRICATION
ACCESSORIES
EQUIPMENT AND PARTS
KITS
AIR BRAKE HOSE ASSY
BRASS



## Dual Seat Female JIC 37°/SAE 45° Flare Swivel - Brass

DOT FMVSS 106-74 Type All.

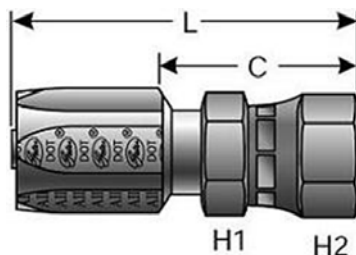

Part No.	Descr.	Prod. No.	⊖		🌀	H1	H2	L		C	
			"	mm				"	mm	"	mm
△ G34210-0505B	5C5-5RFJSXB	7238-04005	1/4	6.4	1/2-20	11/16	11/16	2.11	53.6	1.34	34.0
△ G34210-0808B	8C5-8RFJSXB	7238-04015	13/32	10.3	3/4-16	7/8	7/8	2.75	69.9	1.63	41.4
△ G34210-1010B	10C5-10RFJSXB	7238-04025	1/2	12.7	7/8-14	1 1/16	1 1/16	3.10	78.7	1.81	46.0

⚠️ WARNING: Cancer and Reproductive Harm - www.P65Warnings.ca.gov

## Dual Seat Female JIC 37°/SAE 45° Flare Swivel - 45° Bent Tube - Steel

DOT FMVSS 106-74 Type All.

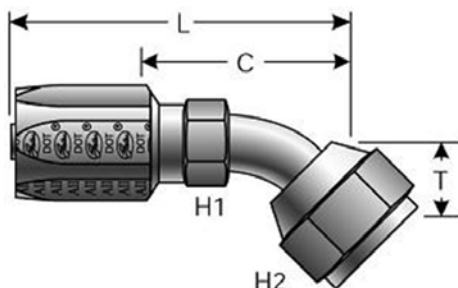

Part No.	Descr.	Prod. No.	⊖		🌀	H1	H2	T	L		C		
			"	mm					"	mm	"	mm	
G34211-0404	4C5-4RFJSX45	7235-20005	3/16	4.8	7/16-20	7/16	9/16	.34	8.6	1.90	48.3	1.21	30.7
G34211-0505	5C5X-5RFJSX45S	7237-00945	1/4	6.4	1/2-20	7/16	5/8	.38	9.7	2.11	53.6	1.34	34.0
G34211-0608	6C5-8RFJSX45	7235-20045	5/16	7.9	3/4-16	5/8	7/8	.56	14.2	2.71	68.8	1.76	44.7
G34211-0808	8C5X-8RFJSX45S	7237-00965	13/32	10.3	3/4-16	5/8	7/8	.56	14.2	2.98	75.7	1.86	47.2
G34211-1010	10C5-10RFJSX45	7235-20035	1/2	12.7	7/8-14	3/4	1	.63	16.0	3.60	91.4	2.31	58.7

EQUIPMENT
HOSE/CPLG. SELECTION
G8K COUPLINGS
GLOBAL SPIRAL COUPLINGS
STAINLESS STEEL SPIRAL
MEGACRIMP COUPLINGS
STAINLESS STEEL BRAID
POWER CRIMP COUPLINGS
FIELD ATTACHABLE G1 & G2 COUPLINGS
FIELD ATTACHABLE C5 COUPLINGS
C14 COUPLINGS
GL COUPLINGS
GLX COUPLINGS
PCTS THERMOPLASTIC COUPLINGS
POLARSEAL COUPLINGS (ACA)
POLARSEAL II COUPLINGS (ACC)
POLARSEAL II COUPLINGS (ACB)
POWER STEERING
ADAPTERS
QUICK DISCONNECT COUPLERS
BALL VALVES
LIVE SWIVEL
ASSEMBLY FABRICATION
ACCESSORIES
EQUIPMENT AND PARTS
KITS
AIR BRAKE HOSE ASSY
BRASS



## Dual Seat Female JIC 37°/SAE 45° Flare Swivel - 90° Bent Tube - Steel

DOT FMVSS 106-74 Type All.

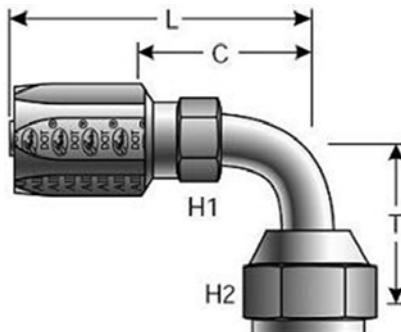

Part No.	Descr.	Prod. No.	⌀		🌀	H1	H2	T		L		C	
			"	mm				"	mm	"	mm	"	mm
G34212-0404	4C5-4RFJSX90	7235-20105	3/16	4.8	7/16-20	7/16	9/16	.69	17.5	1.78	45.2	1.08	27.4
G34213-0404	4C5-4RFJSX90L	7235-20205	3/16	4.8	7/16-20	7/16	9/16	1.81	46.0	1.78	45.2	1.08	27.4
G34212-0505	5C5X-5RFJSX90S	7237-01005	1/4	6.4	1/2-20	7/16	5/8	.78	19.8	2.02	51.3	1.25	31.8
G34213-0505	5C5X-5RFJSX90L	7237-01015	1/4	6.4	1/2-20	7/16	5/8	1.78	45.2	2.02	51.3	1.25	31.8
G34212-0808	8C5X-8RFJSX90S	7237-01025	13/32	10.3	3/4-16	5/8	7/8	1.09	27.7	2.79	70.9	1.67	42.4
G34213-0808	8C5X-8RFJSX90L	7237-01035	13/32	10.3	3/4-16	5/8	7/8	2.44	62.0	2.79	70.9	1.67	42.4
G34212-1010	10C5-10RFJSX90	7235-20135	1/2	12.7	7/8-14	3/4	1	1.25	31.8	3.41	86.6	2.12	53.9
G34213-1010	10C5-10RFJSX90L	7235-20235	1/2	12.7	7/8-14	3/4	1	2.56	65.0	3.41	86.6	2.12	53.9

## Female Flat-Face Swivel - Steel

DOT FMVSS 106-74 Type All.  
SAE J1453 O-Ring Face Seal.



Part No.	Descr.	Prod. No.	⌀		🌀	H1	H2	L		C	
			"	mm				"	mm	"	mm
G34230-0404	4C5-4RFFORX	7238-01505	3/16	4.8	9/16-18	9/16	11/16	2.07	52.6	1.32	33.5
G34230-0606	6C5-6RFFORX	7238-01265	5/16	7.9	11/16-16	1/2	13/16	2.53	64.3	1.58	40.1
G34230-0808	8C5X-8RFFORX	7237-01085	13/32	10.3	13/16-16	13/16	15/16	2.92	74.2	1.77	45.0
G34230-1010	10C5-10RFFORX	7238-01545	1/2	12.7	1-14	15/16	1 1/8	3.23	82.0	1.94	49.3
G34230-1212	12C5X-12RFFORX	7237-01105	5/8	15.9	1 3/16-12	7/8	1 3/8	3.70	94.0	2.12	53.9

- EQUIPMENT
- HOSE/CPLG. SELECTION
- G8K COUPLINGS
- GLOBALSPIRAL COUPLINGS
- STAINLESS STEEL SPIRAL
- MEGACRIMP COUPLINGS
- STAINLESS STEEL BRAID
- POWER CRIMP COUPLINGS
- FIELD ATTACHABLE G1 & G2 COUPLINGS
- FIELD ATTACHABLE C5 COUPLINGS
- C14 COUPLINGS
- GL COUPLINGS
- GLX COUPLINGS
- PCTS THERMOPLASTIC COUPLINGS
- POLARSEAL COUPLINGS (ACA)
- POLARSEAL II COUPLINGS (ACC)
- POLARSEAL II COUPLINGS (ACB)
- POWER STEERING
- ADAPTERS
- QUICK DISCONNECT COUPLERS
- BALL VALVES
- LIVE SWIVEL
- ASSEMBLY FABRICATION
- ACCESSORIES
- EQUIPMENT AND PARTS
- KITS
- AIR BRAKE HOSE ASSY
- BRASS



EQUIPMENT
HOSE/CPLG. SELECTION
G8K COUPLINGS
GLOBALSPIRAL COUPLINGS
STAINLESS STEEL SPIRAL
MEGACRIMP COUPLINGS
STAINLESS STEEL BRAID
POWER CRIMP COUPLINGS
FIELD ATTACHABLE G1 & G2 COUPLINGS
FIELD ATTACHABLE C5 COUPLINGS
C14 COUPLINGS
GL COUPLINGS
GLX COUPLINGS
PCTS THERMOPLASTIC COUPLINGS
POLARSEAL COUPLINGS (ACA)
POLARSEAL II COUPLINGS (ACC)
POLARSEAL II COUPLINGS (ACB)
POWER STEERING
ADAPTERS
QUICK DISCONNECT COUPLERS
BALL VALVES
LIVE SWIVEL
ASSEMBLY FABRICATION
ACCESSORIES
EQUIPMENT AND PARTS
KITS
AIR BRAKE HOSE ASSY
BRASS

### Female Flat-Face Swivel - 45° Bent Tube - Steel

DOT FMVSS 106-74 Type All.  
SAE J1453 O-Ring Face Seal.

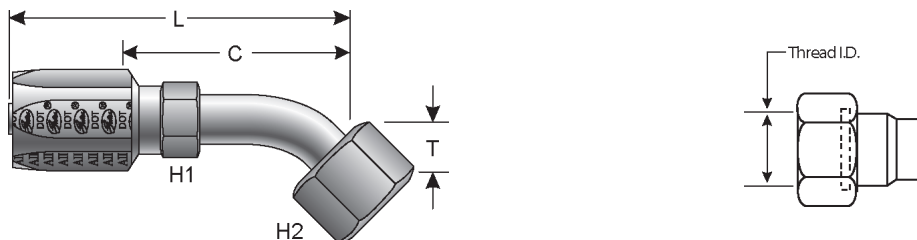

Part No.	Descr.	Prod. No.	⌀		H1	H2	T		L		C		
			"	mm			"	mm	"	mm	"	mm	
G34235-0404	4C5-4RFFORX45	7235-05275	3/16	4.8	9/16-18	1/2	11/16	.41	10.4	2.42	61.5	1.67	42.4

### Female Flat-Face Swivel - 90° Bent Tube - Steel

DOT FMVSS 106-74 Type All.  
SAE J1453 O-Ring Face Seal.

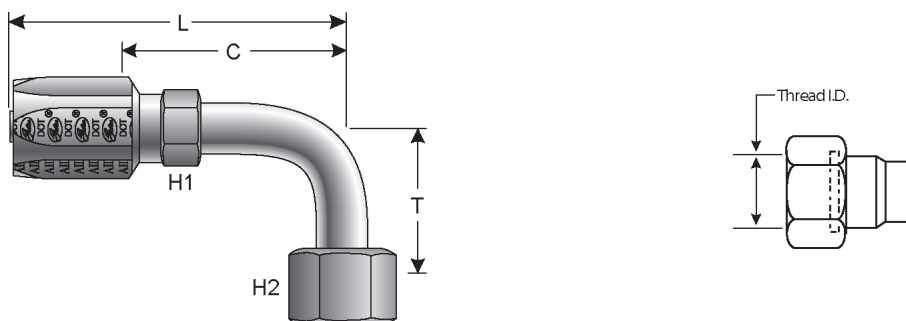

Part No.	Descr.	Prod. No.	⌀		H1	H2	T		L		C		
			"	mm			"	mm	"	mm	"	mm	
G34240-0404	4C5-4RFFORX90	7235-05285	3/16	4.8	9/16-18	1/2	11/16	.82	20.8	2.17	55.1	1.42	36.1
G34239-0606	6C5-6RFFORX90S	7235-05305	5/16	7.9	11/16-16	1/2	13/16	.90	22.9	2.77	70.4	1.82	46.2



## Special Flange - 90° - Engine Oil Connection (Code 61 2-Bolt)

DOT FMVSS 106-74 Type All.

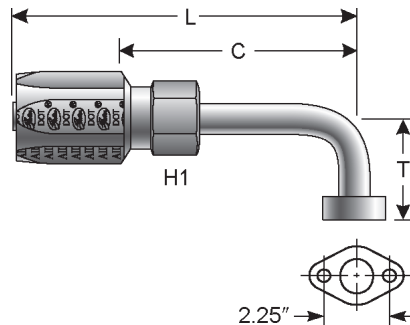

Part No.	Descr.	Prod. No.	⊖		H1	T	L	C			
			"	mm				"	mm		
G34342-2020	20C5-20RFL90S	7235-20275	1 1/8	28.6	1 9/16	2.50	63.5	4.95	125.7	3.95	100.3

## Male SAE 45° Flare Inverted Swivel - Steel

DOT FMVSS 106-74 Type All.



Part No.	Descr.	Prod. No.	⊖		H1	H2	L	C			
			"	mm				"	mm		
G34500-0404	4C5-4RMIX	7235-86372	3/16	4.8	7/16-24	7/16	7/16	2.41	61.2	1.72	43.7
G34500-0505	5C5X-5RMIX	7237-01155	1/4	6.4	1/2-20	7/16	1/2	2.63	66.8	1.84	46.7
G34500-0506	5C5X-6RMIX	7237-01165	1/4	6.4	5/8-18	1/2	5/8	2.59	65.8	1.82	46.2
G34500-0605	6C5-5RMIX	7235-01035	5/16	7.9	1/2-20	1/2	1/2	2.60	66.0	1.65	41.9
G34500-0606	6C5-6RMIX	7235-86382	5/16	7.9	5/8-18	1/2	5/8	2.86	72.6	1.91	48.5
G34500-0608	6C5-8RMIX	7235-01055	5/16	7.9	3/4-18	5/8	3/4	3.23	82.0	2.28	57.9
G34500-0806	8C5X-6RMIX	7237-01205	13/32	10.3	5/8-18	5/8	5/8	3.13	79.5	2.01	51.1
G34500-0808	8C5X-8RMIX	7237-01215	13/32	10.3	3/4-18	5/8	3/4	3.49	88.7	2.37	60.2

EQUIPMENT
HOSE/CPLG. SELECTION
G8K COUPLINGS
GLOBALSPIRAL COUPLINGS
STAINLESS STEEL SPIRAL
MEGACRIMP COUPLINGS
STAINLESS STEEL BRAID
POWER CRIMP COUPLINGS
FIELD ATTACHABLE G1 & G2 COUPLINGS
FIELD ATTACHABLE C5 COUPLINGS
C14 COUPLINGS
GL COUPLINGS
GLX COUPLINGS
PCTS THERMOPLASTIC COUPLINGS
POLARSEAL COUPLINGS (ACA)
POLARSEAL II COUPLINGS (ACC)
POLARSEAL II COUPLINGS (ACB)
POWER STEERING
ADAPTERS
QUICK DISCONNECT COUPLERS
BALL VALVES
LIVE SWIVEL
ASSEMBLY FABRICATION
ACCESSORIES
EQUIPMENT AND PARTS
KITS
AIR BRAKE HOSE ASSY
BRASS





EQUIPMENT
HOSE/CPLG. SELECTION
G8K COUPLINGS
GLOBAL SPIRAL COUPLINGS
STAINLESS STEEL SPIRAL
MEGACRIMP COUPLINGS
STAINLESS STEEL BRAID
POWER CRIMP COUPLINGS
FIELD ATTACHABLE G1 & G2 COUPLINGS
FIELD ATTACHABLE C5 COUPLINGS
C14 COUPLINGS
GL COUPLINGS
GLX COUPLINGS
PCTS THERMOPLASTIC COUPLINGS
POLARSEAL COUPLINGS (ACA)
POLARSEAL II COUPLINGS (ACC)
POLARSEAL II COUPLINGS (ACB)
POWER STEERING
ADAPTERS
QUICK DISCONNECT COUPLERS
BALL VALVES
LIVE SWIVEL
ASSEMBLY FABRICATION
ACCESSORIES
EQUIPMENT AND PARTS
KITS
AIR BRAKE HOSE ASSY
BRASS

## Male SAE 45° Flare Inverted Swivel - 45° Bent Tube - Steel

DOT FMVSS 106-74 Type All.

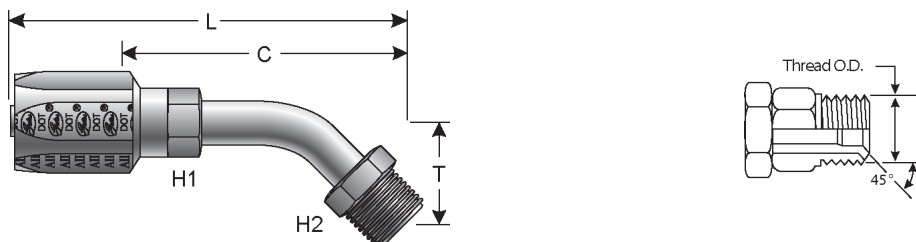

Part No.	Descr.	Prod. No.	⌀		H1	H2	T		L		C		
			"	mm			"	mm	"	mm	"	mm	
G34502-0404	4C5-4RMIX45	7235-05005	3/16	4.8	7/16-24	7/16	7/16	.62	15.8	2.18	55.4	1.48	37.6
G34502-0606	6C5-6RMIX45	7235-05015	5/16	7.9	5/8-18	1/2	5/8	.94	23.9	3.03	77.0	2.09	53.1
G34502-0808	8C5X-8RMIX45-028	7237-01245	13/32	10.3	3/4-18	5/8	3/4	1.09	27.7	3.44	87.4	2.32	58.9

## Male SAE 45° Flare Inverted Swivel - 90° Bent Tube - Steel

DOT FMVSS 106-74 Type All.

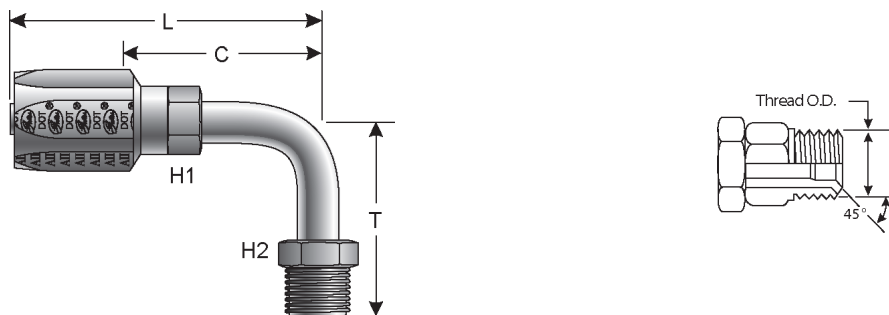

Part No.	Descr.	Prod. No.	⌀		H1	H2	T		L		C		
			"	mm			"	mm	"	mm	"	mm	
G34504-0404	4C5-4RMIX90	7235-05105	3/16	4.8	7/16-24	7/16	7/16	1.56	39.6	2.17	55.1	1.47	37.3
G34504-0505	5C5X-5RMIX90-042	7237-01265	1/4	6.4	1/2-20	7/16	1/2	1.66	42.2	2.43	61.7	1.66	42.2
G34504-0606	6C5-6RMIX90	7235-86387	5/16	7.9	5/8-18	1/2	5/8	1.69	42.9	2.64	67.1	1.69	42.9
G34504-0608	6C5-8RMIX90	7235-05135	5/16	7.9	3/4-18	5/8	3/4	1.78	45.2	2.73	69.3	1.78	45.2
G34504-0806	8C5X-6RMIX90-043	7237-01295	13/32	10.3	5/8-18	5/8	5/8	1.69	42.9	2.81	71.4	1.69	42.9
G34504-0808	8C5X-8RMIX90-045	7237-01305	13/32	10.3	3/4-18	5/8	3/4	1.78	45.2	2.90	73.7	1.78	45.2



## SAE Male Flareless Assembly - Steel

DOT FMVSS 106-74 Type All.

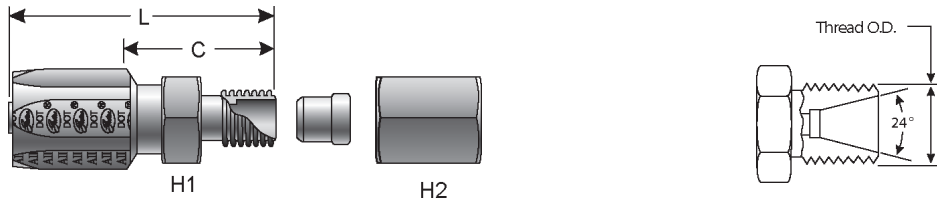

Part No.	Descr.	Prod. No.	⌀		H1	H2	L		C		
			"	mm			"	"	"	mm	"
G34510-0404	4C5-4RMFA	7236-04855	3/16	4.8	7/16-20	1/2	9/16	1.81	46.0	1.06	26.9
G34510-0505	5C5X-5RMFA	7237-01325	1/4	6.4	1/2-20	9/16	5/8	1.91	48.5	1.12	28.5
G34510-0604	6C5-4RMFA	7236-04875	5/16	7.9	7/16-20	9/16	9/16	2.03	51.6	1.13	28.7
G34510-0606	6C5-6RMFA	7236-04885	5/16	7.9	9/16-18	5/8	11/16	2.05	52.1	1.15	29.2
G34510-0808	8C5X-8RMFA	7237-01355	13/32	10.3	3/4-16	13/16	7/8	2.52	64.0	1.37	34.8
G34510-1010	10C5-10RMFA	7236-04905	1/2	12.7	7/8-14	15/16	1	2.77	70.4	1.48	37.6

## Female Air Brake Swivel - Steel

DOT FMVSS 106-74 Type All.

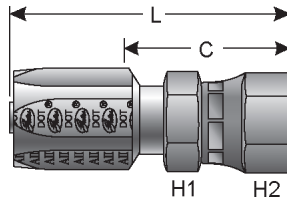

Part No.	Descr.	Prod. No.	⌀		H1	H2	L		C		
			"	mm			"	"	"	mm	"
G34540-0606	6C5-6RFABX	7238-04425	5/16	7.9	3/4-20	7/8	7/8	2.29	58.2	1.34	34.0
G34540-0806	8C5X-6RFABX	7237-01395	13/32	10.3	3/4-20	7/8	7/8	2.60	66.0	1.48	37.6

## Parker Triple Thread Female Swivel - Steel

DOT FMVSS 106-74 Type All.



Part No.	Descr.	Prod. No.	⌀		H1	H2	L		C		
			"	mm			"	"	"	mm	"
G34562-1616	16C5-16RFZX	7238-86461	7/8	22.2	1 5/16-14	1 1/2	1 1/2	2.90	73.7	1.72	43.7

EQUIPMENT
HOSE/CPLG. SELECTION
G8K COUPLINGS
GLOBALSPIRAL COUPLINGS
STAINLESS STEEL SPIRAL
MEGACRIMP COUPLINGS
STAINLESS STEEL BRAID
POWER CRIMP COUPLINGS
FIELD ATTACHABLE G1 & G2 COUPLINGS
FIELD ATTACHABLE C5 COUPLINGS
C14 COUPLINGS
GL COUPLINGS
GLX COUPLINGS
PCTS THERMOPLASTIC COUPLINGS
POLARSEAL COUPLINGS (ACA)
POLARSEAL II COUPLINGS (ACC)
POLARSEAL II COUPLINGS (ACB)
POWER STEERING
ADAPTERS
QUICK DISCONNECT COUPLERS
BALL VALVES
LIVE SWIVEL
ASSEMBLY FABRICATION
ACCESSORIES
EQUIPMENT AND PARTS
KITS
AIR BRAKE HOSE ASSY
BRASS



## Male Pipe (NPTF - 30° Cone Seat) - Steel

DOT FMVSS Type A1 (No mandrel required).

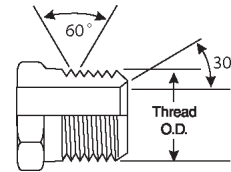
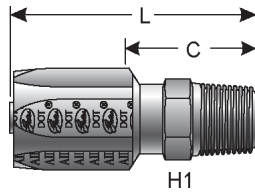

Part No.	Descr.	Prod. No.	⊖		🌀	H1	L		C	
			"	mm			"	mm	"	mm
G35100-0402	4C5E-2RMP	7236-00755	3/16	4.8	1/8-27	1/2	1.53	38.9	.81	20.6
G35100-0404	4C5E-4RMP	7236-00765	3/16	4.8	1/4-18	9/16	1.75	44.5	1.03	26.2
G35100-0504	5C5E-4RMP	7236-00775	1/4	6.4	1/4-18	9/16	1.76	44.7	.96	24.4
G35100-0604	6C5E-4RMP	7236-00785	5/16	7.9	1/4-18	9/16	1.85	47.0	1.00	25.4
G35100-0606	6C5E-6RMP	7236-00795	5/16	7.9	3/8-18	11/16	1.89	48.0	1.04	26.4
G35100-0806	8C5E-6RMP	7236-00805	13/32	10.3	3/8-18	11/16	2.19	55.6	1.19	30.2
G35100-0808	8C5E-8RMP	7236-00815	13/32	10.3	1/2-14	7/8	2.29	58.2	1.29	32.8
G35100-1008	10C5E-8RMP	7236-00825	1/2	12.7	1/2-14	7/8	2.38	60.5	1.31	33.3
G35100-1212	12C5E-12RMP	7236-00835	5/8	15.9	3/4-14	1 1/16	2.59	65.8	1.44	36.6
G35100-1216	12C5E-16RMP	7236-00845	5/8	15.9	1-11 1/2	1 3/8	2.87	72.9	1.72	43.7
G35100-1612	16C5E-12RMP	7236-00865	7/8	22.2	3/4-14	1 1/16	2.49	63.3	1.43	36.3
G35100-1616	16C5E-16RMP	7236-00855	7/8	22.2	1-11 1/2	1 3/8	2.80	71.1	1.74	44.2
G35100-2020	20C5E-20RMP	7236-00885	1 1/8	28.6	1 1/4-11 1/2	1 3/4	2.92	74.2	1.80	45.7

## Female JIC 37° Flare Swivel - Steel

DOT FMVSS Type A1 (No mandrel required).

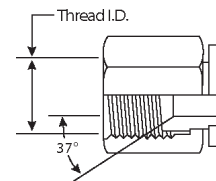
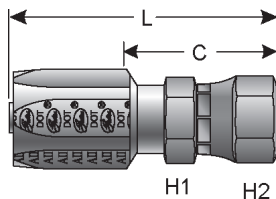

Part No.	Descr.	Prod. No.	⊖		🌀	H1	H2	L		C	
			"	mm				"	mm	"	mm
G35170-0606	6C5E-6RFJX	7238-01025	5/16	7.9	9/16-18	3/4	3/4	2.04	51.8	1.19	30.2
G35170-1212	12C5E-12RFJX	7238-01055	5/8	15.9	1 1/16-12	1 1/4	1 1/4	2.92	74.2	1.78	45.2
G35170-1616	16C5E-16RFJX	7238-01065	7/8	22.2	1 5/16-12	1 1/2	1 1/2	2.90	73.7	1.84	46.7
G35170-2020	20C5E-20RFJX	7238-01215	1 1/8	28.6	1 5/8-12	1 9/16	2	3.34	84.8	2.20	55.9



## Female JIC 37° Flare Swivel - 45° Bent Tube - Steel

DOT FMVSS Type A1 (No mandrel required).

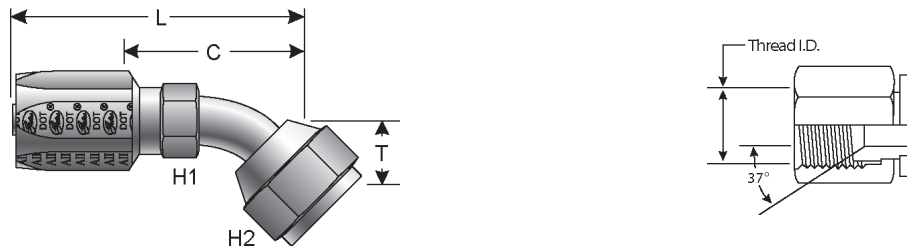

Part No.	Descr.	Prod. No.	⊖		H1	H2	T		L		C		
			"	mm			"	"	"	mm	"	mm	"
G35175-0606	6C5E-6RFJX45	7235-20415	5/16	7.9	9/16-18	1/2	11/16	.41	10.4	2.33	59.2	1.48	37.6
G35175-1212	12C5E-12RFJX45	7235-20455	5/8	15.9	1 1/16-12	7/8	1 1/4	.78	19.8	3.63	92.2	2.49	63.3

## Female JIC 37° Flare Swivel - 90° Bent Tube - Steel

DOT FMVSS Type A1 (No mandrel required).

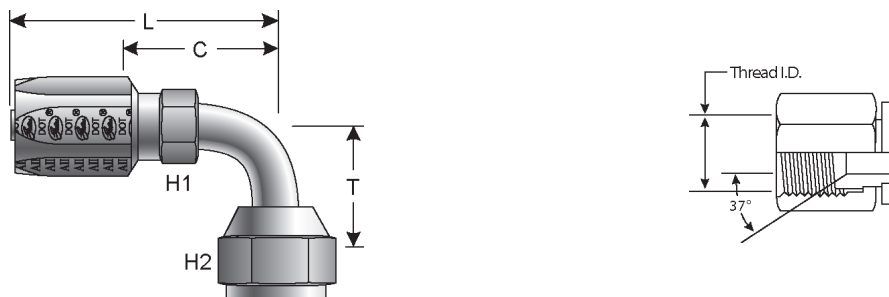

Part No.	Descr.	Prod. No.	⊖		H1	H2	T		L		C		
			"	mm			"	"	"	mm	"	mm	"
G35180-0606	6C5E-6RFJX90	7235-00305	5/16	7.9	9/16-18	1/2	11/16	.91	23.4	2.21	56.1	1.78	45.2
G35180-1212	12C5E-12RFJX90	7235-00265	5/8	15.9	1 1/16-12	7/8	1 1/4	1.81	46.0	3.58	90.9	2.44	62.0
G35180-1616	16C5E-16RFJX90	7235-00285	7/8	22.2	1 5/16-12	—	1 1/2	2.16	54.9	3.72	94.5	2.66	67.6
G35180-2020	20C5E-20RFJX90	7235-20345	1 1/8	28.6	1 5/8-12	2	1 9/16	2.65	67.3	5.58	141.7	4.45	113.0

EQUIPMENT
HOSE/CPLG. SELECTION
G8K COUPLINGS
GLOBALSPIRAL COUPLINGS
STAINLESS STEEL SPIRAL
MEGACRIMP COUPLINGS
STAINLESS STEEL BRAID
POWER CRIMP COUPLINGS
FIELD ATTACHABLE G1 & G2 COUPLINGS
FIELD ATTACHABLE C5 COUPLINGS
C14 COUPLINGS
GL COUPLINGS
GLX COUPLINGS
PCTS THERMOPLASTIC COUPLINGS
POLARSEAL COUPLINGS (ACA)
POLARSEAL II COUPLINGS (ACC)
POLARSEAL II COUPLINGS (ACB)
POWER STEERING
ADAPTERS
QUICK DISCONNECT COUPLERS
BALL VALVES
LIVE SWIVEL
ASSEMBLY FABRICATION
ACCESSORIES
EQUIPMENT AND PARTS
KITS
AIR BRAKE HOSE ASSY
BRASS



EQUIPMENT
HOSE/CPLG. SELECTION
G8K COUPLINGS
GLOBALSPIRAL COUPLINGS
STAINLESS STEEL SPIRAL
MEGACRIMP COUPLINGS
STAINLESS STEEL BRAID
POWER CRIMP COUPLINGS
FIELD ATTACHABLE G1 & G2 COUPLINGS
FIELD ATTACHABLE C5 COUPLINGS
C14 COUPLINGS
GL COUPLINGS
GLX COUPLINGS
PCTS THERMOPLASTIC COUPLINGS
POLARSEAL COUPLINGS (ACA)
POLARSEAL II COUPLINGS (ACC)
POLARSEAL II COUPLINGS (ACB)
POWER STEERING
ADAPTERS
QUICK DISCONNECT COUPLERS
BALL VALVES
LIVE SWIVEL
ASSEMBLY FABRICATION
ACCESSORIES
EQUIPMENT AND PARTS
KITS
AIR BRAKE HOSE ASSY
BRASS

### Female SAE 45° Flare Swivel - Steel

DOT FMVSS Type A1 (No mandrel required).

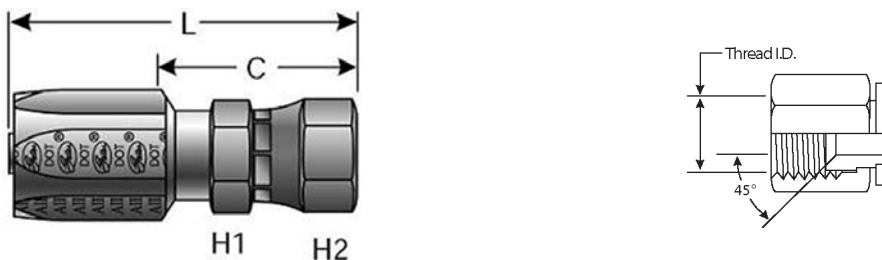

Part No.	Descr.	Prod. No.	⊖		H1	H2	L		C		
			"	mm			"	mm	"	mm	
G35200-0606	6C5E-6RFSX	7238-00955	5/16	7.9	5/8-18	3/4	3/4	2.13	54.1	1.28	32.5
G35200-1212	12C5E-12RFSX	7238-00985	5/8	15.9	1 1/16-14	1 1/4	1 1/4	2.94	74.7	1.80	45.7

### Female SAE 45° Flare Swivel - 45° Bent Tube - Steel

DOT FMVSS Type A1 (No mandrel required).

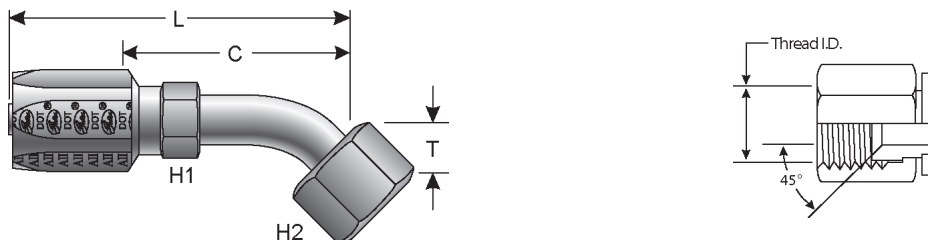

Part No.	Descr.	Prod. No.	⊖		H1	H2	T	L		C			
			"	mm				"	mm	"	mm		
G35202-0606	6C5E-6RFSX45	7235-20425	5/16	7.9	5/8-18	1/2	3/4	.41	10.4	2.33	59.2	1.48	37.6
G35202-1212	12C5E-12RFSX45	7235-20465	5/8	15.9	1 1/16-14	7/8	1 1/4	.78	19.8	3.63	92.2	2.49	63.3



## Female SAE 45° Flare Swivel - 90° Bent Tube - Steel

DOT FMVSS Type A1 (No mandrel required).

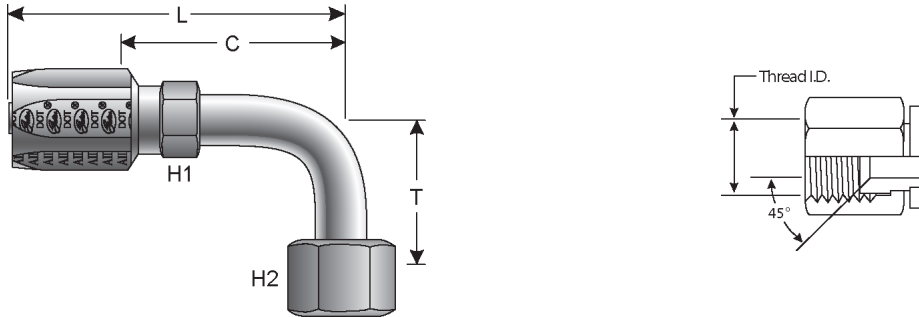

Part No.	Descr.	Prod. No.	⌀		H1	H2	T		L		C		
			"	mm			"	mm	"	mm	"	mm	
G35205-0606	6C5E-6RFSX90	7235-00315	5/16	7.9	5/8-18	1/2	3/4	.84	21.3	2.21	56.1	1.36	34.5
G35205-1212	12C5E-12RFSX90	7235-00275	5/8	15.9	1 1/16-14	7/8	1 1/4	1.81	46.0	3.58	90.9	2.44	62.0

## Dual Seat Female JIC 37°/SAE 45° Flare Swivel - Steel

DOT FMVSS Type A1 (No mandrel required).

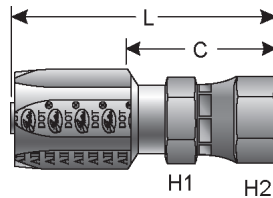

Part No.	Descr.	Prod. No.	⌀		H1	H2	L		C		
			"	mm			"	mm	"	mm	
G35210-0404	4C5E-4RFJSX	7238-01005	3/16	4.8	7/16-20	1/2	9/16	1.82	46.2	1.10	27.9
G35210-0505	5C5E-5RFJSX	7238-01015	1/4	6.4	1/2-20	1/2	11/16	2.00	50.8	1.21	30.7
G35210-0808	8C5E-8RFJSX	7238-01035	13/32	10.3	3/4-16	7/8	7/8	2.45	62.2	1.45	36.8
G35210-1010	10C5E-10RFJSX	7238-01045	1/2	12.7	7/8-14	1 1/16	1 1/16	2.72	69.1	1.65	41.9

EQUIPMENT
HOSE/CPLG. SELECTION
G8K COUPLINGS
GLOBALSPIRAL COUPLINGS
STAINLESS STEEL SPIRAL
MEGACRIMP COUPLINGS
STAINLESS STEEL BRAID
POWER CRIMP COUPLINGS
FIELD ATTACHABLE G1 & G2 COUPLINGS
FIELD ATTACHABLE C5 COUPLINGS
C14 COUPLINGS
GL COUPLINGS
GLX COUPLINGS
PCTS THERMOPLASTIC COUPLINGS
POLARSEAL COUPLINGS (ACA)
POLARSEAL II COUPLINGS (ACC)
POLARSEAL II COUPLINGS (ACB)
POWER STEERING
ADAPTERS
QUICK DISCONNECT COUPLERS
BALL VALVES
LIVE SWIVEL
ASSEMBLY FABRICATION
ACCESSORIES
EQUIPMENT AND PARTS
KITS
AIR BRAKE HOSE ASSY
BRASS



EQUIPMENT
HOSE/CPLG. SELECTION
G8K COUPLINGS
GLOBAL SPIRAL COUPLINGS
STAINLESS STEEL SPIRAL
MEGACRIMP COUPLINGS
STAINLESS STEEL BRAID
POWER CRIMP COUPLINGS
FIELD ATTACHABLE G1 & G2 COUPLINGS
FIELD ATTACHABLE C5 COUPLINGS
C14 COUPLINGS
GL COUPLINGS
GLX COUPLINGS
PCTS THERMOPLASTIC COUPLINGS
POLARSEAL COUPLINGS (ACA)
POLARSEAL II COUPLINGS (ACC)
POLARSEAL II COUPLINGS (ACB)
POWER STEERING
ADAPTERS
QUICK DISCONNECT COUPLERS
BALL VALVES
LIVE SWIVEL
ASSEMBLY FABRICATION
ACCESSORIES
EQUIPMENT AND PARTS
KITS
AIR BRAKE HOSE ASSY
BRASS

## Dual Seat Female JIC 37°/SAE 45° Flare Swivel - 45° Bent Tube - Steel

DOT FMVSS Type A1 (No mandrel required).

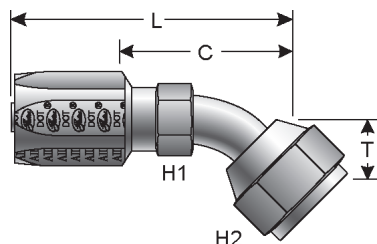

Part No.	Descr.	Prod. No.	⌀		7/16-20	H1	H2	T		L		C	
			"	mm				"	mm	"	mm	"	mm
G35211-0404	4C5E-4RFJSX45	7235-20405	3/16	4.8	7/16-20	1/2	9/16	.34	8.6	1.92	48.8	1.20	30.5
G35211-0808	8C5E-8RFJSX45	7235-20435	13/32	10.3	3/4-16	11/16	7/8	.56	14.2	2.73	69.3	1.73	43.9
G35211-1010	10C5E-10RFJSX45	7235-20445	1/2	12.7	7/8-14	3/4	1	.63	16.0	3.17	80.5	2.11	53.6

## Dual Seat Female JIC 37°/SAE 45° Flare Swivel - 90° Bent Tube - Steel

DOT FMVSS Type A1 (No mandrel required).

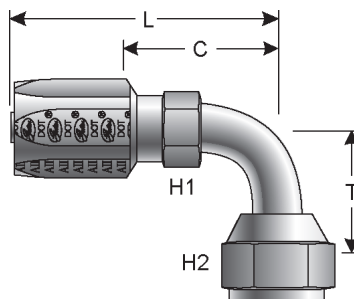

Part No.	Descr.	Prod. No.	⌀		7/16-20	H1	H2	T		L		C	
			"	mm				"	mm	"	mm	"	mm
G35212-0404	4C5E-4RFJSX90	7235-20305	3/16	4.8	7/16-20	1/2	9/16	.69	17.5	1.72	43.7	1.00	25.4
G35212-0808	8C5E-8RFJSX90	7235-20315	13/32	10.3	3/4-16	11/16	7/8	1.09	27.7	2.54	64.5	1.54	39.1
G35212-1010	10C5E-10RFJSX90	7235-20325	1/2	12.7	7/8-14	3/4	1	1.25	31.8	2.97	75.4	1.91	48.5





## Special Flange - 90° - Engine Oil Connection (Code 61 2-Bolt) - Steel

DOT FMVSS Type A1 (No mandrel required).

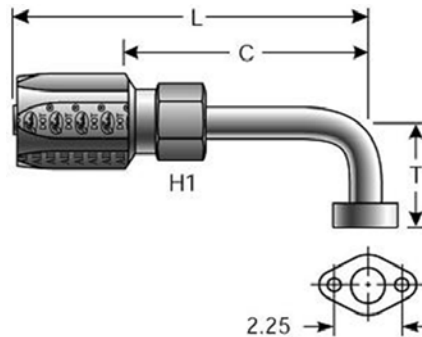

Part No.	Descr.	Prod. No.	⊖		H1	T		L		C	
			"	mm		"	mm	"	mm	"	mm
G35342-2020	20C5E-20RFL90S	7235-20355	1 1/8	28.6	1 9/16	2.50	63.5	4.95	125.7	3.82	97.0

## Male SAE 45° Flare Inverted Swivel - Steel

DOT FMVSS Type A1 (No mandrel required).



Part No.	Descr.	Prod. No.	⊖		H1	H2	L		C		
			"	mm			"	mm	"	mm	
G35500-0404	4C5E-4RMIX	7235-02855	3/16	4.8	7/16-24	1/2	7/16	2.05	52.1	1.33	33.8
G35500-0505	5C5E-5RMIX	7235-02865	1/4	6.4	1/2-20	1/2	1/2	2.26	57.4	1.45	36.8
G35500-0605	6C5E-5RMIX	7235-02875	5/16	7.9	1/2-20	1/2	1/2	2.39	60.7	1.54	39.1
G35500-0606	6C5E-6RMIX	7235-02885	5/16	7.9	5/8-18	1/2	5/8	2.71	68.8	1.86	47.2
G35500-0808	8C5E-8RMIX	7235-02895	13/32	10.3	3/4-18	11/16	3/4	3.24	82.3	2.24	56.9

- EQUIPMENT
- HOSE/CPLG. SELECTION
- G8K COUPLINGS
- GLOBALSPIRAL COUPLINGS
- STAINLESS STEEL SPIRAL
- MEGACRIMP COUPLINGS
- STAINLESS STEEL BRAID
- POWER CRIMP COUPLINGS
- FIELD ATTACHABLE G1 & G2 COUPLINGS
- FIELD ATTACHABLE C5 COUPLINGS
- C14 COUPLINGS
- GL COUPLINGS
- GLX COUPLINGS
- PCTS THERMOPLASTIC COUPLINGS
- POLARSEAL COUPLINGS (ACA)
- POLARSEAL II COUPLINGS (ACC)
- POLARSEAL II COUPLINGS (ACB)
- POWER STEERING
- ADAPTERS
- QUICK DISCONNECT COUPLERS
- BALL VALVES
- LIVE SWIVEL
- ASSEMBLY FABRICATION
- ACCESSORIES
- EQUIPMENT AND PARTS
- KITS
- AIR BRAKE HOSE ASSY
- BRASS



EQUIPMENT
HOSE/CPLG. SELECTION
G8K COUPLINGS
GLOBAL SPIRAL COUPLINGS
STAINLESS STEEL SPIRAL
MEGACRIMP COUPLINGS
STAINLESS STEEL BRAID
POWER CRIMP COUPLINGS
FIELD ATTACHABLE G1 & G2 COUPLINGS
FIELD ATTACHABLE C5 COUPLINGS
C14 COUPLINGS
GL COUPLINGS
GLX COUPLINGS
PCTS THERMOPLASTIC COUPLINGS
POLARSEAL COUPLINGS (ACA)
POLARSEAL II COUPLINGS (ACC)
POLARSEAL II COUPLINGS (ACB)
POWER STEERING
ADAPTERS
QUICK DISCONNECT COUPLERS
BALL VALVES
LIVE SWIVEL
ASSEMBLY FABRICATION
ACCESSORIES
EQUIPMENT AND PARTS
KITS
AIR BRAKE HOSE ASSY
BRASS

## Male SAE 45° Flare Inverted Swivel - 45° Bent Tube - Steel

DOT FMVSS Type A1 (No mandrel required).

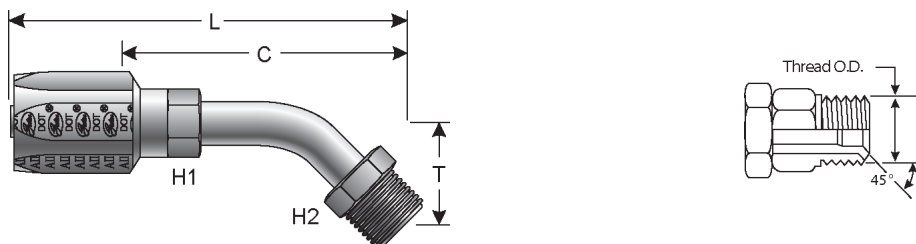

Part No.	Descr.	Prod. No.	⌀		H1	H2	T		L		C		
			"	mm			"	mm	"	mm	"	mm	
G35502-0606	6C5E-6RMIX45	7235-02795	5/16	7.9	5/8-18	1/2	5/8	.84	21.3	3.79	96.3	2.94	74.7
G35502-0808	8C5E-8RMIX45	7235-02905	13/32	10.3	3/4-18	11/16	3/4	1.09	27.7	4.24	107.7	3.24	82.3

## Male SAE 45° Flare Inverted Swivel - 90° Bent Tube - Steel

DOT FMVSS Type A1 (No mandrel required).

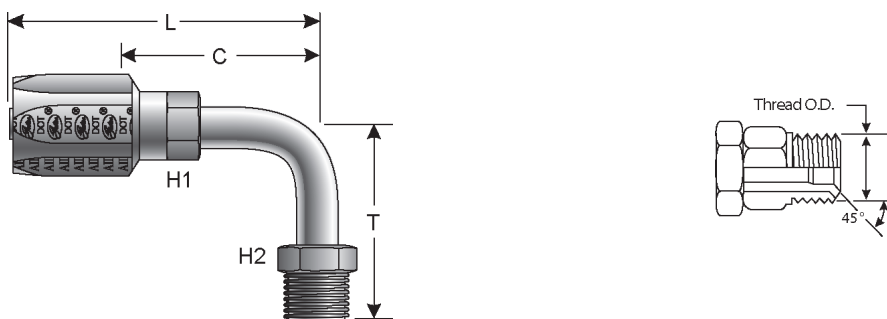

Part No.	Descr.	Prod. No.	⌀		H1	H2	T		L		C		
			"	mm			"	mm	"	mm	"	mm	
G35504-0404	4C5E-4RMIX90	7235-02805	3/16	4.8	7/16-24	1/2	7/16	1.25	31.8	2.05	52.1	1.33	33.8
G35504-0505	5C5E-5RMIX90	7235-02815	1/4	6.4	1/2-20	1/2	1/2	1.50	38.1	2.25	57.2	1.46	37.1
G35504-0605	6C5E-5RMIX90	7235-02825	5/16	7.9	1/2-20	1/2	1/2	1.50	38.1	2.39	60.7	1.54	39.1
G35504-0606	6C5E-6RMIX90	7235-02835	5/16	7.9	5/8-18	1/2	5/8	1.63	41.4	2.71	68.8	1.86	47.2
G35504-0808	8C5E-8RMIX90	7235-02845	13/32	10.3	3/4-18	11/16	3/4	2.00	50.8	3.24	82.3	2.24	56.9



### SAE Male Flareless Assembly - Steel

DOT FMVSS Type A1 (No mandrel required).

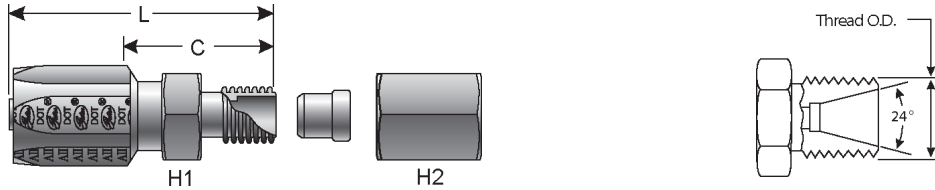

Part No.	Descr.	Prod. No.	⊖		🌀	H1	H2	L		C	
			"	mm				"	mm	"	mm
G35510-0404	4C5E-4RMFA	7236-04955	3/16	4.8	7/16-20	1/2	9/16	1.68	42.7	.96	24.4
G35510-0505	5C5E-5RMFA	7236-04965	1/4	6.4	1/2-20	9/16	5/8	1.72	43.7	.92	23.4
G35510-0604	6C5E-4RMFA	7236-04975	5/16	7.9	7/16-20	9/16	9/16	2.12	53.9	1.01	25.7
G35510-0606	6C5E-6RMFA	7236-04985	5/16	7.9	9/16-18	5/8	11/16	1.87	47.5	1.03	26.2
G35510-0808	8C5E-8RMFA	7236-04995	13/32	10.3	3/4-16	13/16	7/8	2.15	54.6	1.15	29.2
G35510-1010	10C5E-10RMFA	7236-05005	1/2	12.7	7/8-14	15/16	1	2.34	59.4	1.27	32.3

### Parker Triple Thread Female Swivel - Steel

DOT FMVSS Type A1 (No mandrel required).



Part No.	Descr.	Prod. No.	⊖		🌀	H1	H2	L		C	
			"	mm				"	mm	"	mm
G35562-1616	16C5E-16RFZX	7238-01075	7/8	22.2	1 5/16-14	1 1/2	1 1/2	2.74	69.6	1.68	42.7

- EQUIPMENT
- HOSE/CPLG. SELECTION
- G8K COUPLINGS
- GLOBALSPIRAL COUPLINGS
- STAINLESS STEEL SPIRAL
- MEGACRIMP COUPLINGS
- STAINLESS STEEL BRAID
- POWER CRIMP COUPLINGS
- FIELD ATTACHABLE G1 & G2 COUPLINGS
- FIELD ATTACHABLE C5 COUPLINGS**
- C14 COUPLINGS
- GL COUPLINGS
- GLX COUPLINGS
- PCTS THERMOPLASTIC COUPLINGS
- POLARSEAL COUPLINGS (ACA)
- POLARSEAL II COUPLINGS (ACC)
- POLARSEAL II COUPLINGS (ACB)
- POWER STEERING
- ADAPTERS
- QUICK DISCONNECT COUPLERS
- BALL VALVES
- LIVE SWIVEL
- ASSEMBLY FABRICATION
- ACCESSORIES
- EQUIPMENT AND PARTS
- KITS
- AIR BRAKE HOSE ASSY
- BRASS



**NOTES**

EQUIPMENT
HOSE/CPLG. SELECTION
G8K COUPLINGS
GLOBAL SPIRAL COUPLINGS
STAINLESS STEEL SPIRAL
MEGACRIMP COUPLINGS
STAINLESS STEEL BRAID
POWER CRIMP COUPLINGS
FIELD ATTACHABLE G1 & G2 COUPLINGS
FIELD ATTACHABLE C5 COUPLINGS
C14 COUPLINGS
GL COUPLINGS
GLX COUPLINGS
PCTS THERMOPLASTIC COUPLINGS
POLARSEAL COUPLINGS (ACA)
POLARSEAL II COUPLINGS (ACC)
POLARSEAL II COUPLINGS (ACB)
POWER STEERING
ADAPTERS
QUICK DISCONNECT COUPLERS
BALL VALVES
LIVE SWIVEL
ASSEMBLY FABRICATION
ACCESSORIES
EQUIPMENT AND PARTS
KITS
AIR BRAKE HOSE ASSY
BRASS



# HYDRAULIC HOSE FOR C14 COUPLINGS



EQUIPMENT
HOSE/CPLG. SELECTION
G8K COUPLINGS
GLOBALSPIRAL COUPLINGS
STAINLESS STEEL SPIRAL
MEGACRIMP COUPLINGS
STAINLESS STEEL BRAID
POWER CRIMP COUPLINGS
FIELD ATTACHABLE G1 & G2 COUPLINGS
FIELD ATTACHABLE C5 COUPLINGS
<b>C14 COUPLINGS</b>
GL COUPLINGS
GLX COUPLINGS
PCTS THERMOPLASTIC COUPLINGS
POLARSEAL COUPLINGS (ACA)
POLARSEAL II COUPLINGS (ACC)
POLARSEAL II COUPLINGS (ACB)
POWER STEERING
ADAPTERS
QUICK DISCONNECT COUPLERS
BALL VALVES
LIVE SWIVEL
ASSEMBLY FABRICATION
ACCESSORIES
EQUIPMENT AND PARTS
KITS
AIR BRAKE HOSE ASSY
BRASS

**The Gates eCrimp program** is a web based utility which allows users and distributors of Gates hydraulic and industrial hose products to find and print the most up to date crimp specifications with nothing more than an internet browser.

This program can be used to find crimp data for all Gates crimpers. Custom result may be printed by selecting the crimper, hose and coupling. Optionally results may also be limited by die set and working pressure.

The eCrimp web application can be directly accessed from a web browser by entering <http://eCrimp.Gates.com> for the website.

**The eCrimp mobile app** is available for download for the iPhone and iPad from the App Store.



### Male Pipe (NPTF - 30° Cone Seat) - Stainless Steel

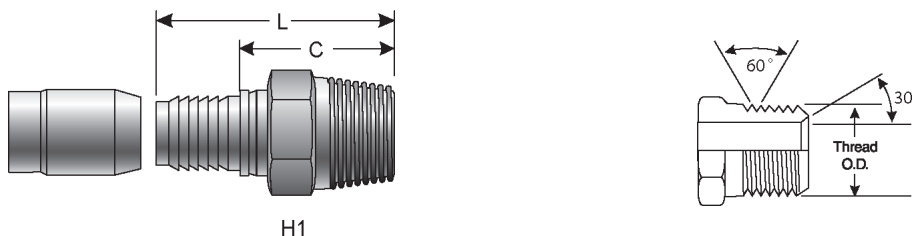

Part No.	Descr.	Prod. No.	⊖		H1	L		C		
			"	mm		"	"	mm	"	mm
G40100-0402S	4C14-2MP-SS	7753-00085	3/16	4.8	1/8-27	7/16	1.26	32.0	.81	20.6
G40100-0404S	4C14-4MP-SS	7753-00015	3/16	4.8	1/4-18	9/16	1.47	37.3	1.02	25.9
G40100-0504S	5C14-4MP-SS	7753-00025	1/4	6.4	1/4-18	9/16	1.47	37.3	1.02	25.9
G40100-0604S	6C14-4MP-SS	7753-00095	5/16	7.9	1/4-18	9/16	1.60	40.7	1.05	26.7
G40100-0606S	6C14-6MP-SS	7753-00035	5/16	7.9	3/8-18	11/16	1.63	41.4	1.08	27.4
G40100-0806S	8C14-6MP-SS	7753-00105	13/32	10.3	3/8-18	11/16	1.68	42.7	1.07	27.2
G40100-0808S	8C14-8MP-SS	7753-00045	13/32	10.3	1/2-14	7/8	1.93	49.0	1.32	33.5
G40100-1008S	10C14-8MP-SS	7753-00055	1/2	12.7	1/2-14	7/8	2.05	52.1	1.35	34.3
G40100-1212S	12C14-12MP-SS	7753-00065	5/8	15.9	3/4-14	1 1/16	2.21	56.1	1.44	36.6
G40100-1616S	16C14-16MP-SS	7753-00075	7/8	22.2	1-11 1/2	1 3/8	2.56	65.0	1.65	41.9

### Male Pipe (NPTF - 30° Cone Seat) - Brass

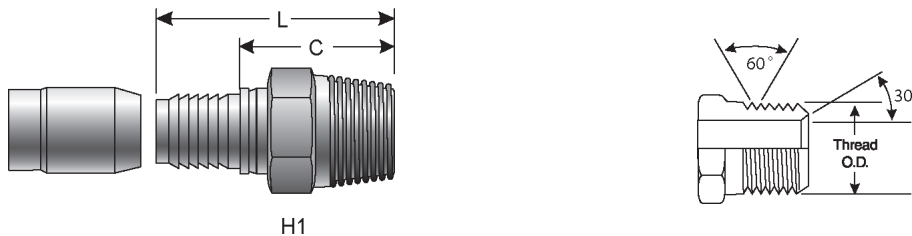

Part No.	Descr.	Prod. No.	⊖		H1	L		C		
			"	mm		"	"	mm	"	mm
△ G40100-0402B	4C14-2MP-B	7753-10085	3/16	4.8	1/8-27	7/16	1.26	32.0	.81	20.6
△ G40100-0404B	4C14-4MP-B	7753-10015	3/16	4.8	1/4-18	9/16	1.47	37.3	1.02	25.9
△ G40100-0504B	5C14-4MP-B	7753-10025	1/4	6.4	1/4-18	9/16	1.47	37.3	1.02	25.9
△ G40100-0604B	6C14-4MP-B	7753-10095	5/16	7.9	1/4-18	9/16	1.60	40.7	1.05	26.7
△ G40100-0606B	6C14-6MP-B	7753-10035	5/16	7.9	3/8-18	11/16	1.63	41.4	1.08	27.4
△ G40100-0806B	8C14-6MP-B	7753-10105	13/32	10.3	3/8-18	11/16	1.68	42.7	1.07	27.2
△ G40100-0808B	8C14-8MP-B	7753-10045	13/32	10.3	1/2-14	7/8	1.93	49.0	1.32	33.5
△ G40100-1008B	10C14-8MP-B	7753-10055	1/2	12.7	1/2-14	7/8	2.05	52.1	1.35	34.3
△ G40100-1212B	12C14-12MP-B	7753-10065	5/8	15.9	3/4-14	1 1/16	2.21	56.1	1.44	36.6
△ G40100-1616B	16C14-16MP-B	7753-10075	7/8	22.2	1-11 1/2	1 3/8	2.56	65.0	1.65	41.9

△ WARNING: Cancer and Reproductive Harm - www.P65Warnings.ca.gov



### Dual Seat Female JIC 37°/SAE 45° Flare Swivel - Stainless Steel

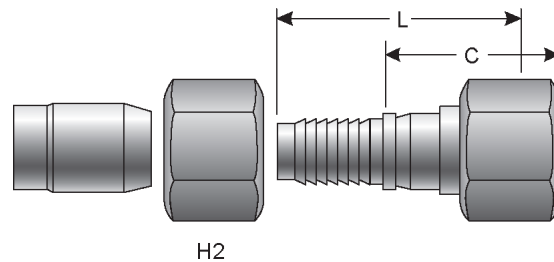

Part No.	Descr.	Prod. No.	⊖		H2	L		C		
			"	mm		"	"	mm	"	mm
G40170-0404S	4C14-4FJSX-SS	7753-00125	3/16	4.8	7/16-20	9/16	.95	24.1	.87	22.1
G40170-0505S	5C14-5FJSX-SS	7753-00135	1/4	6.4	1/2-20	11/16	1.01	25.7	.94	23.9
G40170-0808S	8C14-8FJSX-SS	7753-00155	13/32	10.3	3/4-16	7/8	1.30	33.0	1.13	28.7
G40170-1010S	10C14-10FJSX-SS	7753-00165	1/2	12.7	7/8-14	1 1/16	1.47	37.3	1.29	32.8
G40170-1616S	16C14-16FJSX-SS	7753-00185	7/8	22.2	1 5/16-12	1 1/2	1.75	44.5	1.46	37.1

### Dual Seat Female JIC 37°/SAE 45° Flare Swivel - Brass

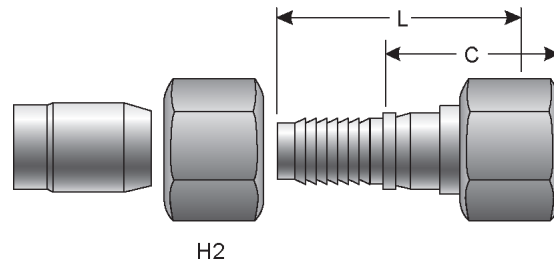

Part No.	Descr.	Prod. No.	⊖		H2	L		C		
			"	mm		"	"	mm	"	mm
△ G40170-0404B	4C14-4FJSX-B	7753-10125	3/16	4.8	7/16-20	9/16	.95	24.1	.79	20.1
△ G40170-0505B	5C14-5FJSX-B	7753-10135	1/4	6.4	1/2-20	11/16	1.01	25.7	.94	23.9
△ G40170-0808B	8C14-8FJSX-B	7753-10155	13/32	10.3	3/4-16	7/8	1.30	33.0	1.13	28.7
△ G40170-1010B	10C14-10FJSX-B	7753-10165	1/2	12.7	7/8-14	1 1/16	1.47	37.3	1.29	32.8
△ G40170-1616B	16C14-16FJSX-B	7753-10185	7/8	22.2	1 5/16-12	1 1/2	1.75	44.5	1.46	37.1

△ WARNING: Cancer and Reproductive Harm - www.P65Warnings.ca.gov

- EQUIPMENT
- HOSE/CPLG. SELECTION
- G8K COUPLINGS
- GLOBALSPIRAL COUPLINGS
- STAINLESS STEEL SPIRAL
- MEGACRIMP COUPLINGS
- STAINLESS STEEL BRAID
- POWER CRIMP COUPLINGS
- FIELD ATTACHABLE G1 & G2 COUPLINGS
- FIELD ATTACHABLE C5 COUPLINGS
- C14 COUPLINGS**
- GL COUPLINGS
- GLX COUPLINGS
- PCTS THERMOPLASTIC COUPLINGS
- POLARSEAL COUPLINGS (ACA)
- POLARSEAL II COUPLINGS (ACC)
- POLARSEAL II COUPLINGS (ACB)
- POWER STEERING
- ADAPTERS
- QUICK DISCONNECT COUPLERS
- BALL VALVES
- LIVE SWIVEL
- ASSEMBLY FABRICATION
- ACCESSORIES
- EQUIPMENT AND PARTS
- KITS
- AIR BRAKE HOSE ASSY
- BRASS





EQUIPMENT
HOSE/CPLG. SELECTION
G8K COUPLINGS
GLOBALSPIRAL COUPLINGS
STAINLESS STEEL SPIRAL
MEGACRIMP COUPLINGS
STAINLESS STEEL BRAID
POWER CRIMP COUPLINGS
FIELD ATTACHABLE G1 & G2 COUPLINGS
FIELD ATTACHABLE C5 COUPLINGS
<b>C14 COUPLINGS</b>
GL COUPLINGS
GLX COUPLINGS
PCTS THERMOPLASTIC COUPLINGS
POLARSEAL COUPLINGS (ACA)
POLARSEAL II COUPLINGS (ACC)
POLARSEAL II COUPLINGS (ACB)
POWER STEERING
ADAPTERS
QUICK DISCONNECT COUPLERS
BALL VALVES
LIVE SWIVEL
ASSEMBLY FABRICATION
ACCESSORIES
EQUIPMENT AND PARTS
KITS
AIR BRAKE HOSE ASSY
BRASS

### Female JIC 37° Flare Swivel - Stainless Steel

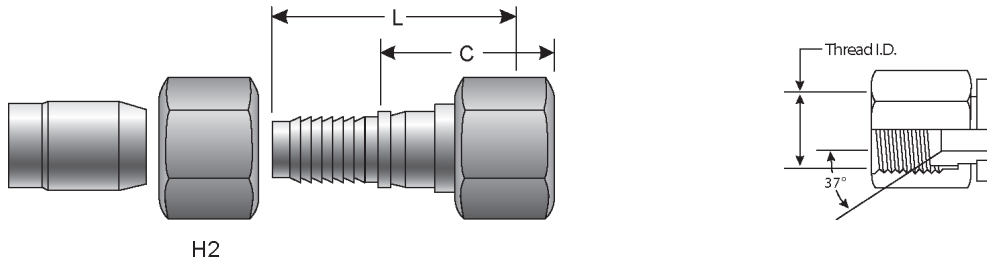

Part No.	Descr.	Prod. No.	⌀		H2	L		C		
			"	mm		"	mm	"	mm	
G40170-0606S	6C14-6FJX-SS	7753-00145	5/16	7.9	9/16-18	3/4	1.19	30.2	1.01	25.7
G40170-1212S	12C14-12FJX-SS	7753-00175	5/8	15.9	1 1/16-12	1 1/4	1.56	39.6	1.36	34.5

### Female JIC 37° Flare Swivel - Brass

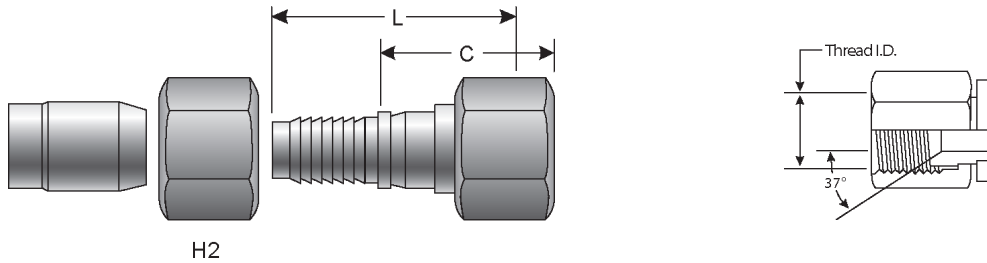

Part No.	Descr.	Prod. No.	⌀		H2	L		C		
			"	mm		"	mm	"	mm	
△ G40170-0606B	6C14-6FJX-B	7753-10145	5/16	7.9	9/16-18	3/4	1.19	30.2	1.01	25.7
△ G40170-1212B	12C14-12FJX-B	7753-10175	5/8	15.9	1 1/16-12	1 1/4	1.56	39.6	1.36	34.5

△ WARNING: Cancer and Reproductive Harm - www.P65Warnings.ca.gov

### Female JIC 37° Flare Swivel - 45° Bent Tube - Steel

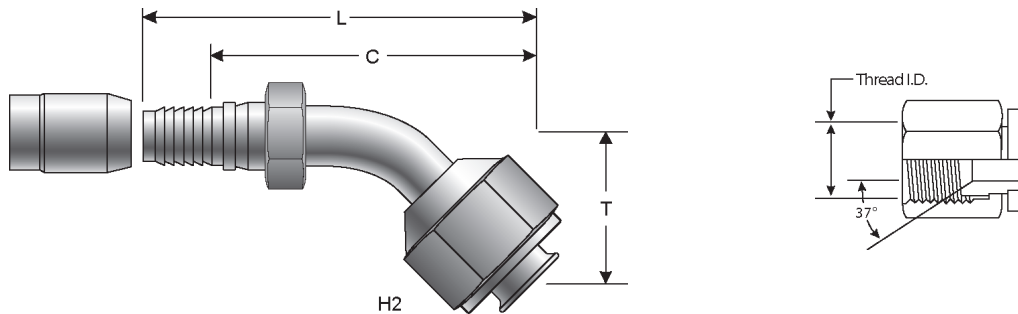

Part No.	Descr.	Prod. No.	⌀		H2	T		L		C		
			"	mm		"	mm	"	mm	"	mm	
G40175-0404	4C14-4FJX45	7753-20495	3/16	4.8	7/16-20	9/16	.41	10.4	1.69	42.9	1.25	31.8



Female JIC 37° Flare Swivel - 45° Bent Tube - Steel - Continued

Part No.	Descr.	Prod. No.	⊖		H2	T		L		C		
			"	mm		"	mm	"	mm	"	mm	
G40175-0505	5C14-5FJX45	7753-20505	1/4	6.4	1/2-20	5/8	.49	12.5	1.85	47.0	1.44	36.6
G40175-0606	6C14-6FJX45	7753-20515	5/16	7.9	9/16-18	11/16	.55	14.0	2.13	54.1	1.62	41.2
G40175-0808	8C14-8FJX45	7753-20525	13/32	10.3	3/4-16	7/8	.63	16.0	2.44	62.0	1.88	47.8
G40175-1010	10C14-10FJX45	7753-20535	1/2	12.7	7/8-14	1	.75	19.1	2.78	70.6	2.08	52.8
G40175-1212	12C14-12FJX45	7753-20545	5/8	15.9	1 1/16-12	1 1/4	.90	22.9	3.92	99.6	3.15	80.0
G40175-1616	16C14-16FJX45	7753-20555	7/8	22.2	1 5/16-12	1 1/2	1.13	28.7	4.77	121.2	3.86	98.0

Female JIC 37° Flare Swivel - 90° Bent Tube - Steel

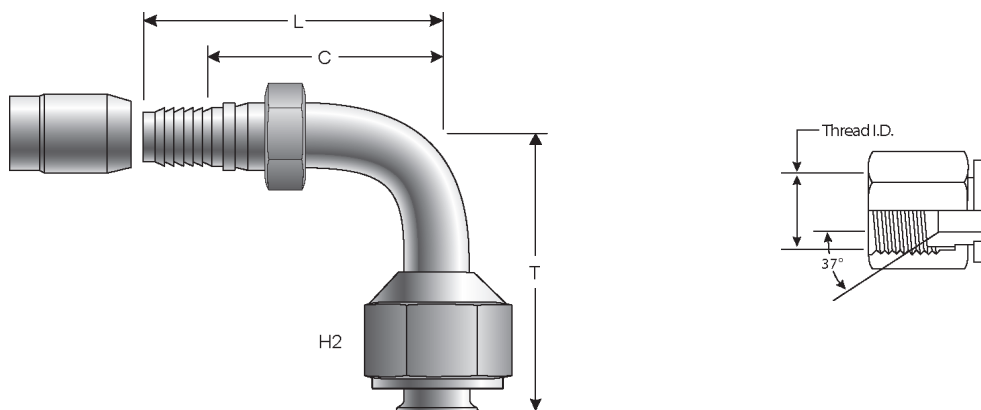

Part No.	Descr.	Prod. No.	⊖		H2	T		L		C		
			"	mm		"	mm	"	mm	"	mm	
G40179-0404	4C14-4FJX90	7753-20565	3/16	4.8	7/16-20	9/16	.71	18.0	1.42	36.1	1.00	25.4
G40179-0505	5C14-5FJX90	7753-20575	1/4	6.4	1/2-20	5/8	.88	22.4	1.55	39.4	1.06	26.9
G40179-0606	6C14-6FJX90	7753-20585	5/16	7.9	9/16-18	11/16	1.00	25.4	1.80	45.7	1.25	31.8
G40179-0808	8C14-8FJX90	7753-20595	13/32	10.3	3/4-16	7/8	1.18	30.0	2.10	53.3	1.50	38.1
G40179-1010	10C14-10FJX90	7753-20605	1/2	12.7	7/8-14	1	1.50	38.1	2.47	62.7	1.81	46.0
G40179-1212	12C14-12FJX90	7753-20615	5/8	15.9	1 1/16-12	1 1/4	2.00	50.8	3.88	98.6	3.11	79.0
G40179-1616	16C14-16FJX90	7753-20625	7/8	22.2	1 5/16-12	1 1/2	2.48	63.0	4.64	117.9	3.73	94.7

- EQUIPMENT
- HOSE/CPLG. SELECTION
- G8K COUPLINGS
- GLOBAL SPIRAL COUPLINGS
- STAINLESS STEEL SPIRAL
- MEGACRIMP COUPLINGS
- STAINLESS STEEL BRAID
- POWER CRIMP COUPLINGS
- FIELD ATTACHABLE G1 & G2 COUPLINGS
- FIELD ATTACHABLE C5 COUPLINGS
- C14 COUPLINGS**
- GL COUPLINGS
- GLX COUPLINGS
- PCTS THERMOPLASTIC COUPLINGS
- POLARSEAL COUPLINGS (ACA)
- POLARSEAL II COUPLINGS (ACC)
- POLARSEAL II COUPLINGS (ACB)
- POWER STEERING
- ADAPTERS
- QUICK DISCONNECT COUPLERS
- BALL VALVES
- LIVE SWIVEL
- ASSEMBLY FABRICATION
- ACCESSORIES
- EQUIPMENT AND PARTS
- KITS
- AIR BRAKE HOSE ASSY
- BRASS



### Female SAE 45° Flare Swivel - Brass

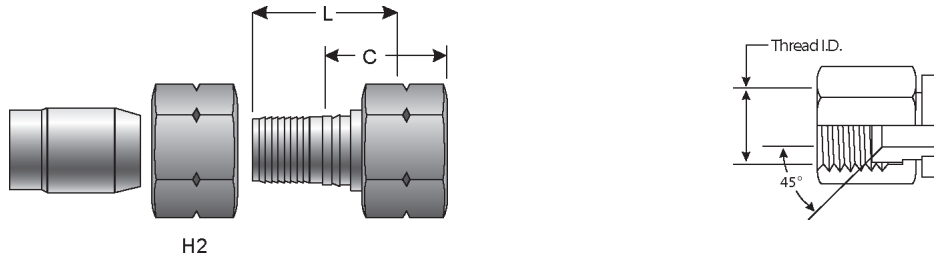

Part No.	Descr.	Prod. No.	⊖		H2	L		C		
			"	mm		"	mm	"	mm	
△ G40200-0606B	6C14-6FSX-B	7753-10195	5/16	7.9	5/8-18	3/4	1.19	30.2	1.01	25.7
△ G40200-1212B	12C14-12FSX-B	7753-10205	5/8	15.9	1 1/16-14	1 1/4	1.56	39.6	1.36	34.5

⚠ WARNING: Cancer and Reproductive Harm - www.P65Warnings.ca.gov

### Female SAE 45° Flare Swivel - 45° Bent Tube - Steel

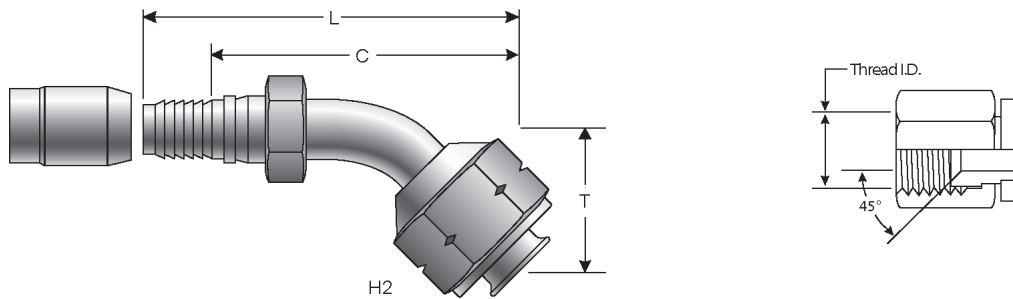

Part No.	Descr.	Prod. No.	⊖		H2	T		L		C		
			"	mm		"	mm	"	mm	"	mm	
G40202-0404	4C14-4FSX45	7753-20215	3/16	4.8	7/16-20	9/16	.41	10.4	1.69	42.9	1.25	31.8
G40202-0505	5C14-5FSX45	7753-20225	1/4	6.4	1/2-20	5/8	.49	12.5	1.85	47.0	1.44	36.6
G40202-0606	6C14-6FSX45	7753-20235	5/16	7.9	5/8-18	3/4	.55	14.0	2.13	54.1	1.62	41.2
G40202-0808	8C14-8FSX45	7753-20245	13/32	10.3	3/4-16	7/8	.63	16.0	2.44	62.0	1.88	47.8
G40202-1010	10C14-10FSX45	7753-20635	1/2	12.7	7/8-14	1	.75	19.1	2.78	70.6	2.12	53.9
G40202-1212	12C14-12FSX45	7753-20645	5/8	15.9	1 1/16-14	1 1/4	.90	22.9	3.92	99.6	3.15	80.0

EQUIPMENT
HOSE/CPLG. SELECTION
G8K COUPLINGS
GLOBALSPIRAL COUPLINGS
STAINLESS STEEL SPIRAL
MEGACRIMP COUPLINGS
STAINLESS STEEL BRAID
POWER CRIMP COUPLINGS
FIELD ATTACHABLE G1 & G2 COUPLINGS
FIELD ATTACHABLE C5 COUPLINGS
<b>C14 COUPLINGS</b>
GL COUPLINGS
GLX COUPLINGS
PCTS THERMOPLASTIC COUPLINGS
POLARSEAL COUPLINGS (ACA)
POLARSEAL II COUPLINGS (ACC)
POLARSEAL II COUPLINGS (ACB)
POWER STEERING
ADAPTERS
QUICK DISCONNECT COUPLERS
BALL VALVES
LIVE SWIVEL
ASSEMBLY FABRICATION
ACCESSORIES
EQUIPMENT AND PARTS
KITS
AIR BRAKE HOSE ASSY
BRASS



### Female SAE 45° Flare Swivel - 90° Bent Tube - Steel

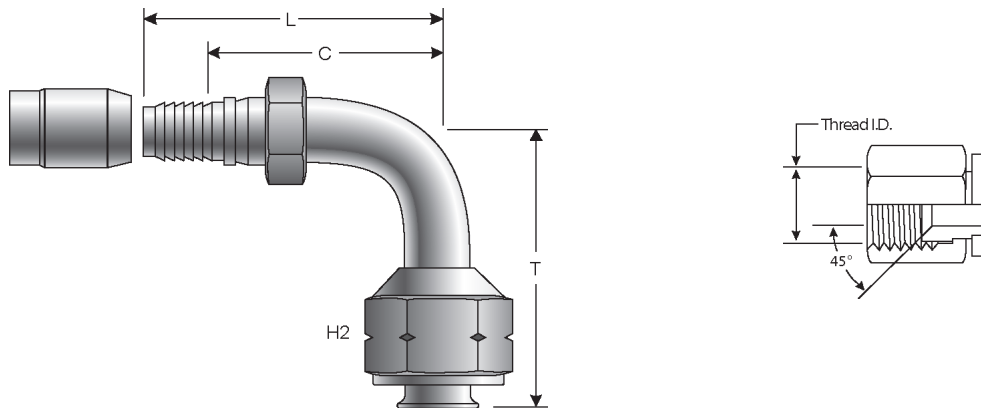

Part No.	Descr.	Prod. No.	⌀		H2	T		L		C		
			"	mm		"	mm	"	mm	"	mm	
G40205-0404	4C14-4FSX90	7753-20255	3/16	4.8	7/16-20	9/16	.71	18.0	1.42	36.1	1.00	25.4
G40205-0505	5C14-5FSX90	7753-20265	1/4	6.4	1/2-20	5/8	.88	22.4	1.55	39.4	1.06	26.9
G40205-0606	6C14-6FSX90	7753-20275	5/16	7.9	5/8-18	3/4	1.00	25.4	1.80	45.7	1.25	31.8
G40205-0808	8C14-8FSX90	7753-20285	13/32	10.3	3/4-16	7/8	1.18	30.0	2.10	53.3	1.50	38.1
G40205-1010	10C14-10FSX90	7753-20295	1/2	12.7	7/8-14	1 1/16	1.50	38.1	2.47	62.7	1.81	46.0
G40205-1212	12C14-12FSX90	7753-20665	5/8	15.9	1 1/16-14	1 1/4	2.00	50.8	3.88	98.6	3.11	79.0

### Air Brake Compression - Brass

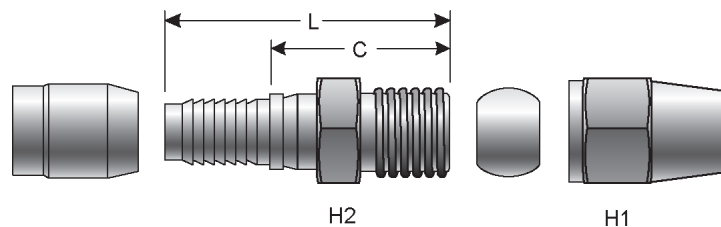

Part No.	Descr.	Prod. No.	⌀		H1	H2	L		C		⌀
			"	mm			"	mm	"	mm	
△ G40460-0808B	8C14-8ABC-B	7753-10365	13/32	10.3	7/8	13/16	1.71	43.4	1.10	27.9	.50
△ G40460-1010B	10C14-10ABC-B	7753-10385	1/2	12.7	7/8	15/16	1.89	48.0	1.19	30.2	.63
△ G40460-1212B	12C14-12ABC-B	7753-10395	5/8	15.9	1-18	1 1/8	2.13	54.1	1.36	34.5	.75

△ WARNING: Cancer and Reproductive Harm - www.P65Warnings.ca.gov

- EQUIPMENT
- HOSE/CPLG. SELECTION
- G8K COUPLINGS
- GLOBALSPIRAL COUPLINGS
- STAINLESS STEEL SPIRAL
- MEGACRIMP COUPLINGS
- STAINLESS STEEL BRAID
- POWER CRIMP COUPLINGS
- FIELD ATTACHABLE G1 & G2 COUPLINGS
- FIELD ATTACHABLE C5 COUPLINGS
- C14 COUPLINGS**
- GL COUPLINGS
- GLX COUPLINGS
- PCTS THERMOPLASTIC COUPLINGS
- POLARSEAL COUPLINGS (ACA)
- POLARSEAL II COUPLINGS (ACC)
- POLARSEAL II COUPLINGS (ACB)
- POWER STEERING
- ADAPTERS
- QUICK DISCONNECT COUPLERS
- BALL VALVES
- LIVE SWIVEL
- ASSEMBLY FABRICATION
- ACCESSORIES
- EQUIPMENT AND PARTS
- KITS
- AIR BRAKE HOSE ASSY
- BRASS



EQUIPMENT
HOSE/CPLG. SELECTION
G8K COUPLINGS
GLOBAL SPIRAL COUPLINGS
STAINLESS STEEL SPIRAL
MEGACRIMP COUPLINGS
STAINLESS STEEL BRAID
POWER CRIMP COUPLINGS
FIELD ATTACHABLE G1 & G2 COUPLINGS
FIELD ATTACHABLE C5 COUPLINGS
<b>C14 COUPLINGS</b>
GL COUPLINGS
GLX COUPLINGS
PCTS THERMOPLASTIC COUPLINGS
POLARSEAL COUPLINGS (ACA)
POLARSEAL II COUPLINGS (ACC)
POLARSEAL II COUPLINGS (ACB)
POWER STEERING
ADAPTERS
QUICK DISCONNECT COUPLERS
BALL VALVES
LIVE SWIVEL
ASSEMBLY FABRICATION
ACCESSORIES
EQUIPMENT AND PARTS
KITS
AIR BRAKE HOSE ASSY
BRASS

### Straight Tube Assembly - Brass

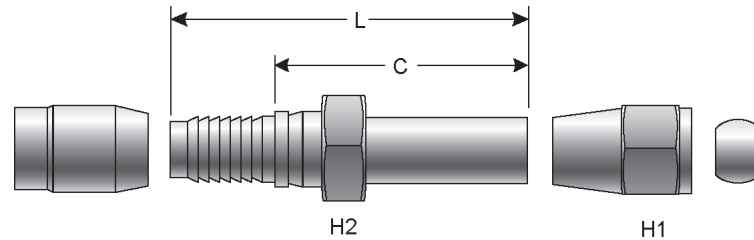

Part No.	Descr.	Prod. No.	⌀		H1	H2	L		C		⌀	
			"	mm			"	mm	"	mm		"
△ G40461-1008B	10C14-8STA-B	7753-10415	1/2	12.7	11/16-20	3/4	13/16	3.18	80.8	2.21	56.1	.50
△ G40461-1010B	10C14-10STA-B	7753-10425	1/2	12.7	13/16-18	3/4	15/16	3.50	88.9	2.53	64.3	.63
△ G40461-1212B	12C14-12STA-B	7753-10435	5/8	15.9	1-18	7/8	1 1/8	3.67	93.2	2.61	66.3	.75

⚠ WARNING: Cancer and Reproductive Harm - www.P65Warnings.ca.gov

### SAE Male Inverted Swivel - Steel

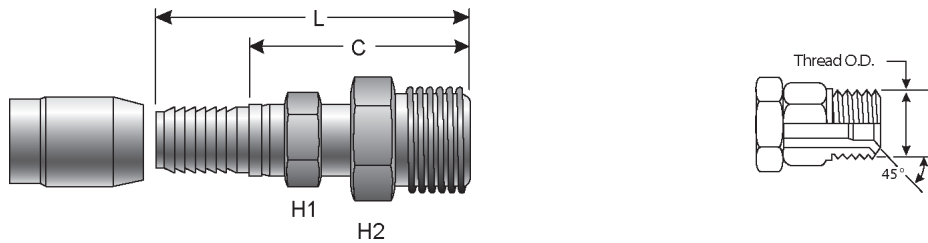

Part No.	Descr.	Prod. No.	⌀		H1	H2	L		C		
			"	mm			"	mm	"	mm	
G40500-0404	4C14-4MIX	7753-20305	3/16	4.8	7/16-24	7/16	7/16	1.84	46.7	1.39	35.3
G40500-0505	5C14-5MIX	7753-20315	1/4	6.4	1/2-20	1/2	1/2	1.90	48.3	1.45	36.8
G40500-0606	6C14-6MIX	7753-20325	5/16	7.9	5/8-18	9/16	5/8	2.07	52.6	1.52	38.6
G40500-0808	8C14-8MIX	7753-20335	13/32	10.3	3/4-18	5/8	3/4	2.21	56.1	1.60	40.6
G40500-1010	10C14-10MIX	7753-20345	1/2	12.7	7/8-18	3/4	7/8	2.47	62.7	1.77	45.0



### SAE Male Inverted Swivel - 45° Bent Tube - Steel

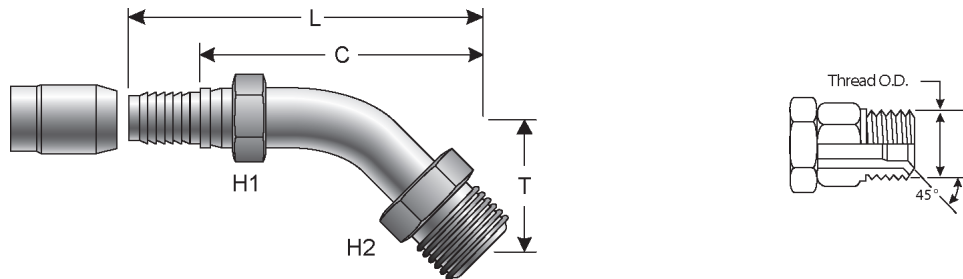

Part No.	Descr.	Prod. No.	⌀		H1	H2	T		L		C		
			"	mm			"	mm	"	mm	"	mm	
G40502-0404	4C14-4MIX45	7753-20355	3/16	4.8	7/16-24	7/16	7/16	.73	18.6	1.99	50.6	1.53	38.9
G40502-0606	6C14-6MIX45	7753-20365	5/16	7.9	5/8-18	9/16	5/8	.94	23.9	2.48	63.0	1.93	49.0
G40502-0808	8C14-8MIX45	7753-20375	13/32	10.3	3/4-18	5/8	3/4	1.14	29.0	2.95	74.9	2.10	53.3
G40502-1010	10C14-10MIX45	7753-20695	1/2	12.7	7/8-18	3/4	7/8	1.34	34.0	3.37	85.6	2.67	67.8
G40502-1212	12C14-12MIX45	7753-20705	5/8	15.9	1 1/16-16	7/8	1 1/16	1.54	39.1	4.56	115.8	3.79	96.3

### SAE Male Inverted Swivel - 90° Bent Tube - Steel

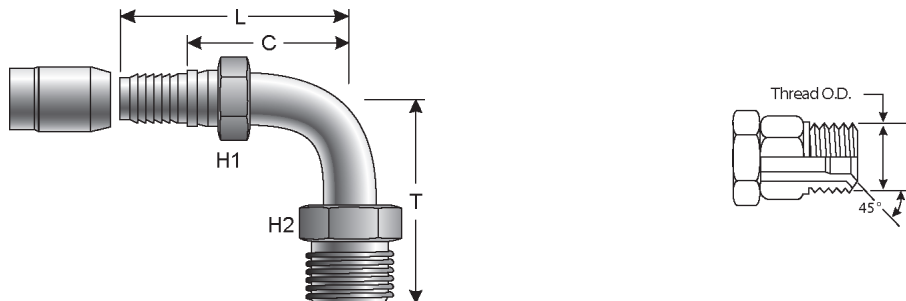

Part No.	Descr.	Prod. No.	⌀		H1	H2	T		L		C		
			"	mm			"	mm	"	mm	"	mm	
G40504-0404	4C14-4MIX90	7753-20385	3/16	4.8	7/16-24	7/16	7/16	1.30	33.0	1.42	36.1	.97	24.6
G40504-0505	5C14-5MIX90	7753-20395	1/4	6.4	1/2-20	1/2	1/2	1.48	37.6	1.54	39.1	1.09	27.7
G40504-0606	6C14-6MIX90	7753-20405	5/16	7.9	5/8-18	9/16	5/8	1.63	41.4	1.80	45.7	1.25	31.8
G40504-0808	8C14-8MIX90	7753-20415	13/32	10.3	3/4-18	5/8	3/4	1.91	48.5	2.10	53.3	1.77	45.0
G40504-1010	10C14-10MIX90	7753-20425	1/2	12.7	7/8-18	3/4	7/8	2.16	54.9	2.47	62.7	1.77	45.0
G40504-1212	12C14-12MIX90	7753-20715	5/8	15.9	1 1/16-16	7/8	1 1/16	2.66	67.6	3.60	91.4	2.83	71.9

EQUIPMENT
HOSE/CPLG. SELECTION
G8K COUPLINGS
GLOBALSPIRAL COUPLINGS
STAINLESS STEEL SPIRAL
MEGACRIMP COUPLINGS
STAINLESS STEEL BRAID
POWER CRIMP COUPLINGS
FIELD ATTACHABLE G1 & G2 COUPLINGS
FIELD ATTACHABLE C5 COUPLINGS
<b>C14 COUPLINGS</b>
GL COUPLINGS
GLX COUPLINGS
PCTS THERMOPLASTIC COUPLINGS
POLARSEAL COUPLINGS (ACA)
POLARSEAL II COUPLINGS (ACC)
POLARSEAL II COUPLINGS (ACB)
POWER STEERING
ADAPTERS
QUICK DISCONNECT COUPLERS
BALL VALVES
LIVE SWIVEL
ASSEMBLY FABRICATION
ACCESSORIES
EQUIPMENT AND PARTS
KITS
AIR BRAKE HOSE ASSY
BRASS



EQUIPMENT
HOSE/CPLG. SELECTION
G8K COUPLINGS
GLOBAL SPIRAL COUPLINGS
STAINLESS STEEL SPIRAL
MEGACRIMP COUPLINGS
STAINLESS STEEL BRAID
POWER CRIMP COUPLINGS
FIELD ATTACHABLE G1 & G2 COUPLINGS
FIELD ATTACHABLE C5 COUPLINGS
<b>C14 COUPLINGS</b>
GL COUPLINGS
GLX COUPLINGS
PCTS THERMOPLASTIC COUPLINGS
POLARSEAL COUPLINGS (ACA)
POLARSEAL II COUPLINGS (ACC)
POLARSEAL II COUPLINGS (ACB)
POWER STEERING
ADAPTERS
QUICK DISCONNECT COUPLERS
BALL VALVES
LIVE SWIVEL
ASSEMBLY FABRICATION
ACCESSORIES
EQUIPMENT AND PARTS
KITS
AIR BRAKE HOSE ASSY
BRASS

## Two-Bolt Flange Swivel - Brass (Steel Flange) - Laundry Flange

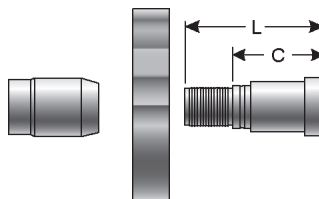

Part No.	Descr.	Prod. No.	⊖		L		C	
			"	mm	"	mm	"	mm
△ G40543-1212	12C14-12TBFLX	7753-10265	5/8	15.9	2.27	57.7	.59	15.0
△ G40543-1616	16C14-16TBFLX	7753-10275	7/8	22.2	2.45	62.2	.81	20.6

⚠ WARNING: Cancer and Reproductive Harm - www.P65Warnings.ca.gov

## C14 Assembly with Two Female Dual Seat JIC 37°/SAE 45° Flare Swivel (FJSX) Couplings-Steel



Part No.	Descr.	Prod. No.	⊖		L	
			"	mm	"	mm
G89170-1018	10C14-10FJSX-10FJSX-18	4479-0002	1/2	12.7	18.00	457.2
G89170-1024	10C14-10FJSX-10FJSX-24	4479-0003	1/2	12.7	24.00	609.6
G89170-1030	10C14-10FJSX-10FJSX-30	4479-0004	1/2	12.7	30.00	762.0
G89170-1036	10C14-10FJSX-10FJSX-36	4479-0005	1/2	12.7	36.00	914.4
G89170-1042	10C14-10FJSX-10FJSX-42	4479-0006	1/2	12.7	42.00	1066.8
G89170-1048	10C14-10FJSX-10FJSX-48	4479-0007	1/2	12.7	48.00	1219.2
G89170-1054	10C14-10FJSX-10FJSX-54	4479-0008	1/2	12.7	54.00	1371.6
G89170-1072	10C14-10FJSX-10FJSX-72	4479-0009	1/2	12.7	72.00	1828.8
G89170-1084	10C14-10FJSX-10FJSX-84	4479-0010	1/2	12.7	84.00	2133.6

## C14 Assembly with Two Air Brake Compression (ABC) Couplings - Steel



Part No.	Descr.	Prod. No.	⊖		L	
			"	mm	"	mm
G89460-1018	10C14-10ABC-10ABC-18	4479-0011	1/2	12.7	18.00	457.2
G89460-1024	10C14-10ABC-10ABC-24	4479-0012	1/2	12.7	24.00	609.6





### C14 Assembly with Two Straight Tube Assembly (STA) Couplings - Steel



Part No.	Descr.	Prod. No.	⊖		L	
			"	mm	"	mm
G89461-1024	10C14-10STA-10STA-24	4479-0014	1/2	12.7	24.00	609.6
G89461-1036	10C14-10STA-10STA-36	4479-0015	1/2	12.7	36.00	914.4
G89461-1224	12C14-12STA-12STA-24	4479-0020	5/8	15.9	24.00	609.6

### C14 One Straight Tube Assembly (STA) and One Air Brake Compression (ABC) Couplings - Steel



Part No.	Descr.	Prod. No.	⊖		L	
			"	mm	"	mm
G89462-1018	10C14-10STA-10ABC-18	4479-0016	1/2	12.7	18.00	457.2
G89462-1024	10C14-10STA-10ABC-24	4479-0017	1/2	12.7	24.00	609.6
G89462-1036	10C14-10STA-10ABC-36	4479-0018	1/2	12.7	36.00	914.4
G89462-1048	10C14-10STA-10ABC-48	4479-0019	1/2	12.7	48.00	1219.2

- EQUIPMENT
- HOSE/CPLG. SELECTION
- G8K COUPLINGS
- GLOBALSPIRAL COUPLINGS
- STAINLESS STEEL SPIRAL
- MEGACRIMP COUPLINGS
- STAINLESS STEEL BRAID
- POWER CRIMP COUPLINGS
- FIELD ATTACHABLE G1 & G2 COUPLINGS
- FIELD ATTACHABLE C5 COUPLINGS
- C14 COUPLINGS**
- GL COUPLINGS
- GLX COUPLINGS
- PCTS THERMOPLASTIC COUPLINGS
- POLARSEAL COUPLINGS (ACA)
- POLARSEAL II COUPLINGS (ACC)
- POLARSEAL II COUPLINGS (ACB)
- POWER STEERING
- ADAPTERS
- QUICK DISCONNECT COUPLERS
- BALL VALVES
- LIVE SWIVEL
- ASSEMBLY FABRICATION
- ACCESSORIES
- EQUIPMENT AND PARTS
- KITS
- AIR BRAKE HOSE ASSY
- BRASS



**NOTES**

EQUIPMENT
HOSE/CPLG. SELECTION
G8K COUPLINGS
GLOBAL SPIRAL COUPLINGS
STAINLESS STEEL SPIRAL
MEGACRIMP COUPLINGS
STAINLESS STEEL BRAID
POWER CRIMP COUPLINGS
FIELD ATTACHABLE G1 & G2 COUPLINGS
FIELD ATTACHABLE C5 COUPLINGS
<b>C14 COUPLINGS</b>
GL COUPLINGS
GLX COUPLINGS
PCTS THERMOPLASTIC COUPLINGS
POLARSEAL COUPLINGS (ACA)
POLARSEAL II COUPLINGS (ACC)
POLARSEAL II COUPLINGS (ACB)
POWER STEERING
ADAPTERS
QUICK DISCONNECT COUPLERS
BALL VALVES
LIVE SWIVEL
ASSEMBLY FABRICATION
ACCESSORIES
EQUIPMENT AND PARTS
KITS
AIR BRAKE HOSE ASSY
BRASS



# HYDRAULIC HOSE FOR GL COUPLINGS



**The Gates eCrimp program** is a web based utility which allows users and distributors of Gates hydraulic and industrial hose products to find and print the most up to date crimp specifications with nothing more than an internet browser.

This program can be used to find crimp data for all Gates crimpers. Custom result may be printed by selecting the crimper, hose and coupling. Optionally results may also be limited by die set and working pressure.

The eCrimp web application can be directly accessed from a web browser by entering <http://eCrimp.Gates.com> for the website.

**The eCrimp mobile app** is available for download for the iPhone and iPad from the App Store.

EQUIPMENT
HOSE/CPLG. SELECTION
G8K COUPLINGS
GLOBALSPIRAL COUPLINGS
STAINLESS STEEL SPIRAL
MEGACRIMP COUPLINGS
STAINLESS STEEL BRAID
POWER CRIMP COUPLINGS
FIELD ATTACHABLE G1 & G2 COUPLINGS
FIELD ATTACHABLE C5 COUPLINGS
C14 COUPLINGS
<b>GL COUPLINGS</b>
GLX COUPLINGS
PCTS THERMOPLASTIC COUPLINGS
POLARSEAL COUPLINGS (ACA)
POLARSEAL II COUPLINGS (ACC)
POLARSEAL II COUPLINGS (ACB)
POWER STEERING
ADAPTERS
QUICK DISCONNECT COUPLERS
BALL VALVES
LIVE SWIVEL
ASSEMBLY FABRICATION
ACCESSORIES
EQUIPMENT AND PARTS
KITS
AIR BRAKE HOSE ASSY
BRASS



EQUIPMENT
HOSE/CPLG. SELECTION
G8K COUPLINGS
GLOBALSPIRAL COUPLINGS
STAINLESS STEEL SPIRAL
MEGACRIMP COUPLINGS
STAINLESS STEEL BRAID
POWER CRIMP COUPLINGS
FIELD ATTACHABLE G1 & G2 COUPLINGS
FIELD ATTACHABLE C5 COUPLINGS
C14 COUPLINGS
<b>GL COUPLINGS</b>
GLX COUPLINGS
PCTS THERMOPLASTIC COUPLINGS
POLARSEAL COUPLINGS (ACA)
POLARSEAL II COUPLINGS (ACC)
POLARSEAL II COUPLINGS (ACB)
POWER STEERING
ADAPTERS
QUICK DISCONNECT COUPLERS
BALL VALVES
LIVE SWIVEL
ASSEMBLY FABRICATION
ACCESSORIES
EQUIPMENT AND PARTS
KITS
AIR BRAKE HOSE ASSY
BRASS

### Male Pipe (NPTF - 30° Cone Seat)

Special GL Dies Required.

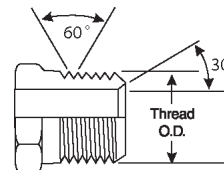
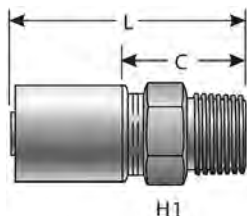

Part No.	Descr.	Prod. No.	⊖		H1	L		C		
			"	mm		"	mm	"	mm	
G43100-1212	12GL-12MP	7348-00015	3/4	19.1	3/4-14	1 3/4	3.46	87.9	1.46	37.1
G43100-1216	12GL-16MP	7348-00025	3/4	19.1	1-11 1/2	1 3/8	1.77	45.0	1.64	41.7
G43100-1616	16GL-16MP	7348-00035	1	25.4	1-11 1/2	1 3/8	4.11	104.4	1.88	47.8
G43100-2020	20GL-20MP	7348-00045	1 1/4	31.8	1 1/4-11 1/2	1 3/4	2.13	54.1	2.09	53.1
G43100-2424	24GL-24MP	7348-00055	1 1/2	38.1	1 1/2-11 1/2	2	4.83	122.7	2.19	55.6
G43100-3232	32GL-32MP	7348-00065	2	50.8	2-11 1/2	2 1/2	5.39	136.9	2.33	59.2

### Male Pipe Swivel (NPTF - without 30° Cone Seat)

NOT TO BE USED AS A LIVE SWIVEL.  
Special GL Dies Required.

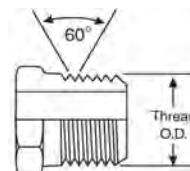
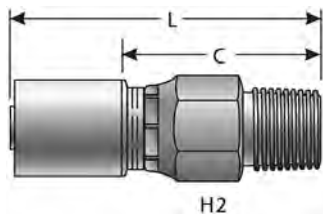

Part No.	Descr.	Prod. No.	⊖		H2	L		C		
			"	mm		"	mm	"	mm	
G43105-1616	16GL-16MPX	7348-00115	1	25.4	1-11 1/2	1 5/8	4.73	120.1	2.50	63.5

### Female JIC 37° Flare Swivel

Special GL Dies Required.

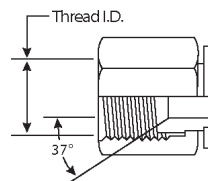
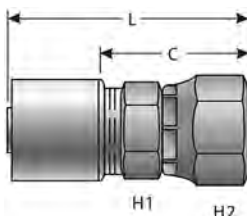

Part No.	Descr.	Prod. No.	⊖		H1	H2	L		C		
			"	mm			"	mm	"	mm	
G43170-1212	12GL-12FJX	7348-00205	3/4	19.1	1 1/16-12	1 1/16	1 1/4	3.68	93.5	1.67	42.4



### Female JIC 37° Flare Swivel - Continued

Part No.	Descr.	Prod. No.	⊖		🌀	H1	H2	L		C	
			"	mm				"	mm	"	mm
G43170-1214	12GL-14FJX	7348-00215	3/4	19.1	1 3/16-12	1 1/8	1 3/8	3.65	92.7	1.64	41.7
G43170-1216	12GL-16FJX	7348-00225	3/4	19.1	1 5/16-12	1 1/4	1 1/2	3.78	96.0	1.77	45.0
G43170-1616	16GL-16FJX	7348-00235	1	25.4	1 5/16-12	1 3/8	1 1/2	4.17	105.9	1.94	49.3
G43170-2020	20GL-20FJX	7348-00245	1 1/4	31.8	1 5/8-12	1 3/4	2	4.58	116.3	2.26	57.4
G43170-2420	24GL-20FJX	7348-00195	1 1/2	38.1	1 5/8-12	1 3/4	2	4.84	122.9	2.20	55.9
G43170-2424	24GL-24FJX	7348-00255	1 1/2	38.1	1 7/8-12	2	2 1/4	5.19	131.8	2.55	64.8
G43170-3232	32GL-32FJX	7348-00265	2	50.8	2 1/2-12	2 1/2	2 7/8	5.98	151.9	2.92	74.2
G43170-4040	40GL-40FJX	7305-05475	2 1/2	63.5	3-12	3	3 1/2	5.36	136.1	2.91	73.9

### Female JIC 37° Flare Swivel - 45° Bent Tube

Special GL Dies Required.

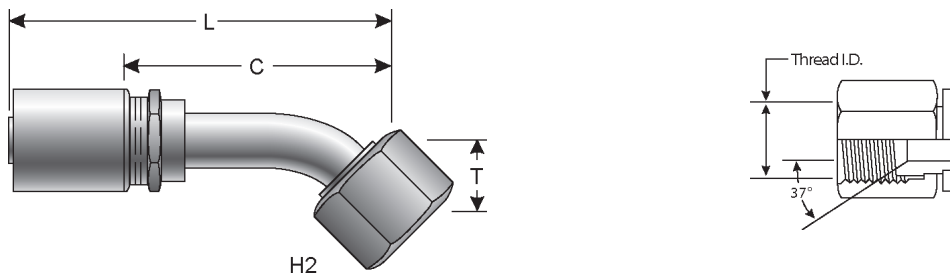

Part No.	Descr.	Prod. No.	⊖		🌀	H2	T		L		C	
			"	mm			"	mm	"	mm	"	mm
G43174-1212	12GL-12FJX45S-021	7348-01265	3/4	19.1	1 1/16-12	1 1/4	.83	21.1	4.76	120.9	2.76	70.1

### Female JIC 37° Flare Swivel - 90° Bent Tube

Special GL Dies Required.

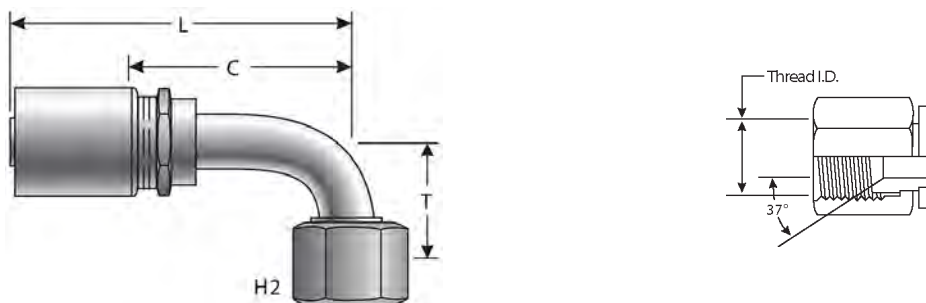

Part No.	Descr.	Prod. No.	⊖		🌀	H2	T		L		C	
			"	mm			"	mm	"	mm	"	mm
G43179-1212	12GL-12FJX90S	7348-01385	3/4	19.1	1 1/16-12	1 1/4	1.89	48.0	4.61	117.1	2.60	66.0
G43179-1616	16GL-16FJX90S	7348-01485	1	25.4	1 5/16-12	1 1/2	2.20	55.9	5.12	130.1	2.88	73.2
G43180-2020	20GL-20FJX90M	7348-01525	1 1/4	31.8	1 5/8-12	2	3.07	78.0	6.24	158.5	3.91	99.3
G43180-2420	24GL-20FJX90M	7348-01585	1 1/2	38.1	1 5/8-12	2	3.07	78.0	6.24	158.5	3.91	99.3
G43181-2420	24GL-20FJX90L	7348-01595	1 1/2	38.1	1 5/8-12	2	5.08	129.0	5.59	142.0	2.96	75.2

- EQUIPMENT
- HOSE/CPLG. SELECTION
- G8K COUPLINGS
- GLOBAL SPIRAL COUPLINGS
- STAINLESS STEEL SPIRAL
- MEGACRIMP COUPLINGS
- STAINLESS STEEL BRAID
- POWER CRIMP COUPLINGS
- FIELD ATTACHABLE G1 & G2 COUPLINGS
- FIELD ATTACHABLE C5 COUPLINGS
- C14 COUPLINGS
- GL COUPLINGS**
- GLX COUPLINGS
- PCTS THERMOPLASTIC COUPLINGS
- POLARSEAL COUPLINGS (ACA)
- POLARSEAL II COUPLINGS (ACC)
- POLARSEAL II COUPLINGS (ACB)
- POWER STEERING
- ADAPTERS
- QUICK DISCONNECT COUPLERS
- BALL VALVES
- LIVE SWIVEL
- ASSEMBLY FABRICATION
- ACCESSORIES
- EQUIPMENT AND PARTS
- KITS
- AIR BRAKE HOSE ASSY
- BRASS



EQUIPMENT
HOSE/CPLG. SELECTION
G8K COUPLINGS
GLOBAL SPIRAL COUPLINGS
STAINLESS STEEL SPIRAL
MEGACRIMP COUPLINGS
STAINLESS STEEL BRAID
POWER CRIMP COUPLINGS
FIELD ATTACHABLE G1 & G2 COUPLINGS
FIELD ATTACHABLE C5 COUPLINGS
C14 COUPLINGS
<b>GL COUPLINGS</b>
GLX COUPLINGS
PCTS THERMOPLASTIC COUPLINGS
POLARSEAL COUPLINGS (ACA)
POLARSEAL II COUPLINGS (ACC)
POLARSEAL II COUPLINGS (ACB)
POWER STEERING
ADAPTERS
QUICK DISCONNECT COUPLERS
BALL VALVES
LIVE SWIVEL
ASSEMBLY FABRICATION
ACCESSORIES
EQUIPMENT AND PARTS
KITS
AIR BRAKE HOSE ASSY
BRASS

### Female JIC 37° Flare Swivel - 90° Bent Tube - Continued

Part No.	Descr.	Prod. No.	⊖		H2	T		L		C		
			"	mm		"	mm	"	mm	"	mm	
G43183-2424	24GL-24FJX90-092	7348-01545	1 1/2	38.1	1 7/8-12	2 1/4	4.05	102.9	7.10	180.3	4.85	123.2

### Female Flat-Face Swivel

SAE J1453 O-Ring Face Seal.  
Special GL Dies Required.

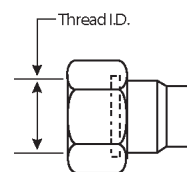
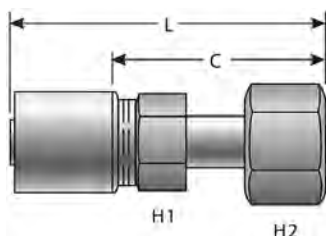

Part No.	Descr.	Prod. No.	⊖		H1	H2	L		C		
			"	mm			"	mm	"	mm	
G43230-1212	12GL-12FFORX	7348-00305	3/4	19.1	1 3/16-12	1 1/16	1 3/8	3.78	96.0	1.77	45.0
G43230-1616	16GL-16FFORX	7348-00355	1	25.4	1 7/16-12	1 3/8	1 5/8	4.46	113.3	2.22	56.4
G43230-2020	20GL-20FFORX	7348-00365	1 1/4	31.8	1 11/16-12	1 3/4	1 7/8	4.50	114.3	2.18	55.4
G43230-2424	24GL-24FFORX	7348-00375	1 1/2	38.1	2-12	1 3/8	2 1/4	3.98	101.1	1.74	44.2

### Female Flat-Face Swivel - 45° Bent Tube

SAE J1453 O-Ring Face Seal.  
Special GL Dies Required.

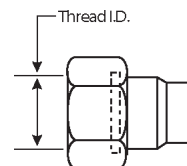
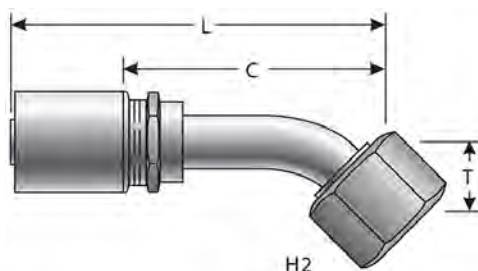

Part No.	Descr.	Prod. No.	⊖		H2	T		L		C		
			"	mm		"	mm	"	mm	"	mm	
G43234-1212	12GL-12FFORX45S	7348-00405	3/4	19.1	1 3/16-12	1 3/8	.83	21.1	4.67	118.6	2.66	67.6
G43234-1616	16GL-16FFORX45S	7348-00415	1	25.4	1 7/16-12	1 5/8	.94	23.9	5.08	129.0	2.85	72.4
G43234-2020	20GL-20FFORX45S	7348-00425	1 1/4	31.8	1 11/16-12	1 7/8	.98	24.9	5.81	147.6	3.49	88.7



## Female Flat-Face Swivel - 90° Bent Tube

SAE J1453 O-Ring Face Seal.  
Special GL Dies Required.

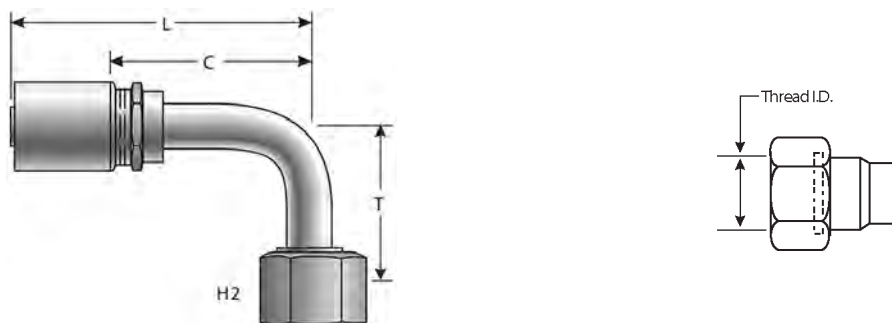

Part No.	Descr.	Prod. No.	⊖		H2	T		L		C		
			"	mm		"	mm	"	mm	"	mm	
G43239-1212	12GL-12FFORX90S	7348-00455	3/4	19.1	1 3/16-12	1 3/8	1.89	48.0	4.28	108.7	2.28	57.9
G43240-1212	12GL-12FFORX90M	7348-02155	3/4	19.1	1 3/16-12	1 1/4	1.89	48.0	4.61	117.1	2.60	66.0
G43239-1616	16GL-16FFORX90S	7348-00465	1	25.4	1 7/16-12	1 5/8	2.20	55.9	5.11	129.8	2.88	73.2
G43239-2020	20GL-20FFORX90S	7348-00475	1 1/4	31.8	1 11/16-12	1 7/8	2.52	64.0	5.51	140.0	3.19	81.0
G43240-2424	24GL-24FFORX90M	7350-24985	1 1/2	38.1	2-12	2 1/3	3.39	86.1	7.26	184.4	4.62	117.4

## Code 61 O-Ring Flange

Special GL Dies Required.

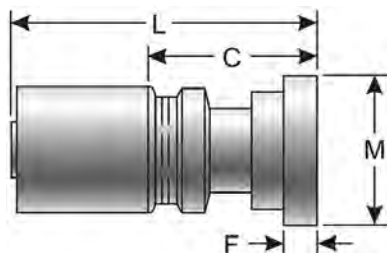

Part No.	Descr.	Prod. No.	⊖		M		L		C		F	
			"	mm	"	mm	"	mm	"	mm	"	mm
G43300-1212	12GL-12FL	7348-00505	3/4	19.1	1.50	38.1	3.86	98.1	1.85	47.0	.27	6.9
G43300-1616	16GL-16FL	7348-00555	1	25.4	1.75	44.5	3.78	96.0	1.54	39.1	.32	8.1
G43300-2020	20GL-20FL	7348-00525	1 1/4	31.8	2.00	50.8	4.43	112.5	2.11	53.6	.32	8.1
G43300-2424	24GL-24FL	7348-00535	1 1/2	38.1	2.38	60.5	4.94	125.5	2.30	58.4	.32	8.1
G43300-3232	32GL-32FL	7348-00545	2	50.8	2.81	71.4	5.61	142.5	2.54	64.5	.38	9.7
G43300-3240	32GL-40FL	7350-25575	2	50.8	3.31	84.1	5.61	142.5	2.55	64.7	.38	9.7
G43300-4040	40GL-40FL	7305-05505	2 1/2	63.5	3.31	84.1	5.66	143.8	3.15	80.0	.38	9.7
G43300-4048	40GL-48FL	7305-05605	2 1/2	63.5	4.00	101.6	5.66	143.8	3.21	81.5	.38	9.7
G43300-4056	40GL-56FL	7305-05705	2 1/2	63.5	4.50	114.3	5.33	135.4	2.77	70.4	.44	11.2
G43300-4064	40GL-64FL	7305-05795	2 1/2	63.5	5.00	127.0	5.33	135.4	2.88	73.2	.44	11.2
G43300-4848	48GL-48FL	7305-05805	3	76.2	4.00	101.6	6.54	166.1	3.46	87.9	.38	9.7
G43300-5656	56GL-56FL	7305-06305	3 1/2	88.9	4.50	114.3	6.70	170.2	3.06	77.7	.44	11.2
G43300-6464	64GL-64FL	7305-06695	4	101.6	5.00	127.0	7.74	196.6	3.70	94.0	.44	11.2

EQUIPMENT
HOSE/CPLG. SELECTION
G8K COUPLINGS
GLOBALSPIRAL COUPLINGS
STAINLESS STEEL SPIRAL
MEGACRIMP COUPLINGS
STAINLESS STEEL BRAID
POWER CRIMP COUPLINGS
FIELD ATTACHABLE G1 & G2 COUPLINGS
FIELD ATTACHABLE C5 COUPLINGS
C14 COUPLINGS
<b>GL COUPLINGS</b>
GLX COUPLINGS
PCTS THERMOPLASTIC COUPLINGS
POLARSEAL COUPLINGS (ACA)
POLARSEAL II COUPLINGS (ACC)
POLARSEAL II COUPLINGS (ACB)
POWER STEERING
ADAPTERS
QUICK DISCONNECT COUPLERS
BALL VALVES
LIVE SWIVEL
ASSEMBLY FABRICATION
ACCESSORIES
EQUIPMENT AND PARTS
KITS
AIR BRAKE HOSE ASSY
BRASS





EQUIPMENT
HOSE/CPLG. SELECTION
G8K COUPLINGS
GLOBAL SPIRAL COUPLINGS
STAINLESS STEEL SPIRAL
MEGACRIMP COUPLINGS
STAINLESS STEEL BRAID
POWER CRIMP COUPLINGS
FIELD ATTACHABLE G1 & G2 COUPLINGS
FIELD ATTACHABLE C5 COUPLINGS
C14 COUPLINGS
<b>GL COUPLINGS</b>
GLX COUPLINGS
PCTS THERMOPLASTIC COUPLINGS
POLARSEAL COUPLINGS (ACA)
POLARSEAL II COUPLINGS (ACC)
POLARSEAL II COUPLINGS (ACB)
POWER STEERING
ADAPTERS
QUICK DISCONNECT COUPLERS
BALL VALVES
LIVE SWIVEL
ASSEMBLY FABRICATION
ACCESSORIES
EQUIPMENT AND PARTS
KITS
AIR BRAKE HOSE ASSY
BRASS

### Code 61 O-Ring Flange - 22° Bent Tube

Special GL Dies Required.

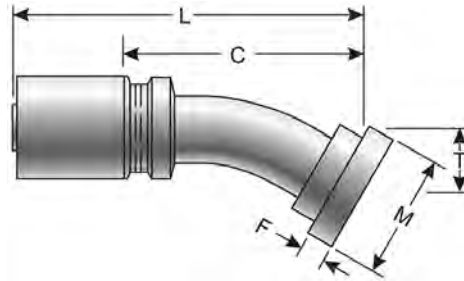

Part No.	Descr.	Prod. No.	⊖		M		T		L		C		F	
			"	mm	"	mm	"	mm	"	mm	"	mm	"	mm
G43302-2424	24GL-24FL22M-018	7348-00575	1 1/2	38.1	2.38	60.5	.71	18.0	6.39	162.3	3.76	95.5	.32	8.1
G43302-4040	40GL-40FL22	7305-05515	2 1/2	63.5	3.31	84.1	.63	16.0	6.81	173.0	4.36	110.7	.38	9.7
G43302-4048	40GL-48FL22	7305-05615	2 1/2	63.5	4.00	101.6	.67	17.0	6.86	174.2	4.41	112.0	.38	9.7

### Code 61 O-Ring Flange - 30° Bent Tube

Special GL Dies Required.

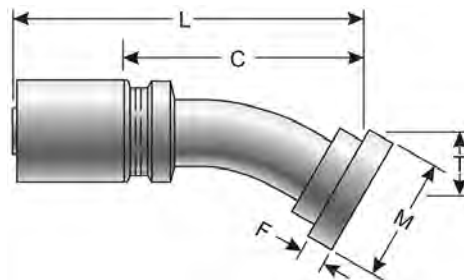

Part No.	Descr.	Prod. No.	⊖		M		T		L		C		F	
			"	mm	"	mm	"	mm	"	mm	"	mm	"	mm
G43304-1212	12GL-12FL30M	7348-00605	3/4	19.1	1.50	38.1	.63	16.0	4.51	114.6	2.50	63.5	.27	6.9
G43304-1616	16GL-16FL30M	7348-00615	1	25.4	1.75	44.5	.75	19.1	4.92	125.0	2.69	68.3	.32	8.1
G43304-2020	20GL-20FL30M	7348-00625	1 1/4	31.8	2.00	50.8	.87	22.1	5.37	136.4	3.05	77.5	.32	8.1
G43304-2424	24GL-24FL30M	7348-00635	1 1/2	38.1	2.38	60.5	1.18	30.0	6.86	174.2	4.22	107.2	.32	8.1
G43304-3232	32GL-32FL30M	7348-00645	2	50.8	2.81	71.4	1.26	32.0	7.78	197.6	4.72	119.9	.38	9.7
G43304-4040	40GL-40FL30	7305-05525	2 1/2	63.5	3.31	84.1	1.08	27.4	7.30	185.4	4.85	123.2	.38	9.7
G43304-4048	40GL-48FL30	7305-05625	2 1/2	63.5	4.00	101.6	1.08	27.4	7.36	186.9	4.91	124.7	.38	9.7
G43304-4848	48GL-48FL30	7305-05825	3	76.2	4.00	101.6	1.12	28.5	8.23	209.0	5.15	130.8	.38	9.7



### Code 61 O-Ring Flange - 45° Bent Tube

Special GL Dies Required.

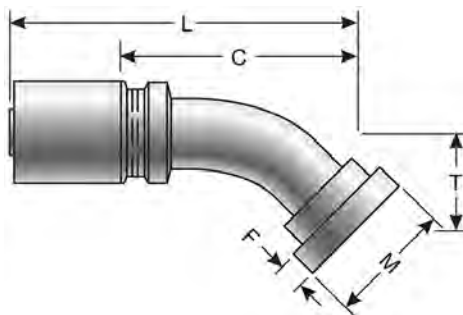

Part No.	Descr.	Prod. No.	⊖		M		T		L		C		F	
			"	mm	"	mm	"	mm	"	mm	"	mm	"	mm
G43307-1212	12GL-12FL45M	7348-00705	3/4	19.1	1.50	38.1	1.02	25.9	4.67	118.6	2.66	67.6	.27	6.9
G43306-1616	16GL-16FL45S	7348-00715	1	25.4	1.75	44.5	1.10	27.9	5.11	129.8	2.87	72.9	.32	8.1
G43306-2020	20GL-20FL45S	7348-00725	1 1/4	31.8	2.00	50.8	1.26	32.0	5.59	142.0	3.29	83.6	.32	8.1
G43306-2424	24GL-24FL45S	7348-00735	1 1/2	38.1	2.38	60.5	1.50	38.1	6.62	168.2	3.99	101.4	.32	8.1
G43306-3232	32GL-32FL45S	7348-00745	2	50.8	2.81	71.4	2.05	52.1	8.07	205.0	5.00	127.0	.38	9.7
G43306-3240	32GL-40FL45S	7348-00785	2	50.8	3.31	84.1	2.05	52.1	9.18	233.2	6.11	155.2	.38	9.7
G43307-4040	40GL-40FL45	7305-05535	2 1/2	63.5	3.31	84.1	1.72	43.7	7.72	196.1	5.27	133.9	.38	9.7
G43307-4048	40GL-48FL45	7305-05635	2 1/2	63.5	4.00	101.6	1.76	44.7	7.76	197.1	5.31	134.9	.38	9.7
G43307-4848	48GL-48FL45	7305-05835	3	76.2	4.00	101.6	2.03	51.6	9.18	233.2	6.10	154.9	.38	9.7
G43307-5656	56GL-56FL45	7305-06335	3 1/2	88.9	4.50	114.3	2.13	54.1	9.66	245.4	6.02	152.9	.44	11.2
G43307-5664	56GL-64FL45	7305-06385	3 1/2	88.9	5.00	127.0	2.13	54.1	9.66	245.4	6.02	152.9	.44	11.2
G43307-6565	64GL-64FL45	7305-06725	4	101.6	5.00	127.0	3.61	91.7	12.70	322.6	8.66	220.0	.38	9.7

### Code 61 O-Ring Flange - 60° Bent Tube

Special GL Dies Required.

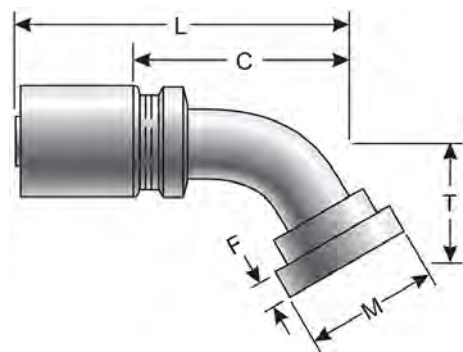

Part No.	Descr.	Prod. No.	⊖		M		T		L		C		F	
			"	mm	"	mm	"	mm	"	mm	"	mm	"	mm
G43309-1212	12GL-12FL60M	7348-00805	3/4	19.1	1.50	38.1	1.46	37.1	4.61	117.1	2.60	66.0	.27	6.9
G43309-1616	16GL-16FL60M	7348-00815	1	25.4	1.75	44.5	1.73	43.9	5.14	130.7	2.90	73.7	.32	8.1
G43308-2020	20GL-20FL60S	7348-00825	1 1/4	31.8	2.00	50.8	1.77	45.0	5.67	144.0	3.35	85.1	.32	8.1
G43308-2424	24GL-24FL60S	7348-00835	1 1/2	38.1	2.38	60.5	2.09	53.1	6.63	168.4	3.99	101.4	.32	8.1
G43309-3232	32GL-32FL60S	7348-00845	2	50.8	2.81	71.4	2.95	74.9	8.59	218.2	5.52	140.2	.38	9.7
G43309-4040	40GL-40FL60	7305-05545	2 1/2	63.5	3.31	84.1	2.63	66.8	8.13	206.5	5.68	144.3	.38	9.7
G43309-4848	48GL-48FL60	7305-05845	3	76.2	4.00	101.6	3.11	79.0	9.66	245.4	6.58	167.1	.38	9.7

EQUIPMENT
HOSE/CPLG. SELECTION
G8K COUPLINGS
GLOBALSPIRAL COUPLINGS
STAINLESS STEEL SPIRAL
MEGACRIMP COUPLINGS
STAINLESS STEEL BRAID
POWER CRIMP COUPLINGS
FIELD ATTACHABLE G1 & G2 COUPLINGS
FIELD ATTACHABLE C5 COUPLINGS
C14 COUPLINGS
<b>GL COUPLINGS</b>
GLX COUPLINGS
PCTS THERMOPLASTIC COUPLINGS
POLARSEAL COUPLINGS (ACA)
POLARSEAL II COUPLINGS (ACC)
POLARSEAL II COUPLINGS (ACB)
POWER STEERING
ADAPTERS
QUICK DISCONNECT COUPLERS
BALL VALVES
LIVE SWIVEL
ASSEMBLY FABRICATION
ACCESSORIES
EQUIPMENT AND PARTS
KITS
AIR BRAKE HOSE ASSY
BRASS



EQUIPMENT
HOSE/CPLG. SELECTION
G8K COUPLINGS
GLOBALSPIRAL COUPLINGS
STAINLESS STEEL SPIRAL
MEGACRIMP COUPLINGS
STAINLESS STEEL BRAID
POWER CRIMP COUPLINGS
FIELD ATTACHABLE G1 & G2 COUPLINGS
FIELD ATTACHABLE C5 COUPLINGS
C14 COUPLINGS
<b>GL COUPLINGS</b>
GLX COUPLINGS
PCTS THERMOPLASTIC COUPLINGS
POLARSEAL COUPLINGS (ACA)
POLARSEAL II COUPLINGS (ACC)
POLARSEAL II COUPLINGS (ACB)
POWER STEERING
ADAPTERS
QUICK DISCONNECT COUPLERS
BALL VALVES
LIVE SWIVEL
ASSEMBLY FABRICATION
ACCESSORIES
EQUIPMENT AND PARTS
KITS
AIR BRAKE HOSE ASSY
BRASS

### Code 61 O-Ring Flange - 67 1/2° Bent Tube

Special GL Dies Required.

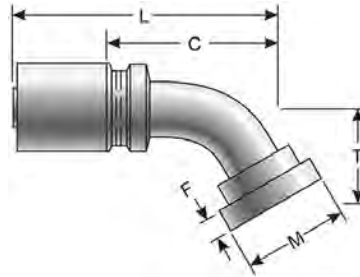

Part No.	Descr.	Prod. No.	⊖		M		T		L		C		F	
			"	mm	"	mm	"	mm	"	mm	"	mm	"	mm
G43311-3232	32GL-32FL67S	7348-00875	2	50.8	2.81	71.4	3.35	85.1	8.56	217.4	5.49	139.5	.38	9.7
G43311-4040	40GL-40FL67	7305-05555	2 1/2	63.5	3.31	84.1	3.13	79.5	8.22	208.8	5.77	146.6	.38	9.7
G43311-4848	48GL-48FL67	7305-05905	3	76.2	4.00	101.6	3.87	98.3	9.50	241.3	6.42	163.1	.38	9.7
G43311-6464	64GL-64FL67	7305-06635	4	101.6	5.00	127.0	6.90	175.3	14.20	360.7	10.17	258.3	.44	11.2

### Code 61 O-Ring Flange - 90° Bent Tube

Special GL Dies Required.

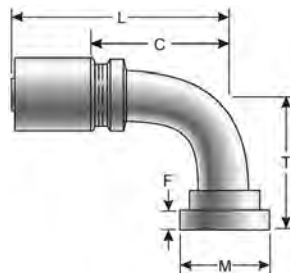

Part No.	Descr.	Prod. No.	⊖		M		T		L		C		F	
			"	mm	"	mm	"	mm	"	mm	"	mm	"	mm
G43315-1212	12GL-12FL90M	7348-00905	3/4	19.1	1.50	38.1	2.28	57.9	4.40	111.8	2.39	60.7	.27	6.9
G43314-1216	12GL-16FL90S	7348-00915	3/4	19.1	1.75	44.5	2.40	61.0	4.40	111.8	2.39	60.7	.32	8.1
G43314-1616	16GL-16FL90S	7348-00925	1	25.4	1.75	44.5	2.40	61.0	5.04	128.0	2.81	71.4	.32	8.1
G43314-1620	16GL-20FL90S	7348-00935	1	25.4	2.00	50.8	2.68	68.1	5.04	128.0	2.81	71.4	.32	8.1
G43314-2020	20GL-20FL90S	7348-00945	1 1/4	31.8	2.00	50.8	2.68	68.1	5.41	137.4	3.09	78.5	.32	8.1
G43314-2024	20GL-24FL90-068	7348-00955	1 1/4	31.8	2.38	60.5	2.68	68.1	5.41	137.4	3.09	78.5	.32	8.1
G43314-2424	24GL-24FL90S	7348-00965	1 1/2	38.1	2.38	60.5	3.12	79.3	6.26	159.0	3.62	92.0	.32	8.1
G43314-3232	32GL-32FL90S	7348-00975	2	50.8	2.81	71.4	4.50	114.3	8.73	221.7	5.20	132.1	.38	9.7
G43314-3240	32GL-40FL90-114	7348-00775	2	50.8	3.31	84.1	4.50	114.3	8.77	222.8	5.71	145.0	.38	9.7
G43315-4040	40GL-40FL90	7305-05565	2 1/2	63.5	3.31	84.1	4.62	117.4	8.06	204.7	5.61	142.5	.38	9.7
G43315-4048	40GL-48FL90	7305-05665	2 1/2	63.5	4.00	101.6	4.62	117.4	8.12	206.3	5.67	144.0	.38	9.7
G43315-4848	48GL-48FL90	7305-05855	3	76.2	4.00	101.6	5.50	139.7	9.70	246.4	6.62	168.2	.38	9.7
G43315-5656	56GL-56FL90	7305-06365	3 1/2	88.9	4.50	114.3	5.63	143.0	10.17	258.3	6.53	165.9	.44	11.2
G43315-5664	56GL-64FL90	7305-06395	3 1/2	88.9	5.00	127.0	6.90	175.3	10.09	256.3	6.45	163.8	.44	11.2
G43315-6464	64GL-64FL90	7305-06645	4	101.6	5.00	127.0	7.38	187.5	12.61	320.3	8.58	217.9	.44	11.2



### Code 61 Captive O-Ring Flange

Special GL Dies Required.

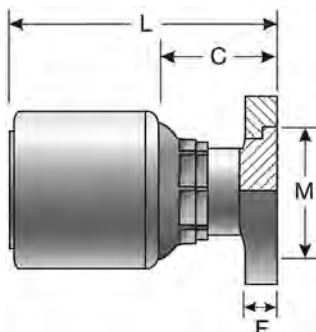

Part No.	Descr.	Prod. No.	⌀		M		L		C		F	
			"	mm	"	mm	"	mm	"	mm	"	mm
	56GL-56FLCF	7348-02705	3 1/2	88.9	4.50	114.3	6.70	170.2	3.06	77.7	.42	.5
G43333-6464	64GL-64FLCF	7348-02755	4	101.6	5.00	127.0	7.74	196.6	3.70	94.0	.44	5.0

### Code 61 Captive O-Ring Flange - 45° Bent Tube

Special GL Dies Required.

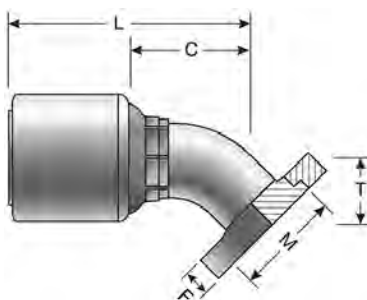

Part No.	Descr.	Prod. No.	⌀		M		T		L		C		F	
			"	mm	"	mm	"	mm	"	mm	"	mm	"	mm
G43334-5656	56GL-56FLCF45-054	7348-02715	3 1/2	88.9	4.50	114.3	2.13	54.1	9.67	245.6	6.02	152.9	.42	4.5

- EQUIPMENT
- HOSE/CPLG. SELECTION
- G8K COUPLINGS
- GLOBALSPIRAL COUPLINGS
- STAINLESS STEEL SPIRAL
- MEGACRIMP COUPLINGS
- STAINLESS STEEL BRAID
- POWER CRIMP COUPLINGS
- FIELD ATTACHABLE G1 & G2 COUPLINGS
- FIELD ATTACHABLE C5 COUPLINGS
- C14 COUPLINGS
- GL COUPLINGS**
- GLX COUPLINGS
- PCTS THERMOPLASTIC COUPLINGS
- POLARSEAL COUPLINGS (ACA)
- POLARSEAL II COUPLINGS (ACC)
- POLARSEAL II COUPLINGS (ACB)
- POWER STEERING
- ADAPTERS
- QUICK DISCONNECT COUPLERS
- BALL VALVES
- LIVE SWIVEL
- ASSEMBLY FABRICATION
- ACCESSORIES
- EQUIPMENT AND PARTS
- KITS
- AIR BRAKE HOSE ASSY
- BRASS



## Code 61 Captive O-Ring Flange - 90° Bent Tube

Special GL Dies Required.

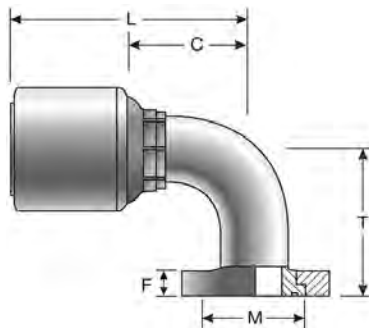

Part No.	Descr.	Prod. No.	⌀		M		T		L		C		F	
			"	mm	"	mm	"	mm	"	mm	"	mm	"	mm
G43335-5656	56GL-56FLCF90-143	7348-02725	3 1/2	88.9	4.50	114.3	5.64	143.3	10.20	258.3	6.53	165.9	.42	4.5

EQUIPMENT
HOSE/CPLG. SELECTION
G8K COUPLINGS
GLOBAL SPIRAL COUPLINGS
STAINLESS STEEL SPIRAL
MEGACRIMP COUPLINGS
STAINLESS STEEL BRAID
POWER CRIMP COUPLINGS
FIELD ATTACHABLE G1 & G2 COUPLINGS
FIELD ATTACHABLE C5 COUPLINGS
C14 COUPLINGS
<b>GL COUPLINGS</b>
GLX COUPLINGS
PCTS THERMOPLASTIC COUPLINGS
POLARSEAL COUPLINGS (ACA)
POLARSEAL II COUPLINGS (ACC)
POLARSEAL II COUPLINGS (ACB)
POWER STEERING
ADAPTERS
QUICK DISCONNECT COUPLERS
BALL VALVES
LIVE SWIVEL
ASSEMBLY FABRICATION
ACCESSORIES
EQUIPMENT AND PARTS
KITS
AIR BRAKE HOSE ASSY
BRASS



# HYDRAULIC HOSE FOR GLX COUPLINGS



EQUIPMENT
HOSE/CPLG. SELECTION
G8K COUPLINGS
GLOBALSPIRAL COUPLINGS
STAINLESS STEEL SPIRAL
MEGACRIMP COUPLINGS
STAINLESS STEEL BRAID
POWER CRIMP COUPLINGS
FIELD ATTACHABLE G1 & G2 COUPLINGS
FIELD ATTACHABLE C5 COUPLINGS
C14 COUPLINGS
GL COUPLINGS
<b>GLX COUPLINGS</b>
PCTS THERMOPLASTIC COUPLINGS
POLARSEAL COUPLINGS (ACA)
POLARSEAL II COUPLINGS (ACC)
POLARSEAL II COUPLINGS (ACB)
POWER STEERING
ADAPTERS
QUICK DISCONNECT COUPLERS
BALL VALVES
LIVE SWIVEL
ASSEMBLY FABRICATION
ACCESSORIES
EQUIPMENT AND PARTS
KITS
AIR BRAKE HOSE ASSY
BRASS

EQUIPMENT
HOSE/CPLG. SELECTION
G8K COUPLINGS
GLOBAL SPIRAL COUPLINGS
STAINLESS STEEL SPIRAL
MEGACRIMP COUPLINGS
STAINLESS STEEL BRAID
POWER CRIMP COUPLINGS
FIELD ATTACHABLE G1 & G2 COUPLINGS
FIELD ATTACHABLE C5 COUPLINGS
C14 COUPLINGS
GL COUPLINGS
GLX COUPLINGS
PCTS THERMOPLASTIC COUPLINGS
POLARSEAL COUPLINGS (ACA)
POLARSEAL II COUPLINGS (ACC)
POLARSEAL II COUPLINGS (ACB)
POWER STEERING
ADAPTERS
QUICK DISCONNECT COUPLERS
BALL VALVES
LIVE SWIVEL
ASSEMBLY FABRICATION
ACCESSORIES
EQUIPMENT AND PARTS
KITS
AIR BRAKE HOSE ASSY
BRASS

### Male Pipe (NPTF 30° Cone Seat)

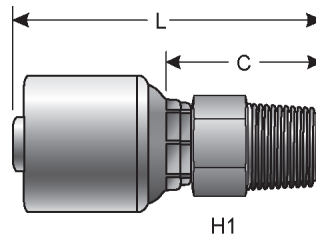

Part No.	Descr.	Prod. No.	Ø		H1	L		C		
			"	mm		"	"	mm	"	mm
G44100-0402	4GLX-2MP	7107-00105	1/4	6.4	1/8-27	1/2	2.01	51.1	.98	24.9
G44100-0404	4GLX-4MP	7107-00115	1/4	6.4	1/4-18	9/16	2.17	55.1	1.14	29.0
G44100-0604	6GLX-4MP	7107-00135	3/8	9.5	1/4-18	11/16	2.32	58.9	1.22	31.0
G44100-0606	6GLX-6MP	7107-00145	3/8	9.5	3/8-18	11/16	2.32	58.9	1.22	31.0
G44100-0806	8GLX-6MP	7107-00165	1/2	12.7	3/8-18	13/16	2.72	69.1	1.24	31.5
G44100-0808	8GLX-8MP	7107-00175	1/2	12.7	1/2-14	7/8	2.78	70.6	1.40	35.6
G44100-0812	8GLX-12MP	7107-00785	1/2	12.7	3/4-14	13/16	3.46	87.9	1.45	36.8
G44100-1008	10GLX-8MP	7107-00195	5/8	15.9	1/2-14	15/16	2.40	61.0	1.55	39.4
G44100-1208	12GLX-8MP	7107-00215	3/4	19.1	1/2-14	1 1/16	3.46	87.9	1.46	37.1
G44100-1212	12GLX-12MP	7107-00225	3/4	19.1	3/4-14	1 1/16	3.46	87.9	1.46	37.1
G44100-1616	16GLX-16MP	7107-00255	1	25.4	1-11 1/2	1 3/8	4.11	104.4	1.88	47.8
G44100-2020	20GLX-20MP	7107-00265	1 1/4	31.8	1 1/4-11 1/2	1 3/4	4.41	112.0	2.09	53.1

### MPX Male NPTF Swivel

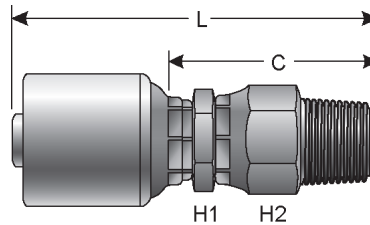

Part No.	Descr.	Prod. No.	Ø		H1	H2	L		C		
			"	mm			"	"	mm	"	mm
G44105-0404	4GLX-4MPX	7107-00565	1/4	6.4	1/4-18	1/2	11/16	2.61	66.3	1.58	40.1
G44105-0606	6GLX-6MPX	7107-00575	3/8	9.5	3/8-18	5/8	7/8	2.81	71.4	1.72	43.7
G44105-0808	8GLX-8MPX	7107-00585	1/2	12.7	1/2-14	13/16	1	3.42	86.9	1.95	49.5
G44105-1212	12GLX-12MPX	7107-00595	3/4	19.1	3/4-14	1 1/16	1 5/16	4.02	102.1	2.01	51.1
G44105-1616	16GLX-16MPX	7107-00605	1	25.4	1-11 1/2	1 3/8	1 5/8	4.73	120.1	2.50	63.5
G44105-2020	20GLX-20MPX	7107-00615	1 1/4	31.8	1 1/4-11 1/2	1 7/8	2	5.30	134.6	2.98	75.7





### FP Female NPTF

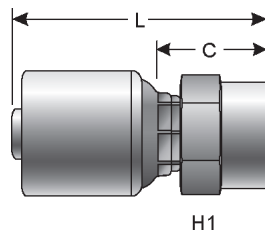

H1

Part No.	Descr.	Prod. No.	⊖			H1	L		C	
			"	mm	"	"	"	mm	"	mm
G44110-0404	4GLX-4FP	7107-00415	1/4	6.4	1/4-18	11/16	1.99	50.6	.96	24.4
G44110-0604	6GLX-4FP	7107-00425	3/8	9.5	1/4-18	11/16	2.07	52.6	.97	24.6
G44110-0606	6GLX-6FP	7107-00435	3/8	9.5	3/8-18	13/16	2.07	52.6	.97	24.6
G44110-0806	8GLX-6FP	7107-00445	1/2	12.7	3/8-18	13/16	2.48	63.0	1.00	25.4
G44110-0808	8GLX-8FP	7107-00455	1/2	12.7	1/2-14	1	2.64	67.1	1.16	29.5
G44110-1212	12GLX-12FP	7107-00465	3/4	19.1	3/4-14	1 1/4	3.23	82.0	1.22	31.0
G44110-1616	16GLX-16FP	7107-00475	1	25.4	1-11 1/2	1 1/2	3.86	98.1	1.62	41.2

### FPX Female NPSM Swivel

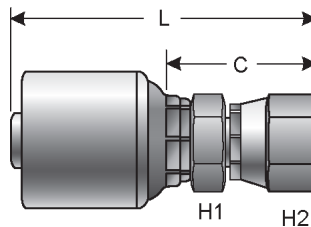

H1

H2

Part No.	Descr.	Prod. No.	⊖			H1	H2	L		C	
			"	mm	"	"	"	"	"	mm	"
G44111-0404	4GLX-4FPX	7107-00345	1/4	6.4	1/4-18	1/2	11/16	2.24	56.9	1.22	31.0
G44111-0604	6GLX-4FPX	7107-00355	3/8	9.5	1/4-18	5/8	11/16	2.40	61.0	1.30	33.0
G44111-0606	6GLX-6FPX	7107-00365	3/8	9.5	3/8-18	5/8	7/8	2.49	63.3	1.39	35.3
G44111-0806	8GLX-6FPX	7107-00375	1/2	12.7	3/8-18	13/16	7/8	2.85	72.4	1.38	35.1
G44111-0808	8GLX-8FPX	7107-00385	1/2	12.7	1/2-14	13/16	1	2.89	73.4	1.41	35.8
G44111-1212	12GLX-12FPX	7107-00395	3/4	19.1	3/4-14	1 1/16	1 1/4	3.72	94.5	1.71	43.4
G44111-1616	16GLX-16FPX	7107-00405	1	25.4	1-11 1/2	1 3/8	1 1/2	4.11	104.4	1.87	47.5

EQUIPMENT
HOSE/CPLG. SELECTION
G8K COUPLINGS
GLOBALSPIRAL COUPLINGS
STAINLESS STEEL SPIRAL
MEGACRIMP COUPLINGS
STAINLESS STEEL BRAID
POWER CRIMP COUPLINGS
FIELD ATTACHABLE G1 & G2 COUPLINGS
FIELD ATTACHABLE C5 COUPLINGS
C14 COUPLINGS
GL COUPLINGS
GLX COUPLINGS
PCTS THERMOPLASTIC COUPLINGS
POLARSEAL COUPLINGS (ACA)
POLARSEAL II COUPLINGS (ACC)
POLARSEAL II COUPLINGS (ACB)
POWER STEERING
ADAPTERS
QUICK DISCONNECT COUPLERS
BALL VALVES
LIVE SWIVEL
ASSEMBLY FABRICATION
ACCESSORIES
EQUIPMENT AND PARTS
KITS
AIR BRAKE HOSE ASSY
BRASS

EQUIPMENT
HOSE/CPLG. SELECTION
G8K COUPLINGS
GLOBAL SPIRAL COUPLINGS
STAINLESS STEEL SPIRAL
MEGACRIMP COUPLINGS
STAINLESS STEEL BRAID
POWER CRIMP COUPLINGS
FIELD ATTACHABLE G1 & G2 COUPLINGS
FIELD ATTACHABLE C5 COUPLINGS
C14 COUPLINGS
GL COUPLINGS
GLX COUPLINGS
PCTS THERMOPLASTIC COUPLINGS
POLARSEAL COUPLINGS (ACA)
POLARSEAL II COUPLINGS (ACC)
POLARSEAL II COUPLINGS (ACB)
POWER STEERING
ADAPTERS
QUICK DISCONNECT COUPLERS
BALL VALVES
LIVE SWIVEL
ASSEMBLY FABRICATION
ACCESSORIES
EQUIPMENT AND PARTS
KITS
AIR BRAKE HOSE ASSY
BRASS

### Female JIC 37° Flare Swivel

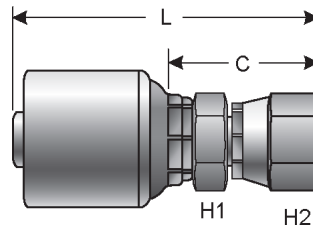

Part No.	Descr.	Prod. No.	⊖		H1	H2	L		C		
			"	mm			"	"	"	mm	"
G44170-0404	4GLX-4FJX	7107-00275	1/4	6.4	7/16-20	1/2	9/16	2.10	53.3	1.08	27.4
G44170-0606	6GLX-6FJX	7107-00285	3/8	9.5	9/16-18	5/8	3/4	2.31	58.7	1.19	30.2
G44170-0808	8GLX-8FJX	7107-00295	1/2	12.7	3/4-16	13/16	7/8	2.82	71.6	1.34	34.0
G44170-1010	10GLX-10FJX	7107-00305	5/8	15.9	7/8-14	—	1 1/16	2.27	57.7	1.42	36.1
G44170-1212	12GLX-12FJX	7107-00315	3/4	19.1	1 1/16-12	1 1/16	1 1/4	3.68	93.5	1.67	42.4
G44170-1616	16GLX-16FJX	7107-00325	1	25.4	1 5/16-12	1 3/8	1 1/2	4.17	105.9	1.94	49.3
G44170-2020	20GLX-20FJX	7107-00335	1 1/4	31.8	1 5/8-12	1 3/4	2	4.58	116.3	2.26	57.4

### MS 45° SAE Male Solid

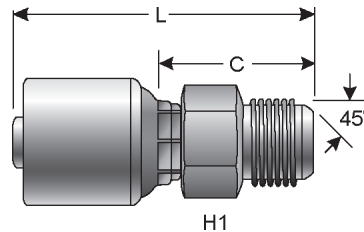

Part No.	Descr.	Prod. No.	⊖		H1	L		C		
			"	mm		"	"	"	mm	"
G44195-0404	4GLX-4MS	7107-00525	1/4	6.4	7/16-20	1/2	2.11	53.6	1.08	27.4
G44195-0606	6GLX-6MS	7107-00535	3/8	9.5	5/8-18	5/8	2.38	60.5	1.28	32.5
G44195-0808	8GLX-8MS	7107-00545	1/2	12.7	3/4-16	13/16	2.89	73.4	1.42	36.1
G44195-1212	12GLX-12MS	7107-00555	3/4	19.1	1 1/16-14	1 1/16	3.78	96.0	1.77	45.0



### FSX 45° SAE Female Swivel

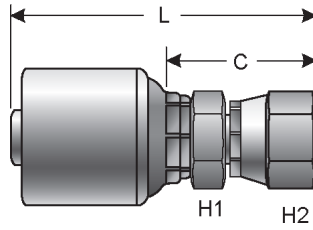

Part No.	Descr.	Prod. No.	⊖		🌀	H1	H2	L		C	
			"	mm				"	"	"	mm
G44200-0404	4GLX-4FSX	7107-00485	1/4	6.4	7/16-20	1/2	9/16	2.24	56.9	1.22	31.0
G44200-0606	6GLX-6FSX	7107-00495	3/8	9.5	5/8-18	5/8	3/4	2.44	62.0	1.35	34.3
G44200-0808	8GLX-8FSX	7107-00505	1/2	12.7	3/4-16	13/16	7/8	2.82	71.6	1.34	34.0
G44200-1212	12GLX-12FSX	7107-00515	3/4	19.1	1 1/16-14	1 1/16	1 1/4	3.68	93.5	1.67	42.4

- EQUIPMENT
- HOSE/CPLG. SELECTION
- G8K COUPLINGS
- GLOBALSPIRAL COUPLINGS
- STAINLESS STEEL SPIRAL
- MEGACRIMP COUPLINGS
- STAINLESS STEEL BRAID
- POWER CRIMP COUPLINGS
- FIELD ATTACHABLE G1 & G2 COUPLINGS
- FIELD ATTACHABLE C5 COUPLINGS
- C14 COUPLINGS
- GL COUPLINGS
- GLX COUPLINGS**
- PCTS THERMOPLASTIC COUPLINGS
- POLARSEAL COUPLINGS (ACA)
- POLARSEAL II COUPLINGS (ACC)
- POLARSEAL II COUPLINGS (ACB)
- POWER STEERING
- ADAPTERS
- QUICK DISCONNECT COUPLERS
- BALL VALVES
- LIVE SWIVEL
- ASSEMBLY FABRICATION
- ACCESSORIES
- EQUIPMENT AND PARTS
- KITS
- AIR BRAKE HOSE ASSY
- BRASS



**NOTES**

EQUIPMENT
HOSE/CPLG. SELECTION
G8K COUPLINGS
GLOBAL SPIRAL COUPLINGS
STAINLESS STEEL SPIRAL
MEGACRIMP COUPLINGS
STAINLESS STEEL BRAID
POWER CRIMP COUPLINGS
FIELD ATTACHABLE G1 & G2 COUPLINGS
FIELD ATTACHABLE C5 COUPLINGS
C14 COUPLINGS
GL COUPLINGS
<b>GLX COUPLINGS</b>
PCTS THERMOPLASTIC COUPLINGS
POLARSEAL COUPLINGS (ACA)
POLARSEAL II COUPLINGS (ACC)
POLARSEAL II COUPLINGS (ACB)
POWER STEERING
ADAPTERS
QUICK DISCONNECT COUPLERS
BALL VALVES
LIVE SWIVEL
ASSEMBLY FABRICATION
ACCESSORIES
EQUIPMENT AND PARTS
KITS
AIR BRAKE HOSE ASSY
BRASS



# HYDRAULIC HOSE FOR PCTS THERMOPLASTIC COUPLINGS

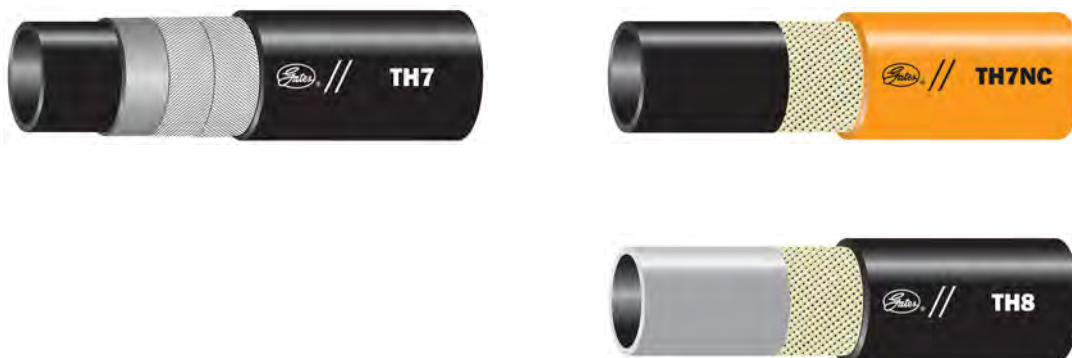

EQUIPMENT
HOSE/CPLG. SELECTION
G8K COUPLINGS
GLOBALSPIRAL COUPLINGS
STAINLESS STEEL SPIRAL
MEGACRIMP COUPLINGS
STAINLESS STEEL BRAID
POWER CRIMP COUPLINGS
FIELD ATTACHABLE G1 & G2 COUPLINGS
FIELD ATTACHABLE C5 COUPLINGS
C14 COUPLINGS
GL COUPLINGS
GLX COUPLINGS
<b>PCTS THERMOPLASTIC COUPLINGS</b>
POLARSEAL COUPLINGS (ACA)
POLARSEAL II COUPLINGS (ACC)
POLARSEAL II COUPLINGS (ACB)
POWER STEERING
ADAPTERS
QUICK DISCONNECT COUPLERS
BALL VALVES
LIVE SWIVEL
ASSEMBLY FABRICATION
ACCESSORIES
EQUIPMENT AND PARTS
KITS
AIR BRAKE HOSE ASSY
BRASS

**The Gates eCrimp program** is a web based utility which allows users and distributors of Gates hydraulic and industrial hose products to find and print the most up to date crimp specifications with nothing more than an internet browser.

This program can be used to find crimp data for all Gates crimpers. Custom result may be printed by selecting the crimper, hose and coupling. Optionally results may also be limited by die set and working pressure.

The eCrimp web application can be directly accessed from a web browser by entering <http://eCrimp.Gates.com> for the website.

**The eCrimp mobile app** is available for download for the iPhone and iPad from the App Store.



EQUIPMENT
HOSE/CPLG. SELECTION
G8K COUPLINGS
GLOBAL SPIRAL COUPLINGS
STAINLESS STEEL SPIRAL
MEGACRIMP COUPLINGS
STAINLESS STEEL BRAID
POWER CRIMP COUPLINGS
FIELD ATTACHABLE G1 & G2 COUPLINGS
FIELD ATTACHABLE C5 COUPLINGS
C14 COUPLINGS
GL COUPLINGS
GLX COUPLINGS
PCTS THERMOPLASTIC COUPLINGS
POLARSEAL COUPLINGS (ACA)
POLARSEAL II COUPLINGS (ACC)
POLARSEAL II COUPLINGS (ACB)
POWER STEERING
ADAPTERS
QUICK DISCONNECT COUPLERS
BALL VALVES
LIVE SWIVEL
ASSEMBLY FABRICATION
ACCESSORIES
EQUIPMENT AND PARTS
KITS
AIR BRAKE HOSE ASSY
BRASS

### Male Pipe (NPTF - 30° Cone Seat)



Part No.	Descr.	Prod. No.	⊖		H1	L		C		
			"	mm		"	mm	"	mm	
G51100-0202	2PCTS-2MP	7336-11985	1/8	3.2	1/8-27	1/2	1.34	34.0	.74	18.8
G51100-0204	2PCTS-4MP	7336-11995	1/8	3.2	1/4-18	1/2	1.53	38.9	.93	23.6
G51100-0302	3PCTS-2MP	7336-12005	3/16	4.8	1/8-27	9/16	1.94	49.3	1.08	27.4
G51100-0304	3PCTS-4MP	7336-12015	3/16	4.8	1/4-18	11/16	2.13	54.1	1.27	32.3
G51100-0404	4PCTS-4MP	7336-12035	1/4	6.4	1/4-18	11/16	2.34	59.4	1.25	31.8
G51100-0406	4PCTS-6MP	7336-12045	1/4	6.4	3/8-18	3/4	2.44	62.0	1.35	34.3
G51100-0604	6PCTS-4MP	7336-12075	3/8	9.5	1/4-18	3/4	2.66	67.6	1.37	34.8
G51100-0606	6PCTS-6MP	7336-12085	3/8	9.5	3/8-18	3/4	2.66	67.6	1.37	34.8
G51100-0608	6PCTS-8MP	7336-12095	3/8	9.5	1/2-14	15/16	2.92	74.2	1.63	41.4
G51100-0808	8PCTS-8MP	7336-12105	1/2	12.7	1/2-14	15/16	3.13	79.5	1.48	37.6

### Male Pipe Swivel (NPTF - without 30° Cone Seat)

NOT TO BE USED AS A LIVE SWIVEL.



Part No.	Descr.	Prod. No.	⊖		H1	H2	L		C		
			"	mm			"	mm	"	mm	
G51105-0202	2PCTS-2MPX	7337-11985	1/8	3.2	1/8-27	1/2	23/32	1.93	49.0	1.33	33.8
G51105-0302	3PCTS-2MPX	7337-12005	3/16	4.8	1/8-27	23/32	23/32	2.50	63.5	1.50	38.1
G51105-0304	3PCTS-4MPX	7337-12015	3/16	4.8	1/4-18	23/32	23/32	2.72	69.1	1.86	47.2
G51105-0404	4PCTS-4MPX	7337-12025	1/4	6.4	1/4-18	5/8	23/32	2.84	72.1	1.78	45.2



### Female JIC 37° Flare Swivel



Part No.	Descr.	Prod. No.	⊖		🌀	H1	H2	L		C	
			"	mm				"	mm	"	mm
G51170-0203	2PCTS-3FJX	7338-11985	1/8	3.2	3/8-24	1/2	9/16	1.65	41.9	1.05	26.7
G51170-0406	4PCTS-6FJX	7338-12045	1/4	6.4	9/16-18	5/8	3/4	2.55	64.8	1.50	38.1
G51170-0812	8PCTS-12FJX	7338-12175	1/2	12.7	1 1/16-12	1 1/8	1 1/4	3.34	84.8	1.70	43.2
G51170-1212	12PCTS-12FJX	7338-01605	3/4	19.1	1 1/16-12	1 1/8	1 1/4	3.48	88.4	1.60	40.6
G51170-1616	16PCTS-16FJX	7338-01615	1	25.4	1 5/16-12	1 3/8	1 1/2	4.00	101.6	1.66	42.2

### Female JIC 37° Flare Swivel - 90° Bent Tube

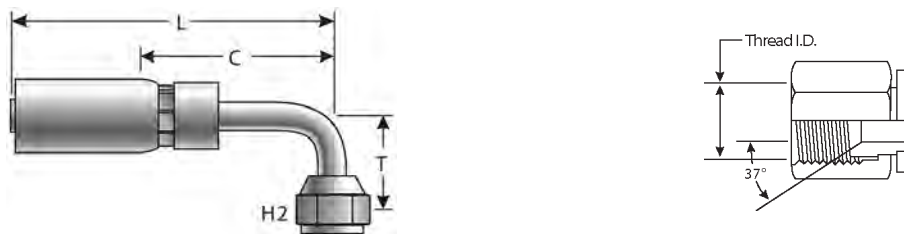

Part No.	Descr.	Prod. No.	⊖		🌀	H2	T		L		C	
			"	mm			"	mm	"	mm	"	mm
G51179-0304	3PCTS-4FJX90S	7338-12695	3/16	4.8	7/16-20	9/16	.78	19.8	2.45	62.2	1.58	40.1
G51179-0606	6PCTS-6FJX90S	7338-12785	3/8	9.5	9/16-18	11/16	.85	21.6	3.25	82.6	1.95	49.5
G51181-0808	8PCTS-8FJX90L	7338-12835	1/2	12.7	3/4-16	7/8	2.43	61.7	3.83	97.3	2.19	55.6

### Dual Seat Female JIC 37°/SAE 45° Flare Swivel - 45° Bent Tube

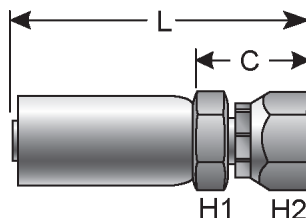

Part No.	Descr.	Prod. No.	⊖		🌀	H1	H2	L		C	
			"	mm				"	mm	"	mm
G51210-0204	2PCTS-4FJSX	7338-11995	1/8	3.2	7/16-20	1/2	5/8	1.73	44.0	1.12	28.5
G51210-0304	3PCTS-4FJSX	7338-12005	3/16	4.8	7/16-20	9/16	5/8	2.23	56.6	1.16	29.5
G51210-0404	4PCTS-4FJSX	7338-12025	1/4	6.4	7/16-20	5/8	5/8	2.53	64.3	1.47	37.3
G51210-0505	5PCTS-5FJSX	7338-12055	5/16	7.9	1/2-20	5/8	3/4	2.62	66.6	1.33	33.8

EQUIPMENT
HOSE/CPLG. SELECTION
G8K COUPLINGS
GLOBALSPIRAL COUPLINGS
STAINLESS STEEL SPIRAL
MEGACRIMP COUPLINGS
STAINLESS STEEL BRAID
POWER CRIMP COUPLINGS
FIELD ATTACHABLE G1 & G2 COUPLINGS
FIELD ATTACHABLE C5 COUPLINGS
C14 COUPLINGS
GL COUPLINGS
GLX COUPLINGS
<b>PCTS THERMOPLASTIC COUPLINGS</b>
POLARSEAL COUPLINGS (ACA)
POLARSEAL II COUPLINGS (ACC)
POLARSEAL II COUPLINGS (ACB)
POWER STEERING
ADAPTERS
QUICK DISCONNECT COUPLERS
BALL VALVES
LIVE SWIVEL
ASSEMBLY FABRICATION
ACCESSORIES
EQUIPMENT AND PARTS
KITS
AIR BRAKE HOSE ASSY
BRASS





**NOTES**

EQUIPMENT
HOSE/CPLG. SELECTION
G8K COUPLINGS
GLOBAL SPIRAL COUPLINGS
STAINLESS STEEL SPIRAL
MEGACRIMP COUPLINGS
STAINLESS STEEL BRAID
POWER CRIMP COUPLINGS
FIELD ATTACHABLE G1 & G2 COUPLINGS
FIELD ATTACHABLE C5 COUPLINGS
C14 COUPLINGS
GL COUPLINGS
GLX COUPLINGS
<b>PCTS THERMOPLASTIC COUPLINGS</b>
POLARSEAL COUPLINGS (ACA)
POLARSEAL II COUPLINGS (ACC)
POLARSEAL II COUPLINGS (ACB)
POWER STEERING
ADAPTERS
QUICK DISCONNECT COUPLERS
BALL VALVES
LIVE SWIVEL
ASSEMBLY FABRICATION
ACCESSORIES
EQUIPMENT AND PARTS
KITS
AIR BRAKE HOSE ASSY
BRASS



# HYDRAULIC HOSE FOR POLARSEAL® (ACA) COUPLINGS



EQUIPMENT
HOSE/CPLG. SELECTION
G8K COUPLINGS
GLOBALSPIRAL COUPLINGS
STAINLESS STEEL SPIRAL
MEGACRIMP COUPLINGS
STAINLESS STEEL BRAID
POWER CRIMP COUPLINGS
FIELD ATTACHABLE G1 & G2 COUPLINGS
FIELD ATTACHABLE C5 COUPLINGS
C14 COUPLINGS
GL COUPLINGS
GLX COUPLINGS
PCTS THERMOPLASTIC COUPLINGS
<b>POLARSEAL COUPLINGS (ACA)</b>
POLARSEAL II COUPLINGS (ACC)
POLARSEAL II COUPLINGS (ACB)
POWER STEERING
ADAPTERS
QUICK DISCONNECT COUPLERS
BALL VALVES
LIVE SWIVEL
ASSEMBLY FABRICATION
ACCESSORIES
EQUIPMENT AND PARTS
KITS
AIR BRAKE HOSE ASSY
BRASS

**The Gates eCrimp program** is a web based utility which allows users and distributors of Gates hydraulic and industrial hose products to find and print the most up to date crimp specifications with nothing more than an internet browser.

This program can be used to find crimp data for all Gates crimpers. Custom result may be printed by selecting the crimper, hose and coupling. Optionally results may also be limited by die set and working pressure.

The eCrimp web application can be directly accessed from a web browser by entering <http://eCrimp.Gates.com> for the website.

**The eCrimp mobile app** is available for download for the iPhone and iPad from the App Store.



EQUIPMENT
HOSE/CPLG. SELECTION
G8K COUPLINGS
GLOBAL SPIRAL COUPLINGS
STAINLESS STEEL SPIRAL
MEGACRIMP COUPLINGS
STAINLESS STEEL BRAID
POWER CRIMP COUPLINGS
FIELD ATTACHABLE G1 & G2 COUPLINGS
FIELD ATTACHABLE C5 COUPLINGS
C14 COUPLINGS
GL COUPLINGS
GLX COUPLINGS
PCTS THERMOPLASTIC COUPLINGS
<b>POLARSEAL COUPLINGS (ACA)</b>
POLARSEAL II COUPLINGS (ACC)
POLARSEAL II COUPLINGS (ACB)
POWER STEERING
ADAPTERS
QUICK DISCONNECT COUPLERS
BALL VALVES
LIVE SWIVEL
ASSEMBLY FABRICATION
ACCESSORIES
EQUIPMENT AND PARTS
KITS
AIR BRAKE HOSE ASSY
BRASS

### Male SAE 45° Flare - Aluminum

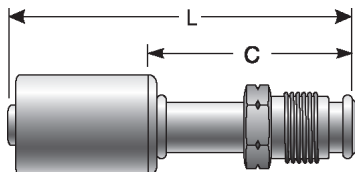

Part No.	Descr.	Prod. No.	⊖		L	C
			"	"	"	"
G45195-0606	6ACA-6MS	7332-00015	5/16	5/8-18	3.38	2.13
G45195-0808	8ACA-8MS	7332-00025	13/32	3/4-16	3.50	2.25
G45195-1010	10ACA-10MS	7332-00035	1/2	7/8-14	3.81	2.56
G45195-1212	12ACA-12MS	7332-00045	5/8	1 1/16-14	4.00	2.75

### Male SAE 45° Flare - 45° Bent Tube - Aluminum

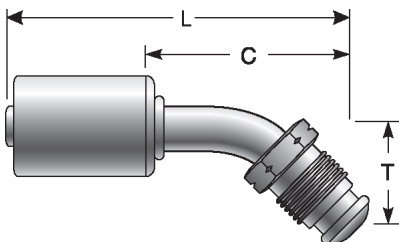

Part No.	Descr.	Prod. No.	⊖		T	L	C
			"	"	"	"	"
G45196-0606	6ACA-6MS45	7332-00055	5/16	5/8-18	.94	3.25	2.00
G45196-0808	8ACA-8MS45	7332-00065	13/32	3/4-16	1.06	3.50	2.25
G45196-1010	10ACA-10MS45	7332-00075	1/2	7/8-14	1.12	3.87	2.62
G45196-1212	12ACA-12MS45	7332-00085	5/8	1 1/16-14	1.25	4.25	3.00

### Male SAE 45° Flare - 90° Bent Tube - Aluminum

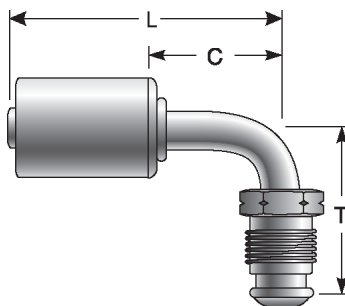

Part No.	Descr.	Prod. No.	⊖		T	L	C
			"	"	"	"	"
G45197-0606	6ACA-6MS90	7332-00095	5/16	5/8-18	1.75	2.56	1.31



Male SAE 45° Flare - 90° Bent Tube - Aluminum - Continued

Part No.	Descr.	Prod. No.	⊖		T	L	C
			"	"			
G45197-0808	8ACA-8MS90	7332-00105	13/32	3/4-16	1.81	2.75	1.50
G45197-1010	10ACA-10MS90	7332-00115	1/2	7/8-14	2.19	3.00	1.75
G45197-1212	12ACA-12MS90	7332-00125	5/8	1 1/16-14	2.45	3.25	2.00

Female SAE 45° Flare Swivel - Aluminum

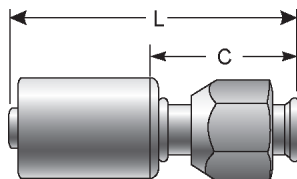

Part No.	Descr.	Prod. No.	⊖		L	C
			"	"		
G45200-0606	6ACA-6FSX	7332-00135	5/16	5/8-18	2.88	1.63
G45200-0608	6ACA-8FSX	7332-00145	5/16	3/4-16	2.69	1.44
G45200-0806	8ACA-6FSX	7332-02825	13/32	5/8-18	2.69	1.44
G45200-0808	8ACA-8FSX	7332-00155	13/32	3/4-16	2.69	1.44
G45200-1008	10ACA-8FSX	7332-02835	1/2	3/4-16	3.00	1.75
G45200-1010	10ACA-10FSX	7332-00165	1/2	7/8-14	3.00	1.75
G45200-1210	12ACA-10FSX	7332-00175	5/8	7/8-14	3.25	2.00
G45200-1212	12ACA-12FSX	7332-00185	5/8	1 1/16-14	3.25	2.00

Female SAE 45° Flare Swivel - Steel

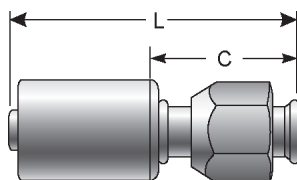

Part No.	Descr.	Prod. No.	⊖		L	C
			"	"		
G45200-0606S	6ACA-6FSX-S	7332-01755	5/16	5/8-18	2.88	1.60
G45200-0808S	8ACA-8FSX-S	7332-01765	13/32	3/4-16	2.69	1.44
G45200-1010S	10ACA-10FSX-S	7332-01775	1/2	7/8-14	3.00	1.75

EQUIPMENT
HOSE/CPLG. SELECTION
G8K COUPLINGS
GLOBALSPIRAL COUPLINGS
STAINLESS STEEL SPIRAL
MEGACRIMP COUPLINGS
STAINLESS STEEL BRAID
POWER CRIMP COUPLINGS
FIELD ATTACHABLE G1 & G2 COUPLINGS
FIELD ATTACHABLE C5 COUPLINGS
C14 COUPLINGS
GL COUPLINGS
GLX COUPLINGS
PCTS THERMOPLASTIC COUPLINGS
POLARSEAL COUPLINGS (ACA)
POLARSEAL II COUPLINGS (ACC)
POLARSEAL II COUPLINGS (ACB)
POWER STEERING
ADAPTERS
QUICK DISCONNECT COUPLERS
BALL VALVES
LIVE SWIVEL
ASSEMBLY FABRICATION
ACCESSORIES
EQUIPMENT AND PARTS
KITS
AIR BRAKE HOSE ASSY
BRASS

## Female SAE 45° Flare Swivel - 45° Bent Tube - Aluminum

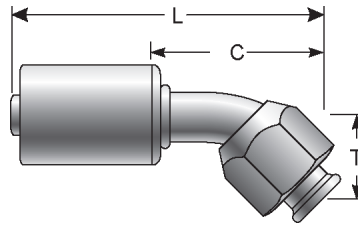

Part No.	Descr.	Prod. No.			T	L	C
			"	"			
G45202-0606	6ACA-6FSX45	7332-00195	5/16	5/8-18	.56	2.87	1.62
G45202-0806	8ACA-6FSX45	7332-02855	13/32	5/8-18	.63	3.04	1.79
G45202-0808	8ACA-8FSX45	7332-00205	13/32	3/4-16	.63	3.07	1.82
G45202-1010	10ACA-10FSX45	7332-00215	1/2	7/8-14	.88	3.63	2.38
G45202-1210	12ACA-10FSX45	7332-02875	5/8	7/8-14	1.00	3.97	2.72
G45202-1212	12ACA-12FSX45	7332-00225	5/8	1 1/16-14	1.00	4.00	2.75

## Female SAE 45° Flare Swivel - 90° Bent Tube - Aluminum

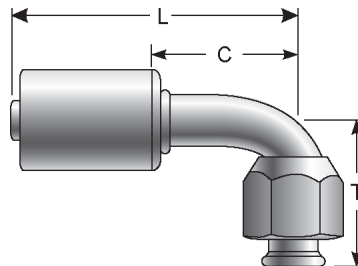

Part No.	Descr.	Prod. No.			T	L	C
			"	"			
G45205-0606	6ACA-6FSX90	7332-00235	5/16	5/8-18	1.06	2.56	1.31
G45205-0608	6ACA-8FSX90	7332-00245	5/16	3/4-16	1.25	2.75	1.50
G45205-0806	8ACA-6FSX90	7332-02885	13/32	5/8-18	1.25	2.75	1.50
G45205-0808	8ACA-8FSX90	7332-00255	13/32	3/4-16	1.25	2.75	1.50
G45205-1008	10ACA-8FSX90	7332-02895	1/2	3/4-16	1.50	3.00	1.75
G45205-1010	10ACA-10FSX90	7332-00265	1/2	7/8-14	1.50	3.00	1.75
G45205-1210	12ACA-10FSX90	7332-00275	5/8	7/8-14	1.50	3.25	2.00
G45205-1212	12ACA-12FSX90	7332-00285	5/8	1 1/16-14	1.50	3.85	2.00



### Female SAE 45° Flare Swivel - 90° Bent Tube - Steel

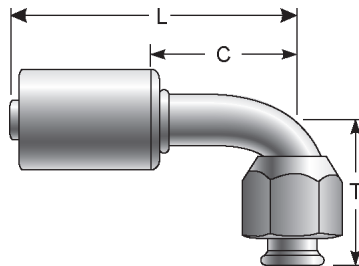

Part No.	Descr.	Prod. No.	⊖		T	L	C
			"	"	"	"	"
G45205-0606S	6ACA-6FSX90-S	7332-01785	5/16	5/8-18	1.06	2.56	1.31
G45205-0808S	8ACA-8FSX90-S	7332-01795	13/32	3/4-16	1.25	2.75	1.50
G45205-1010S	10ACA-10FSX90-S	7332-01805	1/2	7/8-14	1.50	3.00	1.75

### Male SAE Flareless Assembly - Aluminum

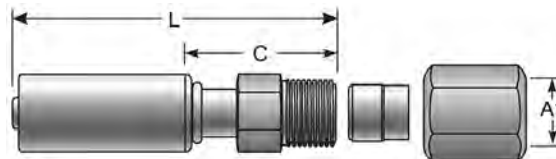

Part No.	Descr.	Prod. No.	⊖		A1	L	C
			"	"	"	"	"
G45510-0606	6ACA-6MFA	7332-00295	5/16	9/16-18	3/8	2.69	1.44
G45510-0608	6ACA-8MFA	7332-02905	5/16	3/4-16	1/2	2.81	1.56
G45510-0806	8ACA-6MFA	7332-02915	13/32	9/16-18	3/8	2.75	1.50
G45510-0808	8ACA-8MFA	7332-00305	13/32	3/4-16	1/2	2.88	1.63
G45510-0810	8ACA-10MFA	7332-00315	13/32	7/8-14	5/8	3.00	1.75
G45510-1008	10ACA-8MFA	7332-00325	1/2	3/4-16	1/2	2.94	1.69
G45510-1010	10ACA-10MFA	7332-00335	1/2	7/8-14	5/8	3.00	1.75
G45510-1210	12ACA-10MFA	7332-00345	5/8	7/8-14	5/8	3.13	1.88
G45510-1212	12ACA-12MFA	7332-00355	5/8	1 1/16-12	3/4	3.25	2.00

EQUIPMENT
HOSE/CPLG. SELECTION
G8K COUPLINGS
GLOBALSPIRAL COUPLINGS
STAINLESS STEEL SPIRAL
MEGACRIMP COUPLINGS
STAINLESS STEEL BRAID
POWER CRIMP COUPLINGS
FIELD ATTACHABLE G1 & G2 COUPLINGS
FIELD ATTACHABLE C5 COUPLINGS
C14 COUPLINGS
GL COUPLINGS
GLX COUPLINGS
PCTS THERMOPLASTIC COUPLINGS
<b>POLARSEAL COUPLINGS (ACA)</b>
POLARSEAL II COUPLINGS (ACC)
POLARSEAL II COUPLINGS (ACB)
POWER STEERING
ADAPTERS
QUICK DISCONNECT COUPLERS
BALL VALVES
LIVE SWIVEL
ASSEMBLY FABRICATION
ACCESSORIES
EQUIPMENT AND PARTS
KITS
AIR BRAKE HOSE ASSY
BRASS



EQUIPMENT
HOSE/CPLG. SELECTION
G8K COUPLINGS
GLOBALSPIRAL COUPLINGS
STAINLESS STEEL SPIRAL
MEGACRIMP COUPLINGS
STAINLESS STEEL BRAID
POWER CRIMP COUPLINGS
FIELD ATTACHABLE G1 & G2 COUPLINGS
FIELD ATTACHABLE C5 COUPLINGS
C14 COUPLINGS
GL COUPLINGS
GLX COUPLINGS
PCTS THERMOPLASTIC COUPLINGS
<b>POLARSEAL COUPLINGS (ACA)</b>
POLARSEAL II COUPLINGS (ACC)
POLARSEAL II COUPLINGS (ACB)
POWER STEERING
ADAPTERS
QUICK DISCONNECT COUPLERS
BALL VALVES
LIVE SWIVEL
ASSEMBLY FABRICATION
ACCESSORIES
EQUIPMENT AND PARTS
KITS
AIR BRAKE HOSE ASSY
BRASS

## Male SAE Flareless Assembly - 90° Block - Aluminum

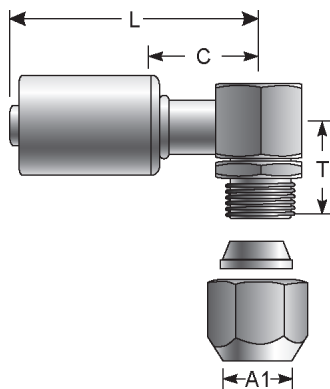

Part No.	Descr.	Prod. No.	⊖	🌀	A1	T	L	C
			"	"				
G45511-0606	6ACA-6MFA90	7332-00365	5/16	9/16-18	3/8	.78	2.24	.99
G45511-0608	6ACA-8MFA90	7332-02925	5/16	3/4-16	1/2	.96	2.31	1.06
G45511-0806	8ACA-6MFA90	7332-02935	13/32	9/16-18	3/8	.78	2.28	1.03
G45511-0808	8ACA-8MFA90	7332-00375	13/32	3/4-16	1/2	.96	2.37	1.12
G45511-0810	8ACA-10MFA90	7332-00385	13/32	7/8-14	5/8	1.08	2.43	1.18
G45511-1008	10ACA-8MFA90	7332-00395	1/2	3/4-16	1/2	.96	2.38	1.13
G45511-1010	10ACA-10MFA90	7332-00405	1/2	7/8-14	5/8	1.08	2.44	1.19
G45511-1210	12ACA-10MFA90	7332-00415	5/8	7/8-14	5/8	1.08	2.56	1.31
G45511-1212	12ACA-12MFA90	7332-00425	5/8	1 1/16-12	3/4	1.19	2.66	1.41

## Female Braze-On Stems - Aluminum

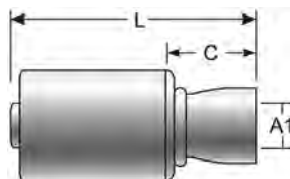

Part No.	Descr.	Prod. No.	⊖	A1	L	C
			"			
G45527-0606	6ACA-6FBO	7332-02945	5/16	3/8	2.10	.85
G45527-0808	8ACA-8FBO	7332-02955	13/32	1/2	2.10	.85
G45527-1010	10ACA-10FBO	7332-02965	1/2	5/8	2.10	.85
G45527-1210	12ACA-10FBO	7332-02975	5/8	5/8	2.10	.85
G45527-1212	12ACA-12FBO	7332-02985	5/8	3/4	2.10	.85





### Female Braze-On Stems - Steel

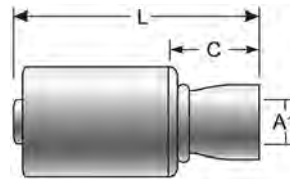

Part No.	Descr.	Prod. No.	⊖	A1	L	C
			"	"	"	"
G45527-0606S	6ACA-6FBO-S	7332-01905	5/16	3/8	2.10	.85
G45527-0808S	8ACA-8FBO-S	7332-01915	13/32	1/2	2.10	.85
G45527-1010S	10ACA-10FBO-S	7332-01925	1/2	5/8	2.10	.85
G45527-1210S	12ACA-10FBO-S	7332-01945	5/8	5/8	2.10	.85
G45527-1212S	12ACA-12FBO-S	7332-01935	5/8	3/4	2.10	.85

### Hose Length Extender - Aluminum

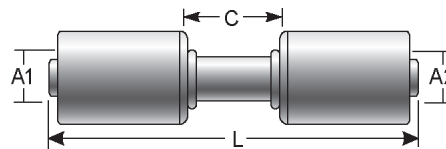

Part No.	Descr.	Prod. No.	⊖	A1	A2	L	C
			"	"	"	"	"
G45535-0606	6ACA-6HLE	7332-01385	5/16	5/16	5/16	4.00	1.50
G45535-0608	6ACA-8HLE	7332-01395	5/16	5/16	13/32	4.00	1.50
G45535-0808	8ACA-8HLE	7332-01405	13/32	13/32	13/32	4.00	1.50
G45535-0810	8ACA-10HLE	7332-01415	13/32	13/32	1/2	4.13	1.63
G45535-1010	10ACA-10HLE	7332-01425	1/2	1/2	1/2	4.13	1.63
G45535-1210	12ACA-10HLE	7332-02995	5/8	5/8	1/2	4.25	1.75
G45535-1212	12ACA-12HLE	7332-01435	5/8	5/8	5/8	4.25	1.75

### Hose Length Extender - Steel

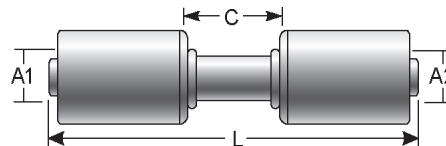

Part No.	Descr.	Prod. No.	⊖	A1	A2	L	C
			"	"	"	"	"
G45535-1210S	12ACA-10HLE-S	7332-04485	5/8	5/8	1/2	1.75	5.27

- EQUIPMENT
- HOSE/CPLG. SELECTION
- G8K COUPLINGS
- GLOBALSPIRAL COUPLINGS
- STAINLESS STEEL SPIRAL
- MEGACRIMP COUPLINGS
- STAINLESS STEEL BRAID
- POWER CRIMP COUPLINGS
- FIELD ATTACHABLE G1 & G2 COUPLINGS
- FIELD ATTACHABLE C5 COUPLINGS
- C14 COUPLINGS
- GL COUPLINGS
- GLX COUPLINGS
- PCTS THERMOPLASTIC COUPLINGS
- POLARSEAL COUPLINGS (ACA)**
- POLARSEAL II COUPLINGS (ACC)
- POLARSEAL II COUPLINGS (ACB)
- POWER STEERING
- ADAPTERS
- QUICK DISCONNECT COUPLERS
- BALL VALVES
- LIVE SWIVEL
- ASSEMBLY FABRICATION
- ACCESSORIES
- EQUIPMENT AND PARTS
- KITS
- AIR BRAKE HOSE ASSY
- BRASS

EQUIPMENT
HOSE/CPLG. SELECTION
G8K COUPLINGS
GLOBAL SPIRAL COUPLINGS
STAINLESS STEEL SPIRAL
MEGACRIMP COUPLINGS
STAINLESS STEEL BRAID
POWER CRIMP COUPLINGS
FIELD ATTACHABLE G1 & G2 COUPLINGS
FIELD ATTACHABLE C5 COUPLINGS
C14 COUPLINGS
GL COUPLINGS
GLX COUPLINGS
PCTS THERMOPLASTIC COUPLINGS
<b>POLARSEAL COUPLINGS (ACA)</b>
POLARSEAL II COUPLINGS (ACC)
POLARSEAL II COUPLINGS (ACB)
POWER STEERING
ADAPTERS
QUICK DISCONNECT COUPLERS
BALL VALVES
LIVE SWIVEL
ASSEMBLY FABRICATION
ACCESSORIES
EQUIPMENT AND PARTS
KITS
AIR BRAKE HOSE ASSY
BRASS

### Hose Length Extender - 90° Bent Tube - Aluminum

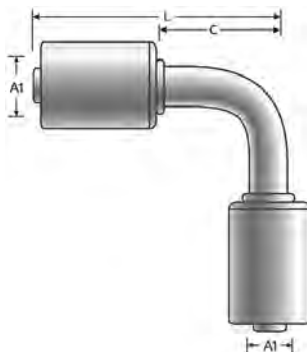

Part No.	Descr.	Prod. No.	⊖	A1	L	C
			"	"	"	"
G45537-0606	6ACA-6HLE90	7332-01445	5/16	5/16	2.50	1.25
G45537-0808	8ACA-8HLE90	7332-01455	13/32	13/32	2.62	1.37
G45537-1010	10ACA-10HLE90	7332-01465	1/2	1/2	2.88	1.63
G45537-1212	12ACA-12HLE90	7332-01475	5/8	5/8	3.25	2.00

### Hose Length Extender with Sight Glass - Aluminum

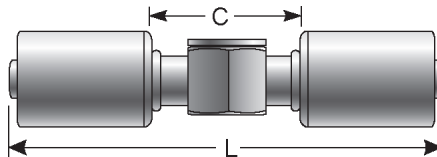

Part No.	Descr.	Prod. No.	⊖	L	C
			"	"	"
G45538-0606	6ACA-6HLESG	7332-01485	5/16	4.12	1.62



### Hose Length Extender - Tee - Aluminum

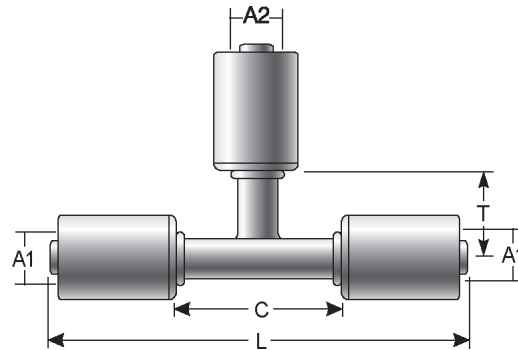

Part No.	Descr.	Prod. No.	⊖	A1	A2	T	L	C
			"					
G45539-0606	6ACA-6HLET	7332-02295	5/16	5/16	5/16	1.13	4.75	2.25
G45539-0808	8ACA-8HLET	7332-02305	13/32	13/32	13/32	1.19	4.88	2.38
G45539-1010	10ACA-10HLET	7332-02315	1/2	1/2	1/2	1.25	5.00	2.50
G45539-1210	12ACA-10HLET	7332-03015	5/8	5/8	1/2	1.34	5.25	2.75
G45539-1212	12ACA-12HLET	7332-02325	5/8	5/8	5/8	1.37	5.25	2.75

### Hose Length Extender - 180° Bent Tube - Aluminum

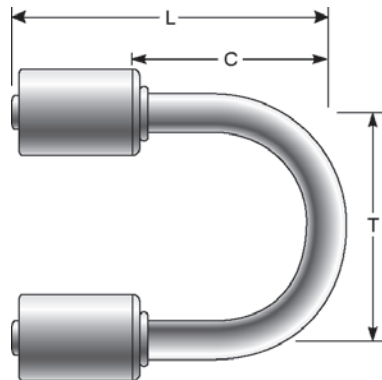

Part No.	Descr.	Prod. No.	⊖	T	L	C
			"			
G45541-0606	6ACA-6HLE180	7332-02255	5/16	3.00	3.88	2.63
G45541-0808	8ACA-8HLE180	7332-02265	13/32	3.00	4.00	2.75
G45541-1212	12ACA-12HLE180	7332-02285	5/8	3.00	4.50	3.25

EQUIPMENT
HOSE/CPLG. SELECTION
G8K COUPLINGS
GLOBALSPIRAL COUPLINGS
STAINLESS STEEL SPIRAL
MEGACRIMP COUPLINGS
STAINLESS STEEL BRAID
POWER CRIMP COUPLINGS
FIELD ATTACHABLE G1 & G2 COUPLINGS
FIELD ATTACHABLE C5 COUPLINGS
C14 COUPLINGS
GL COUPLINGS
GLX COUPLINGS
PCTS THERMOPLASTIC COUPLINGS
<b>POLARSEAL COUPLINGS (ACA)</b>
POLARSEAL II COUPLINGS (ACC)
POLARSEAL II COUPLINGS (ACB)
POWER STEERING
ADAPTERS
QUICK DISCONNECT COUPLERS
BALL VALVES
LIVE SWIVEL
ASSEMBLY FABRICATION
ACCESSORIES
EQUIPMENT AND PARTS
KITS
AIR BRAKE HOSE ASSY
BRASS



EQUIPMENT
HOSE/CPLG. SELECTION
G8K COUPLINGS
GLOBAL SPIRAL COUPLINGS
STAINLESS STEEL SPIRAL
MEGACRIMP COUPLINGS
STAINLESS STEEL BRAID
POWER CRIMP COUPLINGS
FIELD ATTACHABLE G1 & G2 COUPLINGS
FIELD ATTACHABLE C5 COUPLINGS
C14 COUPLINGS
GL COUPLINGS
GLX COUPLINGS
PCTS THERMOPLASTIC COUPLINGS
<b>POLARSEAL COUPLINGS (ACA)</b>
POLARSEAL II COUPLINGS (ACC)
POLARSEAL II COUPLINGS (ACB)
POWER STEERING
ADAPTERS
QUICK DISCONNECT COUPLERS
BALL VALVES
LIVE SWIVEL
ASSEMBLY FABRICATION
ACCESSORIES
EQUIPMENT AND PARTS
KITS
AIR BRAKE HOSE ASSY
BRASS

## Male SAE Tube O-Ring Nut Swivel with R134a Service Port - Aluminum

O-Ring not included. Must be ordered separately.

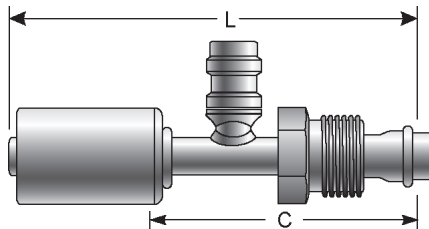

Part No.	Descr.	Prod. No.			L	C
			"	"		
G45580-0606	6ACA-6MTON134SP	7332-03025	5/16	5/8-18	3.35	2.10
G45580-0808	8ACA-8MTON134SP	7332-03035	13/32	3/4-16	3.35	2.10
G45580-1010	10ACA-10MTON134SP	7332-03045	1/2	7/8-14	3.59	2.34
G45580-1212	12ACA-12MTON134SP	7332-03055	5/8	1 1/16-14	3.72	2.47

## Male SAE Tube O-Ring Nut Swivel with R134a Service Port - 90° Bent Tube - Aluminum

O-Ring not included. Must be ordered separately.

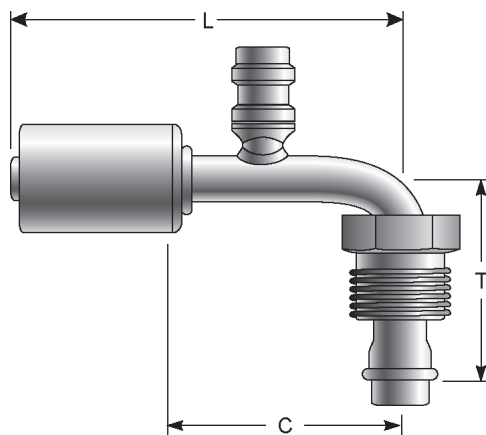

Part No.	Descr.	Prod. No.			T	L	C
			"	"			
G45582-1010	10ACA-10MTON134SP90	7332-02585	1/2	7/8-14	1.50	3.85	2.60



### Male SAE Tube O-Ring Nut Swivel - Aluminum

O-Ring not included. Must be ordered separately.

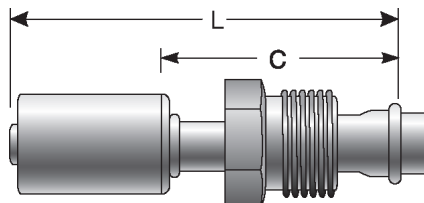

Part No.	Descr.	Prod. No.	⊖	🌀	L	C
			"	"		
G45583-0606	6ACA-6MTON	7332-00435	5/16	5/8-18	3.19	1.94
G45583-0607	6ACA-7MTON	7332-02115	5/16	11/16-16	3.00	1.75
G45583-0608	6ACA-8MTON	7332-03065	5/16	3/4-16	3.25	2.00
G45583-0806	8ACA-6MTON	7332-03075	13/32	5/8-18	3.25	2.00
G45583-0808	8ACA-8MTON	7332-00445	13/32	3/4-16	3.25	2.00
G45583-1010	10ACA-10MTON	7332-00455	1/2	7/8-14	3.38	2.13
G45583-1210	12ACA-10MTON	7332-03085	5/8	7/8-14	3.88	2.63
G45583-1212	12ACA-12MTON	7332-00465	5/8	1 1/16-14	3.88	2.63

### Male SAE Tube O-Ring Nut Swivel - Steel

O-Ring not included. Must be ordered separately.

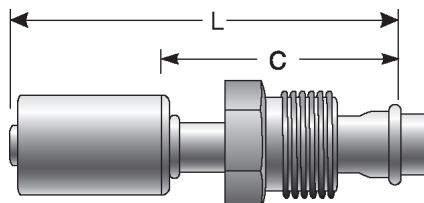

Part No.	Descr.	Prod. No.	⊖	🌀	L	C
			"	"		
G45583-0606S	6ACA-6MTON-S	7332-01285	5/16	5/8-18	3.19	1.94
G45583-0607S	6ACA-7MTON-S	7332-02125	5/16	11/16-16	3.00	1.75
G45583-1010S	10ACA-10MTON-S	7332-01865	1/2	7/8-14	3.38	2.13

- EQUIPMENT
- HOSE/CPLG. SELECTION
- G8K COUPLINGS
- GLOBALSPIRAL COUPLINGS
- STAINLESS STEEL SPIRAL
- MEGACRIMP COUPLINGS
- STAINLESS STEEL BRAID
- POWER CRIMP COUPLINGS
- FIELD ATTACHABLE G1 & G2 COUPLINGS
- FIELD ATTACHABLE C5 COUPLINGS
- C14 COUPLINGS
- GL COUPLINGS
- GLX COUPLINGS
- PCTS THERMOPLASTIC COUPLINGS
- POLARSEAL COUPLINGS (ACA)**
- POLARSEAL II COUPLINGS (ACC)
- POLARSEAL II COUPLINGS (ACB)
- POWER STEERING
- ADAPTERS
- QUICK DISCONNECT COUPLERS
- BALL VALVES
- LIVE SWIVEL
- ASSEMBLY FABRICATION
- ACCESSORIES
- EQUIPMENT AND PARTS
- KITS
- AIR BRAKE HOSE ASSY
- BRASS

EQUIPMENT
HOSE/CPLG. SELECTION
G8K COUPLINGS
GLOBAL SPIRAL COUPLINGS
STAINLESS STEEL SPIRAL
MEGACRIMP COUPLINGS
STAINLESS STEEL BRAID
POWER CRIMP COUPLINGS
FIELD ATTACHABLE G1 & G2 COUPLINGS
FIELD ATTACHABLE C5 COUPLINGS
C14 COUPLINGS
GL COUPLINGS
GLX COUPLINGS
PCTS THERMOPLASTIC COUPLINGS
<b>POLARSEAL COUPLINGS (ACA)</b>
POLARSEAL II COUPLINGS (ACC)
POLARSEAL II COUPLINGS (ACB)
POWER STEERING
ADAPTERS
QUICK DISCONNECT COUPLERS
BALL VALVES
LIVE SWIVEL
ASSEMBLY FABRICATION
ACCESSORIES
EQUIPMENT AND PARTS
KITS
AIR BRAKE HOSE ASSY
BRASS

## Male SAE Tube O-Ring Nut - 45° Bent Tube - Aluminum

O-Ring not included. Must be ordered separately.

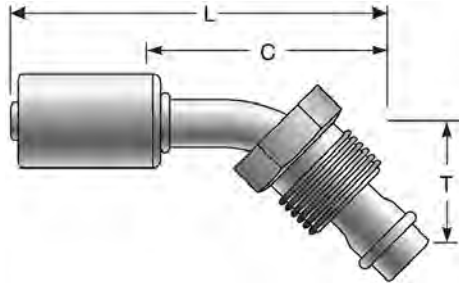

Part No.	Descr.	Prod. No.	⊖	🌀	T	L	C
			"	"			
G45584-0606	6ACA-6MTON45	7332-00475	5/16	5/8-18	.88	3.19	1.94
G45584-0608	6ACA-8MTON45	7332-03095	5/16	3/4-16	1.00	3.47	2.22
G45584-0806	8ACA-6MTON45	7332-03105	13/32	5/8-18	1.00	3.47	2.22
G45584-0808	8ACA-8MTON45	7332-00485	13/32	3/4-16	1.00	3.44	2.19
G45584-1010	10ACA-10MTON45	7332-00495	1/2	7/8-14	1.06	3.81	2.56
G45584-1212	12ACA-12MTON45	7332-00505	5/8	1 1/16-14	1.19	4.19	2.94

## Male SAE Tube O-Ring Nut - 45° Bent Tube - Steel

O-Ring not included. Must be ordered separately.

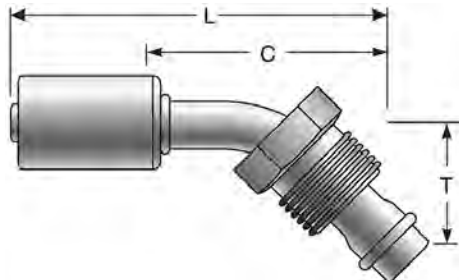

Part No.	Descr.	Prod. No.	⊖	🌀	T	L	C
			"	"			
G45584-0606S	6ACA-6MTON45-S	7332-04415	5/16	5/8-18	.88	1.69	4.03
G45584-1010S	10ACA-10MTON45-S	7332-04425	1/2	7/8-14	1.06	2.31	4.63



### Male SAE Tube O-Ring Nut - 90° Bent Tube - Aluminum

O-Ring not included. Must be ordered separately.

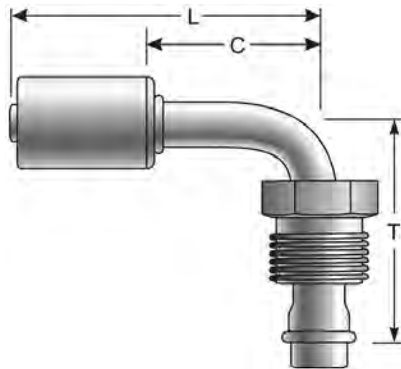

Part No.	Descr.	Prod. No.	⊖	🌀	T	L	C
			"	"	"	"	"
G45585-0606	6ACA-6MTON90	7332-00515	5/16	5/8-18	1.63	2.56	1.31
G45585-0607	6ACA-7MTON90	7332-03115	5/16	11/16-16	1.56	2.56	1.31
G45585-0608	6ACA-8MTON90	7332-03125	5/16	3/4-16	1.88	2.75	1.50
G45585-0806	8ACA-6MTON90	7332-03135	13/32	5/8-18	1.88	2.75	1.50
G45585-0808	8ACA-8MTON90	7332-00525	13/32	3/4-16	1.88	2.75	1.50
G45585-1010	10ACA-10MTON90	7332-00535	1/2	7/8-14	2.12	3.00	1.75
G45585-1210	12ACA-10MTON90	7332-03145	5/8	7/8-14	2.25	3.25	2.00
G45585-1212	12ACA-12MTON90	7332-00545	5/8	1 1/16-14	2.25	3.25	2.00

### Male SAE Tube O-Ring Nut - 90° Bent Tube - Steel

O-Ring not included. Must be ordered separately.

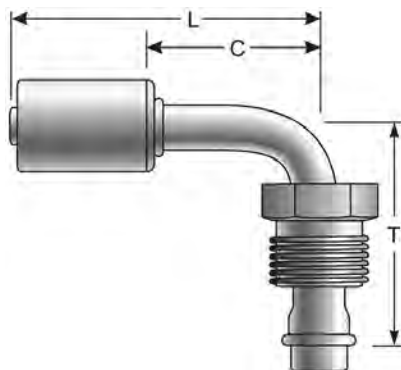

Part No.	Descr.	Prod. No.	⊖	🌀	T	L	C
			"	"	"	"	"
G45585-0606S	6ACA-6MTON90-S	7332-01295	5/16	5/8-18	1.63	2.56	1.31
G45585-0808S	8ACA-8MTON90-S	7332-04435	13/32	3/4-16	1.88	1.25	4.73
G45585-1010S	10ACA-10MTON90-S	7332-01875	1/2	7/8-14	2.12	3.00	1.75

- EQUIPMENT
- HOSE/CPLG. SELECTION
- G8K COUPLINGS
- GLOBALSPIRAL COUPLINGS
- STAINLESS STEEL SPIRAL
- MEGACRIMP COUPLINGS
- STAINLESS STEEL BRAID
- POWER CRIMP COUPLINGS
- FIELD ATTACHABLE G1 & G2 COUPLINGS
- FIELD ATTACHABLE C5 COUPLINGS
- C14 COUPLINGS
- GL COUPLINGS
- GLX COUPLINGS
- PCTS THERMOPLASTIC COUPLINGS
- POLARSEAL COUPLINGS (ACA)**
- POLARSEAL II COUPLINGS (ACC)
- POLARSEAL II COUPLINGS (ACB)
- POWER STEERING
- ADAPTERS
- QUICK DISCONNECT COUPLERS
- BALL VALVES
- LIVE SWIVEL
- ASSEMBLY FABRICATION
- ACCESSORIES
- EQUIPMENT AND PARTS
- KITS
- AIR BRAKE HOSE ASSY
- BRASS





EQUIPMENT
HOSE/CPLG. SELECTION
G8K COUPLINGS
GLOBAL SPIRAL COUPLINGS
STAINLESS STEEL SPIRAL
MEGACRIMP COUPLINGS
STAINLESS STEEL BRAID
POWER CRIMP COUPLINGS
FIELD ATTACHABLE G1 & G2 COUPLINGS
FIELD ATTACHABLE C5 COUPLINGS
C14 COUPLINGS
GL COUPLINGS
GLX COUPLINGS
PCTS THERMOPLASTIC COUPLINGS
<b>POLARSEAL COUPLINGS (ACA)</b>
POLARSEAL II COUPLINGS (ACC)
POLARSEAL II COUPLINGS (ACB)
POWER STEERING
ADAPTERS
QUICK DISCONNECT COUPLERS
BALL VALVES
LIVE SWIVEL
ASSEMBLY FABRICATION
ACCESSORIES
EQUIPMENT AND PARTS
KITS
AIR BRAKE HOSE ASSY
BRASS

## Female SAE Tube O-Ring Nut Swivel with R12 Service Port - Aluminum

O-Ring not included. Must be ordered separately.  
 Service Ports: High Side; -6, -8 Hose; 3/8" Schrader Valve  
 Service Ports: Low Side; -10, -12 Hose; 1/4" Schrader Valve

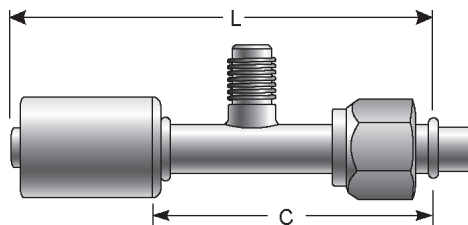

Part No.	Descr.	Prod. No.	⊖	🌀	L	C
			"	"	"	"
G45586-0606	6ACA-6FTONR12SP	7332-01985	5/16	5/8-18	3.38	2.13
G45586-0808	8ACA-8FTONR12SP	7332-01995	13/32	3/4-16	3.38	2.13
G45586-1010	10ACA-10FTONR12SP	7332-02005	1/2	7/8-14	3.62	2.37

## Female SAE Tube O-Ring Nut Swivel with R12 Service Port - 90° Bent Tube - Aluminum

O-Ring not included. Must be ordered separately.

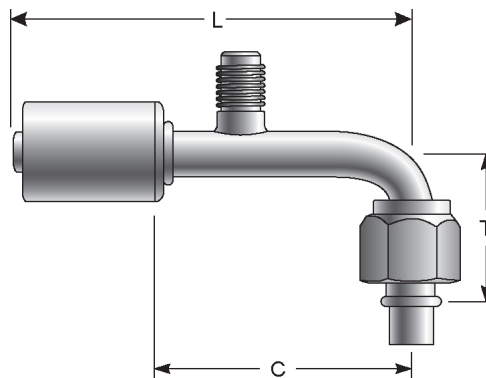



Part No.	Descr.	Prod. No.	⊖	🌀	T	L	C
			"	"	"	"	"
G45587-0606	6ACA-6FTONR12SP90	7332-02015	5/16	5/8-18	1.12	3.62	2.37
G45587-0808	8ACA-8FTONR12SP90	7332-02025	13/32	3/4-16	1.31	3.62	2.37
G45587-1010	10ACA-10FTONR12SP90	7332-02035	1/2	7/8-14	1.50	3.88	2.63
G45587-1210	12ACA-10FTONR12SP90	7332-02045	5/8	7/8-14	1.75	4.19	2.94

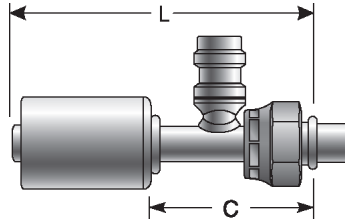

## Female SAE Tube O-Ring Nut Swivel with R134a Service Port - Aluminum

O-Ring not included. Must be ordered separately.



Part No.	Descr.	Prod. No.	⊖		L	C
			"	"		
G45588-0606	6ACA-6FTON134SP	7332-00555	5/16	5/8-18	3.30	2.05
G45588-0808	8ACA-8FTON134SP	7332-00565	13/32	3/4-16	3.38	2.13
G45588-1010	10ACA-10FTON134SP	7332-00575	1/2	7/8-14	3.62	2.37
G45588-1210	12ACA-10FTON134SP	7332-00585	5/8	7/8-14	3.75	2.50

## Female SAE Tube O-Ring Nut Swivel with R134a Service Port - Steel

O-Ring not included. Must be ordered separately.

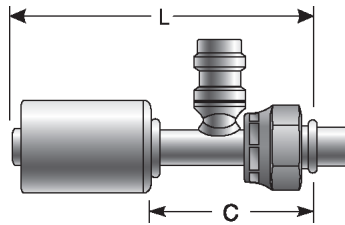

Part No.	Descr.	Prod. No.	⊖		L	C
			"	"		
G45588-0606S	6ACA-6FTON134SP-S	7332-04405	5/16	5/8-18	1.88	3.98
G45588-0808S	8ACA-8FTON134SP-S	7332-02685	13/32	3/4-16	3.38	2.13
G45588-1010S	10ACA-10FTON134SP-S	7332-02695	1/2	7/8-14	3.62	2.37

EQUIPMENT
HOSE/CPLG. SELECTION
G8K COUPLINGS
GLOBALSPIRAL COUPLINGS
STAINLESS STEEL SPIRAL
MEGACRIMP COUPLINGS
STAINLESS STEEL BRAID
POWER CRIMP COUPLINGS
FIELD ATTACHABLE G1 & G2 COUPLINGS
FIELD ATTACHABLE C5 COUPLINGS
C14 COUPLINGS
GL COUPLINGS
GLX COUPLINGS
PCTS THERMOPLASTIC COUPLINGS
<b>POLARSEAL COUPLINGS (ACA)</b>
POLARSEAL II COUPLINGS (ACC)
POLARSEAL II COUPLINGS (ACB)
POWER STEERING
ADAPTERS
QUICK DISCONNECT COUPLERS
BALL VALVES
LIVE SWIVEL
ASSEMBLY FABRICATION
ACCESSORIES
EQUIPMENT AND PARTS
KITS
AIR BRAKE HOSE ASSY
BRASS



EQUIPMENT
HOSE/CPLG. SELECTION
G8K COUPLINGS
GLOBAL SPIRAL COUPLINGS
STAINLESS STEEL SPIRAL
MEGACRIMP COUPLINGS
STAINLESS STEEL BRAID
POWER CRIMP COUPLINGS
FIELD ATTACHABLE G1 & G2 COUPLINGS
FIELD ATTACHABLE C5 COUPLINGS
C14 COUPLINGS
GL COUPLINGS
GLX COUPLINGS
PCTS THERMOPLASTIC COUPLINGS
<b>POLARSEAL COUPLINGS (ACA)</b>
POLARSEAL II COUPLINGS (ACC)
POLARSEAL II COUPLINGS (ACB)
POWER STEERING
ADAPTERS
QUICK DISCONNECT COUPLERS
BALL VALVES
LIVE SWIVEL
ASSEMBLY FABRICATION
ACCESSORIES
EQUIPMENT AND PARTS
KITS
AIR BRAKE HOSE ASSY
BRASS

## Female SAE Tube O-Ring Nut Swivel with R134a Service Port - 90° Bent Tube - Aluminum

O-Ring not included. Must be ordered separately.

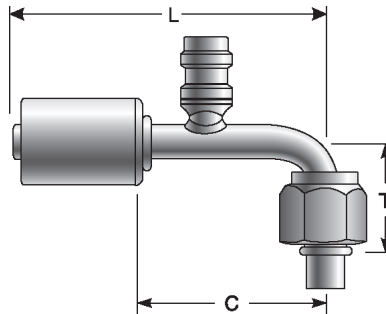

Part No.	Descr.	Prod. No.	⊖	🌀	T	L	C
			"	"	"	"	"
G45589-0606	6ACA-6FTON134SP90	7332-00595	5/16	5/8-18	1.12	3.62	2.37
G45589-0808	8ACA-8FTON134SP90	7332-00605	13/32	3/4-16	1.31	3.62	2.37
G45589-1010	10ACA-10FTON134SP90	7332-00615	1/2	7/8-14	1.50	3.88	2.63
G45589-1210	12ACA-10FTON134SP90	7332-00625	5/8	7/8-14	1.75	4.19	2.94

## Female SAE Tube O-Ring Nut Swivel with R134a Service Port - 90° Bent Tube - Steel

O-Ring not included. Must be ordered separately.

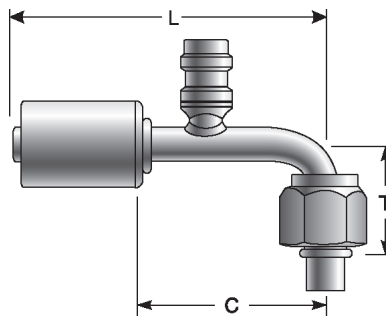

Part No.	Descr.	Prod. No.	⊖	🌀	T	L	C
			"	"	"	"	"
G45589-0606S	6ACA-6FTON134SP90-S	7332-02075	5/16	5/8-18	1.12	3.62	2.37
G45589-0808S	8ACA-8FTON134SP90-S	7332-01705	13/32	3/4-16	1.50	3.62	2.37
G45589-1010S	10ACA-10FTON134SP90-S	7332-01715	1/2	7/8-14	1.75	3.88	2.63
G45589-1210S	12ACA-10FTON134SP90-S	7332-02085	5/8	7/8-14	1.75	4.19	2.94



## Female SAE Tube O-Ring Nut Swivel - Aluminum

O-Ring not included. Must be ordered separately.

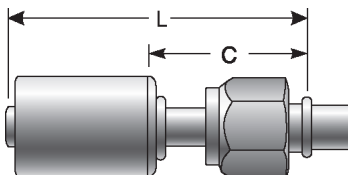

Part No.	Descr.	Prod. No.	⊖	🌀	L	C
			"	"		
G45590-0605	6ACA-5FTON* **	7332-00635	5/16	1/2-20	2.81	1.56
G45590-0606	6ACA-6FTON	7332-00645	5/16	5/8-18	2.88	1.63
G45590-0608	6ACA-8FTON	7332-00655	5/16	3/4-16	3.00	1.75
G45590-0806	8ACA-6FTON	7332-03165	13/32	5/8-18	3.00	1.75
G45590-0808	8ACA-8FTON	7332-00665	13/32	3/4-16	3.00	1.75
G45590-1008	10ACA-8FTON	7332-01505	1/2	3/4-16	3.19	1.94
G45590-1010	10ACA-10FTON	7332-00675	1/2	7/8-14	3.19	1.94
G45590-1012	10ACA-12FTON	7332-01515	1/2	1 1/16-14	3.31	2.06
G45590-1210	12ACA-10FTON	7332-00685	5/8	7/8-14	3.31	2.06
G45590-1212	12ACA-12FTON	7332-00695	5/8	1 1/16-14	3.31	2.06

\*Standard and Metric threads are equivalent for 6ACA-5FTON.

\*\*Used on Toyota Receivers and Dryers.

## Female SAE Tube O-Ring Nut Swivel - Steel

O-Ring not included. Must be ordered separately.

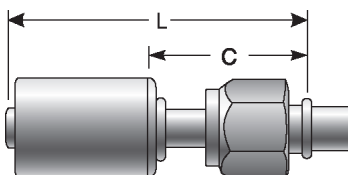

Part No.	Descr.	Prod. No.	⊖	🌀	L	C
			"	"		
G45590-0606S	6ACA-6FTON-S	7332-01275	5/16	5/8-18	2.88	1.63
G45590-0808S	8ACA-8FTON-S	7332-01645	13/32	3/4-16	3.00	1.75
G45590-1010S	10ACA-10FTON-S	7332-01655	1/2	7/8-14	3.19	1.94
G45590-1210S	12ACA-10FTON-S	7332-01815	5/8	7/8-14	3.31	2.06
G45590-1212S	12ACA-12FTON-S	7332-03175	5/8	1 1/16-14	3.31	2.06

EQUIPMENT
HOSE/CPLG. SELECTION
G8K COUPLINGS
GLOBALSPIRAL COUPLINGS
STAINLESS STEEL SPIRAL
MEGACRIMP COUPLINGS
STAINLESS STEEL BRAID
POWER CRIMP COUPLINGS
FIELD ATTACHABLE G1 & G2 COUPLINGS
FIELD ATTACHABLE C5 COUPLINGS
C14 COUPLINGS
GL COUPLINGS
GLX COUPLINGS
PCTS THERMOPLASTIC COUPLINGS
POLARSEAL COUPLINGS (ACA)
POLARSEAL II COUPLINGS (ACC)
POLARSEAL II COUPLINGS (ACB)
POWER STEERING
ADAPTERS
QUICK DISCONNECT COUPLERS
BALL VALVES
LIVE SWIVEL
ASSEMBLY FABRICATION
ACCESSORIES
EQUIPMENT AND PARTS
KITS
AIR BRAKE HOSE ASSY
BRASS



EQUIPMENT
HOSE/CPLG. SELECTION
G8K COUPLINGS
GLOBALSPIRAL COUPLINGS
STAINLESS STEEL SPIRAL
MEGACRIMP COUPLINGS
STAINLESS STEEL BRAID
POWER CRIMP COUPLINGS
FIELD ATTACHABLE G1 & G2 COUPLINGS
FIELD ATTACHABLE C5 COUPLINGS
C14 COUPLINGS
GL COUPLINGS
GLX COUPLINGS
PCTS THERMOPLASTIC COUPLINGS
<b>POLARSEAL COUPLINGS (ACA)</b>
POLARSEAL II COUPLINGS (ACC)
POLARSEAL II COUPLINGS (ACB)
POWER STEERING
ADAPTERS
QUICK DISCONNECT COUPLERS
BALL VALVES
LIVE SWIVEL
ASSEMBLY FABRICATION
ACCESSORIES
EQUIPMENT AND PARTS
KITS
AIR BRAKE HOSE ASSY
BRASS

## Female SAE Tube O-Ring Nut Swivel - 45° Bent Tube - Aluminum

O-Ring not included. Must be ordered separately.

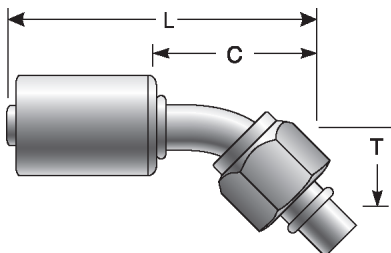

Part No.	Descr.	Prod. No.	⊖	🌀	T	L	C
			"	"	"	"	"
G45591-0606	6ACA-6FTON45	7332-00705	5/16	5/8-18	.56	2.87	1.52
G45591-0806	8ACA-6FTON45	7332-03185	13/32	5/8-18	.63	3.04	1.79
G45591-0808	8ACA-8FTON45	7332-00715	13/32	3/4-16	.63	3.07	1.82
G45591-1008	10ACA-8FTON45	7332-03195	1/2	3/4-16	.88	3.60	2.35
G45591-1010	10ACA-10FTON45	7332-00725	1/2	7/8-14	.88	3.63	2.38
G45591-1210	12ACA-10FTON45	7332-03205	5/8	7/8-14	.94	3.91	2.66
G45591-1212	12ACA-12FTON45	7332-00735	5/8	1 1/16-14	.94	3.94	2.69

## Female SAE Tube O-Ring Nut Swivel - 45° Bent Tube - Steel

O-Ring not included. Must be ordered separately.

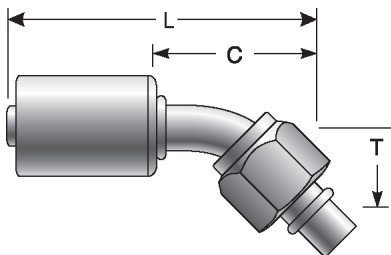

Part No.	Descr.	Prod. No.	⊖	🌀	T	L	C
			"	"	"	"	"
G45591-0606S	6ACA-6FTON45-S	7332-01665	5/16	5/8-18	.56	2.87	1.52
G45591-0808S	8ACA-8FTON45-S	7332-02055	13/32	3/4-16	.63	3.07	1.82
G45591-1010S	10ACA-10FTON45-S	7332-01675	1/2	7/8-14	.88	3.63	2.38



## Female SAE Tube O-Ring Nut Swivel - 90° Bent Tube - Aluminum

O-Ring not included. Must be ordered separately.

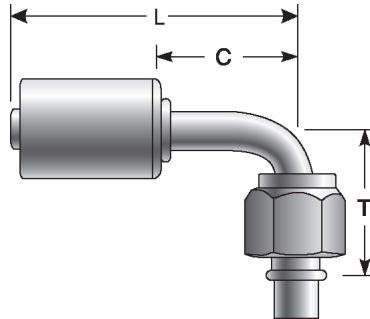

Part No.	Descr.	Prod. No.			T	L	C
			"	"			
G45592-0605	6ACA-5FTON90*	7332-00745	5/16	1/2-20	1.12	2.75	1.63
G45592-0606	6ACA-6FTON90	7332-00755	5/16	5/8-18	1.12	2.56	1.31
G45592-0608	6ACA-8FTON90	7332-00765	5/16	3/4-16	1.31	2.75	1.50
G45592-0806	8ACA-6FTON90	7332-03155	13/32	5/8-18	1.31	2.75	1.50
G45592-0808	8ACA-8FTON90	7332-00775	13/32	3/4-16	1.31	2.75	1.50
G45592-1008	10ACA-8FTON90	7332-01545	1/2	3/4-16	1.50	3.00	1.75
G45592-1010	10ACA-10FTON90	7332-00785	1/2	7/8-14	1.50	3.00	1.75
G45592-1012	10ACA-12FTON90	7332-01555	1/2	1 1/16-14	1.75	3.25	2.00
G45592-1210	12ACA-10FTON90	7332-00795	5/8	7/8-14	1.75	3.25	2.00
G45592-1212	12ACA-12FTON90	7332-00805	5/8	1 1/16-14	1.75	3.25	2.00

\*Used on Toyota Receivers and Dryers.

## Female SAE Tube O-Ring Nut Swivel - 90° Bent Tube - Steel

O-Ring not included. Must be ordered separately.

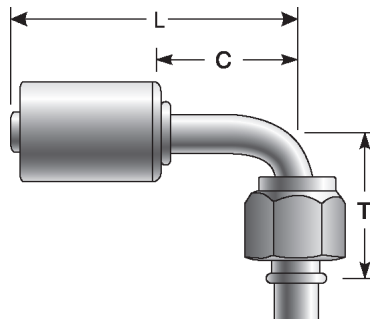

Part No.	Descr.	Prod. No.			T	L	C
			"	"			
G45592-0606S	6ACA-6FTON90-S	7332-01305	5/16	5/8-18	1.12	2.56	1.31
G45592-0808S	8ACA-8FTON90-S	7332-01685	13/32	3/4-16	1.31	2.75	1.50
G45592-1010S	10ACA-10FTON90-S	7332-01695	1/2	7/8-14	1.50	3.00	1.75
G45592-1210S	12ACA-10FTON90-S	7332-01825	5/8	7/8-14	1.50	3.25	2.00

EQUIPMENT
HOSE/CPLG. SELECTION
G8K COUPLINGS
GLOBALSPIRAL COUPLINGS
STAINLESS STEEL SPIRAL
MEGACRIMP COUPLINGS
STAINLESS STEEL BRAID
POWER CRIMP COUPLINGS
FIELD ATTACHABLE G1 & G2 COUPLINGS
FIELD ATTACHABLE C5 COUPLINGS
C14 COUPLINGS
GL COUPLINGS
GLX COUPLINGS
PCTS THERMOPLASTIC COUPLINGS
<b>POLARSEAL COUPLINGS (ACA)</b>
POLARSEAL II COUPLINGS (ACC)
POLARSEAL II COUPLINGS (ACB)
POWER STEERING
ADAPTERS
QUICK DISCONNECT COUPLERS
BALL VALVES
LIVE SWIVEL
ASSEMBLY FABRICATION
ACCESSORIES
EQUIPMENT AND PARTS
KITS
AIR BRAKE HOSE ASSY
BRASS

## Female SAE Tube O-Ring Metric Nut Swivel - Aluminum

O-Ring not included. Must be ordered separately.

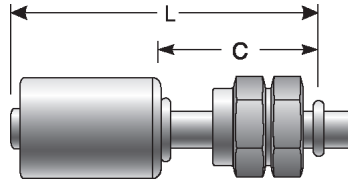

Part No.	Descr.	Prod. No.			L	C
			"	"		
G45593-0616	6ACA-16FTOMN	7332-00815	5/16	M16X1.5	2.81	1.56
G45593-0618	6ACA-18FTOMN	7332-03215	5/16	M18X1.5	2.87	1.62
G45593-0620	6ACA-20FTOMN	7332-03225	5/16	M20X1.5	2.94	1.69
G45593-0820	8ACA-20FTOMN	7332-03235	13/32	M20X1.5	2.94	1.69
G45593-1022	10ACA-22FTOMN	7332-00825	1/2	M22X1.5	3.19	1.94
G45593-1024	10ACA-24FTOMN	7332-00835	1/2	M24X2.0	3.19	1.94
G45593-1227	12ACA-27FTOMN	7332-00845	5/8	M27X2.0	3.31	2.06

## Female SAE Tube O-Ring Metric Nut Swivel - 45° Bent Tube - Aluminum

O-Ring not included. Must be ordered separately.

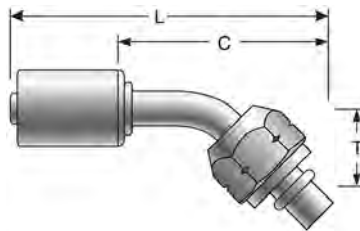

Part No.	Descr.	Prod. No.			T	L	C
			"	"			
G45594-0614	6ACA-14FTOMN45	7332-03245	5/16	M14X1.5	.63	3.47	2.22
G45594-0616	6ACA-16FTOMN45	7332-03255	5/16	M16X1.5	.63	3.47	2.22
G45594-0618	6ACA-18FTOMN45	7332-03265	5/16	M18X1.5	.69	3.53	2.28
G45594-0620	6ACA-20FTOMN45	7332-03275	5/16	M20X1.5	.75	3.72	2.47
G45594-0820	8ACA-20FTOMN45	7332-03285	13/32	M20X1.5	.75	3.72	2.47
G45594-1022	10ACA-22FTOMN45	7332-03295	1/2	M22X1.5	.88	3.60	2.35
G45594-1024	10ACA-24FTOMN45	7332-03305	1/2	M24X2.0	.88	3.60	2.35
G45594-1227	12ACA-27FTOMN45	7332-03315	5/8	M27X2.0	1.00	4.59	3.34

EQUIPMENT
HOSE/CPLG. SELECTION
G8K COUPLINGS
GLOBAL SPIRAL COUPLINGS
STAINLESS STEEL SPIRAL
MEGACRIMP COUPLINGS
STAINLESS STEEL BRAID
POWER CRIMP COUPLINGS
FIELD ATTACHABLE G1 & G2 COUPLINGS
FIELD ATTACHABLE C5 COUPLINGS
C14 COUPLINGS
GL COUPLINGS
GLX COUPLINGS
PCTS THERMOPLASTIC COUPLINGS
POLARSEAL COUPLINGS (ACA)
POLARSEAL II COUPLINGS (ACC)
POLARSEAL II COUPLINGS (ACB)
POWER STEERING
ADAPTERS
QUICK DISCONNECT COUPLERS
BALL VALVES
LIVE SWIVEL
ASSEMBLY FABRICATION
ACCESSORIES
EQUIPMENT AND PARTS
KITS
AIR BRAKE HOSE ASSY
BRASS





## Female SAE Tube O-Ring Metric Nut Swivel - 90° Bent Tube - Aluminum

O-Ring not included. Must be ordered separately.

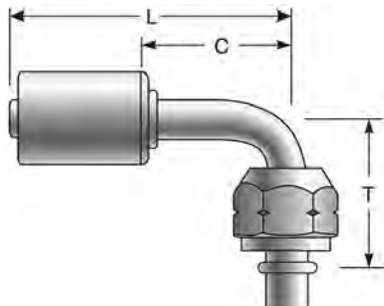

Part No.	Descr.	Prod. No.	⊖	🌀	T	L	C
			"	"	"	"	"
G45595-0616	6ACA-16FTOMN90	7332-00855	5/16	M16X1.5	1.12	2.75	1.50
G45595-0618	6ACA-18FTOMN90	7332-03325	5/16	M18X1.5	1.12	2.75	1.50
G45595-0620	6ACA-20FTOMN90	7332-03335	5/16	M20X1.5	1.25	2.75	1.50
G45595-0820	8ACA-20FTOMN90	7332-03345	13/32	M20X1.5	1.37	2.94	1.69
G45595-1022	10ACA-22FTOMN90	7332-00865	1/2	M22X1.5	1.63	3.13	1.88
G45595-1024	10ACA-24FTOMN90	7332-00875	1/2	M24X2.0	1.50	3.13	1.88
G45595-1227	12ACA-27FTOMN90	7332-00885	5/8	M27X2.0	1.75	3.38	2.13

## Female SAE Tube O-Ring Nut Swivel - 90° Block - Steel

O-Ring not included. Must be ordered separately.

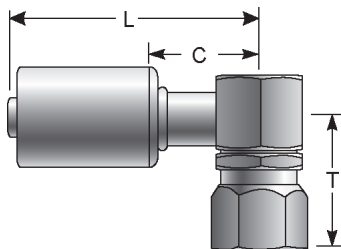

Part No.	Descr.	Prod. No.	⊖	🌀	T	L	C
			"	"	"	"	"
G45596-0808S	8ACA-8FTON90BL-S	7332-01835	13/32	3/4-16	.71	2.44	1.19
G45596-1010S	10ACA-10FTON90BL-S	7332-01845	1/2	7/8-14	.71	2.50	1.25
G45596-1210S	12ACA-10FTON90BL-S	7332-01855	5/8	7/8-14	.71	2.62	1.37

- EQUIPMENT
- HOSE/CPLG. SELECTION
- G8K COUPLINGS
- GLOBALSPIRAL COUPLINGS
- STAINLESS STEEL SPIRAL
- MEGACRIMP COUPLINGS
- STAINLESS STEEL BRAID
- POWER CRIMP COUPLINGS
- FIELD ATTACHABLE G1 & G2 COUPLINGS
- FIELD ATTACHABLE C5 COUPLINGS
- C14 COUPLINGS
- GL COUPLINGS
- GLX COUPLINGS
- PCTS THERMOPLASTIC COUPLINGS
- POLARSEAL COUPLINGS (ACA)**
- POLARSEAL II COUPLINGS (ACC)
- POLARSEAL II COUPLINGS (ACB)
- POWER STEERING
- ADAPTERS
- QUICK DISCONNECT COUPLERS
- BALL VALVES
- LIVE SWIVEL
- ASSEMBLY FABRICATION
- ACCESSORIES
- EQUIPMENT AND PARTS
- KITS
- AIR BRAKE HOSE ASSY
- BRASS



EQUIPMENT
HOSE/CPLG. SELECTION
G8K COUPLINGS
GLOBAL SPIRAL COUPLINGS
STAINLESS STEEL SPIRAL
MEGACRIMP COUPLINGS
STAINLESS STEEL BRAID
POWER CRIMP COUPLINGS
FIELD ATTACHABLE G1 & G2 COUPLINGS
FIELD ATTACHABLE C5 COUPLINGS
C14 COUPLINGS
GL COUPLINGS
GLX COUPLINGS
PCTS THERMOPLASTIC COUPLINGS
POLARSEAL COUPLINGS (ACA)
POLARSEAL II COUPLINGS (ACC)
POLARSEAL II COUPLINGS (ACB)
POWER STEERING
ADAPTERS
QUICK DISCONNECT COUPLERS
BALL VALVES
LIVE SWIVEL
ASSEMBLY FABRICATION
ACCESSORIES
EQUIPMENT AND PARTS
KITS
AIR BRAKE HOSE ASSY
BRASS

### Male Inverted O-Ring - Aluminum

O-Ring not included. Must be ordered separately.

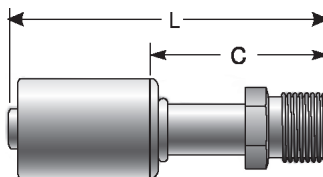

Part No.	Descr.	Prod. No.	⊖		L	C
			"	"		
G45597-0606	6ACA-6MIO	7332-00895	5/16	5/8-18	2.94	1.69
G45597-0808	8ACA-8MIO	7332-00905	13/32	3/4-18	3.13	1.88
G45597-1010	10ACA-10MIO	7332-00915	1/2	7/8-14	3.62	2.37
G45597-1212	12ACA-12MIO	7332-00925	5/8	1 1/16-14	3.88	2.63

### Male Inverted O-Ring - Steel

O-Ring not included. Must be ordered separately.

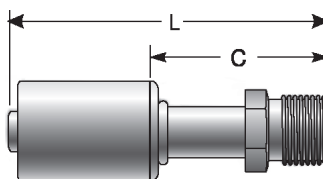

Part No.	Descr.	Prod. No.	⊖		L	C
			"	"		
G45597-0606S	6ACA-6MIO-S	7332-01885	5/16	5/8-18	2.94	1.69
G45597-0808S	8ACA-8MIO-S	7332-01895	13/32	3/4-18	3.13	1.88
G45597-1010S	10ACA-10MIO-S	7332-03355	1/2	7/8-14	3.62	2.37

### Male Inverted O-Ring - 45° Bent Tube - Aluminum

O-Ring not included. Must be ordered separately.

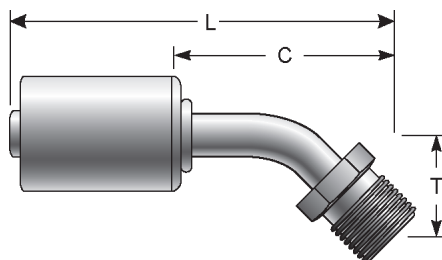

Part No.	Descr.	Prod. No.	⊖		T	L	C
			"	"	"		
G45598-0606	6ACA-6MIO45	7332-03365	5/16	5/8-18	.75	3.03	1.78
G45598-0808	8ACA-8MIO45	7332-03375	13/32	3/4-18	1.00	3.41	2.16
G45598-1010	10ACA-10MIO45	7332-03385	1/2	7/8-14	1.25	3.97	2.72



### Male Inverted O-Ring - 90° Bent Tube - Aluminum

O-Ring not included. Must be ordered separately.

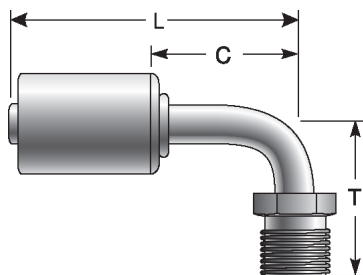

Part No.	Descr.	Prod. No.			T	L	C
			"	"			
G45599-0606	6ACA-6MIO90	7332-00935	5/16	5/8-18	1.50	2.56	1.31
G45599-0808	8ACA-8MIO90	7332-00945	13/32	3/4-18	1.75	2.75	1.50
G45599-1010	10ACA-10MIO90	7332-00955	1/2	7/8-14	2.00	3.00	1.75

### Male Inverted O-Ring Bulkhead - Aluminum

O-Ring not included. Must be ordered separately.

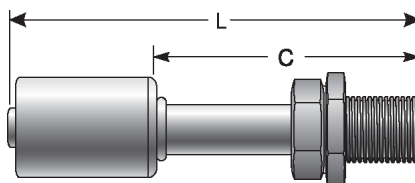

Part No.	Descr.	Prod. No.			L	C
			"	"		
G45600-0606	6ACA-6MIOBKHD	7332-00965	5/16	5/8-18	4.00	2.75
G45600-0808	8ACA-8MIOBKHD	7332-00975	13/32	3/4-18	4.25	3.00
G45600-1010	10ACA-10MIOBKHD	7332-00985	1/2	7/8-14	4.44	3.19

### Male Inverted O-Ring Bulkhead - Steel

O-Ring not included. Must be ordered separately.

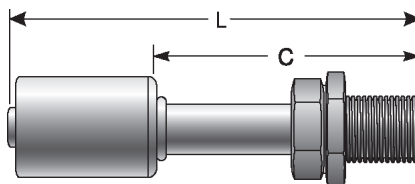

Part No.	Descr.	Prod. No.			L	C
			"	"		
G45600-0606S	6ACA-6MIOBKHD-S	7332-04445	5/16	5/8-18	1.82	2.36
G45600-1010S	10ACA-10MIOBKHD-S	7332-04455	1/2	7/8-14	2.13	2.57

EQUIPMENT
HOSE/CPLG. SELECTION
G8K COUPLINGS
GLOBALSPIRAL COUPLINGS
STAINLESS STEEL SPIRAL
MEGACRIMP COUPLINGS
STAINLESS STEEL BRAID
POWER CRIMP COUPLINGS
FIELD ATTACHABLE G1 & G2 COUPLINGS
FIELD ATTACHABLE C5 COUPLINGS
C14 COUPLINGS
GL COUPLINGS
GLX COUPLINGS
PCTS THERMOPLASTIC COUPLINGS
<b>POLARSEAL COUPLINGS (ACA)</b>
POLARSEAL II COUPLINGS (ACC)
POLARSEAL II COUPLINGS (ACB)
POWER STEERING
ADAPTERS
QUICK DISCONNECT COUPLERS
BALL VALVES
LIVE SWIVEL
ASSEMBLY FABRICATION
ACCESSORIES
EQUIPMENT AND PARTS
KITS
AIR BRAKE HOSE ASSY
BRASS



EQUIPMENT
HOSE/CPLG. SELECTION
G8K COUPLINGS
GLOBAL SPIRAL COUPLINGS
STAINLESS STEEL SPIRAL
MEGACRIMP COUPLINGS
STAINLESS STEEL BRAID
POWER CRIMP COUPLINGS
FIELD ATTACHABLE G1 & G2 COUPLINGS
FIELD ATTACHABLE C5 COUPLINGS
C14 COUPLINGS
GL COUPLINGS
GLX COUPLINGS
PCTS THERMOPLASTIC COUPLINGS
<b>POLARSEAL COUPLINGS (ACA)</b>
POLARSEAL II COUPLINGS (ACC)
POLARSEAL II COUPLINGS (ACB)
POWER STEERING
ADAPTERS
QUICK DISCONNECT COUPLERS
BALL VALVES
LIVE SWIVEL
ASSEMBLY FABRICATION
ACCESSORIES
EQUIPMENT AND PARTS
KITS
AIR BRAKE HOSE ASSY
BRASS

## Male Inverted O-Ring Bulkhead - 90° Bent Tube - Aluminum

O-Ring not included. Must be ordered separately.

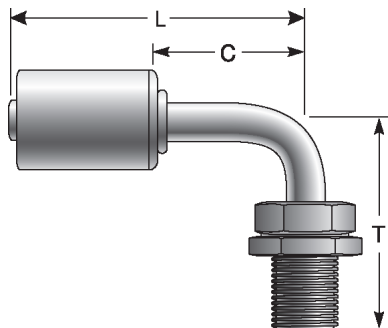

Part No.	Descr.	Prod. No.	⊖		T	L	C
			"	"	"	"	"
G45602-0606	6ACA-6MIOBKHD90	7332-00995	5/16	5/8-18	2.12	3.13	1.88
G45602-0808	8ACA-8MIOBKHD90	7332-01005	13/32	3/4-18	2.44	3.25	2.00
G45602-1010	10ACA-10MIOBKHD90	7332-01015	1/2	7/8-14	2.50	3.50	2.25

## Female SAE Tube Dual O-Ring Nut - Aluminum

O-Ring not included. Must be ordered separately.

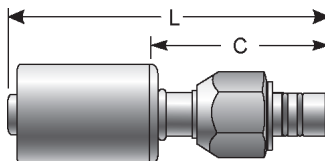

Part No.	Descr.	Prod. No.	⊖		L	C
			"	"	"	"
G45604-0808	8ACA-8FTDON	7332-03395	13/32	13/16-16	3.55	2.30
G45604-1010	10ACA-10FTDON	7332-03405	1/2	15/16-16	3.79	2.54
G45604-1212	12ACA-12FTDON	7332-03415	5/8	1 1/16-14	3.96	2.71



### Female SAE Tube Dual O-Ring Nut - 45° Bent Tube - Aluminum

O-Ring not included. Must be ordered separately.

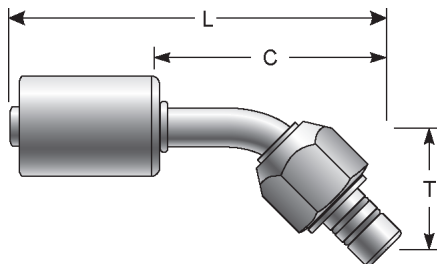

Part No.	Descr.	Prod. No.	⊖		T	L	C
			"	"	"	"	"
G45605-0808	8ACA-8FTDON45	7332-03425	13/32	13/16-16	1.02	3.43	2.18
G45605-1212	12ACA-12FTDON45	7332-03445	5/8	1 1/16-14	1.40	4.37	3.12

### Female SAE Tube Dual O-Ring Nut - 90° Bent Tube - Aluminum

O-Ring not included. Must be ordered separately.

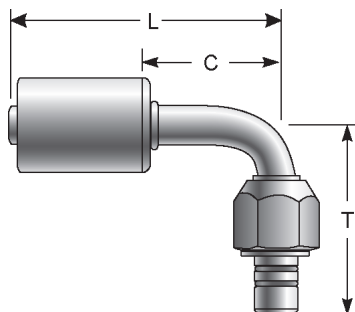

Part No.	Descr.	Prod. No.	⊖		T	L	C
			"	"	"	"	"
G45606-0808	8ACA-8FTDON90	7332-03455	13/32	13/16-16	1.86	2.75	1.50
G45606-1010	10ACA-10FTDON90	7332-03465	1/2	15/16-16	1.91	3.00	1.75
G45606-1212	12ACA-12FTDON90	7332-03475	5/8	1 1/16-14	2.40	3.25	2.00

### Female SAE Tube Dual O-Ring Metric Nut - Aluminum

O-Ring not included. Must be ordered separately.

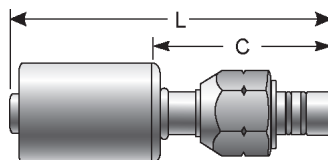

Part No.	Descr.	Prod. No.	⊖		L	C
			"	"	"	"
G45607-0824	8ACA-24FTDOMN	7332-03485	13/32	M24X2.0	3.55	2.30

EQUIPMENT
HOSE/CPLG. SELECTION
G8K COUPLINGS
GLOBALSPIRAL COUPLINGS
STAINLESS STEEL SPIRAL
MEGACRIMP COUPLINGS
STAINLESS STEEL BRAID
POWER CRIMP COUPLINGS
FIELD ATTACHABLE G1 & G2 COUPLINGS
FIELD ATTACHABLE C5 COUPLINGS
C14 COUPLINGS
GL COUPLINGS
GLX COUPLINGS
PCTS THERMOPLASTIC COUPLINGS
<b>POLARSEAL COUPLINGS (ACA)</b>
POLARSEAL II COUPLINGS (ACC)
POLARSEAL II COUPLINGS (ACB)
POWER STEERING
ADAPTERS
QUICK DISCONNECT COUPLERS
BALL VALVES
LIVE SWIVEL
ASSEMBLY FABRICATION
ACCESSORIES
EQUIPMENT AND PARTS
KITS
AIR BRAKE HOSE ASSY
BRASS



EQUIPMENT
HOSE/CPLG. SELECTION
G8K COUPLINGS
GLOBAL SPIRAL COUPLINGS
STAINLESS STEEL SPIRAL
MEGACRIMP COUPLINGS
STAINLESS STEEL BRAID
POWER CRIMP COUPLINGS
FIELD ATTACHABLE G1 & G2 COUPLINGS
FIELD ATTACHABLE C5 COUPLINGS
C14 COUPLINGS
GL COUPLINGS
GLX COUPLINGS
PCTS THERMOPLASTIC COUPLINGS
<b>POLARSEAL COUPLINGS (ACA)</b>
POLARSEAL II COUPLINGS (ACC)
POLARSEAL II COUPLINGS (ACB)
POWER STEERING
ADAPTERS
QUICK DISCONNECT COUPLERS
BALL VALVES
LIVE SWIVEL
ASSEMBLY FABRICATION
ACCESSORIES
EQUIPMENT AND PARTS
KITS
AIR BRAKE HOSE ASSY
BRASS

### Female SAE Tube Dual O-Ring Metric Nut - Aluminum - Continued

Part No.	Descr.	Prod. No.	⊖		L	C
			"	"		
G45607-1024	10ACA-24FTDOMN	7332-03495	1/2	M24X2.0	3.79	2.54
G45607-1227	12ACA-27FTDOMN	7332-03505	5/8	M27X2.0	3.96	2.71

### Female SAE Tube Dual O-Ring Metric Nut - 45° Bent Tube - Aluminum

O-Ring not included. Must be ordered separately.

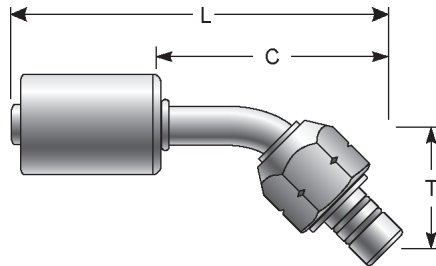

Part No.	Descr.	Prod. No.	⊖		T	L	C
			"	"			
G45608-0824	8ACA-24FTDOMN45	7332-03515	13/32	M24X2.0	1.02	3.43	2.18
G45608-1024	10ACA-24FTDOMN45	7332-03525	1/2	M24X2.0	1.30	4.02	2.77
G45608-1227	12ACA-27FTDOMN45	7332-03535	5/8	M27X2.0	1.40	4.37	3.12

### Female SAE Tube Dual O-Ring Metric Nut - 90° Bent Tube - Aluminum

O-Ring not included. Must be ordered separately.

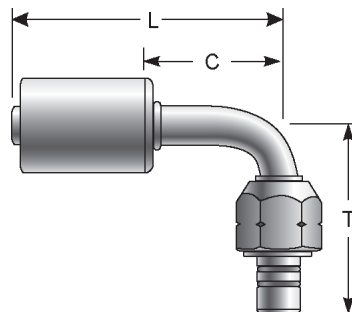

Part No.	Descr.	Prod. No.	⊖		T	L	C
			"	"			
G45609-0824	8ACA-24FTDOMN90	7332-03545	13/32	M24X2.0	1.86	2.75	1.50
G45609-1024	10ACA-24FTDOMN90	7332-03555	1/2	M24X2.0	1.91	3.00	1.75
G45609-1227	12ACA-27FTDOMN90	7332-03565	5/8	M27X2.0	2.40	3.25	2.00



## Female SAE Tube O-Ring Nut - 180° Bent Tube - Aluminum

O-Ring not included. Must be ordered separately.

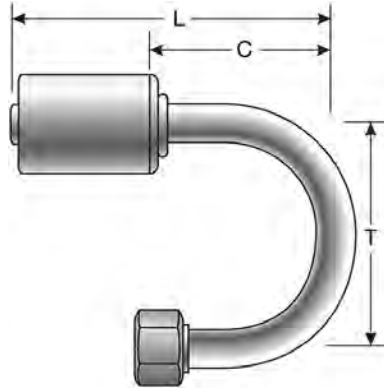

Part No.	Descr.	Prod. No.			T	L	C
			"	"			
G45610-0606	6ACA-6FTON180	7332-03575	5/16	5/8-18	1.63	3.50	2.25
G45610-0808	8ACA-8FTON180	7332-03585	13/32	3/4-16	1.75	3.50	2.25
G45610-1212	12ACA-12FTON180	7332-03595	5/8	1 1/16-14	2.12	4.50	3.25

## Male Inverted O-Ring with R134a Service Port - Aluminum

O-Ring not included. Must be ordered separately.

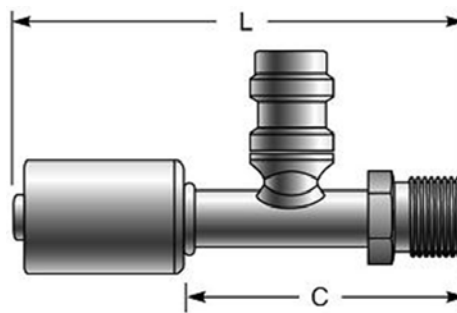

Part No.	Descr.	Prod. No.			L	C
			"	"		
G45611-0606	6ACA-6MIO134SP	7332-03605	5/16	5/8-18	3.47	2.22
G45611-0808	8ACA-8MIO134SP	7332-03615	13/32	3/4-18	4.22	2.97
G45611-1010	10ACA-10MIO134SP	7332-03625	1/2	7/8-14	4.22	2.97
G45611-1212	12ACA-12MIO134SP	7332-03635	5/8	1 1/16-14	4.47	3.22

EQUIPMENT
HOSE/CPLG. SELECTION
G8K COUPLINGS
GLOBALSPIRAL COUPLINGS
STAINLESS STEEL SPIRAL
MEGACRIMP COUPLINGS
STAINLESS STEEL BRAID
POWER CRIMP COUPLINGS
FIELD ATTACHABLE G1 & G2 COUPLINGS
FIELD ATTACHABLE C5 COUPLINGS
C14 COUPLINGS
GL COUPLINGS
GLX COUPLINGS
PCTS THERMOPLASTIC COUPLINGS
<b>POLARSEAL COUPLINGS (ACA)</b>
POLARSEAL II COUPLINGS (ACC)
POLARSEAL II COUPLINGS (ACB)
POWER STEERING
ADAPTERS
QUICK DISCONNECT COUPLERS
BALL VALVES
LIVE SWIVEL
ASSEMBLY FABRICATION
ACCESSORIES
EQUIPMENT AND PARTS
KITS
AIR BRAKE HOSE ASSY
BRASS





EQUIPMENT
HOSE/CPLG. SELECTION
G8K COUPLINGS
GLOBAL SPIRAL COUPLINGS
STAINLESS STEEL SPIRAL
MEGACRIMP COUPLINGS
STAINLESS STEEL BRAID
POWER CRIMP COUPLINGS
FIELD ATTACHABLE G1 & G2 COUPLINGS
FIELD ATTACHABLE C5 COUPLINGS
C14 COUPLINGS
GL COUPLINGS
GLX COUPLINGS
PCTS THERMOPLASTIC COUPLINGS
<b>POLARSEAL COUPLINGS (ACA)</b>
POLARSEAL II COUPLINGS (ACC)
POLARSEAL II COUPLINGS (ACB)
POWER STEERING
ADAPTERS
QUICK DISCONNECT COUPLERS
BALL VALVES
LIVE SWIVEL
ASSEMBLY FABRICATION
ACCESSORIES
EQUIPMENT AND PARTS
KITS
AIR BRAKE HOSE ASSY
BRASS

## Male Inverted O-Ring with R134a Service Port - 90° Bent Tube - Aluminum

O-Ring not included. Must be ordered separately.

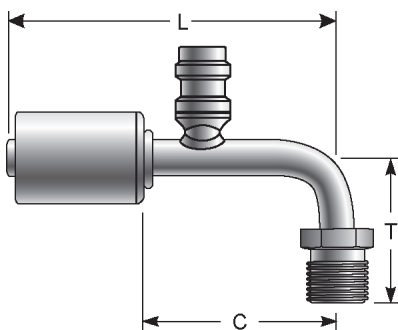

Part No.	Descr.	Prod. No.	⊖	🌀	T	L	C
			"	"			
G45613-0606	6ACA-6MIO134SP90	7332-03645	5/16	5/8-18	1.50	3.59	2.34
G45613-0808	8ACA-8MIO134SP90	7332-03655	13/32	3/4-18	1.80	3.59	2.34
G45613-1010	10ACA-10MIO134SP90	7332-03665	1/2	7/8-14	2.00	3.85	2.60

## Universal Tee O-Ring Splicer English Threads - Aluminum

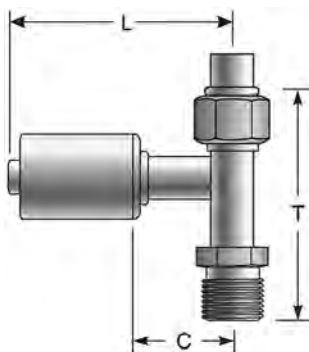

Part No.	Descr.	Prod. No.	⊖	🌀	T	L	C
			"	"			
G45614-0606	6ACA-6TORSP	7332-03675	5/16	5/8-18	2.47	2.50	1.25
G45614-0608	6ACA-8TORSP	7332-03685	5/16	3/4-16	2.97	2.62	1.37
G45614-1010	10ACA-10TORSP	7332-03695	1/2	7/8-14	3.53	2.75	1.50
G45614-1012	10ACA-12TORSP	7332-03705	1/2	1 1/16-14	4.10	2.94	1.69



## Female SAE Tube O-Ring Nut Swivel with R134a High Pressure Service Port - Aluminum

O-Ring not included. Must be ordered separately.

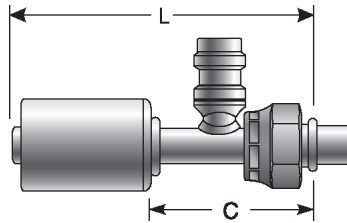

Part No.	Descr.	Prod. No.	⊖	🌀	L	C
			"	"	"	"
G45688-1010	10ACA-10FTON134SPH	7332-04245	1/2	7/8-14	3.62	2.37

## Male Metric Flareless Assembly - Aluminum

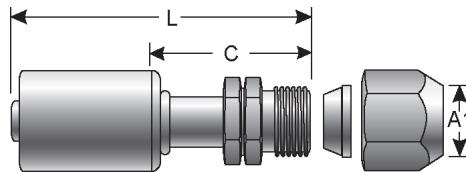

Part No.	Descr.	Prod. No.	⊖	🌀	A1	L	C
			"	"	mm	"	"
G45935-0608	6ACA-8MMFA	7332-01025	5/16	5/8-18	8.0	2.77	1.52
G45935-0812	8ACA-12MMFA	7332-01035	13/32	3/4-16	12.0	3.00	1.75
G45935-1015	10ACA-14.5MMFA	7332-01045	1/2	7/8-14	14.5	3.12	1.87

## Female (Ford) Spring Lock Tee O-Ring Splicer - Aluminum

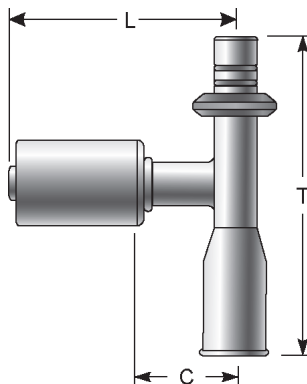

Part No.	Descr.	Prod. No.	⊖	T	L	C
			"	"	"	"
G45947-0608	6ACA-8FSLTORSP	7332-03735	5/16	1.72	5.13	3.88

EQUIPMENT
HOSE/CPLG. SELECTION
G8K COUPLINGS
GLOBALSPIRAL COUPLINGS
STAINLESS STEEL SPIRAL
MEGACRIMP COUPLINGS
STAINLESS STEEL BRAID
POWER CRIMP COUPLINGS
FIELD ATTACHABLE G1 & G2 COUPLINGS
FIELD ATTACHABLE C5 COUPLINGS
C14 COUPLINGS
GL COUPLINGS
GLX COUPLINGS
PCTS THERMOPLASTIC COUPLINGS
POLARSEAL COUPLINGS (ACA)
POLARSEAL II COUPLINGS (ACC)
POLARSEAL II COUPLINGS (ACB)
POWER STEERING
ADAPTERS
QUICK DISCONNECT COUPLERS
BALL VALVES
LIVE SWIVEL
ASSEMBLY FABRICATION
ACCESSORIES
EQUIPMENT AND PARTS
KITS
AIR BRAKE HOSE ASSY
BRASS



EQUIPMENT
HOSE/CPLG. SELECTION
G8K COUPLINGS
GLOBAL SPIRAL COUPLINGS
STAINLESS STEEL SPIRAL
MEGACRIMP COUPLINGS
STAINLESS STEEL BRAID
POWER CRIMP COUPLINGS
FIELD ATTACHABLE G1 & G2 COUPLINGS
FIELD ATTACHABLE C5 COUPLINGS
C14 COUPLINGS
GL COUPLINGS
GLX COUPLINGS
PCTS THERMOPLASTIC COUPLINGS
<b>POLARSEAL COUPLINGS (ACA)</b>
POLARSEAL II COUPLINGS (ACC)
POLARSEAL II COUPLINGS (ACB)
POWER STEERING
ADAPTERS
QUICK DISCONNECT COUPLERS
BALL VALVES
LIVE SWIVEL
ASSEMBLY FABRICATION
ACCESSORIES
EQUIPMENT AND PARTS
KITS
AIR BRAKE HOSE ASSY
BRASS

### Female (Ford) Spring Lock Liquid Line Splicer - Aluminum

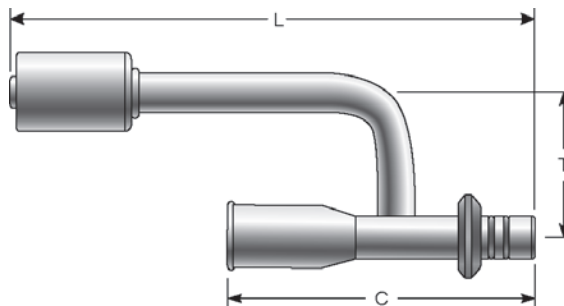

Part No.	Descr.	Prod. No.	⊖	T	L	C
			"	"	"	"
G45948-0608	6ACA-8FSLSP	7332-03715	5/16	1.75	5.13	3.88

### Male (Ford) Spring Lock - 45° Bent Tube - Aluminum

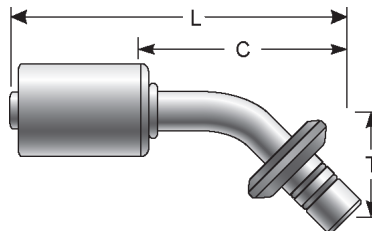

Part No.	Descr.	Prod. No.	⊖	T	L	C
			"	"	"	"
G45949-0606	6ACA-6MSL45	7332-03725	5/16	1.25	3.97	2.72
G45949-0608	6ACA-8MSL45	7332-03745	5/16	1.31	4.09	2.84
G45949-0808	8ACA-8MSL45	7332-03755	13/32	1.31	4.09	2.84
G45949-1010	10ACA-10MSL45	7332-03765	1/2	1.63	4.48	3.23
G45949-1210	12ACA-10MSL45	7332-03785	5/8	1.63	4.48	3.23
G45949-1212	12ACA-12MSL45	7332-03795	5/8	1.75	4.72	3.47

### Male (Ford) Spring Lock - Aluminum

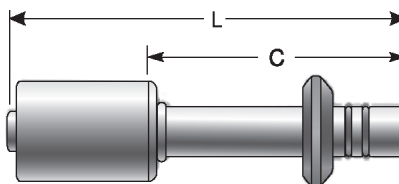

Part No.	Descr.	Prod. No.	⊖	L	C
			"	"	"
G45950-0606	6ACA-6MSL	7332-01055	5/16	3.81	2.56
G45950-0608	6ACA-8MSL	7332-01575	5/16	3.88	2.63



Male (Ford) Spring Lock - Aluminum - Continued

Part No.	Descr.	Prod. No.	⊖	L	C
			"		
G45950-0808	8ACA-8MSL	7332-01065	13/32	3.88	2.63
G45950-1010	10ACA-10MSL	7332-01075	1/2	4.00	2.75
G45950-1210	12ACA-10MSL	7332-01585	5/8	4.00	2.75
G45950-1212	12ACA-12MSL	7332-01085	5/8	4.25	3.00

Male (Ford) Spring Lock - 90° Bent Tube - Aluminum

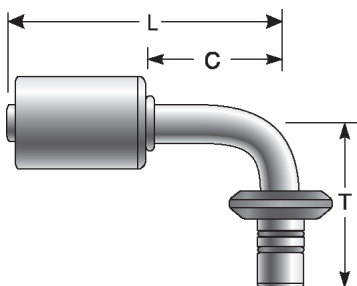

Part No.	Descr.	Prod. No.	⊖	T	L	C
			"			
G45951-0606	6ACA-6MSL90	7332-02135	5/16	2.19	2.88	1.63
G45951-0608	6ACA-8MSL90	7332-02185	5/16	2.38	3.12	1.88
G45951-0808	8ACA-8MSL90	7332-02145	13/32	2.38	2.94	1.69
G45951-1010	10ACA-10MSL90	7332-02155	1/2	2.50	1.95	1.89
G45951-1210	12ACA-10MSL90	7332-02175	5/8	2.50	3.13	1.89

Female (Ford) Spring Lock - Aluminum

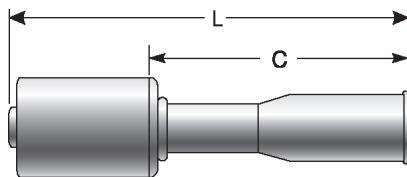

Part No.	Descr.	Prod. No.	⊖	L	C
			"		
G45952-0606	6ACA-6FSL	7332-01095	5/16	3.81	2.56
G45952-0608	6ACA-8FSL	7332-01595	5/16	3.85	2.59
G45952-0808	8ACA-8FSL	7332-01105	13/32	3.88	2.63
G45952-1010	10ACA-10FSL	7332-01115	1/2	4.13	2.88
G45952-1210	12ACA-10FSL	7332-01605	5/8	4.28	3.10
G45952-1212	12ACA-12FSL	7332-01125	5/8	4.25	3.00

- EQUIPMENT
- HOSE/CPLG. SELECTION
- G8K COUPLINGS
- GLOBAL SPIRAL COUPLINGS
- STAINLESS STEEL SPIRAL
- MEGACRIMP COUPLINGS
- STAINLESS STEEL BRAID
- POWER CRIMP COUPLINGS
- FIELD ATTACHABLE G1 & G2 COUPLINGS
- FIELD ATTACHABLE C5 COUPLINGS
- C14 COUPLINGS
- GL COUPLINGS
- GLX COUPLINGS
- PCTS THERMOPLASTIC COUPLINGS
- POLARSEAL COUPLINGS (ACA)**
- POLARSEAL II COUPLINGS (ACC)
- POLARSEAL II COUPLINGS (ACB)
- POWER STEERING
- ADAPTERS
- QUICK DISCONNECT COUPLERS
- BALL VALVES
- LIVE SWIVEL
- ASSEMBLY FABRICATION
- ACCESSORIES
- EQUIPMENT AND PARTS
- KITS
- AIR BRAKE HOSE ASSY
- BRASS



EQUIPMENT
HOSE/CPLG. SELECTION
G8K COUPLINGS
GLOBAL SPIRAL COUPLINGS
STAINLESS STEEL SPIRAL
MEGACRIMP COUPLINGS
STAINLESS STEEL BRAID
POWER CRIMP COUPLINGS
FIELD ATTACHABLE G1 & G2 COUPLINGS
FIELD ATTACHABLE C5 COUPLINGS
C14 COUPLINGS
GL COUPLINGS
GLX COUPLINGS
PCTS THERMOPLASTIC COUPLINGS
<b>POLARSEAL COUPLINGS (ACA)</b>
POLARSEAL II COUPLINGS (ACC)
POLARSEAL II COUPLINGS (ACB)
POWER STEERING
ADAPTERS
QUICK DISCONNECT COUPLERS
BALL VALVES
LIVE SWIVEL
ASSEMBLY FABRICATION
ACCESSORIES
EQUIPMENT AND PARTS
KITS
AIR BRAKE HOSE ASSY
BRASS

## Female (Ford) Spring Lock - 90° Bent Tube - Aluminum

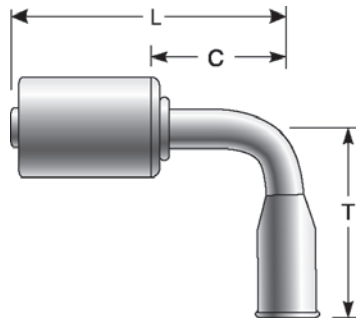

Part No.	Descr.	Prod. No.	⊖	T	L	C
			"	"	"	"
G45953-0606	6ACA-6FSL90	7332-02195	5/16	2.19	2.88	1.63
G45953-0608	6ACA-8FSL90	7332-02245	5/16	2.38	3.12	1.88
G45953-0808	8ACA-8FSL90	7332-02205	13/32	2.38	2.94	1.69
G45953-1010	10ACA-10FSL90	7332-02215	1/2	2.50	3.13	1.89
G45953-1210	12ACA-10FSL90	7332-02235	5/8	2.50	3.13	1.89
G45953-1212	12ACA-12FSL90	7332-02225	5/8	3.20	3.69	2.44

## Hose Splicer with R12 Thread Service Port - Aluminum

Service Ports: High Side; -6, -8 Hose; 3/8" Schrader Valve  
 Service Ports: Low Side; -10, -12 Hose; 1/4" Schrader Valve

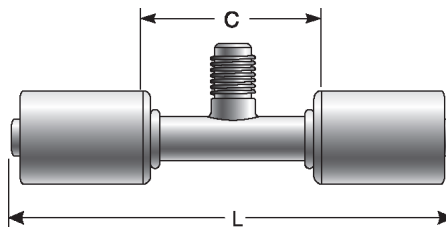

Part No.	Descr.	Prod. No.	⊖	L	C
			"	"	"
G45954-0606	6ACA-R12SP	7332-01135	5/16	4.50	2.00
G45954-0808	8ACA-R12SP	7332-01145	13/32	4.50	2.00
G45954-1010	10ACA-R12SP	7332-01155	1/2	4.63	2.13
G45954-1212	12ACA-R12SP	7332-01165	5/8	4.75	2.25



## Female (Ford) Spring Lock - 45° Bent Tube - Aluminum

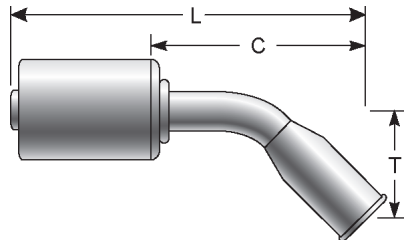

Part No.	Descr.	Prod. No.	⊖	T	L	C
			"	"	"	"
G45955-0606	6ACA-6FSL45	7332-03805	5/16	1.31	4.03	2.78
G45955-0608	6ACA-8FSL45	7332-03815	5/16	1.37	4.15	2.90
G45955-0808	8ACA-8FSL45	7332-03825	13/32	1.37	4.15	2.90
G45955-1010	10ACA-10FSL45	7332-03835	1/2	1.69	4.54	3.29
G45955-1210	12ACA-10FSL45	7332-03845	5/8	1.75	4.60	3.35
G45955-1212	12ACA-12FSL45	7332-03855	5/8	1.75	4.72	3.47

## Hose Splicer with R134a Service Port - Aluminum

Service Ports: High Side; -6, -8 Hose; 3/8" Schrader Valve  
 Service Ports: Low Side; -10, -12 Hose; 1/4" Schrader Valve

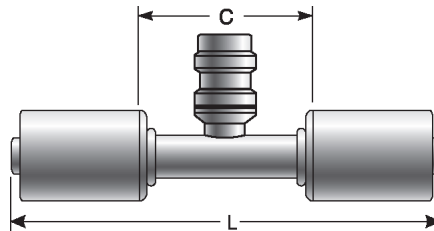

Part No.	Descr.	Prod. No.	⊖	L	C
			"	"	"
G45956-0606	6ACA-R134SP	7332-01175	5/16	4.50	2.00
G45956-0808	8ACA-R134SP	7332-01185	13/32	4.50	2.00
G45956-1010	10ACA-R134SP	7332-01195	1/2	4.63	2.13
G45956-1212	12ACA-R134SP	7332-01205	5/8	4.75	2.25

- EQUIPMENT
- HOSE/CPLG. SELECTION
- G8K COUPLINGS
- GLOBALSPIRAL COUPLINGS
- STAINLESS STEEL SPIRAL
- MEGACRIMP COUPLINGS
- STAINLESS STEEL BRAID
- POWER CRIMP COUPLINGS
- FIELD ATTACHABLE G1 & G2 COUPLINGS
- FIELD ATTACHABLE C5 COUPLINGS
- C14 COUPLINGS
- GL COUPLINGS
- GLX COUPLINGS
- PCTS THERMOPLASTIC COUPLINGS
- POLARSEAL COUPLINGS (ACA)**
- POLARSEAL II COUPLINGS (ACC)
- POLARSEAL II COUPLINGS (ACB)
- POWER STEERING
- ADAPTERS
- QUICK DISCONNECT COUPLERS
- BALL VALVES
- LIVE SWIVEL
- ASSEMBLY FABRICATION
- ACCESSORIES
- EQUIPMENT AND PARTS
- KITS
- AIR BRAKE HOSE ASSY
- BRASS



EQUIPMENT
HOSE/CPLG. SELECTION
G8K COUPLINGS
GLOBAL SPIRAL COUPLINGS
STAINLESS STEEL SPIRAL
MEGACRIMP COUPLINGS
STAINLESS STEEL BRAID
POWER CRIMP COUPLINGS
FIELD ATTACHABLE G1 & G2 COUPLINGS
FIELD ATTACHABLE C5 COUPLINGS
C14 COUPLINGS
GL COUPLINGS
GLX COUPLINGS
PCTS THERMOPLASTIC COUPLINGS
<b>POLARSEAL COUPLINGS (ACA)</b>
POLARSEAL II COUPLINGS (ACC)
POLARSEAL II COUPLINGS (ACB)
POWER STEERING
ADAPTERS
QUICK DISCONNECT COUPLERS
BALL VALVES
LIVE SWIVEL
ASSEMBLY FABRICATION
ACCESSORIES
EQUIPMENT AND PARTS
KITS
AIR BRAKE HOSE ASSY
BRASS

## Hose Splicer with R134a Service Port - Steel

Service Ports: High Side; -6, -8 Hose  
 Service Ports: Low Side; -10, -12 Hose

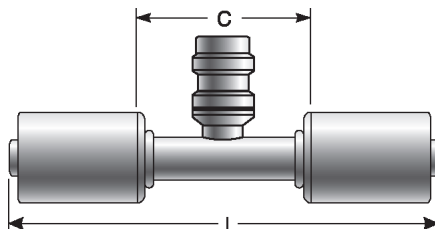

Part No.	Descr.	Prod. No.	⊖	L	C
			"	"	"
G45956-0606S	6ACA-R134SP-S	7332-01955	5/16	4.50	2.00
G45956-0808S	8ACA-R134SP-S	7332-01965	13/32	4.50	2.00
G45956-1010S	10ACA-R134SP-S	7332-01975	1/2	4.63	2.13
G45956-1212S	12ACA-R134SP-S	7332-03005	5/8	4.75	2.25

## Female Rotalok (Compressor Connection) with R134a Service Port - 90° Block - Aluminum

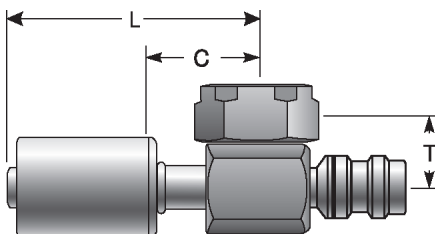

Part No.	Descr.	Prod. No.	⊖	🌀	T	L	C
			"	"	"	"	"
G45957-0816	8ACA-R134SP-RL	7332-01215	13/32	1-14	.78	2.45	1.20
G45957-1016	10ACA-R134SP-RL	7332-01225	1/2	1-14	.78	2.51	1.26





### Compressor Female SAE Tube O-Ring Nut Swivel - 90° Bent Tube - Steel

O-Ring not included. Must be ordered separately.

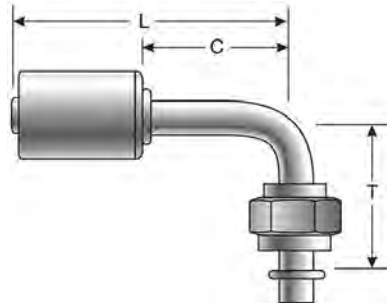

Part No.	Descr.	Prod. No.	⊖		T	L	C
			"	"	"	"	"
G45958-0606S	6ACA-6CFTON90-S	7332-04465	5/16	1-14	.84	.94	2.44
G45958-0810S	8ACA-10CFTON90-S	7332-02335	13/32	1-14	1.50	3.01	1.42
G45958-1010S	10ACA-10CFTON90-S	7332-04475	1/2	1-14	.84	.94	2.63
G45958-1210S	12ACA-10CFTON90-S	7332-02065	5/8	1-14	1.63	3.18	1.60

### Compressor Female SAE Tube O-Ring Nut Swivel - 90° Block - Steel

O-Ring not included. Must be ordered separately.

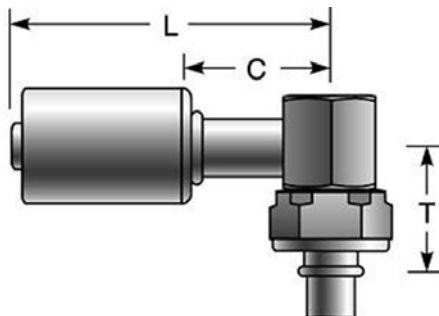

Part No.	Descr.	Prod. No.	⊖		T	L	C
			"	"	"	"	"
G45959-0810S	8ACA-10CFTON90BL-S	7332-02095	13/32	1-14	.80	3.02	1.43
G45959-1210S	12ACA-10CFTON90BL-S	7332-02105	5/8	1-14	.80	3.14	1.55

- EQUIPMENT
- HOSE/CPLG. SELECTION
- G8K COUPLINGS
- GLOBALSPIRAL COUPLINGS
- STAINLESS STEEL SPIRAL
- MEGACRIMP COUPLINGS
- STAINLESS STEEL BRAID
- POWER CRIMP COUPLINGS
- FIELD ATTACHABLE G1 & G2 COUPLINGS
- FIELD ATTACHABLE C5 COUPLINGS
- C14 COUPLINGS
- GL COUPLINGS
- GLX COUPLINGS
- PCTS THERMOPLASTIC COUPLINGS
- POLARSEAL COUPLINGS (ACA)**
- POLARSEAL II COUPLINGS (ACC)
- POLARSEAL II COUPLINGS (ACB)
- POWER STEERING
- ADAPTERS
- QUICK DISCONNECT COUPLERS
- BALL VALVES
- LIVE SWIVEL
- ASSEMBLY FABRICATION
- ACCESSORIES
- EQUIPMENT AND PARTS
- KITS
- AIR BRAKE HOSE ASSY
- BRASS



EQUIPMENT
HOSE/CPLG. SELECTION
G8K COUPLINGS
GLOBAL SPIRAL COUPLINGS
STAINLESS STEEL SPIRAL
MEGACRIMP COUPLINGS
STAINLESS STEEL BRAID
POWER CRIMP COUPLINGS
FIELD ATTACHABLE G1 & G2 COUPLINGS
FIELD ATTACHABLE C5 COUPLINGS
C14 COUPLINGS
GL COUPLINGS
GLX COUPLINGS
PCTS THERMOPLASTIC COUPLINGS
<b>POLARSEAL COUPLINGS (ACA)</b>
POLARSEAL II COUPLINGS (ACC)
POLARSEAL II COUPLINGS (ACB)
POWER STEERING
ADAPTERS
QUICK DISCONNECT COUPLERS
BALL VALVES
LIVE SWIVEL
ASSEMBLY FABRICATION
ACCESSORIES
EQUIPMENT AND PARTS
KITS
AIR BRAKE HOSE ASSY
BRASS

## Compressor Female Tube O-Ring Nut with 134a Service Port - 90° Block - Steel

O-Ring not included. Must be ordered separately.

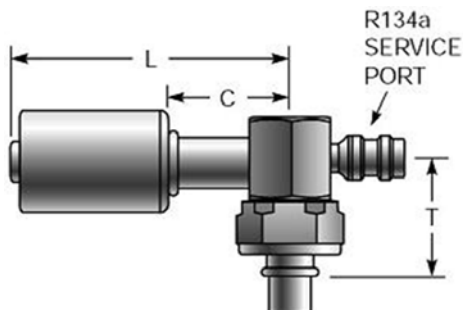

Part No.	Descr.	Prod. No.	⊖	🌀	T	L	C
			"	"	"	"	"
G45960-0810S	8ACA-10CFTON134SP90BL-S	7332-03865	13/32	1-14	.78	2.45	1.20
G45960-1010S	10ACA-10CFTON134SP90BL-S	7332-03875	1/2	1-14	.78	2.51	1.26
G45960-1210S	12ACA-10CFTON134SP90BL-S	7332-02755	5/8	1-14	.78	2.67	1.42

## Compressor Block - Single w/Switch or Service Port - 90° Bent Tube - Aluminum

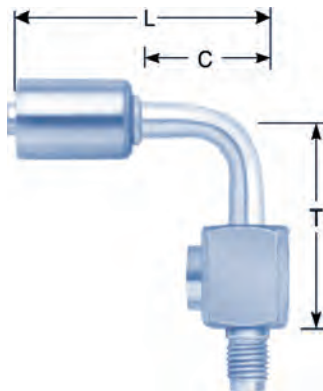

Part No.	Descr.	Prod. No.	⊖	🌀	T	L	C
			"	"	"	"	"
G45961-0808	8ACA-8CBSR12SP90	7332-03935	13/32	3/4-16	1.31	3.62	2.37
G45961-1008	10ACA-8CBSR12SP90	7332-03945	1/2	3/4-16	1.31	3.88	2.63
G45961-1208	12ACA-8CBSR12SP90	7332-03955	5/8	3/4-16	1.31	4.17	2.94



## Compressor Block - Single Reverse w/Switch or Service Port - 90° Bent Tube - Aluminum

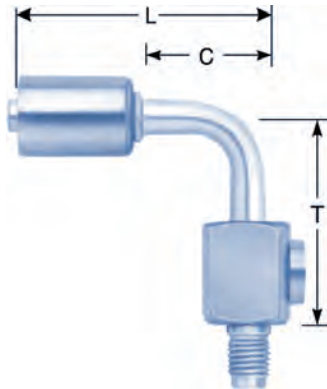

Part No.	Descr.	Prod. No.	⊖	🌀	T	L	C
			"	"	"	"	"
G45962-0808	8ACA-8CBSRR12SP90	7332-03965	13/32	3/4-16	1.31	3.62	2.37
G45962-1008	10ACA-8CBSRR12SP90	7332-03975	1/2	3/4-16	1.31	3.88	2.63
G45962-1208	12ACA-8CBSRR12SP90	7332-03985	5/8	3/4-16	1.31	4.17	2.94

## R12 Ferrules



Part No.	Descr.	Prod. No.
83930	6PCACF	7334-71305
83931	8PCACF	7334-71315
83932	10PCACF	7334-71325
83933	12PCACF	7334-71335

## Inline Orifice Tube

Description: The orifice tube is found on an accumulator air conditioning system. It is the dividing point between high and low pressure sides of the refrigeration system. The orifice tube filters and restricts high-pressure refrigerant in the liquid line and meters refrigerant flow as a low-pressure liquid. It is located in the refrigerant line between the condenser outlet and the evaporator inlet. The tube should be replaced any time the air conditioning system is opened for service.



Part No.	Descr.	Prod. No.	∅	L	
			"	"	mm
G46011-0062	IOT-RED	7332-02805	.062	3.50	88.9

- EQUIPMENT
- HOSE/CPLG. SELECTION
- G8K COUPLINGS
- GLOBALSPIRAL COUPLINGS
- STAINLESS STEEL SPIRAL
- MEGACRIMP COUPLINGS
- STAINLESS STEEL BRAID
- POWER CRIMP COUPLINGS
- FIELD ATTACHABLE G1 & G2 COUPLINGS
- FIELD ATTACHABLE C5 COUPLINGS
- C14 COUPLINGS
- GL COUPLINGS
- GLX COUPLINGS
- PCTS THERMOPLASTIC COUPLINGS
- POLARSEAL COUPLINGS (ACA)**
- POLARSEAL II COUPLINGS (ACC)
- POLARSEAL II COUPLINGS (ACB)
- POWER STEERING
- ADAPTERS
- QUICK DISCONNECT COUPLERS
- BALL VALVES
- LIVE SWIVEL
- ASSEMBLY FABRICATION
- ACCESSORIES
- EQUIPMENT AND PARTS
- KITS
- AIR BRAKE HOSE ASSY
- BRASS



EQUIPMENT
HOSE/CPLG. SELECTION
G8K COUPLINGS
GLOBAL SPIRAL COUPLINGS
STAINLESS STEEL SPIRAL
MEGACRIMP COUPLINGS
STAINLESS STEEL BRAID
POWER CRIMP COUPLINGS
FIELD ATTACHABLE G1 & G2 COUPLINGS
FIELD ATTACHABLE C5 COUPLINGS
C14 COUPLINGS
GL COUPLINGS
GLX COUPLINGS
PCTS THERMOPLASTIC COUPLINGS
<b>POLARSEAL COUPLINGS (ACA)</b>
POLARSEAL II COUPLINGS (ACC)
POLARSEAL II COUPLINGS (ACB)
POWER STEERING
ADAPTERS
QUICK DISCONNECT COUPLERS
BALL VALVES
LIVE SWIVEL
ASSEMBLY FABRICATION
ACCESSORIES
EQUIPMENT AND PARTS
KITS
AIR BRAKE HOSE ASSY
BRASS

### Inline Orifice Tube - Continued

Part No.	Descr.	Prod. No.		L	
			"	"	mm
G46010-0072	IOT-WHITE	7332-02775	.072	3.50	88.9
G46011-0072	IOT-BLUE	7332-02785	.072	3.50	88.9
G46010-1072	IOT-BLACK	7332-02815	.072	3.50	88.9

### Female Flareless Nut - Aluminum

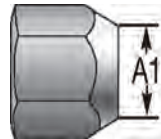

Part No.	Descr.	Prod. No.		A1
			"	"
G46050-0006	6ACFFN	7332-04135	5/8-18	3/8
G46050-0008	8ACFFN	7332-04145	3/4-16	1/2
G46050-0010	10ACFFN	7332-04155	7/8-14	5/8
G46050-0012	12ACFFN	7332-04165	1 1/16-14	3/4

### Female Flareless Sleeve

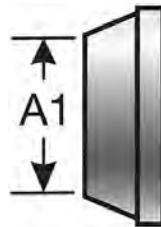

Part No.	Descr.	Prod. No.	A1
			"
G46051-0006	6ACFFS	7332-04175	3/8
G46051-0008	8ACFFS	7332-04185	1/2
G46051-0010	10ACFFS	7332-04195	5/8
G46051-0012	12ACFFS	7332-04205	3/4



### Metric Female Flareless Sleeve



Part No.	Descr.	Prod. No.	A1
			mm
G46052-0008	8ACMFFS	7332-04215	8.0
G46052-0012	12ACMFFS	7332-04225	12.0
G46052-0014	14.5ACMFFS	7332-04235	14.5

### Accumulator/Compressor Sealing Washer



Part No.	Descr.	Prod. No.	
			"
G46091-0010	10CPWTN	7332-04015	5/8
G46092-0010	10CPWTK	7332-04035	5/8
G46090-0012	12ACMW	7332-04005	3/4
G46091-0012	12CPWTN	7332-04025	3/4

### Valve Core

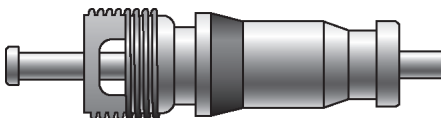

Part No.	Descr.	Prod. No.	
			"
G46093-0000	.210VC	7332-04045	.210x36

- EQUIPMENT
- HOSE/CPLG. SELECTION
- G8K COUPLINGS
- GLOBALSPIRAL COUPLINGS
- STAINLESS STEEL SPIRAL
- MEGACRIMP COUPLINGS
- STAINLESS STEEL BRAID
- POWER CRIMP COUPLINGS
- FIELD ATTACHABLE G1 & G2 COUPLINGS
- FIELD ATTACHABLE C5 COUPLINGS
- C14 COUPLINGS
- GL COUPLINGS
- GLX COUPLINGS
- PCTS THERMOPLASTIC COUPLINGS
- POLARSEAL COUPLINGS (ACA)**
- POLARSEAL II COUPLINGS (ACC)
- POLARSEAL II COUPLINGS (ACB)
- POWER STEERING
- ADAPTERS
- QUICK DISCONNECT COUPLERS
- BALL VALVES
- LIVE SWIVEL
- ASSEMBLY FABRICATION
- ACCESSORIES
- EQUIPMENT AND PARTS
- KITS
- AIR BRAKE HOSE ASSY
- BRASS



EQUIPMENT
HOSE/CPLG. SELECTION
G8K COUPLINGS
GLOBAL SPIRAL COUPLINGS
STAINLESS STEEL SPIRAL
MEGACRIMP COUPLINGS
STAINLESS STEEL BRAID
POWER CRIMP COUPLINGS
FIELD ATTACHABLE G1 & G2 COUPLINGS
FIELD ATTACHABLE C5 COUPLINGS
C14 COUPLINGS
GL COUPLINGS
GLX COUPLINGS
PCTS THERMOPLASTIC COUPLINGS
<b>POLARSEAL COUPLINGS (ACA)</b>
POLARSEAL II COUPLINGS (ACC)
POLARSEAL II COUPLINGS (ACB)
POWER STEERING
ADAPTERS
QUICK DISCONNECT COUPLERS
BALL VALVES
LIVE SWIVEL
ASSEMBLY FABRICATION
ACCESSORIES
EQUIPMENT AND PARTS
KITS
AIR BRAKE HOSE ASSY
BRASS

### Valve Cap for R12 Service Port

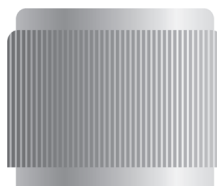

Part No.	Descr.	Prod. No.	
G46094-0004	4R12CAP	7332-04055	"
			7/16-20

### Red High Side Cap R134a Port

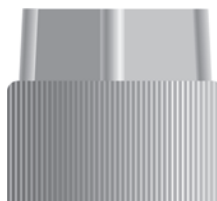

Part No.	Descr.	Prod. No.	
G46095-0008	8HS134CAP	7332-04115	"
			8

### Blue Low Side Cap R134a Port

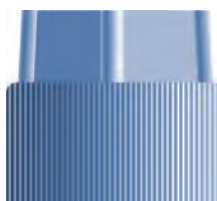

Part No.	Descr.	Prod. No.	
G46096-0008	8LS134CAP	7332-04125	"
			8



### O-Ring for Switch



Part No.	Descr.	Prod. No.	Inside Diameter
			"
G46097-0006	6SWOR	7332-04065	3/8

### O-Rings for PolarSeal® Couplings



Part No.	Descr.	Prod. No.	Inside Diameter	Wall Thickness
			"	"
G46098-0006	6ACOR	7332-01235	.30	.070
G46098-0008	8ACOR	7332-01245	.43	.070
G46098-0010	10ACOR	7332-01255	.55	.070
G46098-0012	12ACOR	7332-01265	.68	.070

### O-Ring for Ford Spring Lock



Part No.	Descr.	Prod. No.	Inside Diameter
			"
G46099-0006	6FSLOR	7332-04075	3/8
G46099-0008	8FSLOR	7332-04085	1/2
G46099-0010	10FSLOR	7332-04095	5/8
G46099-0012	12FSLOR	7332-04105	3/4

- EQUIPMENT
- HOSE/CPLG. SELECTION
- G8K COUPLINGS
- GLOBALSPIRAL COUPLINGS
- STAINLESS STEEL SPIRAL
- MEGACRIMP COUPLINGS
- STAINLESS STEEL BRAID
- POWER CRIMP COUPLINGS
- FIELD ATTACHABLE G1 & G2 COUPLINGS
- FIELD ATTACHABLE C5 COUPLINGS
- C14 COUPLINGS
- GL COUPLINGS
- GLX COUPLINGS
- PCTS THERMOPLASTIC COUPLINGS
- POLARSEAL COUPLINGS (ACA)**
- POLARSEAL II COUPLINGS (ACC)
- POLARSEAL II COUPLINGS (ACB)
- POWER STEERING
- ADAPTERS
- QUICK DISCONNECT COUPLERS
- BALL VALVES
- LIVE SWIVEL
- ASSEMBLY FABRICATION
- ACCESSORIES
- EQUIPMENT AND PARTS
- KITS
- AIR BRAKE HOSE ASSY
- BRASS





**NOTES**

EQUIPMENT
HOSE/CPLG. SELECTION
G8K COUPLINGS
GLOBAL SPIRAL COUPLINGS
STAINLESS STEEL SPIRAL
MEGACRIMP COUPLINGS
STAINLESS STEEL BRAID
POWER CRIMP COUPLINGS
FIELD ATTACHABLE G1 & G2 COUPLINGS
FIELD ATTACHABLE C5 COUPLINGS
C14 COUPLINGS
GL COUPLINGS
GLX COUPLINGS
PCTS THERMOPLASTIC COUPLINGS
<b>POLARSEAL COUPLINGS (ACA)</b>
POLARSEAL II COUPLINGS (ACC)
POLARSEAL II COUPLINGS (ACB)
POWER STEERING
ADAPTERS
QUICK DISCONNECT COUPLERS
BALL VALVES
LIVE SWIVEL
ASSEMBLY FABRICATION
ACCESSORIES
EQUIPMENT AND PARTS
KITS
AIR BRAKE HOSE ASSY
BRASS



# HYDRAULIC HOSE FOR POLARSEAL® II (ACB & ACC) COUPLINGS



EQUIPMENT
HOSE/CPLG. SELECTION
G8K COUPLINGS
GLOBALSPIRAL COUPLINGS
STAINLESS STEEL SPIRAL
MEGACRIMP COUPLINGS
STAINLESS STEEL BRAID
POWER CRIMP COUPLINGS
FIELD ATTACHABLE G1 & G2 COUPLINGS
FIELD ATTACHABLE C5 COUPLINGS
C14 COUPLINGS
GL COUPLINGS
GLX COUPLINGS
PCTS THERMOPLASTIC COUPLINGS
POLARSEAL COUPLINGS (ACA)
<b>POLARSEAL II COUPLINGS (ACC)</b>
POLARSEAL II COUPLINGS (ACB)
POWER STEERING
ADAPTERS
QUICK DISCONNECT COUPLERS
BALL VALVES
LIVE SWIVEL
ASSEMBLY FABRICATION
ACCESSORIES
EQUIPMENT AND PARTS
KITS
AIR BRAKE HOSE ASSY
BRASS

**The Gates eCrimp program** is a web based utility which allows users and distributors of Gates hydraulic and industrial hose products to find and print the most up to date crimp specifications with nothing more than an internet browser.

This program can be used to find crimp data for all Gates crimpers. Custom result may be printed by selecting the crimper, hose and coupling. Optionally results may also be limited by die set and working pressure.

The eCrimp web application can be directly accessed from a web browser by entering <http://eCrimp.Gates.com> for the website.

**The eCrimp mobile app** is available for download for the iPhone and iPad from the App Store.



EQUIPMENT
HOSE/CPLG. SELECTION
G8K COUPLINGS
GLOBAL SPIRAL COUPLINGS
STAINLESS STEEL SPIRAL
MEGACRIMP COUPLINGS
STAINLESS STEEL BRAID
POWER CRIMP COUPLINGS
FIELD ATTACHABLE G1 & G2 COUPLINGS
FIELD ATTACHABLE C5 COUPLINGS
C14 COUPLINGS
GL COUPLINGS
GLX COUPLINGS
PCTS THERMOPLASTIC COUPLINGS
POLARSEAL COUPLINGS (ACA)
<b>POLARSEAL II COUPLINGS (ACC)</b>
POLARSEAL II COUPLINGS (ACB)
POWER STEERING
ADAPTERS
QUICK DISCONNECT COUPLERS
BALL VALVES
LIVE SWIVEL
ASSEMBLY FABRICATION
ACCESSORIES
EQUIPMENT AND PARTS
KITS
AIR BRAKE HOSE ASSY
BRASS

### Male Flareless Assembly

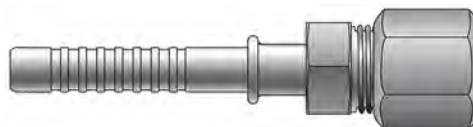

Part No.	Descr.	Prod. No.	Standard Pack
G46510-0606	6ACC-6MFA	7332-51355	1
G46510-0808	8ACC-8MFA	7332-51365	1
G46510-1010	10ACC-10MFA	7332-51375	1
G46510-1212	12ACC-12MFA	7332-51385	1

### Male Flareless Assembly - 90° Bent Tube

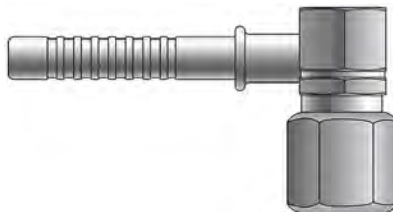

Part No.	Descr.	Prod. No.	Standard Pack
G46511-0606	6ACC-6MFA90	7332-51395	1
G46511-0808	8ACC-8MFA90	7332-51405	1
G46511-1010	10ACC-10MFA90	7332-51415	1
G46511-1212	12ACC-12MFA90	7332-51425	1

### Weld On Hose End

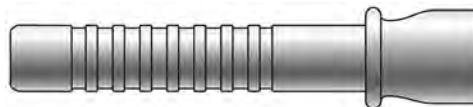

Part No.	Descr.	Prod. No.	⊕
G46527-0606	6ACC-6FBO	7332-51165	5/16
G46527-0808	8ACC-8FBO	7332-51175	13/32
G46527-1010	10ACC-10FBO	7332-51185	1/2
G46527-1210	12ACC-10FBO	7332-51345	5/8
G46527-1212	12ACC-12FBO	7332-51195	5/8
G46527-1216	12ACC-16FBO	7332-51205	5/8



### Splicer



Part No.	Descr.	Prod. No.	⊖	🌀
			"	"
G46535-0606	6ACC-6HLE	7332-50915	5/16	6
G46535-0808	8ACC-8HLE	7332-50925	13/32	8
G46535-1010	10ACC-10HLE	7332-50935	1/2	10
G46535-1212	12ACC-12HLE	7332-50945	5/8	12

### T Splicer



Part No.	Descr.	Prod. No.	⊖	🌀
			"	"
G46539-0606	6ACC-6HLET	7332-51085	5/16	6
G46539-0808	8ACC-8HLET	7332-51095	13/32	8
G46539-1010	10ACC-10HLET	7332-51105	1/2	10
G46539-1212	12ACC-12HLET	7332-51115	5/8	12

### Y Splicer

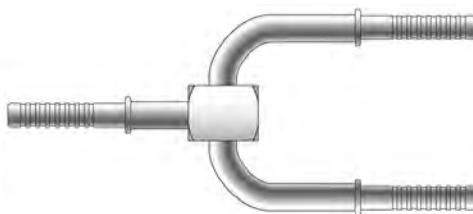

Part No.	Descr.	Prod. No.	⊖	🌀
			"	"
G46542-0808	8ACC-8HLEY	7332-51135	13/32	8
G46542-1010	10ACC-10HLEY	7332-51145	1/2	10
G46542-1212	12ACC-12HLEY	7332-51155	5/8	12

EQUIPMENT
HOSE/CPLG. SELECTION
G8K COUPLINGS
GLOBALSPIRAL COUPLINGS
STAINLESS STEEL SPIRAL
MEGACRIMP COUPLINGS
STAINLESS STEEL BRAID
POWER CRIMP COUPLINGS
FIELD ATTACHABLE G1 & G2 COUPLINGS
FIELD ATTACHABLE C5 COUPLINGS
C14 COUPLINGS
GL COUPLINGS
GLX COUPLINGS
PCTS THERMOPLASTIC COUPLINGS
POLARSEAL COUPLINGS (ACA)
POLARSEAL II COUPLINGS (ACC)
POLARSEAL II COUPLINGS (ACB)
POWER STEERING
ADAPTERS
QUICK DISCONNECT COUPLERS
BALL VALVES
LIVE SWIVEL
ASSEMBLY FABRICATION
ACCESSORIES
EQUIPMENT AND PARTS
KITS
AIR BRAKE HOSE ASSY
BRASS



EQUIPMENT
HOSE/CPLG. SELECTION
G8K COUPLINGS
GLOBAL SPIRAL COUPLINGS
STAINLESS STEEL SPIRAL
MEGACRIMP COUPLINGS
STAINLESS STEEL BRAID
POWER CRIMP COUPLINGS
FIELD ATTACHABLE G1 & G2 COUPLINGS
FIELD ATTACHABLE C5 COUPLINGS
C14 COUPLINGS
GL COUPLINGS
GLX COUPLINGS
PCTS THERMOPLASTIC COUPLINGS
POLARSEAL COUPLINGS (ACA)
<b>POLARSEAL II COUPLINGS (ACC)</b>
POLARSEAL II COUPLINGS (ACB)
POWER STEERING
ADAPTERS
QUICK DISCONNECT COUPLERS
BALL VALVES
LIVE SWIVEL
ASSEMBLY FABRICATION
ACCESSORIES
EQUIPMENT AND PARTS
KITS
AIR BRAKE HOSE ASSY
BRASS

### Male O-Ring - 180° Bent Tube

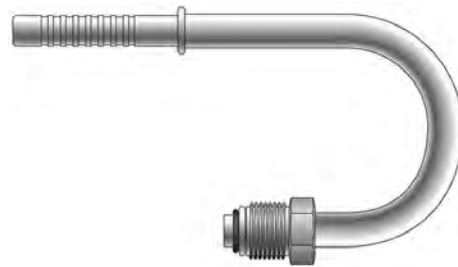

Part No.	Descr.	Prod. No.	⊖	🌀
			"	"
G46578-0606	6ACC-6MTON180	7332-50895	5/16	5/8-18
G46578-1010	10ACC-10MTON180	7332-50905	5/8	7/8-14

### Male O-Ring with Switch or Service Port - 90° Bent Tube

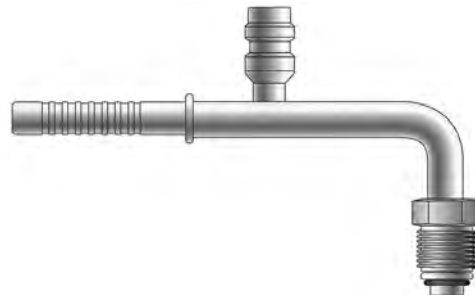

Part No.	Descr.	Prod. No.	⊖	🌀
			"	"
G46582-0808H	8ACC-8MTON90134SWPH	7332-50695	13/32	3/4-16

### Male O-Ring

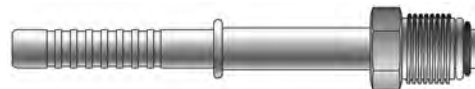

Part No.	Descr.	Prod. No.	⊖	🌀
			"	"
G46583-0606	6ACC-6MTON	7332-50525	5/16	5/8-18
G46583-0806	8ACC-6MTON	7332-50585	13/32	5/8-18
G46583-0808	8ACC-8MTON	7332-50535	13/32	3/4-16
G46583-1010	10ACC-10MTON	7332-50545	1/2	7/8-14
G46583-1210	12ACC-10MTON	7332-50595	5/8	7/8-14
G46583-1212	12ACC-12MTON	7332-50565	5/8	1 1/16-14
G46583-1610	16ACC-10MTON	7332-50555	7/8	7/8-14
G46583-1612	16ACC-12MTON	7332-50575	7/8	1 1/16-14



### Male O-Ring - 45° Bent Tube



Part No.	Descr.	Prod. No.		
			"	"
G46584-0606	6ACC-6MTON45	7332-50605	5/16	5/8-18
G46584-1210	12ACC-10MTON45	7332-50615	5/8	7/8-14

### Male O-Ring - 90° Bent Tube

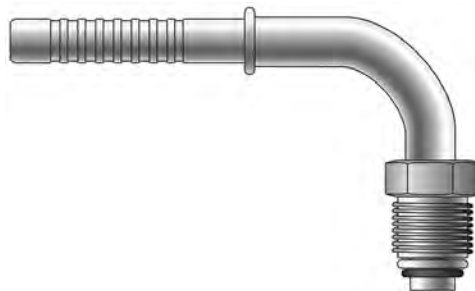

Part No.	Descr.	Prod. No.		
			"	"
G46585-0606	6ACC-6MTON90	7332-50625	5/16	5/8-18
G46585-0806	8ACC-6MTON90	7332-50665	13/32	5/8-18
G46585-0808	8ACC-8MTON90	7332-50635	13/32	3/4-16
G46585-1008	10ACC-8MTON90	7332-50675	1/2	3/4-16
G46585-1010	10ACC-10MTON90	7332-50645	1/2	7/8-14
G46585-1210	12ACC-10MTON90	7332-50685	5/8	7/8-14
G46585-1212	12ACC-12MTON90	7332-50655	5/8	1 1/16-14

### Straight Female O-Ring with R134 Service Port H

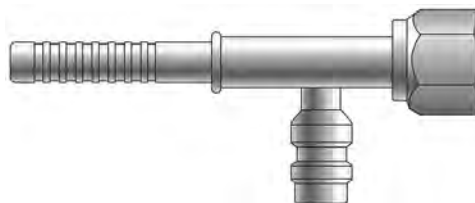

Part No.	Descr.	Prod. No.		
			"	"
G46588-0808H	8ACC-8FTON134SPH	7332-50135	13/32	3/4-16

EQUIPMENT
HOSE/CPLG. SELECTION
G8K COUPLINGS
GLOBALSPIRAL COUPLINGS
STAINLESS STEEL SPIRAL
MEGACRIMP COUPLINGS
STAINLESS STEEL BRAID
POWER CRIMP COUPLINGS
FIELD ATTACHABLE G1 & G2 COUPLINGS
FIELD ATTACHABLE C5 COUPLINGS
C14 COUPLINGS
GL COUPLINGS
GLX COUPLINGS
PCTS THERMOPLASTIC COUPLINGS
POLARSEAL COUPLINGS (ACA)
<b>POLARSEAL II COUPLINGS (ACC)</b>
POLARSEAL II COUPLINGS (ACB)
POWER STEERING
ADAPTERS
QUICK DISCONNECT COUPLERS
BALL VALVES
LIVE SWIVEL
ASSEMBLY FABRICATION
ACCESSORIES
EQUIPMENT AND PARTS
KITS
AIR BRAKE HOSE ASSY
BRASS



EQUIPMENT
HOSE/CPLG. SELECTION
G8K COUPLINGS
GLOBAL SPIRAL COUPLINGS
STAINLESS STEEL SPIRAL
MEGACRIMP COUPLINGS
STAINLESS STEEL BRAID
POWER CRIMP COUPLINGS
FIELD ATTACHABLE G1 & G2 COUPLINGS
FIELD ATTACHABLE C5 COUPLINGS
C14 COUPLINGS
GL COUPLINGS
GLX COUPLINGS
PCTS THERMOPLASTIC COUPLINGS
POLARSEAL COUPLINGS (ACA)
<b>POLARSEAL II COUPLINGS (ACC)</b>
POLARSEAL II COUPLINGS (ACB)
POWER STEERING
ADAPTERS
QUICK DISCONNECT COUPLERS
BALL VALVES
LIVE SWIVEL
ASSEMBLY FABRICATION
ACCESSORIES
EQUIPMENT AND PARTS
KITS
AIR BRAKE HOSE ASSY
BRASS

### Straight Female O-Ring with R134 Service Port H - Continued

Part No.	Descr.	Prod. No.		
			"	"
G46588-1008H	10ACC-8FTON134SPH	7332-50195	1/2	3/4-16

### Straight Female O-Ring with R134 Service Port L

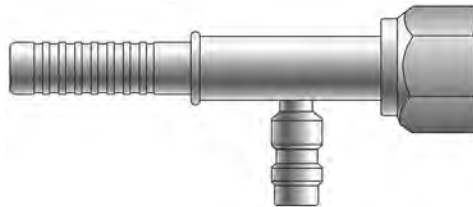

Part No.	Descr.	Prod. No.		
			"	"
G46588-1010L	10ACC-10FTON134SPL	7332-50145	1/2	7/8-14
G46588-1210L	12ACC-10FTON134SPL	7332-50205	5/8	7/8-14
G46588-1212L	12ACC-12FTON134SPL	7332-50175	5/8	1 1/16-14
G46588-1610L	16ACC-10FTON134SPL	7332-50155	7/8	7/8-14

### Straight Female O-Ring with Switch Port M

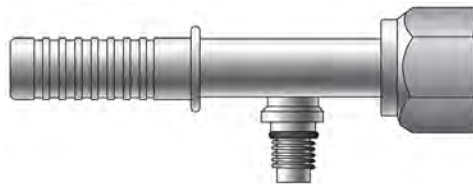

Part No.	Descr.	Prod. No.		
			"	"
G46588-1210M	12ACC-10FTONMSWP	7332-50215	5/8	7/8-14
G46588-1212M	12ACC-12FTONMSWP	7332-50185	5/8	1 1/16-14





### Straight Female O-Ring with Switch Port P

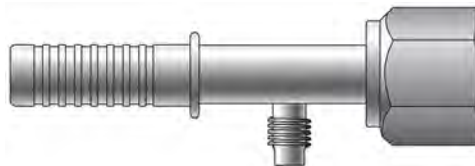

Part No.	Descr.	Prod. No.		
			"	"
G46588-0808P	8ACC-8FTONSWP	7332-50125	13/32	3/4-16
G46588-1212P	12ACC-12FTONSWP	7332-50165	5/8	1 1/16-14

### Female O-Ring with R134 Service Port H - 90° Bent Tube

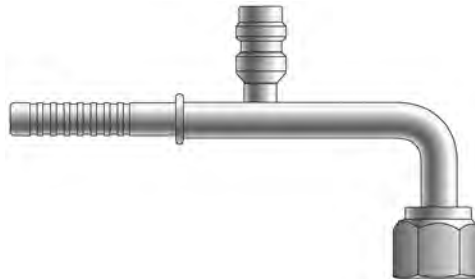

Part No.	Descr.	Prod. No.		
			"	"
G46589-0608H	6ACC-8FTON134SPH90	7332-50505	5/16	3/4-16
G46589-0808H	8ACC-8FTON134SPH90	7332-50415	13/32	3/4-16
G46589-1008H	10ACC-8FTON134SPH90	7332-50485	1/2	3/4-16
G46589-1010H	10ACC-10FTON134SPH90	7332-50445	1/2	7/8-14

### Female O-Ring with R134 Service Port L - 90° Bent Tube

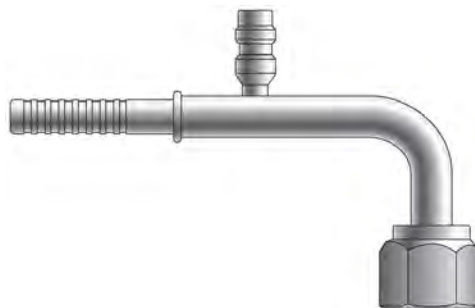

Part No.	Descr.	Prod. No.		
			"	"
G46589-1010L	10ACC-10FTON134SPL90	7332-50425	1/2	7/8-14

EQUIPMENT
HOSE/CPLG. SELECTION
G8K COUPLINGS
GLOBALSPIRAL COUPLINGS
STAINLESS STEEL SPIRAL
MEGACRIMP COUPLINGS
STAINLESS STEEL BRAID
POWER CRIMP COUPLINGS
FIELD ATTACHABLE G1 & G2 COUPLINGS
FIELD ATTACHABLE C5 COUPLINGS
C14 COUPLINGS
GL COUPLINGS
GLX COUPLINGS
PCTS THERMOPLASTIC COUPLINGS
POLARSEAL COUPLINGS (ACA)
<b>POLARSEAL II COUPLINGS (ACC)</b>
POLARSEAL II COUPLINGS (ACB)
POWER STEERING
ADAPTERS
QUICK DISCONNECT COUPLERS
BALL VALVES
LIVE SWIVEL
ASSEMBLY FABRICATION
ACCESSORIES
EQUIPMENT AND PARTS
KITS
AIR BRAKE HOSE ASSY
BRASS



EQUIPMENT
HOSE/CPLG. SELECTION
G8K COUPLINGS
GLOBAL SPIRAL COUPLINGS
STAINLESS STEEL SPIRAL
MEGACRIMP COUPLINGS
STAINLESS STEEL BRAID
POWER CRIMP COUPLINGS
FIELD ATTACHABLE G1 & G2 COUPLINGS
FIELD ATTACHABLE C5 COUPLINGS
C14 COUPLINGS
GL COUPLINGS
GLX COUPLINGS
PCTS THERMOPLASTIC COUPLINGS
POLARSEAL COUPLINGS (ACA)
<b>POLARSEAL II COUPLINGS (ACC)</b>
POLARSEAL II COUPLINGS (ACB)
POWER STEERING
ADAPTERS
QUICK DISCONNECT COUPLERS
BALL VALVES
LIVE SWIVEL
ASSEMBLY FABRICATION
ACCESSORIES
EQUIPMENT AND PARTS
KITS
AIR BRAKE HOSE ASSY
BRASS

### Female O-Ring with R134 Service Port L - 90° Bent Tube - Continued

Part No.	Descr.	Prod. No.		
			"	"
G46589-1210L	12ACC-10FTON134SPL90	7332-50515	5/8	7/8-14

### Female O-Ring with Switch Port M - 90° Bent Tube

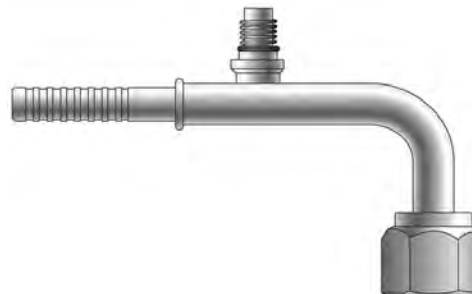

Part No.	Descr.	Prod. No.		
			"	"
G46589-1010M	10ACC-10FTONMSWP90	7332-50435	1/2	7/8-14
G46589-1212M	12ACC-12FTONMSWP90	7332-50465	5/8	1 1/16-14

### Female O-Ring with Switch Port P - 90° Bent Tube

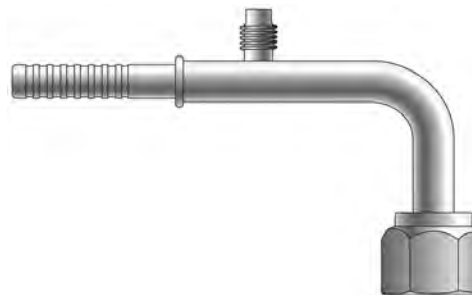

Part No.	Descr.	Prod. No.		
			"	"
G46589-0808P	8ACC-8FTONSWP90	7332-50405	13/32	3/4-16
G46589-1008P	10ACC-8FTONSWP90	7332-50475	1/2	3/4-16
G46589-1210P	12ACC-10FTONMSWP90	7332-50495	5/8	7/8-14
G46589-1212P	12ACC-12FTONSWP90	7332-50455	5/8	1 1/16-14



### Straight Female O-Ring

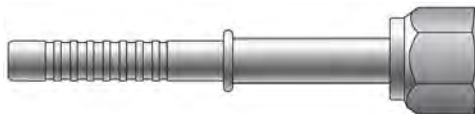

Part No.	Descr.	Prod. No.		
			"	"
G46590-0606	6ACC-6FTON	7332-50015	5/16	5/8-18
G46590-0608	6ACC-8FTON	7332-50105	5/16	3/4-16
G46590-0806	8ACC-6FTON	7332-50075	13/32	5/8-18
G46590-0808	8ACC-8FTON	7332-50025	13/32	3/4-16
G46590-0810	8ACC-10FTON	7332-50115	13/32	7/8-14
G46590-1008	10ACC-8FTON	7332-50085	1/2	3/4-16
G46590-1010	10ACC-10FTON	7332-50035	1/2	7/8-14
G46590-1210	12ACC-10FTON	7332-50095	5/8	7/8-14
G46590-1212	12ACC-12FTON	7332-50055	5/8	1 1/16-14
G46590-1610	16ACC-10FTON	7332-50045	7/8	7/8-14
G46590-1612	16ACC-12FTON	7332-50065	7/8	1 1/16-14

### Female O-Ring - 45° Bent Tube



Part No.	Descr.	Prod. No.		
			"	"
G46591-0606	6ACC-6FTON45	7332-50225	5/16	5/8-18
G46591-0808	8ACC-8FTON45	7332-50235	13/32	3/4-16
G46591-1008	10ACC-8FTON45	7332-50275	1/2	3/4-16
G46591-1010	10ACC-10FTON45	7332-50245	1/2	7/8-14
G46591-1210	12ACC-10FTON45	7332-50285	5/8	7/8-14
G46591-1212	12ACC-12FTON45	7332-50255	5/8	1 1/16-14
G46591-1612	16ACC-12FTON45	7332-50265	7/8	1 1/16-14

- EQUIPMENT
- HOSE/CPLG. SELECTION
- G8K COUPLINGS
- GLOBALSPIRAL COUPLINGS
- STAINLESS STEEL SPIRAL
- MEGACRIMP COUPLINGS
- STAINLESS STEEL BRAID
- POWER CRIMP COUPLINGS
- FIELD ATTACHABLE G1 & G2 COUPLINGS
- FIELD ATTACHABLE C5 COUPLINGS
- C14 COUPLINGS
- GL COUPLINGS
- GLX COUPLINGS
- PCTS THERMOPLASTIC COUPLINGS
- POLARSEAL COUPLINGS (ACA)
- POLARSEAL II COUPLINGS (ACC)**
- POLARSEAL II COUPLINGS (ACB)
- POWER STEERING
- ADAPTERS
- QUICK DISCONNECT COUPLERS
- BALL VALVES
- LIVE SWIVEL
- ASSEMBLY FABRICATION
- ACCESSORIES
- EQUIPMENT AND PARTS
- KITS
- AIR BRAKE HOSE ASSY
- BRASS



EQUIPMENT
HOSE/CPLG. SELECTION
G8K COUPLINGS
GLOBAL SPIRAL COUPLINGS
STAINLESS STEEL SPIRAL
MEGACRIMP COUPLINGS
STAINLESS STEEL BRAID
POWER CRIMP COUPLINGS
FIELD ATTACHABLE G1 & G2 COUPLINGS
FIELD ATTACHABLE C5 COUPLINGS
C14 COUPLINGS
GL COUPLINGS
GLX COUPLINGS
PCTS THERMOPLASTIC COUPLINGS
POLARSEAL COUPLINGS (ACA)
<b>POLARSEAL II COUPLINGS (ACC)</b>
POLARSEAL II COUPLINGS (ACB)
POWER STEERING
ADAPTERS
QUICK DISCONNECT COUPLERS
BALL VALVES
LIVE SWIVEL
ASSEMBLY FABRICATION
ACCESSORIES
EQUIPMENT AND PARTS
KITS
AIR BRAKE HOSE ASSY
BRASS

### Female O-Ring - 90° Bent Tube

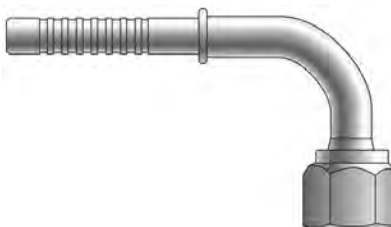

Part No.	Descr.	Prod. No.		
			"	"
G46592-0606	6ACC-6FTON90	7332-50295	5/16	5/8-18
G46592-0608	6ACC-8FTON90	7332-50385	5/16	3/4-16
G46592-0806	8ACC-6FTON90	7332-50355	13/32	5/8-18
G46592-0808	8ACC-8FTON90	7332-50305	13/32	3/4-16
G46592-0810	8ACC-10FTON90	7332-50395	13/32	7/8-14
G46592-1008	10ACC-8FTON90	7332-50365	1/2	3/4-16
G46592-1010	10ACC-10FTON90	7332-50315	1/2	7/8-14
G46592-1210	12ACC-10FTON90	7332-50375	5/8	7/8-14
G46592-1212	12ACC-12FTON90	7332-50335	5/8	1 1/16-14
G46592-1610	16ACC-10FTON90	7332-50325	7/8	7/8-14
G46592-1612	16ACC-12FTON90	7332-50345	7/8	1 1/16-14

### Metric Female O-Ring

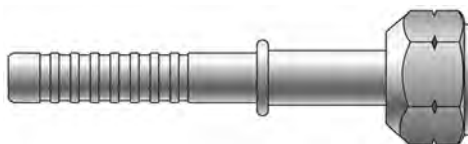

Part No.	Descr.	Prod. No.		
			"	"
G46593-0820	8ACC-20FTOMN	7332-51215	13/32	M20X1.5
G46593-1027	10ACC-27FTOMN	7332-51225	1/2	M27X2.0



### Metric Female O-Ring - 90° Bent Tube

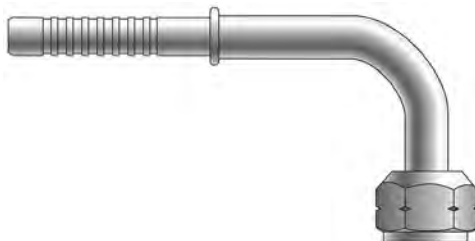

Part No.	Descr.	Prod. No.		
			"	"
G46595-0618	6ACC-18FTOMN90	7332-51235	5/16	M18X1.5
G46595-0820	8ACC-20FTOMN90	7332-51245	13/32	M20X1.5
G46595-1227	12ACC-27FTOMN90	7332-51255	5/8	M27X2.0

### Male Insert O-Ring

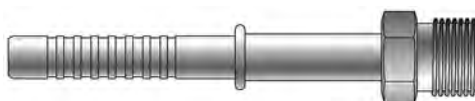

Part No.	Descr.	Prod. No.		
			"	"
G46597-0606	6ACC-6MIO	7332-50795	5/16	5/8-18
G46597-0806	8ACC-6MIO	7332-50815	13/32	5/8-18
G46597-0808	8ACC-8MIO	7332-50805	13/32	3/4-16
G46597-1210	12ACC-10MIO	7332-50825	5/8	7/8-14

### Male Insert O-Ring - 90° Bent Tube

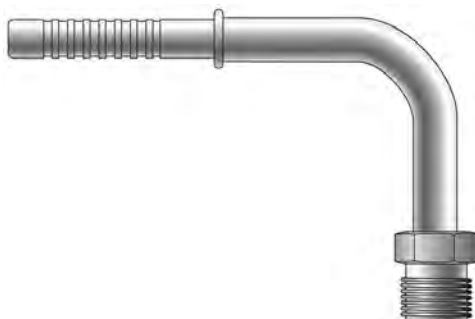

Part No.	Descr.	Prod. No.		
			"	"
G46599-0606	6ACC-6MIO90	7332-50835	5/16	5/8-18
G46599-0806	8ACC-6MIO90	7332-50865	13/32	5/8-18
G46599-0808	8ACC-8MIO90	7332-50845	13/32	3/4-16
G46599-1008	10ACC-8MIO90	7332-50875	1/2	3/4-16

EQUIPMENT
HOSE/CPLG. SELECTION
G8K COUPLINGS
GLOBALSPIRAL COUPLINGS
STAINLESS STEEL SPIRAL
MEGACRIMP COUPLINGS
STAINLESS STEEL BRAID
POWER CRIMP COUPLINGS
FIELD ATTACHABLE G1 & G2 COUPLINGS
FIELD ATTACHABLE C5 COUPLINGS
C14 COUPLINGS
GL COUPLINGS
GLX COUPLINGS
PCTS THERMOPLASTIC COUPLINGS
POLARSEAL COUPLINGS (ACA)
<b>POLARSEAL II COUPLINGS (ACC)</b>
POLARSEAL II COUPLINGS (ACB)
POWER STEERING
ADAPTERS
QUICK DISCONNECT COUPLERS
BALL VALVES
LIVE SWIVEL
ASSEMBLY FABRICATION
ACCESSORIES
EQUIPMENT AND PARTS
KITS
AIR BRAKE HOSE ASSY
BRASS



EQUIPMENT
HOSE/CPLG. SELECTION
G8K COUPLINGS
GLOBAL SPIRAL COUPLINGS
STAINLESS STEEL SPIRAL
MEGACRIMP COUPLINGS
STAINLESS STEEL BRAID
POWER CRIMP COUPLINGS
FIELD ATTACHABLE G1 & G2 COUPLINGS
FIELD ATTACHABLE C5 COUPLINGS
C14 COUPLINGS
GL COUPLINGS
GLX COUPLINGS
PCTS THERMOPLASTIC COUPLINGS
POLARSEAL COUPLINGS (ACA)
<b>POLARSEAL II COUPLINGS (ACC)</b>
POLARSEAL II COUPLINGS (ACB)
POWER STEERING
ADAPTERS
QUICK DISCONNECT COUPLERS
BALL VALVES
LIVE SWIVEL
ASSEMBLY FABRICATION
ACCESSORIES
EQUIPMENT AND PARTS
KITS
AIR BRAKE HOSE ASSY
BRASS

### Male Insert O-Ring - 90° Bent Tube - Continued

Part No.	Descr.	Prod. No.		
			"	"
G46599-1010	10ACC-10MIO90	7332-50855	1/2	7/8-14
G46599-1210	12ACC-10MIO90	7332-50885	5/8	7/8-14

### Male Insert O-Ring Bulkhead

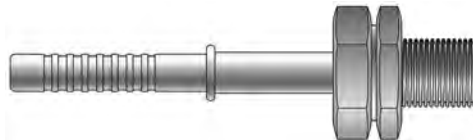

Part No.	Descr.	Prod. No.		
			"	"
G46600-0606	6ACC-6MIOBKHD	7332-50705	5/16	5/8-18
G46600-0808	8ACC-8MIOBKHD	7332-50715	13/32	3/4-16
G46600-1010	10ACC-10MIOBKHD	7332-50725	1/2	7/8-14
G46600-1210	12ACC-10MIOBKHD	7332-50745	5/8	7/8-14
G46600-1612	16ACC-12MIOBKHD	7332-50735	7/8	1 1/16-14

### Male Insert O-Ring Bulkhead - 90° Bent Tube

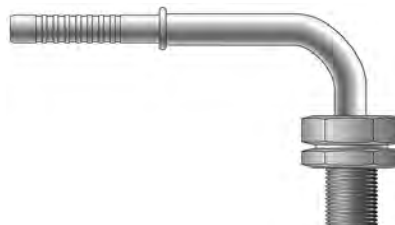

Part No.	Descr.	Prod. No.		
			"	"
G46602-0606	6ACC-6MIOBKHD90	7332-50755	5/16	5/8-18
G46602-0808	8ACC-8MIOBKHD90	7332-50765	13/32	3/4-16
G46602-1010	10ACC-10MIOBKHD90	7332-50775	1/2	7/8-14
G46602-1210	12ACC-10MIOBKHD90	7332-50785	5/8	7/8-14



### Splicer with R134 Service Port H

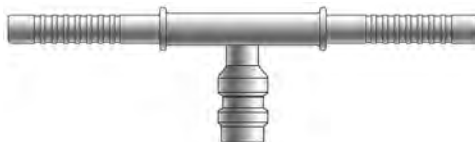

Part No.	Descr.	Prod. No.		
			"	"
G46956-0606H	6ACC-6HLE134SPH	7332-50965	5/16	6
G46956-0808H	8ACC-8HLE134SPH	7332-50985	13/32	8
G46956-1010H	10ACC-10HLE134SPH	7332-51035	1/2	10

### Splicer with R134 Service Port L

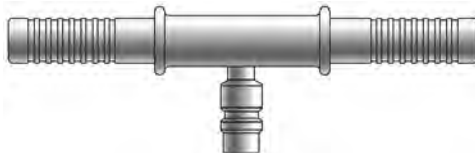

Part No.	Descr.	Prod. No.		
			"	"
G46956-1010L	10ACC-10HLE134SPL	7332-51015	1/2	10
G46956-1212L	12ACC-12HLE134SPL	7332-51055	5/8	12
G46956-1616L	16ACC-16HLE134SPL	7332-51075	7/8	16

### Splicer with Switch Port M



Part No.	Descr.	Prod. No.		
			"	"
G46956-0808M	8ACC-8HLEMSWP	7332-50995	13/32	8
G46956-1010M	10ACC-10HLEMSWP	7332-51025	1/2	10
G46956-1212M	12ACC-12HLEMSWP	7332-51065	5/8	12

EQUIPMENT
HOSE/CPLG. SELECTION
G8K COUPLINGS
GLOBALSPIRAL COUPLINGS
STAINLESS STEEL SPIRAL
MEGACRIMP COUPLINGS
STAINLESS STEEL BRAID
POWER CRIMP COUPLINGS
FIELD ATTACHABLE G1 & G2 COUPLINGS
FIELD ATTACHABLE C5 COUPLINGS
C14 COUPLINGS
GL COUPLINGS
GLX COUPLINGS
PCTS THERMOPLASTIC COUPLINGS
POLARSEAL COUPLINGS (ACA)
<b>POLARSEAL II COUPLINGS (ACC)</b>
POLARSEAL II COUPLINGS (ACB)
POWER STEERING
ADAPTERS
QUICK DISCONNECT COUPLERS
BALL VALVES
LIVE SWIVEL
ASSEMBLY FABRICATION
ACCESSORIES
EQUIPMENT AND PARTS
KITS
AIR BRAKE HOSE ASSY
BRASS





EQUIPMENT
HOSE/CPLG. SELECTION
G8K COUPLINGS
GLOBAL SPIRAL COUPLINGS
STAINLESS STEEL SPIRAL
MEGACRIMP COUPLINGS
STAINLESS STEEL BRAID
POWER CRIMP COUPLINGS
FIELD ATTACHABLE G1 & G2 COUPLINGS
FIELD ATTACHABLE C5 COUPLINGS
C14 COUPLINGS
GL COUPLINGS
GLX COUPLINGS
PCTS THERMOPLASTIC COUPLINGS
POLARSEAL COUPLINGS (ACA)
<b>POLARSEAL II COUPLINGS (ACC)</b>
POLARSEAL II COUPLINGS (ACB)
POWER STEERING
ADAPTERS
QUICK DISCONNECT COUPLERS
BALL VALVES
LIVE SWIVEL
ASSEMBLY FABRICATION
ACCESSORIES
EQUIPMENT AND PARTS
KITS
AIR BRAKE HOSE ASSY
BRASS

### Splicer with Switch Port P



Part No.	Descr.	Prod. No.		
			"	"
G46956-0606P	6ACC-6HLESWP	7332-50955	5/16	6
G46956-0808P	8ACC-8HLESWP	7332-50975	13/32	8
G46956-1010P	10ACC-10HLESWP	7332-51005	1/2	10
G46956-1212P	12ACC-12HLESWP	7332-51045	5/8	12

### Metric Female O-Ring with Switch or Service Port - 90° Bent Tube

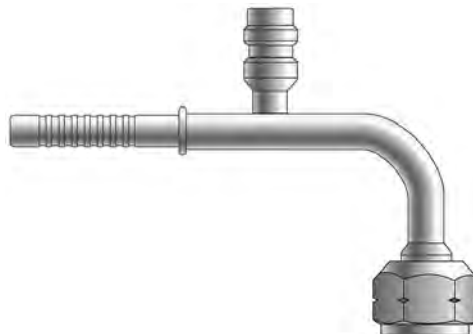

Part No.	Descr.	Prod. No.		
			"	"
G46963-0610	6ACC-10FTOMN90134SPH	7332-51265	5/16	M10X1.5

### Metric Male Insert O-Ring

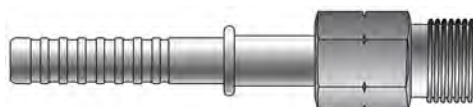

Part No.	Descr.	Prod. No.		
			"	"
G46965-1020	10ACC-20MIOM	7332-51285	1/2	M20X1.5



## Clamp Assemblies

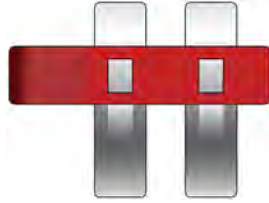

Part No.	Descr.	Prod. No.	
			"
G46995-0006	6CLAMP	7332-51295	5/16
G46995-0008	8CLAMP	7332-51305	13/32
G46995-0010	10CLAMP	7332-51315	1/2
G46995-0012	12CLAMP	7332-51325	5/8
G46995-0016	16CLAMP	7332-51335	7/8

EQUIPMENT
HOSE/CPLG. SELECTION
G8K COUPLINGS
GLOBALSPIRAL COUPLINGS
STAINLESS STEEL SPIRAL
MEGACRIMP COUPLINGS
STAINLESS STEEL BRAID
POWER CRIMP COUPLINGS
FIELD ATTACHABLE G1 & G2 COUPLINGS
FIELD ATTACHABLE C5 COUPLINGS
C14 COUPLINGS
GL COUPLINGS
GLX COUPLINGS
PCTS THERMOPLASTIC COUPLINGS
POLARSEAL COUPLINGS (ACA)
<b>POLARSEAL II COUPLINGS (ACC)</b>
POLARSEAL II COUPLINGS (ACB)
POWER STEERING
ADAPTERS
QUICK DISCONNECT COUPLERS
BALL VALVES
LIVE SWIVEL
ASSEMBLY FABRICATION
ACCESSORIES
EQUIPMENT AND PARTS
KITS
AIR BRAKE HOSE ASSY
BRASS



**NOTES**

EQUIPMENT
HOSE/CPLG. SELECTION
G8K COUPLINGS
GLOBAL SPIRAL COUPLINGS
STAINLESS STEEL SPIRAL
MEGACRIMP COUPLINGS
STAINLESS STEEL BRAID
POWER CRIMP COUPLINGS
FIELD ATTACHABLE G1 & G2 COUPLINGS
FIELD ATTACHABLE C5 COUPLINGS
C14 COUPLINGS
GL COUPLINGS
GLX COUPLINGS
PCTS THERMOPLASTIC COUPLINGS
POLARSEAL COUPLINGS (ACA)
<b>POLARSEAL II COUPLINGS (ACC)</b>
POLARSEAL II COUPLINGS (ACB)
POWER STEERING
ADAPTERS
QUICK DISCONNECT COUPLERS
BALL VALVES
LIVE SWIVEL
ASSEMBLY FABRICATION
ACCESSORIES
EQUIPMENT AND PARTS
KITS
AIR BRAKE HOSE ASSY
BRASS



### Female SAE 45° Flare Swivel - Aluminum

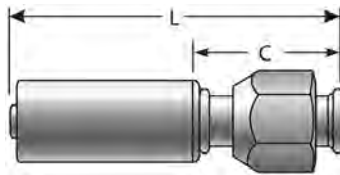

Part No.	Descr.	Prod. No.	⊖	🌀	L	C
			"	"	"	"
G47200-0606	6ACB-6FSX	7332-51435	1/3	5/8-18	2.88	1.38
G47200-0608	6ACB-8FSX	7332-51445	1/3	3/4-16	2.70	1.20
G47200-0806	8ACB-6FSX	7332-52335	2/5	5/8-18	2.69	1.19
G47200-0808	8ACB-8FSX	7332-51455	2/5	3/4-16	2.69	1.19
G47200-1008	10ACB-8FSX	7332-52345	1/2	3/4-16	3.00	1.50
G47200-1010	10ACB-10FSX	7332-51465	1/2	7/8-14	3.00	1.50
G47200-1212	12ACB-12FSX	7332-51475	5/8	1 1/16-14	3.25	1.75

### Female SAE 45° Flare Swivel - Steel

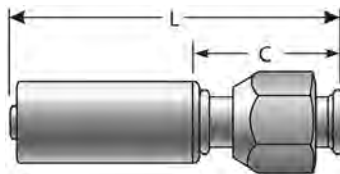

Part No.	Descr.	Prod. No.	⊖	🌀	L	C
			"	"	"	"
G47200-0606S	6ACB-6FSX-S	7332-20015	5/16	5/8-18	2.88	1.63
G47200-0808S	8ACB-8FSX-S	7332-20025	13/32	3/4-16	2.69	1.44
G47200-1210S	12ACB-10FSX-S	7332-20035	5/8	7/8-14	3.25	2.00

### Female SAE 45° Flare Swivel - 45° Bent Tube - Aluminum

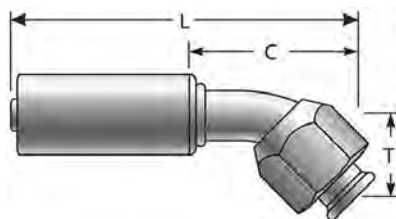

Part No.	Descr.	Prod. No.	⊖	🌀	T	L	C
			"	"	"	"	"
G47202-0606	6ACB-6FSX45	7332-51485	1/3	5/8-18	.56	2.84	1.34
G47202-0808	8ACB-8FSX45	7332-51495	2/5	3/4-16	.63	3.07	1.57
G47202-1010	10ACB-10FSX45	7332-51505	1/2	7/8-14	.88	3.63	2.13
G47202-1212	12ACB-12FSX45	7332-51515	5/8	1 1/16-14	1.00	4.00	2.50

EQUIPMENT
HOSE/CPLG. SELECTION
G8K COUPLINGS
GLOBALSPIRAL COUPLINGS
STAINLESS STEEL SPIRAL
MEGACRIMP COUPLINGS
STAINLESS STEEL BRAID
POWER CRIMP COUPLINGS
FIELD ATTACHABLE G1 & G2 COUPLINGS
FIELD ATTACHABLE C5 COUPLINGS
C14 COUPLINGS
GL COUPLINGS
GLX COUPLINGS
PCTS THERMOPLASTIC COUPLINGS
POLARSEAL COUPLINGS (ACA)
POLARSEAL II COUPLINGS (ACC)
POLARSEAL II COUPLINGS (ACB)
POWER STEERING
ADAPTERS
QUICK DISCONNECT COUPLERS
BALL VALVES
LIVE SWIVEL
ASSEMBLY FABRICATION
ACCESSORIES
EQUIPMENT AND PARTS
KITS
AIR BRAKE HOSE ASSY
BRASS

EQUIPMENT
HOSE/CPLG. SELECTION
G8K COUPLINGS
GLOBAL SPIRAL COUPLINGS
STAINLESS STEEL SPIRAL
MEGACRIMP COUPLINGS
STAINLESS STEEL BRAID
POWER CRIMP COUPLINGS
FIELD ATTACHABLE G1 & G2 COUPLINGS
FIELD ATTACHABLE C5 COUPLINGS
C14 COUPLINGS
GL COUPLINGS
GLX COUPLINGS
PCTS THERMOPLASTIC COUPLINGS
POLARSEAL COUPLINGS (ACA)
POLARSEAL II COUPLINGS (ACC)
<b>POLARSEAL II COUPLINGS (ACB)</b>
POWER STEERING
ADAPTERS
QUICK DISCONNECT COUPLERS
BALL VALVES
LIVE SWIVEL
ASSEMBLY FABRICATION
ACCESSORIES
EQUIPMENT AND PARTS
KITS
AIR BRAKE HOSE ASSY
BRASS

### Female SAE 45° Flare Swivel - 45° Bent Tube - Steel

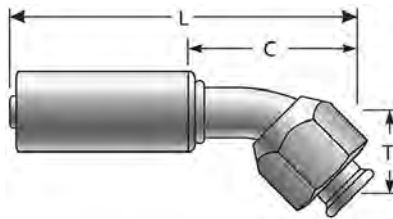

Part No.	Descr.	Prod. No.	⊖		T	L	C
			"	"	"	"	"
G47202-1008S	10ACB-8FSX45-S	7332-20045	1/2	3/4-16	.63	3.00	1.75

### Female SAE 45° Flare Swivel - 90° Bent Tube - Aluminum

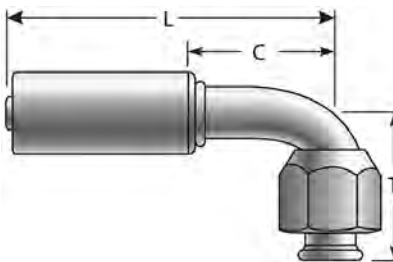

Part No.	Descr.	Prod. No.	⊖		T	L	C
			"	"	"	"	"
G47205-0606	6ACB-6FSX90	7332-51525	1/3	5/8-18	1.06	2.56	1.06
G47205-0808	8ACB-8FSX90	7332-51535	2/5	3/4-16	1.25	2.75	1.25
G47205-1010	10ACB-10FSX90	7332-51545	1/2	7/8-14	1.50	3.00	1.50
G47205-1210	12ACB-10FSX90	7332-51555	5/8	7/8-14	1.50	3.25	1.75
G47205-1212	12ACB-12FSX90	7332-51565	5/8	1 1/16-14	1.50	3.25	1.75

### Female SAE 45° Flare Swivel - 90° Bent Tube - Steel

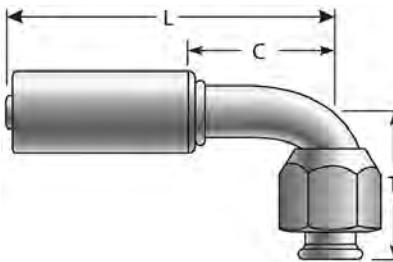

Part No.	Descr.	Prod. No.	⊖		T	L	C
			"	"	"	"	"
G47205-0606S	6ACB-6FSX90-S	7332-20055	5/16	5/8-18	1.06	2.56	1.31
G47205-0808S	8ACB-8FSX90-S	7332-20075	13/32	3/4-16	1.25	2.75	1.50



Female SAE 45° Flare Swivel - 90° Bent Tube - Steel - Continued

Part No.	Descr.	Prod. No.			T	L	C
			"	"			
G47205-1008S	10ACB-8FSX90-S	7332-20085	1/2	3/4-16	1.50	3.00	1.75
G47205-1010S	10ACB-10FSX90-S	7332-20095	1/2	7/8-14	1.50	3.00	1.75
G47205-1210S	12ACB-10FSX90-S	7332-20105	5/8	7/8-14	1.50	3.25	2.00
G47205-1212S	12ACB-12FSX90-S	7332-20115	5/8	1 1/16-14	1.50	3.85	2.00

Male SAE Flareless Assembly - Steel

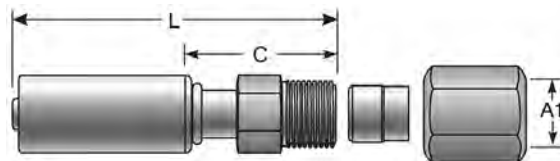

Part No.	Descr.	Prod. No.			A1	L	C
			"	"			
G47510-0606S	6ACB-6MFA-S	7332-51575	1/3	5/8-18	3/8	2.69	1.19
G47510-0608S	6ACB-8MFA-S	7332-20125	5/16	3/4-16	1/2	2.81	1.56
G47510-0806S	8ACB-6MFA-S	7332-20135	13/32	9/16-18	3/8	2.75	1.50
G47510-0808S	8ACB-8MFA-S	7332-20145	13/32	3/4-16	1/2	2.88	1.63
G47510-0810S	8ACB-10MFA-S	7332-20155	13/32	7/8-14	5/8	3.00	1.75
G47510-1008S	10ACB-8MFA-S	7332-20165	1/2	3/4-16	1/2	2.94	1.69
G47510-1010S	10ACB-10MFA-S	7332-20175	1/2	7/8-14	5/8	3.00	1.75
G47510-1210S	12ACB-10MFA-S	7332-20185	5/8	7/8-14	5/8	3.13	1.88
G47510-1212S	12ACB-12MFA-S	7332-20195	5/8	1 1/16-12	3/4	3.25	2.00

Male SAE Flareless Assembly - 90° Block - Steel

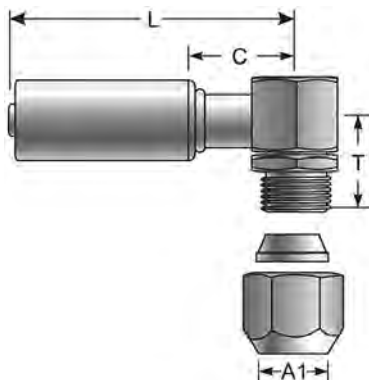

Part No.	Descr.	Prod. No.			A1	T	L	C
			"	"				
G47511-0606S	6ACB-6MFA90-S	7332-20205	5/16	9/16-18	3/8	.78	2.24	.99
G47511-0608S	6ACB-8MFA90-S	7332-20215	5/16	3/4-16	1/2	.96	2.31	1.06
G47511-0808S	8ACB-8MFA90-S	7332-20225	13/32	3/4-16	1/2	.96	2.37	1.12

EQUIPMENT
HOSE/CPLG. SELECTION
G8K COUPLINGS
GLOBAL SPIRAL COUPLINGS
STAINLESS STEEL SPIRAL
MEGACRIMP COUPLINGS
STAINLESS STEEL BRAID
POWER CRIMP COUPLINGS
FIELD ATTACHABLE G1 & G2 COUPLINGS
FIELD ATTACHABLE C5 COUPLINGS
C14 COUPLINGS
GL COUPLINGS
GLX COUPLINGS
PCTS THERMOPLASTIC COUPLINGS
POLARSEAL COUPLINGS (ACA)
POLARSEAL II COUPLINGS (ACC)
<b>POLARSEAL II COUPLINGS (ACB)</b>
POWER STEERING
ADAPTERS
QUICK DISCONNECT COUPLERS
BALL VALVES
LIVE SWIVEL
ASSEMBLY FABRICATION
ACCESSORIES
EQUIPMENT AND PARTS
KITS
AIR BRAKE HOSE ASSY
BRASS



EQUIPMENT
HOSE/CPLG. SELECTION
G8K COUPLINGS
GLOBAL SPIRAL COUPLINGS
STAINLESS STEEL SPIRAL
MEGACRIMP COUPLINGS
STAINLESS STEEL BRAID
POWER CRIMP COUPLINGS
FIELD ATTACHABLE G1 & G2 COUPLINGS
FIELD ATTACHABLE C5 COUPLINGS
C14 COUPLINGS
GL COUPLINGS
GLX COUPLINGS
PCTS THERMOPLASTIC COUPLINGS
POLARSEAL COUPLINGS (ACA)
POLARSEAL II COUPLINGS (ACC)
POLARSEAL II COUPLINGS (ACB)
POWER STEERING
ADAPTERS
QUICK DISCONNECT COUPLERS
BALL VALVES
LIVE SWIVEL
ASSEMBLY FABRICATION
ACCESSORIES
EQUIPMENT AND PARTS
KITS
AIR BRAKE HOSE ASSY
BRASS

### Male SAE Flareless Assembly - 90° Block - Steel - Continued

Part No.	Descr.	Prod. No.			A1	T	L	C
			"	"				
G47511-0810S	8ACB-10MFA90-S	7332-20235	13/32	7/8-14	5/8	1.08	2.43	1.18
G47511-1008S	10ACB-8MFA90-S	7332-20245	1/2	3/4-16	1/2	.96	2.38	1.13
G47511-1010S	10ACB-10MFA90-S	7332-20255	1/2	7/8-14	5/8	1.08	2.44	1.19
G47511-1210S	12ACB-10MFA90-S	7332-20265	5/8	7/8-14	5/8	1.08	2.56	1.31
G47511-1212S	12ACB-12MFA90-S	7332-20275	5/8	1 1/16-12	3/4	1.19	2.66	1.41

### Female Braze-On Stems - Aluminum

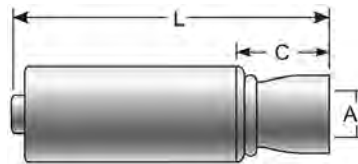

Part No.	Descr.	Prod. No.		A1	L	C
			"			
G47527-0606	6ACB-6FBO	7332-52355	1/3	3/8	2.10	.60
G47527-0808	8ACB-8FBO	7332-52365	2/5	1/2	2.10	.60
G47527-1010	10ACB-10FBO	7332-52375	1/2	5/8	2.10	.60
G47527-1210	12ACB-10FBO	7332-52385	5/8	5/8	2.10	.60
G47527-1212	12ACB-12FBO	7332-52395	5/8	3/4	2.10	.60

### Female Braze-On Stems - Steel

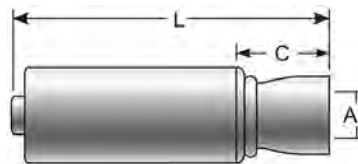

Part No.	Descr.	Prod. No.		A1	L	C
			"			
G47527-0606S	6ACB-6FBO-S	7332-20285	5/16	3/8	2.10	.85
G47527-0808S	8ACB-8FBO-S	7332-20295	13/32	1/2	2.10	.85
G47527-1010S	10ACB-10FBO-S	7332-20305	1/2	5/8	2.10	.85
G47527-1210S	12ACB-10FBO-S	7332-20315	5/8	5/8	2.10	.85
G47527-1212S	12ACB-12FBO-S	7332-20325	5/8	3/4	2.10	.85





### Hose Length Extender - Aluminum

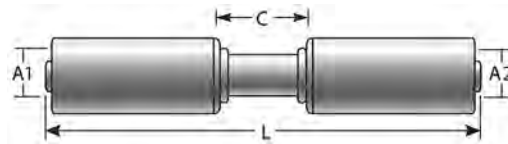

Part No.	Descr.	Prod. No.	⊖	A1	A2	L	C
			"	"	"	"	"
G47535-0606	6ACB-6HLE	7332-52135	1/3	5/16	5/16	4.50	1.50
G47535-0608	6ACB-8HLE	7332-52145	1/3, 2/5	5/16	13/32	4.50	1.50
G47535-0808	8ACB-8HLE	7332-52155	2/5	13/32	13/32	4.50	1.50
G47535-0810	8ACB-10HLE	7332-52165	2/5, 1/2	13/32	1/2	4.63	1.63
G47535-1010	10ACB-10HLE	7332-52175	1/2	1/2	1/2	4.63	1.63
G47535-1210	12ACB-10HLE	7332-52405	1/2, 5/8	5/8	1/2	4.75	1.75
G47535-1212	12ACB-12HLE	7332-52185	5/8	5/8	5/8	4.75	1.75

### Hose Length Extender - Steel

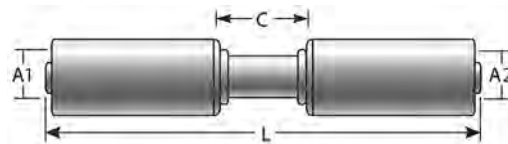

Part No.	Descr.	Prod. No.	⊖	A1	A2	L	C
			"	"	"	"	"
G47535-0606S	6ACB-6HLE-S	7332-20335	5/16	5/16	5/16	4.00	1.50
G47535-0608S	6ACB-8HLE-S	7332-20345	5/16	5/16	13/32	4.00	1.50
G47535-0808S	8ACB-8HLE-S	7332-20355	13/32	13/32	13/32	4.00	1.50
G47535-0810S	8ACB-10HLE-S	7332-20365	13/32	13/32	1/2	4.13	1.63
G47535-1010S	10ACB-10HLE-S	7332-20375	1/2	1/2	1/2	4.13	1.63
G47535-1210S	12ACB-10HLE-S	7332-20385	5/8	5/8	1/2	4.25	1.75
G47535-1212S	12ACB-12HLE-S	7332-20395	5/8	5/8	5/8	4.25	1.75

- EQUIPMENT
- HOSE/CPLG. SELECTION
- G8K COUPLINGS
- GLOBALSPIRAL COUPLINGS
- STAINLESS STEEL SPIRAL
- MEGACRIMP COUPLINGS
- STAINLESS STEEL BRAID
- POWER CRIMP COUPLINGS
- FIELD ATTACHABLE G1 & G2 COUPLINGS
- FIELD ATTACHABLE C5 COUPLINGS
- C14 COUPLINGS
- GL COUPLINGS
- GLX COUPLINGS
- PCTS THERMOPLASTIC COUPLINGS
- POLARSEAL COUPLINGS (ACA)
- POLARSEAL II COUPLINGS (ACC)
- POLARSEAL II COUPLINGS (ACB)**
- POWER STEERING
- ADAPTERS
- QUICK DISCONNECT COUPLERS
- BALL VALVES
- LIVE SWIVEL
- ASSEMBLY FABRICATION
- ACCESSORIES
- EQUIPMENT AND PARTS
- KITS
- AIR BRAKE HOSE ASSY
- BRASS



EQUIPMENT
HOSE/CPLG. SELECTION
G8K COUPLINGS
GLOBAL SPIRAL COUPLINGS
STAINLESS STEEL SPIRAL
MEGACRIMP COUPLINGS
STAINLESS STEEL BRAID
POWER CRIMP COUPLINGS
FIELD ATTACHABLE G1 & G2 COUPLINGS
FIELD ATTACHABLE C5 COUPLINGS
C14 COUPLINGS
GL COUPLINGS
GLX COUPLINGS
PCTS THERMOPLASTIC COUPLINGS
POLARSEAL COUPLINGS (ACA)
POLARSEAL II COUPLINGS (ACC)
POLARSEAL II COUPLINGS (ACB)
POWER STEERING
ADAPTERS
QUICK DISCONNECT COUPLERS
BALL VALVES
LIVE SWIVEL
ASSEMBLY FABRICATION
ACCESSORIES
EQUIPMENT AND PARTS
KITS
AIR BRAKE HOSE ASSY
BRASS

### Hose Length Extender - 90° Bent Tube - Steel

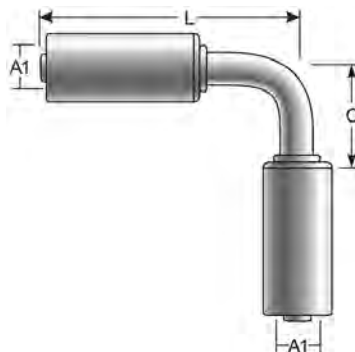

Part No.	Descr.	Prod. No.	⊖	A1	L	C
			"	"	"	"
G47537-0606S	6ACB-6HLE90-S	7332-20405	5/16	5/16	2.50	1.25
G47537-0808S	8ACB-8HLE90-S	7332-52765	2/5	1/2	2.87	1.37
G47537-1010S	10ACB-10HLE90-S	7332-20415	1/2	1/2	2.88	1.63
G47537-1212S	12ACB-12HLE90-S	7332-20425	5/8	5/8	3.25	2.00

### Hose Length Extender with Sight Glass - Steel

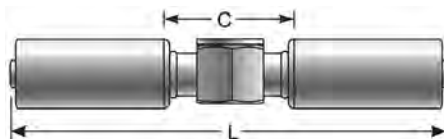

Part No.	Descr.	Prod. No.	⊖	L	C
			"	"	"
G47538-0606S	6ACB-6HLESG-S	7332-20435	5/16	4.12	1.62



### Hose Length Extender - Tee - Aluminum

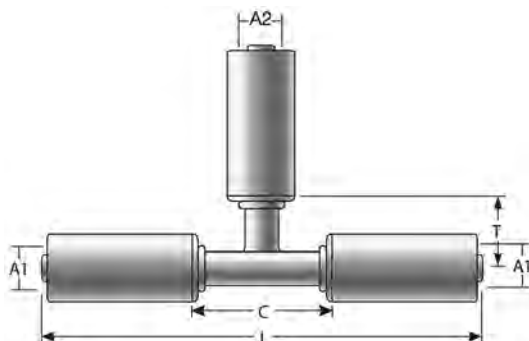

Part No.	Descr.	Prod. No.	⊖	A1	A2	T	L	C
			"					
G47539-0606	6ACB-6HLET	7332-52305	1/3	5/16	5/16	.94	4.75	1.75
G47539-1010	10ACB-10HLET	7332-52315	1/2	1/2	1/2	1.00	5.00	2.00
G47539-1212	12ACB-12HLET	7332-52325	5/8	5/8	5/8	1.12	5.25	2.25

### Hose Length Extender - Tee - Steel

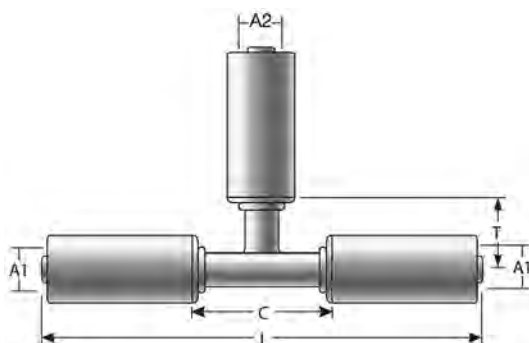

Part No.	Descr.	Prod. No.	⊖	A1	A2	T	L	C
			"					
G47539-0606S	6ACB-6HLET-S	7332-20445	5/16	5/16	5/16	1.13	4.75	2.25
G47539-0808S	8ACB-8HLET-S	7332-20455	13/32	13/32	13/32	1.19	4.88	2.38
G47539-1010S	10ACB-10HLET-S	7332-20465	1/2	1/2	1/2	1.25	5.00	2.50
G47539-1212S	12ACB-12HLET-S	7332-20475	5/8	5/8	5/8	1.37	5.25	2.75

EQUIPMENT
HOSE/CPLG. SELECTION
G8K COUPLINGS
GLOBALSPIRAL COUPLINGS
STAINLESS STEEL SPIRAL
MEGACRIMP COUPLINGS
STAINLESS STEEL BRAID
POWER CRIMP COUPLINGS
FIELD ATTACHABLE G1 & G2 COUPLINGS
FIELD ATTACHABLE C5 COUPLINGS
C14 COUPLINGS
GL COUPLINGS
GLX COUPLINGS
PCTS THERMOPLASTIC COUPLINGS
POLARSEAL COUPLINGS (ACA)
POLARSEAL II COUPLINGS (ACC)
POLARSEAL II COUPLINGS (ACB)
POWER STEERING
ADAPTERS
QUICK DISCONNECT COUPLERS
BALL VALVES
LIVE SWIVEL
ASSEMBLY FABRICATION
ACCESSORIES
EQUIPMENT AND PARTS
KITS
AIR BRAKE HOSE ASSY
BRASS



EQUIPMENT
HOSE/CPLG. SELECTION
G8K COUPLINGS
GLOBALSPIRAL COUPLINGS
STAINLESS STEEL SPIRAL
MEGACRIMP COUPLINGS
STAINLESS STEEL BRAID
POWER CRIMP COUPLINGS
FIELD ATTACHABLE G1 & G2 COUPLINGS
FIELD ATTACHABLE C5 COUPLINGS
C14 COUPLINGS
GL COUPLINGS
GLX COUPLINGS
PCTS THERMOPLASTIC COUPLINGS
POLARSEAL COUPLINGS (ACA)
POLARSEAL II COUPLINGS (ACC)
POLARSEAL II COUPLINGS (ACB)
POWER STEERING
ADAPTERS
QUICK DISCONNECT COUPLERS
BALL VALVES
LIVE SWIVEL
ASSEMBLY FABRICATION
ACCESSORIES
EQUIPMENT AND PARTS
KITS
AIR BRAKE HOSE ASSY
BRASS

## Female O-Ring with R134 Service Port - 45° Bent Tube - Aluminum

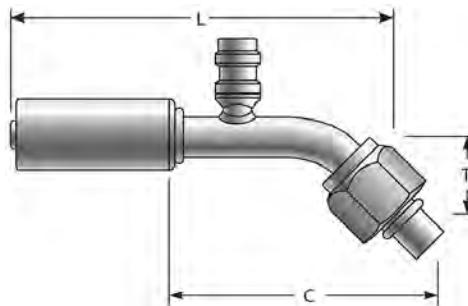

Part No.	Descr.	Prod. No.	⊖	🌀	T	L	C
			"	"	"	"	"
G47576-0808	8ACB-8FTON134SP45	7332-52745	2/5	3/4-16	.63	3.76	2.26
G47576-1010	10ACB-10FTON134SP45	7332-52775	1/2	7/8-14	.88	4.13	2.63

## Female O-Ring with R134 Service Port - 45° Bent Tube - Steel

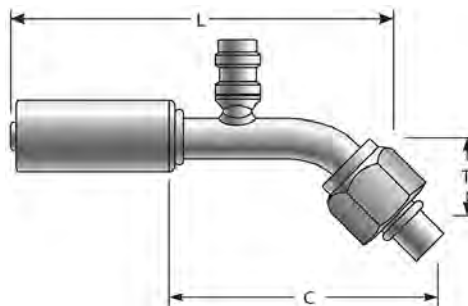

Part No.	Descr.	Prod. No.	⊖	🌀	T	L	C
			"	"	"	"	"
G47576-0606S	6ACB-6FTON134SP45-S	7332-52735	1/3	5/8-18	.56	3.69	2.19
G47576-0808S	8ACB-8FTON134SP45-S	7332-52695	2/5	3/4-16	.63	3.76	2.26
G47576-1010S	10ACB-10FTON134SP45-S	7332-52705	1/2	7/8-14	.88	4.13	2.63
G47576-1210S	12ACB-10FTON134SP45-S	7332-52715	5/8	7/8-14	.94	4.32	2.62



### Female O-Ring with R12 Service Port - 45° Bent Tube - Steel

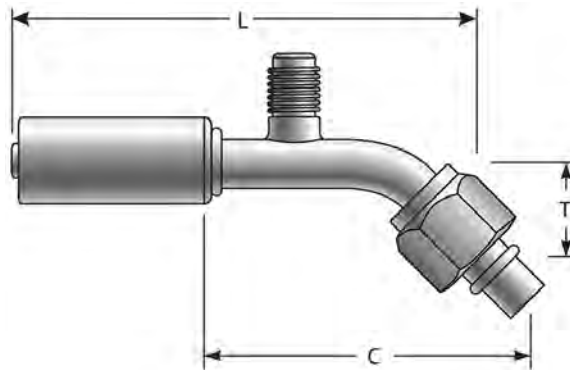

Part No.	Descr.	Prod. No.			T	L	C
			"	"			
G47577-0606S	6ACB-6FTONR12SP45-S	7332-52785	1/3	5/8-18	.56	3.69	2.19
G47577-0808S	8ACB-8FTONR12SP45-S	7332-52795	2/5	3/4-16	.63	3.76	2.26
G47577-1010S	10ACB-10FTONR12SP45-S	7332-52805	1/2	7/8-14	.88	4.13	2.63

### Male SAE Tube O-Ring Nut Swivel with R134a Service Port - Steel

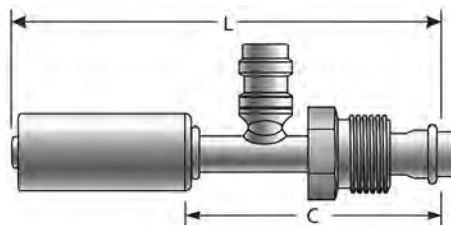

Part No.	Descr.	Prod. No.			L	C
			"	"		
G47580-0606S	6ACB-6MTON134SP-S	7332-20485	5/16	5/8-18	3.35	2.10
G47580-1010S	10ACB-10MTON134SP-S	7332-20495	1/2	7/8-14	3.59	2.34

EQUIPMENT
HOSE/CPLG. SELECTION
G8K COUPLINGS
GLOBALSPIRAL COUPLINGS
STAINLESS STEEL SPIRAL
MEGACRIMP COUPLINGS
STAINLESS STEEL BRAID
POWER CRIMP COUPLINGS
FIELD ATTACHABLE G1 & G2 COUPLINGS
FIELD ATTACHABLE C5 COUPLINGS
C14 COUPLINGS
GL COUPLINGS
GLX COUPLINGS
PCTS THERMOPLASTIC COUPLINGS
POLARSEAL COUPLINGS (ACA)
POLARSEAL II COUPLINGS (ACC)
POLARSEAL II COUPLINGS (ACB)
POWER STEERING
ADAPTERS
QUICK DISCONNECT COUPLERS
BALL VALVES
LIVE SWIVEL
ASSEMBLY FABRICATION
ACCESSORIES
EQUIPMENT AND PARTS
KITS
AIR BRAKE HOSE ASSY
BRASS



EQUIPMENT
HOSE/CPLG. SELECTION
G8K COUPLINGS
GLOBAL SPIRAL COUPLINGS
STAINLESS STEEL SPIRAL
MEGACRIMP COUPLINGS
STAINLESS STEEL BRAID
POWER CRIMP COUPLINGS
FIELD ATTACHABLE G1 & G2 COUPLINGS
FIELD ATTACHABLE C5 COUPLINGS
C14 COUPLINGS
GL COUPLINGS
GLX COUPLINGS
PCTS THERMOPLASTIC COUPLINGS
POLARSEAL COUPLINGS (ACA)
POLARSEAL II COUPLINGS (ACC)
POLARSEAL II COUPLINGS (ACB)
POWER STEERING
ADAPTERS
QUICK DISCONNECT COUPLERS
BALL VALVES
LIVE SWIVEL
ASSEMBLY FABRICATION
ACCESSORIES
EQUIPMENT AND PARTS
KITS
AIR BRAKE HOSE ASSY
BRASS

## Male SAE Tube O-Ring Nut Swivel with R134a Service Port - 90° Bent Tube - Steel

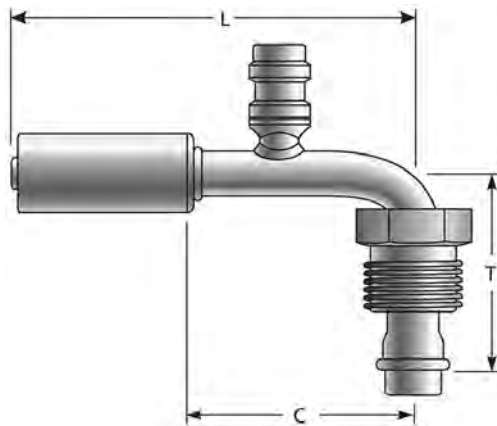

Part No.	Descr.	Prod. No.	⊖	🌀	T	L	C
			"	"	"	"	"
G47582-1010S	10ACB-10MTON134SP90-S	7332-20505	1/2	7/8-14	1.50	3.85	2.60

## Male SAE Tube O-Ring Nut Swivel - Aluminum

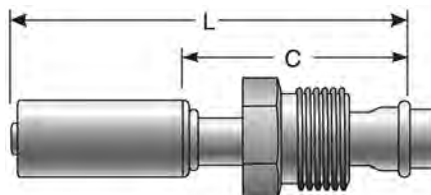

Part No.	Descr.	Prod. No.	⊖	🌀	L	C
			"	"	"	"
G47583-0606	6ACB-6MTON	7332-51585	1/3	5/8-18	3.19	1.69
G47583-0806	8ACB-6MTON	7332-52415	2/5	5/8-18	3.25	1.75
G47583-0808	8ACB-8MTON	7332-51595	2/5	3/4-18	3.25	1.75
G47583-1010	10ACB-10MTON	7332-51605	1/2	7/8-18	3.38	1.88
G47583-1210	12ACB-10MTON	7332-52425	5/8	7/8-18	3.88	2.38
G47583-1212	12ACB-12MTON	7332-51615	5/8	1 1/16-16	3.88	2.38



### Male SAE Tube O-Ring Nut Swivel - Steel

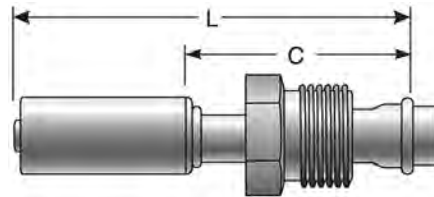

Part No.	Descr.	Prod. No.			L	C
			"	"		
G47583-0606S	6ACB-6MTON-S	7332-20515	5/16	5/8-18	3.19	1.94
G47583-0607S	6ACB-7MTON-S	7332-20525	5/16	11/16-16	3.00	1.75
G47583-0806S	8ACB-6MTON-S	7332-20535	13/32	5/8-18	3.25	2.00
G47583-0808S	8ACB-8MTON-S	7332-20545	13/32	3/4-16	3.25	2.00
G47583-1008S	10ACB-8MTON-S	7332-52815	1/2	3/4-18	3.38	1.88
G47583-1010S	10ACB-10MTON-S	7332-20555	1/2	7/8-14	3.38	2.13
G47583-1210S	12ACB-10MTON-S	7332-20565	5/8	7/8-14	3.88	2.63
G47583-1212S	12ACB-12MTON-S	7332-20575	5/8	1 1/16-14	3.88	2.63

### Male SAE Tube O-Ring Nut - 45° Bent Tube - Aluminum

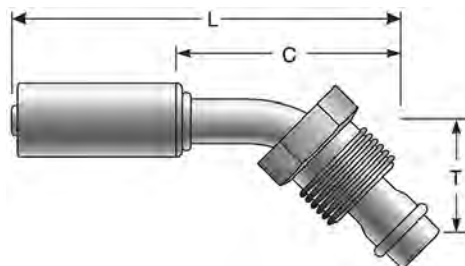

Part No.	Descr.	Prod. No.			T	L	C
			"	"			
G47584-0606	6ACB-6MTON45	7332-51625	1/3	5/8-18	.88	3.19	1.69
G47584-0808	8ACB-8MTON45	7332-51635	2/5	3/4-18	1.00	3.44	1.94
G47584-1010	10ACB-10MTON45	7332-51645	1/2	7/8-18	.88	3.63	2.13
G47584-1212	12ACB-12MTON45	7332-51655	5/8	1 1/16-16	1.19	4.19	2.69

- EQUIPMENT
- HOSE/CPLG. SELECTION
- G8K COUPLINGS
- GLOBALSPIRAL COUPLINGS
- STAINLESS STEEL SPIRAL
- MEGACRIMP COUPLINGS
- STAINLESS STEEL BRAID
- POWER CRIMP COUPLINGS
- FIELD ATTACHABLE G1 & G2 COUPLINGS
- FIELD ATTACHABLE C5 COUPLINGS
- C14 COUPLINGS
- GL COUPLINGS
- GLX COUPLINGS
- PCTS THERMOPLASTIC COUPLINGS
- POLARSEAL COUPLINGS (ACA)
- POLARSEAL II COUPLINGS (ACC)
- POLARSEAL II COUPLINGS (ACB)
- POWER STEERING
- ADAPTERS
- QUICK DISCONNECT COUPLERS
- BALL VALVES
- LIVE SWIVEL
- ASSEMBLY FABRICATION
- ACCESSORIES
- EQUIPMENT AND PARTS
- KITS
- AIR BRAKE HOSE ASSY
- BRASS





EQUIPMENT
HOSE/CPLG. SELECTION
G8K COUPLINGS
GLOBAL SPIRAL COUPLINGS
STAINLESS STEEL SPIRAL
MEGACRIMP COUPLINGS
STAINLESS STEEL BRAID
POWER CRIMP COUPLINGS
FIELD ATTACHABLE G1 & G2 COUPLINGS
FIELD ATTACHABLE C5 COUPLINGS
C14 COUPLINGS
GL COUPLINGS
GLX COUPLINGS
PCTS THERMOPLASTIC COUPLINGS
POLARSEAL COUPLINGS (ACA)
POLARSEAL II COUPLINGS (ACC)
POLARSEAL II COUPLINGS (ACB)
POWER STEERING
ADAPTERS
QUICK DISCONNECT COUPLERS
BALL VALVES
LIVE SWIVEL
ASSEMBLY FABRICATION
ACCESSORIES
EQUIPMENT AND PARTS
KITS
AIR BRAKE HOSE ASSY
BRASS

### Male SAE Tube O-Ring Nut - 45° Bent Tube - Steel

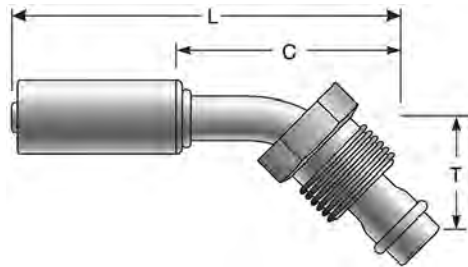

Part No.	Descr.	Prod. No.	⊖		T	L	C
			"	"	"	"	"
G47584-0606S	6ACB-6MTON45-S	7332-20585	5/16	5/8-18	.88	3.19	1.94
G47584-0806S	8ACB-6MTON45-S	7332-20595	13/32	5/8-18	1.00	3.47	2.22
G47584-0808S	8ACB-8MTON45-S	7332-20605	13/32	3/4-16	1.00	3.44	2.19
G47584-1010S	10ACB-10MTON45-S	7332-20615	1/2	7/8-14	1.06	3.81	2.56
G47584-1212S	12ACB-12MTON45-S	7332-20625	5/8	1 1/16-14	1.19	4.19	2.94

### Male SAE Tube O-Ring Nut - 90° Bent Tube - Aluminum

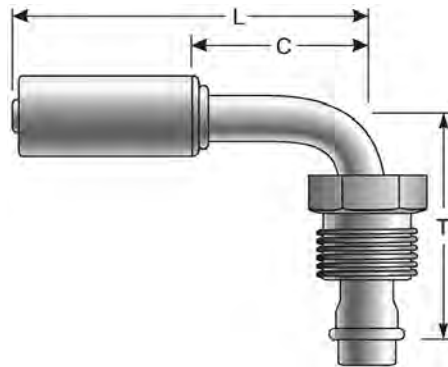

Part No.	Descr.	Prod. No.	⊖		T	L	C
			"	"	"	"	"
G47585-0606	6ACB-6MTON90	7332-51665	1/3	5/8-18	1.63	2.56	1.06
G47585-0806	8ACB-6MTON90	7332-52435	2/5	5/8-18	1.88	2.75	1.25
G47585-0808	8ACB-8MTON90	7332-51675	2/5	3/4-18	1.88	2.75	1.25
G47585-1010	10ACB-10MTON90	7332-51685	1/2	7/8-18	2.12	3.00	1.50
G47585-1210	12ACB-10MTON90	7332-52445	5/8	7/8-18	2.25	3.25	1.75
G47585-1212	12ACB-12MTON90	7332-51695	5/8	1 1/16-16	2.25	3.25	1.75



### Male SAE Tube O-Ring Nut - 90° Bent Tube - Steel

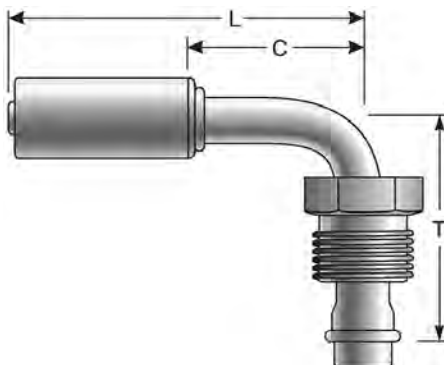

Part No.	Descr.	Prod. No.	⊖	🌀	T	L	C
			"	"	"	"	"
G47585-0606S	6ACB-6MTON90-S	7332-20635	5/16	5/8-18	1.63	2.56	1.31
G47585-0607S	6ACB-7MTON90-S	7332-20645	5/16	11/16-16	1.56	2.56	1.31
G47585-0806S	8ACB-6MTON90-S	7332-20655	13/32	5/8-18	1.88	2.75	1.50
G47585-0808S	8ACB-8MTON90-S	7332-20665	13/32	3/4-16	1.88	2.75	1.50
G47585-1010S	10ACB-10MTON90-S	7332-20675	1/2	7/8-14	2.12	3.00	1.75
G47585-1210S	12ACB-10MTON90-S	7332-20685	5/8	7/8-14	2.25	3.25	2.00
G47585-1212S	12ACB-12MTON90-S	7332-20695	5/8	1 1/16-14	2.25	3.25	2.00

### Female SAE Tube O-Ring Nut Swivel with R12 Service Port - Aluminum

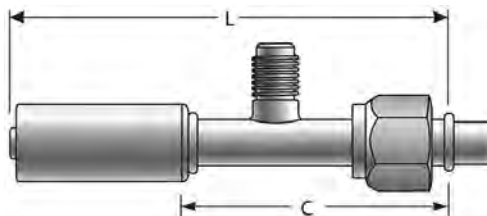

Part No.	Descr.	Prod. No.	⊖	🌀	L	C
			"	"	"	"
G47586-0808	8ACB-8FTONR12SP	7332-52235	2/5	3/4-16	3.38	1.88

EQUIPMENT
HOSE/CPLG. SELECTION
G8K COUPLINGS
GLOBALSPIRAL COUPLINGS
STAINLESS STEEL SPIRAL
MEGACRIMP COUPLINGS
STAINLESS STEEL BRAID
POWER CRIMP COUPLINGS
FIELD ATTACHABLE G1 & G2 COUPLINGS
FIELD ATTACHABLE C5 COUPLINGS
C14 COUPLINGS
GL COUPLINGS
GLX COUPLINGS
PCTS THERMOPLASTIC COUPLINGS
POLARSEAL COUPLINGS (ACA)
POLARSEAL II COUPLINGS (ACC)
POLARSEAL II COUPLINGS (ACB)
POWER STEERING
ADAPTERS
QUICK DISCONNECT COUPLERS
BALL VALVES
LIVE SWIVEL
ASSEMBLY FABRICATION
ACCESSORIES
EQUIPMENT AND PARTS
KITS
AIR BRAKE HOSE ASSY
BRASS



EQUIPMENT
HOSE/CPLG. SELECTION
G8K COUPLINGS
GLOBAL SPIRAL COUPLINGS
STAINLESS STEEL SPIRAL
MEGACRIMP COUPLINGS
STAINLESS STEEL BRAID
POWER CRIMP COUPLINGS
FIELD ATTACHABLE G1 & G2 COUPLINGS
FIELD ATTACHABLE C5 COUPLINGS
C14 COUPLINGS
GL COUPLINGS
GLX COUPLINGS
PCTS THERMOPLASTIC COUPLINGS
POLARSEAL COUPLINGS (ACA)
POLARSEAL II COUPLINGS (ACC)
POLARSEAL II COUPLINGS (ACB)
POWER STEERING
ADAPTERS
QUICK DISCONNECT COUPLERS
BALL VALVES
LIVE SWIVEL
ASSEMBLY FABRICATION
ACCESSORIES
EQUIPMENT AND PARTS
KITS
AIR BRAKE HOSE ASSY
BRASS

### Female SAE Tube O-Ring Nut Swivel with R12 Service Port - Steel

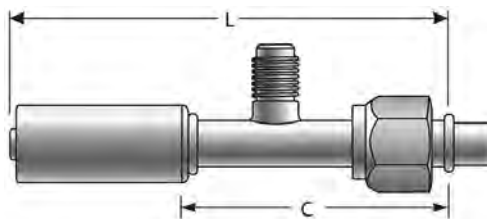

Part No.	Descr.	Prod. No.	⊖		L	C
			"	"	"	"
G47586-0606S	6ACB-6FTONR12SP-S	7332-20705	5/16	5/8-18	3.38	2.13
G47586-0808S	8ACB-8FTONR12SP-S	7332-20715	13/32	3/4-16	3.38	2.13
G47586-1010S	10ACB-10FTONR12SP-S	7332-20725	1/2	7/8-14	3.62	2.37

### Female SAE Tube O-Ring Nut Swivel with R12 Service Port - 90° Bent Tube - Aluminum

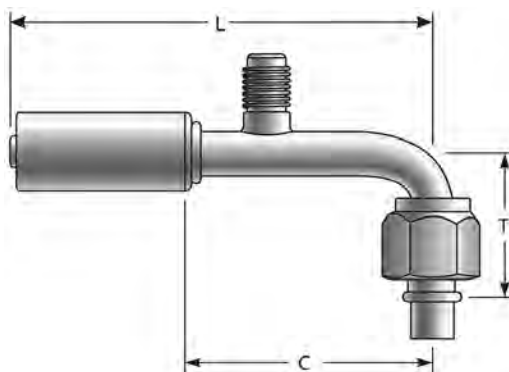

Part No.	Descr.	Prod. No.	⊖		T	L	C
			"	"	"	"	"
G47587-0606	6ACB-6FTONR12SP90	7332-52245	1/3	5/8-18	1.12	3.62	2.12



### Female SAE Tube O-Ring Nut Swivel with R12 Service Port - 90° Bent Tube - Steel

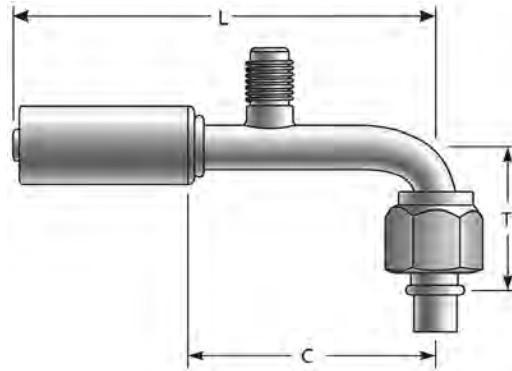

Part No.	Descr.	Prod. No.	⊖		T	L	C
			"	"			
G47587-0606S	6ACB-6FTONR12SP90-S	7332-20735	5/16	5/8-18	1.12	3.62	2.37
G47587-0808S	8ACB-8FTONR12SP90-S	7332-20745	13/32	3/4-16	1.31	3.62	2.37
G47587-1010S	10ACB-10FTONR12SP90-S	7332-20755	1/2	7/8-14	1.50	3.88	2.63
G47587-1210S	12ACB-10FTONR12SP90-S	7332-20765	5/8	7/8-14	1.75	4.19	2.94

### Female SAE Tube O-Ring Nut Swivel with R134a Service Port - Aluminum

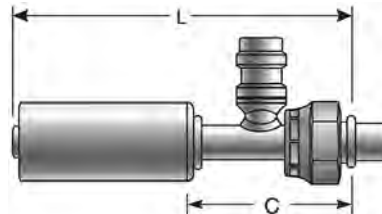

Part No.	Descr.	Prod. No.	⊖		L	C
			"	"		
G47588-0606	6ACB-6FTON134SP	7332-51705	1/3	5/8-18	3.38	1.88
G47588-0808	8ACB-8FTON134SP	7332-51715	2/5	3/4-16	3.38	1.88
G47588-1010	10ACB-10FTON134SP	7332-51725	1/2	7/8-14	3.62	2.12
G47588-1210	12ACB-10FTON134SP	7332-51735	5/8	7/8-14	3.75	2.25

EQUIPMENT
HOSE/CPLG. SELECTION
G8K COUPLINGS
GLOBALSPIRAL COUPLINGS
STAINLESS STEEL SPIRAL
MEGACRIMP COUPLINGS
STAINLESS STEEL BRAID
POWER CRIMP COUPLINGS
FIELD ATTACHABLE G1 & G2 COUPLINGS
FIELD ATTACHABLE C5 COUPLINGS
C14 COUPLINGS
GL COUPLINGS
GLX COUPLINGS
PCTS THERMOPLASTIC COUPLINGS
POLARSEAL COUPLINGS (ACA)
POLARSEAL II COUPLINGS (ACC)
POLARSEAL II COUPLINGS (ACB)
POWER STEERING
ADAPTERS
QUICK DISCONNECT COUPLERS
BALL VALVES
LIVE SWIVEL
ASSEMBLY FABRICATION
ACCESSORIES
EQUIPMENT AND PARTS
KITS
AIR BRAKE HOSE ASSY
BRASS



EQUIPMENT
HOSE/CPLG. SELECTION
G8K COUPLINGS
GLOBAL SPIRAL COUPLINGS
STAINLESS STEEL SPIRAL
MEGACRIMP COUPLINGS
STAINLESS STEEL BRAID
POWER CRIMP COUPLINGS
FIELD ATTACHABLE G1 & G2 COUPLINGS
FIELD ATTACHABLE C5 COUPLINGS
C14 COUPLINGS
GL COUPLINGS
GLX COUPLINGS
PCTS THERMOPLASTIC COUPLINGS
POLARSEAL COUPLINGS (ACA)
POLARSEAL II COUPLINGS (ACC)
POLARSEAL II COUPLINGS (ACB)
POWER STEERING
ADAPTERS
QUICK DISCONNECT COUPLERS
BALL VALVES
LIVE SWIVEL
ASSEMBLY FABRICATION
ACCESSORIES
EQUIPMENT AND PARTS
KITS
AIR BRAKE HOSE ASSY
BRASS

## Female SAE Tube O-Ring Nut Swivel with R134a Service Port - Steel

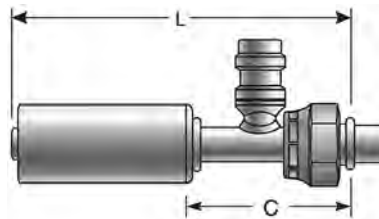

Part No.	Descr.	Prod. No.	⊖		L	C
			"	"	"	"
G47588-0606S	6ACB-6FTON134SP-S	7332-20775	5/16	5/8-18	3.30	2.05
G47588-0808S	8ACB-8FTON134SP-S	7332-20785	13/32	3/4-16	3.38	2.13
G47588-1010S	10ACB-10FTON134SP-S	7332-20795	1/2	7/8-14	3.62	2.37
G47588-1210S	12ACB-10FTON134SP-S	7332-20805	5/8	7/8-14	3.75	2.50
G47588-1212S	12ACB-12FTON134SP-S	7332-52725	5/8	1 1/16-14	3.75	2.25

## Female SAE Tube O-Ring Nut Swivel with R134a Service Port - 90° Bent Tube - Aluminum

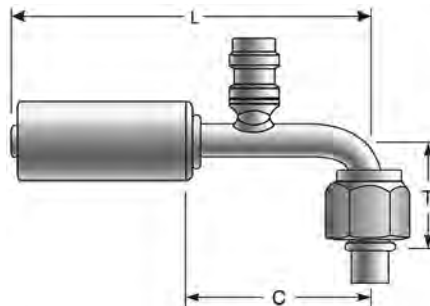

Part No.	Descr.	Prod. No.	⊖		T	L	C
			"	"	"	"	"
G47589-0606	6ACB-6FTON134SP90	7332-51745	1/3	5/8-18	1.12	3.62	2.12
G47589-0808	8ACB-8FTON134SP90	7332-51755	2/5	3/4-16	1.31	3.62	2.12
G47589-1010	10ACB-10FTON134SP90	7332-51765	1/2	7/8-14	1.50	3.88	2.38
G47589-1210	12ACB-10FTON134SP90	7332-51775	5/8	7/8-14	1.75	4.19	2.69



## Female SAE Tube O-Ring Nut Swivel with R134a Service Port - 90° Bent Tube - Steel

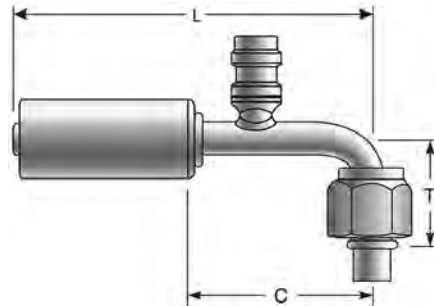

Part No.	Descr.	Prod. No.	⊖	🌀	T	L	C
			"	"	"	"	"
G47589-0606S	6ACB-6FTON134SP90-S	7332-20815	5/16	5/8-18	1.12	3.62	2.37
G47589-0808S	8ACB-8FTON134SP90-S	7332-20825	13/32	3/4-16	1.31	3.62	2.37
G47589-1010S	10ACB-10FTON134SP90-S	7332-20835	1/2	7/8-14	1.50	3.88	2.63
G47589-1210S	12ACB-10FTON134SP90-S	7332-20845	5/8	7/8-14	1.75	4.19	2.94

## Female SAE Tube O-Ring Nut Swivel - Aluminum

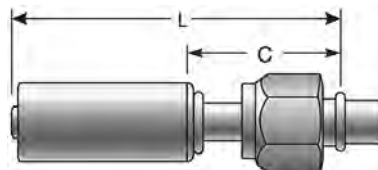

Part No.	Descr.	Prod. No.	⊖	🌀	L	C
			"	"	"	"
G47590-0606	6ACB-6FTON	7332-51785	1/3	5/8-18	2.88	1.38
G47590-0608	6ACB-8FTON	7332-51795	1/3	3/4-16	3.00	1.50
G47590-0806	8ACB-6FTON	7332-52465	2/5	5/8-18	3.00	1.50
G47590-0808	8ACB-8FTON	7332-51805	2/5	3/4-16	3.00	1.50
G47590-1008	10ACB-8FTON	7332-52195	1/2	3/4-16	3.19	1.69
G47590-1010	10ACB-10FTON	7332-51815	1/2	7/8-14	3.19	1.69
G47590-1012	10ACB-12FTON	7332-52205	1/2	1 1/16-14	3.31	1.81
G47590-1210	12ACB-10FTON	7332-51825	5/8	7/8-14	3.31	1.81
G47590-1212	12ACB-12FTON	7332-51835	5/8	1 1/16-14	3.31	1.81

- EQUIPMENT
- HOSE/CPLG. SELECTION
- G8K COUPLINGS
- GLOBALSPIRAL COUPLINGS
- STAINLESS STEEL SPIRAL
- MEGACRIMP COUPLINGS
- STAINLESS STEEL BRAID
- POWER CRIMP COUPLINGS
- FIELD ATTACHABLE G1 & G2 COUPLINGS
- FIELD ATTACHABLE C5 COUPLINGS
- C14 COUPLINGS
- GL COUPLINGS
- GLX COUPLINGS
- PCTS THERMOPLASTIC COUPLINGS
- POLARSEAL COUPLINGS (ACA)
- POLARSEAL II COUPLINGS (ACC)
- POLARSEAL II COUPLINGS (ACB)**
- POWER STEERING
- ADAPTERS
- QUICK DISCONNECT COUPLERS
- BALL VALVES
- LIVE SWIVEL
- ASSEMBLY FABRICATION
- ACCESSORIES
- EQUIPMENT AND PARTS
- KITS
- AIR BRAKE HOSE ASSY
- BRASS

EQUIPMENT
HOSE/CPLG. SELECTION
G8K COUPLINGS
GLOBAL SPIRAL COUPLINGS
STAINLESS STEEL SPIRAL
MEGACRIMP COUPLINGS
STAINLESS STEEL BRAID
POWER CRIMP COUPLINGS
FIELD ATTACHABLE G1 & G2 COUPLINGS
FIELD ATTACHABLE C5 COUPLINGS
C14 COUPLINGS
GL COUPLINGS
GLX COUPLINGS
PCTS THERMOPLASTIC COUPLINGS
POLARSEAL COUPLINGS (ACA)
POLARSEAL II COUPLINGS (ACC)
POLARSEAL II COUPLINGS (ACB)
POWER STEERING
ADAPTERS
QUICK DISCONNECT COUPLERS
BALL VALVES
LIVE SWIVEL
ASSEMBLY FABRICATION
ACCESSORIES
EQUIPMENT AND PARTS
KITS
AIR BRAKE HOSE ASSY
BRASS

## Female SAE Tube O-Ring Nut Swivel - Steel

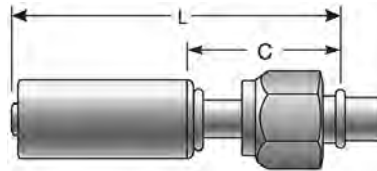

Part No.	Descr.	Prod. No.			L	C
			"	"	"	"
G47590-0606S	6ACB-6FTON-S	7332-20855	5/16	5/8-18	2.88	1.63
G47590-0608S	6ACB-8FTON-S	7332-20865	5/16	3/4-16	3.00	1.75
G47590-0806S	8ACB-6FTON-S	7332-20875	13/32	5/8-18	3.00	1.75
G47590-0808S	8ACB-8FTON-S	7332-20885	13/32	3/4-16	3.00	1.75
G47590-1008S	10ACB-8FTON-S	7332-20895	1/2	3/4-16	3.19	1.94
G47590-1010S	10ACB-10FTON-S	7332-20905	1/2	7/8-14	3.19	1.94
G47590-1012S	10ACB-12FTON-S	7332-20915	1/2	1 1/16-14	3.31	2.06
G47590-1210S	12ACB-10FTON-S	7332-20925	5/8	7/8-14	3.31	2.06
G47590-1212S	12ACB-12FTON-S	7332-20935	5/8	1 1/16-14	3.31	2.06

## Female SAE Tube O-Ring Nut Swivel - 45° Bent Tube - Aluminum

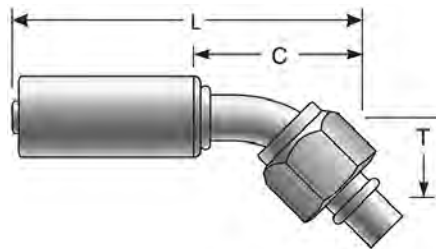

Part No.	Descr.	Prod. No.			T	L	C
			"	"	"	"	"
G47591-0606	6ACB-6FTON45	7332-51845	1/3	5/8-18	.63	2.87	1.37
G47591-0806	8ACB-6FTON45	7332-52475	2/5	5/8-18	.63	3.07	1.57
G47591-0808	8ACB-8FTON45	7332-51855	2/5	3/4-16	.63	3.07	1.57
G47591-1008	10ACB-8FTON45	7332-52485	1/2	3/4-16	.88	3.63	2.13
G47591-1010	10ACB-10FTON45	7332-51865	1/2	7/8-14	.88	3.63	2.13
G47591-1210	12ACB-10FTON45	7332-52495	5/8	7/8-14	.94	3.94	2.44
G47591-1212	12ACB-12FTON45	7332-51875	5/8	1 1/16-14	.94	3.94	2.44





### Female SAE Tube O-Ring Nut Swivel - 45° Bent Tube - Steel

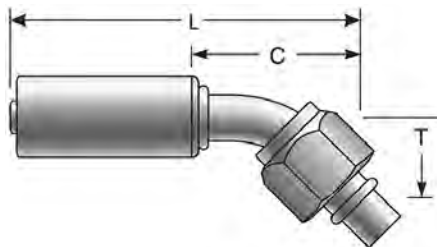

Part No.	Descr.	Prod. No.	⊖	🌀	T	L	C
			"	"	"	"	"
G47591-0606S	6ACB-6FTON45-S	7332-20945	5/16	5/8-18	.56	2.87	1.52
G47591-0806S	8ACB-6FTON45-S	7332-20955	13/32	5/8-18	.63	3.04	1.79
G47591-0808S	8ACB-8FTON45-S	7332-20965	13/32	3/4-16	.63	3.07	1.82
G47591-1008S	10ACB-8FTON45-S	7332-20975	1/2	3/4-16	.88	3.60	2.35
G47591-1010S	10ACB-10FTON45-S	7332-20985	1/2	7/8-14	.88	3.63	2.38
G47591-1210S	12ACB-10FTON45-S	7332-20995	5/8	7/8-14	.94	3.91	2.66
G47591-1212S	12ACB-12FTON45-S	7332-21005	5/8	1 1/16-14	.94	3.94	2.69

### Female SAE Tube O-Ring Nut Swivel - 90° Bent Tube - Aluminum

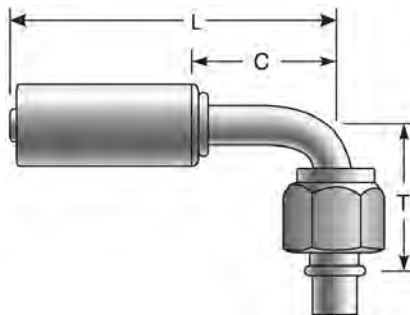

Part No.	Descr.	Prod. No.	⊖	🌀	T	L	C
			"	"	"	"	"
G47592-0606	6ACB-6FTON90	7332-51885	1/3	5/8-18	1.12	2.56	1.06
G47592-0608	6ACB-8FTON90	7332-51895	1/3	3/4-16	1.31	2.75	1.25
G47592-0806	8ACB-6FTON90	7332-52455	2/5	5/8-18	1.31	2.75	1.25
G47592-0808	8ACB-8FTON90	7332-51905	2/5	3/4-16	1.31	2.75	1.25
G47592-1008	10ACB-8FTON90	7332-52215	1/2	3/4-16	1.50	3.00	1.50
G47592-1010	10ACB-10FTON90	7332-51915	1/2	7/8-14	1.50	3.00	1.50
G47592-1012	10ACB-12FTON90	7332-52225	1/2	1 1/16-14	1.75	3.25	1.75
G47592-1210	12ACB-10FTON90	7332-51925	5/8	7/8-14	1.75	3.25	1.75
G47592-1212	12ACB-12FTON90	7332-51935	5/8	1 1/16-14	1.75	3.25	1.75

EQUIPMENT
HOSE/CPLG. SELECTION
G8K COUPLINGS
GLOBALSPIRAL COUPLINGS
STAINLESS STEEL SPIRAL
MEGACRIMP COUPLINGS
STAINLESS STEEL BRAID
POWER CRIMP COUPLINGS
FIELD ATTACHABLE G1 & G2 COUPLINGS
FIELD ATTACHABLE C5 COUPLINGS
C14 COUPLINGS
GL COUPLINGS
GLX COUPLINGS
PCTS THERMOPLASTIC COUPLINGS
POLARSEAL COUPLINGS (ACA)
POLARSEAL II COUPLINGS (ACC)
POLARSEAL II COUPLINGS (ACB)
POWER STEERING
ADAPTERS
QUICK DISCONNECT COUPLERS
BALL VALVES
LIVE SWIVEL
ASSEMBLY FABRICATION
ACCESSORIES
EQUIPMENT AND PARTS
KITS
AIR BRAKE HOSE ASSY
BRASS



EQUIPMENT
HOSE/CPLG. SELECTION
G8K COUPLINGS
GLOBAL SPIRAL COUPLINGS
STAINLESS STEEL SPIRAL
MEGACRIMP COUPLINGS
STAINLESS STEEL BRAID
POWER CRIMP COUPLINGS
FIELD ATTACHABLE G1 & G2 COUPLINGS
FIELD ATTACHABLE C5 COUPLINGS
C14 COUPLINGS
GL COUPLINGS
GLX COUPLINGS
PCTS THERMOPLASTIC COUPLINGS
POLARSEAL COUPLINGS (ACA)
POLARSEAL II COUPLINGS (ACC)
POLARSEAL II COUPLINGS (ACB)
POWER STEERING
ADAPTERS
QUICK DISCONNECT COUPLERS
BALL VALVES
LIVE SWIVEL
ASSEMBLY FABRICATION
ACCESSORIES
EQUIPMENT AND PARTS
KITS
AIR BRAKE HOSE ASSY
BRASS

## Female SAE Tube O-Ring Nut Swivel - 90° Bent Tube - Steel

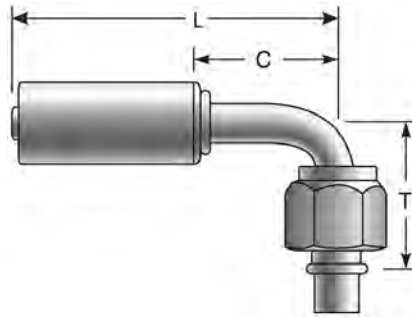

Part No.	Descr.	Prod. No.			T	L	C
			"	"			
G47592-0606S	6ACB-6FTON90-S	7332-21015	5/16	5/8-18	1.12	2.56	1.31
G47592-0608S	6ACB-8FTON90-S	7332-21025	5/16	3/4-16	1.31	2.75	1.50
G47592-0806S	8ACB-6FTON90-S	7332-21035	13/32	5/8-18	1.31	2.75	1.50
G47592-0808S	8ACB-8FTON90-S	7332-21045	13/32	3/4-16	1.31	2.75	1.50
G47592-1008S	10ACB-8FTON90-S	7332-21055	1/2	3/4-16	1.50	3.00	1.75
G47592-1010S	10ACB-10FTON90-S	7332-21065	1/2	7/8-14	1.50	3.00	1.75
G47592-1012S	10ACB-12FTON90-S	7332-21075	1/2	1 1/16-14	1.75	3.25	2.00
G47592-1210S	12ACB-10FTON90-S	7332-21085	5/8	7/8-14	1.75	3.25	2.00
G47592-1212S	12ACB-12FTON90-S	7332-21095	5/8	1 1/16-14	1.75	3.25	2.00

## Female SAE Tube O-Ring Metric Nut Swivel - Aluminum

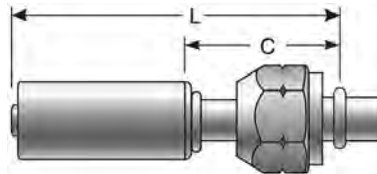

Part No.	Descr.	Prod. No.			L	C
			"	"		
G47593-0620	6ACB-20FTOMN	7332-52505	1/3	M18X1.5	2.94	1.44
G47593-0820	8ACB-20FTOMN	7332-52515	2/5	M18X1.5	2.94	1.44
G47593-1022	10ACB-22FTOMN	7332-51945	1/2	M18X1.5	3.19	1.69



### Female SAE Tube O-Ring Metric Nut Swivel - Steel

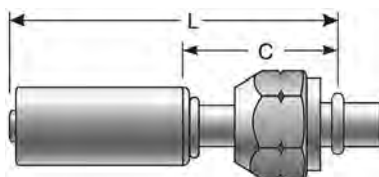

Part No.	Descr.	Prod. No.			L	C
			"	"		
G47593-0820S	8ACB-20FTOMN-S	7332-21105	13/32	M20X1.5	2.94	1.69
G47593-1227S	12ACB-27FTOMN-S	7332-21115	5/8	M27X2.0	3.31	2.06

### Female SAE Tube O-Ring Metric Nut Swivel - 45° Bent Tube - Aluminum

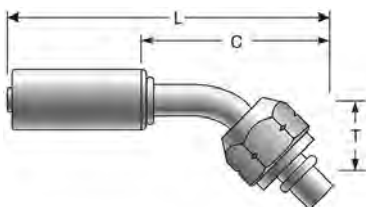

Part No.	Descr.	Prod. No.			T	L	C
			"	"			
G47594-0618	6ACB-18FTOMN45	7332-52525	1/3	M18X1.5	.69	3.56	2.06
G47594-0620	6ACB-20FTOMN45	7332-52535	1/3	M18X1.5	.75	3.07	1.57
G47594-0820	8ACB-20FTOMN45	7332-52545	2/5	M18X1.5	.75	3.75	2.25
G47594-1227	12ACB-27FTOMN45	7332-52555	5/8	M27X2.0	1.00	4.62	3.12

### Female SAE Tube O-Ring Metric Nut Swivel - 45° Bent Tube - Steel

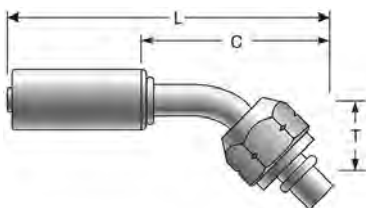

Part No.	Descr.	Prod. No.			T	L	C
			"	"			
G47594-0820S	8ACB-20FTOMN45-S	7332-21125	13/32	M20X1.5	.75	3.72	2.47
G47594-1227S	12ACB-27FTOMN45-S	7332-21135	5/8	M27X2.0	1.00	4.59	3.34

EQUIPMENT
HOSE/CPLG. SELECTION
G8K COUPLINGS
GLOBALSPIRAL COUPLINGS
STAINLESS STEEL SPIRAL
MEGACRIMP COUPLINGS
STAINLESS STEEL BRAID
POWER CRIMP COUPLINGS
FIELD ATTACHABLE G1 & G2 COUPLINGS
FIELD ATTACHABLE C5 COUPLINGS
C14 COUPLINGS
GL COUPLINGS
GLX COUPLINGS
PCTS THERMOPLASTIC COUPLINGS
POLARSEAL COUPLINGS (ACA)
POLARSEAL II COUPLINGS (ACC)
POLARSEAL II COUPLINGS (ACB)
POWER STEERING
ADAPTERS
QUICK DISCONNECT COUPLERS
BALL VALVES
LIVE SWIVEL
ASSEMBLY FABRICATION
ACCESSORIES
EQUIPMENT AND PARTS
KITS
AIR BRAKE HOSE ASSY
BRASS



EQUIPMENT
HOSE/CPLG. SELECTION
G8K COUPLINGS
GLOBAL SPIRAL COUPLINGS
STAINLESS STEEL SPIRAL
MEGACRIMP COUPLINGS
STAINLESS STEEL BRAID
POWER CRIMP COUPLINGS
FIELD ATTACHABLE G1 & G2 COUPLINGS
FIELD ATTACHABLE C5 COUPLINGS
C14 COUPLINGS
GL COUPLINGS
GLX COUPLINGS
PCTS THERMOPLASTIC COUPLINGS
POLARSEAL COUPLINGS (ACA)
POLARSEAL II COUPLINGS (ACC)
POLARSEAL II COUPLINGS (ACB)
POWER STEERING
ADAPTERS
QUICK DISCONNECT COUPLERS
BALL VALVES
LIVE SWIVEL
ASSEMBLY FABRICATION
ACCESSORIES
EQUIPMENT AND PARTS
KITS
AIR BRAKE HOSE ASSY
BRASS

## Female SAE Tube O-Ring Metric Nut Swivel - 90° Bent Tube - Aluminum

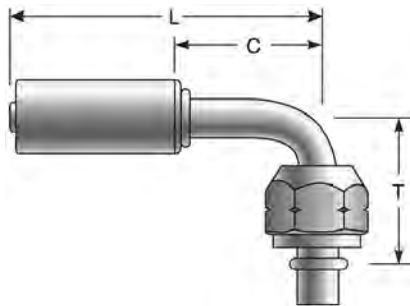

Part No.	Descr.	Prod. No.			T	L	C
			"	"	"	"	"
G47595-0618	6ACB-18FTOMN90	7332-52565	1/3	M18X1.5	1.12	2.75	1.25
G47595-0820	8ACB-20FTOMN90	7332-52575	2/5	M18X1.5	1.37	2.94	1.44
G47595-1227	12ACB-27FTOMN90	7332-51955	5/8	M27X2.0	1.75	3.38	1.88

## Female SAE Tube O-Ring Metric Nut Swivel - 90° Bent Tube - Steel

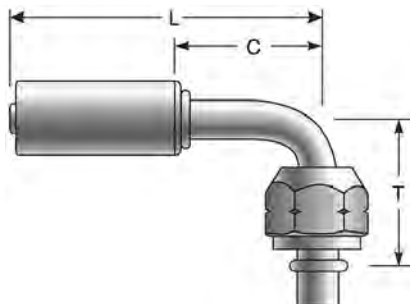

Part No.	Descr.	Prod. No.			T	L	C
			"	"	"	"	"
G47595-0820S	8ACB-20FTOMN90-S	7332-21145	13/32	M20X1.5	1.37	2.94	1.69
G47595-1227S	12ACB-27FTOMN90-S	7332-21155	5/8	M27X2.0	1.75	3.38	2.13



## Female SAE Tube O-Ring Nut Swivel - 90° Block - Steel

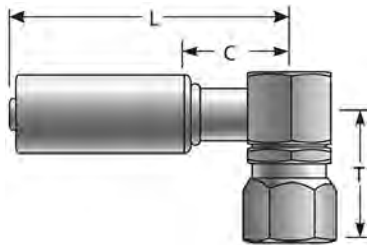

Part No.	Descr.	Prod. No.			T	L	C
			"	"			
G47596-0808S	8ACB-8FTON90BL-S	7332-21165	13/32	3/4-16	.71	2.44	1.19
G47596-1010S	10ACB-10FTON90BL-S	7332-21175	1/2	7/8-14	.71	2.50	1.25
G47596-1210S	12ACB-10FTON90BL-S	7332-21185	5/8	7/8-14	.71	2.62	1.37

## Male Inverted O-Ring - Aluminum

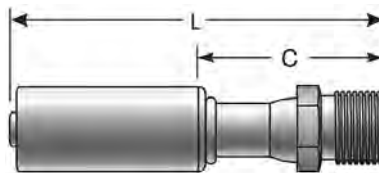

Part No.	Descr.	Prod. No.			L	C
			"	"		
G47597-0606	6ACB-6MIO	7332-51965	1/3	5/8-18	2.94	1.44
G47597-0808	8ACB-8MIO	7332-51975	2/5	3/4-16	3.13	1.63
G47597-1010	10ACB-10MIO	7332-51985	1/2	7/8-14	3.62	2.12
G47597-1212	12ACB-12MIO	7332-51995	5/8	1 1/16-14	3.88	2.38

## Male Inverted O-Ring - Steel

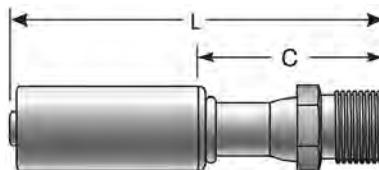

Part No.	Descr.	Prod. No.			L	C
			"	"		
G47597-0606S	6ACB-6MIO-S	7332-21195	5/16	5/8-18	2.94	1.69
G47597-0808S	8ACB-8MIO-S	7332-21205	13/32	3/4-18	3.13	1.88
G47597-1010S	10ACB-10MIO-S	7332-21215	1/2	7/8-14	3.62	2.37
G47597-1212S	12ACB-12MIO-S	7332-21225	5/8	1 1/16-14	3.88	2.63

EQUIPMENT
HOSE/CPLG. SELECTION
G8K COUPLINGS
GLOBALSPIRAL COUPLINGS
STAINLESS STEEL SPIRAL
MEGACRIMP COUPLINGS
STAINLESS STEEL BRAID
POWER CRIMP COUPLINGS
FIELD ATTACHABLE G1 & G2 COUPLINGS
FIELD ATTACHABLE C5 COUPLINGS
C14 COUPLINGS
GL COUPLINGS
GLX COUPLINGS
PCTS THERMOPLASTIC COUPLINGS
POLARSEAL COUPLINGS (ACA)
POLARSEAL II COUPLINGS (ACC)
POLARSEAL II COUPLINGS (ACB)
POWER STEERING
ADAPTERS
QUICK DISCONNECT COUPLERS
BALL VALVES
LIVE SWIVEL
ASSEMBLY FABRICATION
ACCESSORIES
EQUIPMENT AND PARTS
KITS
AIR BRAKE HOSE ASSY
BRASS



EQUIPMENT
HOSE/CPLG. SELECTION
G8K COUPLINGS
GLOBAL SPIRAL COUPLINGS
STAINLESS STEEL SPIRAL
MEGACRIMP COUPLINGS
STAINLESS STEEL BRAID
POWER CRIMP COUPLINGS
FIELD ATTACHABLE G1 & G2 COUPLINGS
FIELD ATTACHABLE C5 COUPLINGS
C14 COUPLINGS
GL COUPLINGS
GLX COUPLINGS
PCTS THERMOPLASTIC COUPLINGS
POLARSEAL COUPLINGS (ACA)
POLARSEAL II COUPLINGS (ACC)
<b>POLARSEAL II COUPLINGS (ACB)</b>
POWER STEERING
ADAPTERS
QUICK DISCONNECT COUPLERS
BALL VALVES
LIVE SWIVEL
ASSEMBLY FABRICATION
ACCESSORIES
EQUIPMENT AND PARTS
KITS
AIR BRAKE HOSE ASSY
BRASS

### Male Inverted O-Ring - 45° Bent Tube - Aluminum

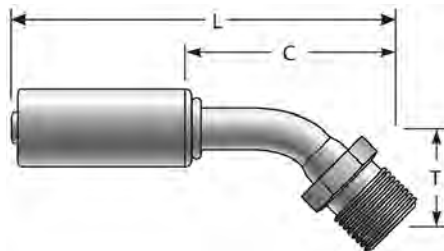

Part No.	Descr.	Prod. No.	⊖		T	L	C
			"	"	"	"	"
G47598-0606	6ACB-6MIO45	7332-52585	1/3	5/8-18	.75	3.06	1.56
G47598-0808	8ACB-8MIO45	7332-52595	2/5	3/4-16	1.00	3.44	1.94
G47598-1010	10ACB-10MIO45	7332-52605	1/2	7/8-14	1.25	4.00	2.50

### Male Inverted O-Ring - 45° Bent Tube - Steel

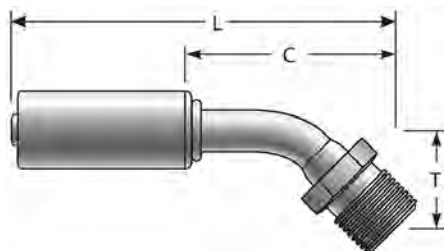

Part No.	Descr.	Prod. No.	⊖		T	L	C
			"	"	"	"	"
G47598-1010S	10ACB-10MIO45-S	7332-21235	1/2	7/8-14	1.25	3.97	2.72

### Male Inverted O-Ring - 90° Bent Tube - Aluminum

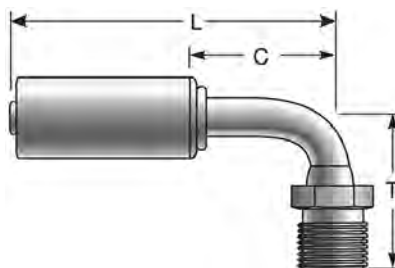

Part No.	Descr.	Prod. No.	⊖		T	L	C
			"	"	"	"	"
G47599-0606	6ACB-6MIO90	7332-52005	1/3	5/8-18	1.50	2.56	1.06
G47599-0808	8ACB-8MIO90	7332-52015	2/5	3/4-16	1.75	2.75	1.25
G47599-1010	10ACB-10MIO90	7332-52025	1/2	7/8-16	2.00	3.00	1.50



### Male Inverted O-Ring - 90° Bent Tube - Steel

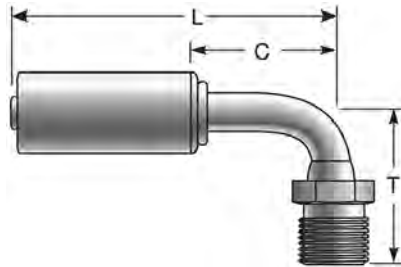

Part No.	Descr.	Prod. No.	⊖	🌀	T	L	C
			"	"	"	"	"
G47599-0606S	6ACB-6MIO90-S	7332-21245	5/16	5/8-18	1.50	2.56	1.31
G47599-0808S	8ACB-8MIO90-S	7332-21255	13/32	3/4-18	1.75	2.75	1.50
G47599-1010S	10ACB-10MIO90-S	7332-21265	1/2	7/8-14	2.00	3.00	1.75

### Male Inverted O-Ring Bulkhead - Steel

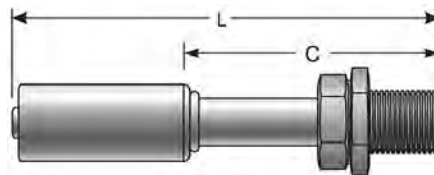

Part No.	Descr.	Prod. No.	⊖	🌀	L	C
			"	"	"	"
G47600-0606S	6ACB-6MIOBKHD-S	7332-21275	5/16	5/8-18	4.00	2.75
G47600-0808S	8ACB-8MIOBKHD-S	7332-21285	13/32	3/4-18	4.25	3.00
G47600-1010S	10ACB-10MIOBKHD-S	7332-21295	1/2	7/8-14	4.44	3.19

### Male Inverted O-Ring Bulkhead - 90° Bent Tube - Steel

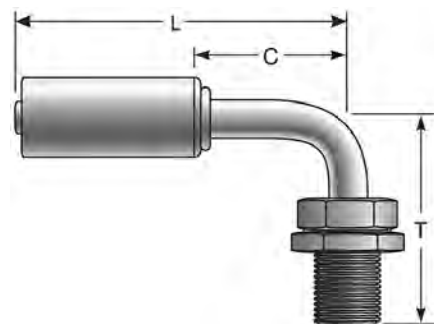

Part No.	Descr.	Prod. No.	⊖	🌀	T	L	C
			"	"	"	"	"
G47602-0606S	6ACB-6MIOBKHD90-S	7332-21305	5/16	5/8-18	2.12	3.13	1.88

EQUIPMENT
HOSE/CPLG. SELECTION
G8K COUPLINGS
GLOBALSPIRAL COUPLINGS
STAINLESS STEEL SPIRAL
MEGACRIMP COUPLINGS
STAINLESS STEEL BRAID
POWER CRIMP COUPLINGS
FIELD ATTACHABLE G1 & G2 COUPLINGS
FIELD ATTACHABLE C5 COUPLINGS
C14 COUPLINGS
GL COUPLINGS
GLX COUPLINGS
PCTS THERMOPLASTIC COUPLINGS
POLARSEAL COUPLINGS (ACA)
POLARSEAL II COUPLINGS (ACC)
<b>POLARSEAL II COUPLINGS (ACB)</b>
POWER STEERING
ADAPTERS
QUICK DISCONNECT COUPLERS
BALL VALVES
LIVE SWIVEL
ASSEMBLY FABRICATION
ACCESSORIES
EQUIPMENT AND PARTS
KITS
AIR BRAKE HOSE ASSY
BRASS





EQUIPMENT
HOSE/CPLG. SELECTION
G8K COUPLINGS
GLOBAL SPIRAL COUPLINGS
STAINLESS STEEL SPIRAL
MEGACRIMP COUPLINGS
STAINLESS STEEL BRAID
POWER CRIMP COUPLINGS
FIELD ATTACHABLE G1 & G2 COUPLINGS
FIELD ATTACHABLE C5 COUPLINGS
C14 COUPLINGS
GL COUPLINGS
GLX COUPLINGS
PCTS THERMOPLASTIC COUPLINGS
POLARSEAL COUPLINGS (ACA)
POLARSEAL II COUPLINGS (ACC)
<b>POLARSEAL II COUPLINGS (ACB)</b>
POWER STEERING
ADAPTERS
QUICK DISCONNECT COUPLERS
BALL VALVES
LIVE SWIVEL
ASSEMBLY FABRICATION
ACCESSORIES
EQUIPMENT AND PARTS
KITS
AIR BRAKE HOSE ASSY
BRASS

### Male Inverted O-Ring Bulkhead - 90° Bent Tube - Steel - Continued

Part No.	Descr.	Prod. No.			T	L	C
			"	"			
G47602-0808S	8ACB-8MIOBKHD90-S	7332-21315	13/32	3/4-18	2.44	3.25	2.00
G47602-1010S	10ACB-10MIOBKHD90-S	7332-21325	1/2	7/8-14	2.50	3.50	2.25

### Female SAE Tube O-Ring Nut - 180° Bent Tube - Aluminum

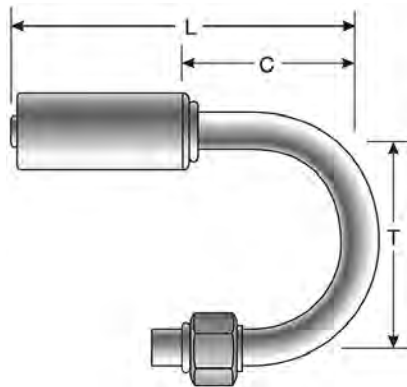

Part No.	Descr.	Prod. No.			T	L	C
			"	"			
G47610-0606	6ACB-6FTON180	7332-52615	1/3	5/8-18	1.65	1.00	2.15
G47610-0808	8ACB-8FTON180	7332-52625	2/5	3/4-16	1.75	1.00	2.25
G47610-1212	12ACB-12FTON180	7332-52635	5/8	1 1/16-14	2.12	1.50	2.94

### Female SAE Tube O-Ring Nut - 180° Bent Tube - Steel

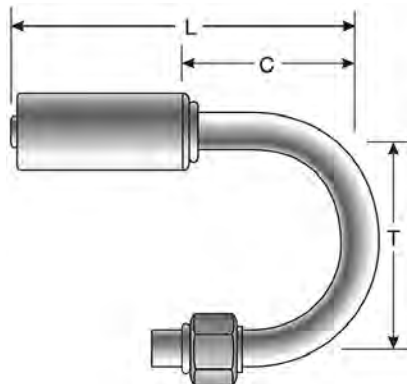

Part No.	Descr.	Prod. No.			T	L	C
			"	"			
G47610-0606S	6ACB-6FTON180-S	7332-21335	5/16	5/8-18	1.63	3.50	2.25
G47610-1010S	10ACB-10FTON180-S	7332-52755	5/8	7/8-14	3.00	4.00	2.50



### Universal Tee O-Ring Splicer English Threads - Aluminum

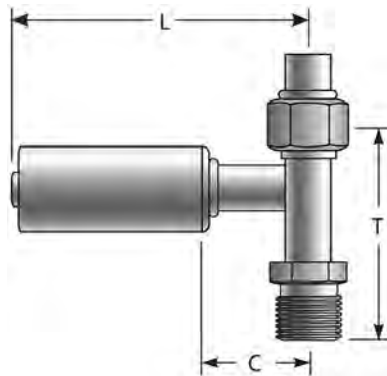

Part No.	Descr.	Prod. No.	⊖		T	L	C
			"	"	"	"	"
G47614-1010	10ACB-10TORSP	7332-52645	1/2	7/8-14	3.33	2.75	1.25

### Male (Ford) Spring Lock - 45° Bent Tube - Aluminum

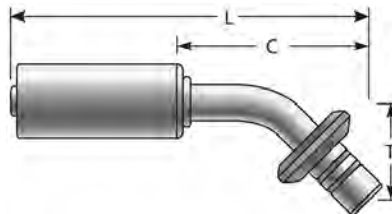

Part No.	Descr.	Prod. No.	⊖	T	L	C
			"	"	"	"
G47949-0606	6ACB-6MSL45	7332-52655	1/3	1.25	4.00	2.50
G47949-0808	8ACB-8MSL45	7332-52665	2/5	1.31	4.12	2.62
G47949-1010	10ACB-10MSL45	7332-52675	1/2	1.63	4.51	3.01
G47949-1212	12ACB-12MSL45	7332-52685	5/8	1.75	4.75	3.25

### Male (Ford) Spring Lock - Aluminum

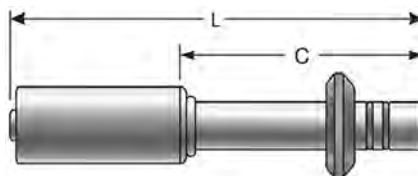

Part No.	Descr.	Prod. No.	⊖	L	C
			"	"	"
G47950-0606	6ACB-6MSL	7332-52035	1/3	3.81	2.31
G47950-0808	8ACB-8MSL	7332-52045	2/5	3.88	2.38

EQUIPMENT
HOSE/CPLG. SELECTION
G8K COUPLINGS
GLOBALSPIRAL COUPLINGS
STAINLESS STEEL SPIRAL
MEGACRIMP COUPLINGS
STAINLESS STEEL BRAID
POWER CRIMP COUPLINGS
FIELD ATTACHABLE G1 & G2 COUPLINGS
FIELD ATTACHABLE C5 COUPLINGS
C14 COUPLINGS
GL COUPLINGS
GLX COUPLINGS
PCTS THERMOPLASTIC COUPLINGS
POLARSEAL COUPLINGS (ACA)
POLARSEAL II COUPLINGS (ACC)
<b>POLARSEAL II COUPLINGS (ACB)</b>
POWER STEERING
ADAPTERS
QUICK DISCONNECT COUPLERS
BALL VALVES
LIVE SWIVEL
ASSEMBLY FABRICATION
ACCESSORIES
EQUIPMENT AND PARTS
KITS
AIR BRAKE HOSE ASSY
BRASS



EQUIPMENT
HOSE/CPLG. SELECTION
G8K COUPLINGS
GLOBAL SPIRAL COUPLINGS
STAINLESS STEEL SPIRAL
MEGACRIMP COUPLINGS
STAINLESS STEEL BRAID
POWER CRIMP COUPLINGS
FIELD ATTACHABLE G1 & G2 COUPLINGS
FIELD ATTACHABLE C5 COUPLINGS
C14 COUPLINGS
GL COUPLINGS
GLX COUPLINGS
PCTS THERMOPLASTIC COUPLINGS
POLARSEAL COUPLINGS (ACA)
POLARSEAL II COUPLINGS (ACC)
<b>POLARSEAL II COUPLINGS (ACB)</b>
POWER STEERING
ADAPTERS
QUICK DISCONNECT COUPLERS
BALL VALVES
LIVE SWIVEL
ASSEMBLY FABRICATION
ACCESSORIES
EQUIPMENT AND PARTS
KITS
AIR BRAKE HOSE ASSY
BRASS

### Male (Ford) Spring Lock - Aluminum - Continued

Part No.	Descr.	Prod. No.	⊖	L	C
			"	"	"
G47950-1010	10ACB-10MSL	7332-52055	1/2	4.00	2.50

### Male (Ford) Spring Lock - 90° Bent Tube - Aluminum

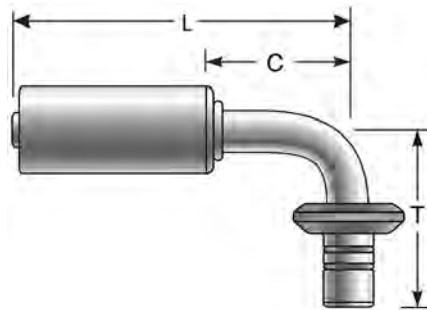

Part No.	Descr.	Prod. No.	⊖	T	L	C
			"	"	"	"
G47951-0608	6ACB-8MSL90	7332-52275	1/3	2.38	3.31	1.81
G47951-0808	8ACB-8MSL90	7332-52255	2/5	2.38	2.94	1.44
G47951-1010	10ACB-10MSL90	7332-52265	1/2	2.50	3.13	1.63

### Female (Ford) Spring Lock - 90° Bent Tube - Aluminum

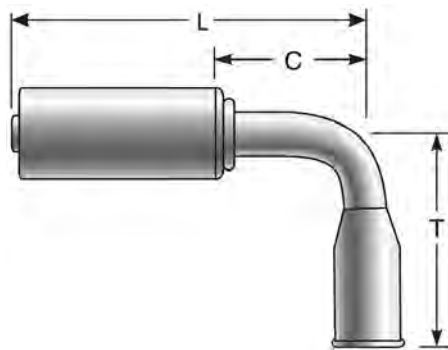

Part No.	Descr.	Prod. No.	⊖	T	L	C
			"	"	"	"
G47953-0606	6ACB-6FSL90	7332-52285	1/3	2.19	2.88	1.38
G47953-1010	10ACB-10FSL90	7332-52295	1/2	2.50	3.13	1.63



### Hose Splicer with R12 Thread Service Port - Aluminum

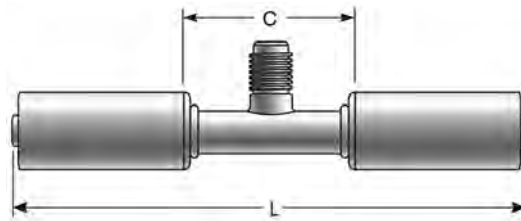

Part No.	Descr.	Prod. No.	⊖	L	C
			"		
G47954-0606	6ACB-R12SP	7332-52065	1/3	4.50	1.50
G47954-1010	10ACB-R12SP	7332-52075	1/2	4.63	1.63
G47954-1212	12ACB-R12SP	7332-52085	5/8	4.75	1.75

### Hose Splicer with R12 Thread Service Port - Steel

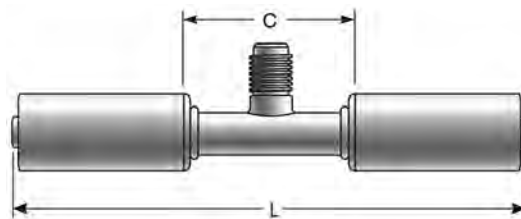

Part No.	Descr.	Prod. No.	⊖	L	C
			"		
G47954-0606S	6ACB-R12SP-S	7332-21345	5/16	4.50	2.00
G47954-0808S	8ACB-R12SP-S	7332-21355	13/32	4.50	2.00
G47954-1010S	10ACB-R12SP-S	7332-21365	1/2	4.63	2.13

### Hose Splicer with R134a Service Port - Aluminum

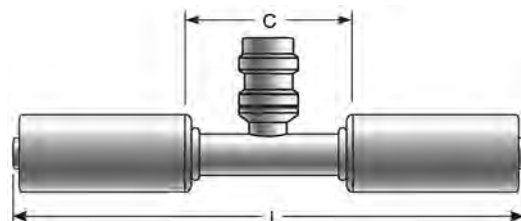

Part No.	Descr.	Prod. No.	⊖	L	C
			"		
G47956-0606	6ACB-R134SP	7332-52095	1/3	4.50	1.50
G47956-0808	8ACB-R134SP	7332-52105	2/5	4.50	1.50
G47956-1010	10ACB-R134SP	7332-52115	1/2	4.63	1.63
G47956-1212	12ACB-R134SP	7332-52125	5/8	4.75	1.75

EQUIPMENT
HOSE/CPLG. SELECTION
G8K COUPLINGS
GLOBALSPIRAL COUPLINGS
STAINLESS STEEL SPIRAL
MEGACRIMP COUPLINGS
STAINLESS STEEL BRAID
POWER CRIMP COUPLINGS
FIELD ATTACHABLE G1 & G2 COUPLINGS
FIELD ATTACHABLE C5 COUPLINGS
C14 COUPLINGS
GL COUPLINGS
GLX COUPLINGS
PCTS THERMOPLASTIC COUPLINGS
POLARSEAL COUPLINGS (ACA)
POLARSEAL II COUPLINGS (ACC)
<b>POLARSEAL II COUPLINGS (ACB)</b>
POWER STEERING
ADAPTERS
QUICK DISCONNECT COUPLERS
BALL VALVES
LIVE SWIVEL
ASSEMBLY FABRICATION
ACCESSORIES
EQUIPMENT AND PARTS
KITS
AIR BRAKE HOSE ASSY
BRASS



EQUIPMENT
HOSE/CPLG. SELECTION
G8K COUPLINGS
GLOBAL SPIRAL COUPLINGS
STAINLESS STEEL SPIRAL
MEGACRIMP COUPLINGS
STAINLESS STEEL BRAID
POWER CRIMP COUPLINGS
FIELD ATTACHABLE G1 & G2 COUPLINGS
FIELD ATTACHABLE C5 COUPLINGS
C14 COUPLINGS
GL COUPLINGS
GLX COUPLINGS
PCTS THERMOPLASTIC COUPLINGS
POLARSEAL COUPLINGS (ACA)
POLARSEAL II COUPLINGS (ACC)
POLARSEAL II COUPLINGS (ACB)
POWER STEERING
ADAPTERS
QUICK DISCONNECT COUPLERS
BALL VALVES
LIVE SWIVEL
ASSEMBLY FABRICATION
ACCESSORIES
EQUIPMENT AND PARTS
KITS
AIR BRAKE HOSE ASSY
BRASS

## Hose Splicer with R134a Service Port - Steel

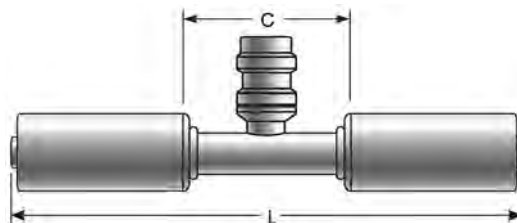

Part No.	Descr.	Prod. No.		L	C
			"	"	"
G47956-0606S	6ACB-R134SP-S	7332-21375	5/16	4.50	2.00
G47956-0808S	8ACB-R134SP-S	7332-21385	13/32	4.50	2.00
G47956-1010S	10ACB-R134SP-S	7332-21395	1/2	4.63	2.13
G47956-1212S	12ACB-R134SP-S	7332-21405	5/8	4.75	2.25

## Compressor Female SAE Tube O-Ring Nut Swivel - 90° Bent Tube - Steel

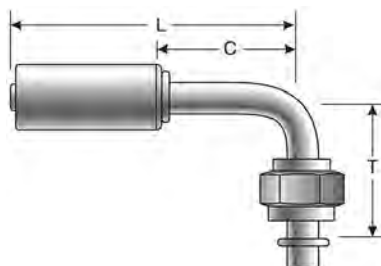

Part No.	Descr.	Prod. No.			T	L	C
			"	"	"	"	"
G47958-0606S	6ACB-6CFTON90-S	7332-21415	5/16	1-14	.84	.94	2.44
G47958-1010S	10ACB-10CFTON90-S	7332-21425	1/2	1-14	.84	.94	2.63



## Compressor Female Tube O-Ring Nut with 134a Service Port - 90° Block - Steel

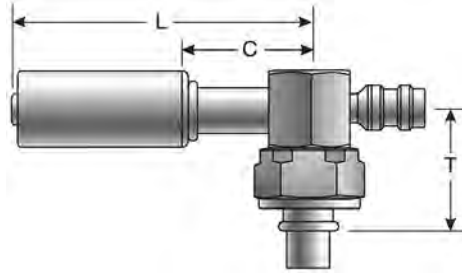

Part No.	Descr.	Prod. No.	⊖	🌀	T	L	C
			"	"	"	"	"
G47960-0810S	8ACB-10CFTON134SP90BL-S	7332-21435	13/32	1-14	.78	2.45	1.20
G47960-1010S	10ACB-10CFTON134SP90BL-S	7332-21445	1/2	1-14	.78	2.51	1.26
G47960-1210S	12ACB-10CFTON134SP90BL-S	7332-21455	5/8	1-14	.78	2.67	1.42

EQUIPMENT
HOSE/CPLG. SELECTION
G8K COUPLINGS
GLOBALSPIRAL COUPLINGS
STAINLESS STEEL SPIRAL
MEGACRIMP COUPLINGS
STAINLESS STEEL BRAID
POWER CRIMP COUPLINGS
FIELD ATTACHABLE G1 & G2 COUPLINGS
FIELD ATTACHABLE C5 COUPLINGS
C14 COUPLINGS
GL COUPLINGS
GLX COUPLINGS
PCTS THERMOPLASTIC COUPLINGS
POLARSEAL COUPLINGS (ACA)
POLARSEAL II COUPLINGS (ACC)
<b>POLARSEAL II COUPLINGS (ACB)</b>
POWER STEERING
ADAPTERS
QUICK DISCONNECT COUPLERS
BALL VALVES
LIVE SWIVEL
ASSEMBLY FABRICATION
ACCESSORIES
EQUIPMENT AND PARTS
KITS
AIR BRAKE HOSE ASSY
BRASS



**NOTES**

EQUIPMENT
HOSE/CPLG. SELECTION
G8K COUPLINGS
GLOBAL SPIRAL COUPLINGS
STAINLESS STEEL SPIRAL
MEGACRIMP COUPLINGS
STAINLESS STEEL BRAID
POWER CRIMP COUPLINGS
FIELD ATTACHABLE G1 & G2 COUPLINGS
FIELD ATTACHABLE C5 COUPLINGS
C14 COUPLINGS
GL COUPLINGS
GLX COUPLINGS
PCTS THERMOPLASTIC COUPLINGS
POLARSEAL COUPLINGS (ACA)
POLARSEAL II COUPLINGS (ACC)
POLARSEAL II COUPLINGS (ACB)
POWER STEERING
ADAPTERS
QUICK DISCONNECT COUPLERS
BALL VALVES
LIVE SWIVEL
ASSEMBLY FABRICATION
ACCESSORIES
EQUIPMENT AND PARTS
KITS
AIR BRAKE HOSE ASSY
BRASS





### SAE Male Flareless (includes Sleeve and Nut)

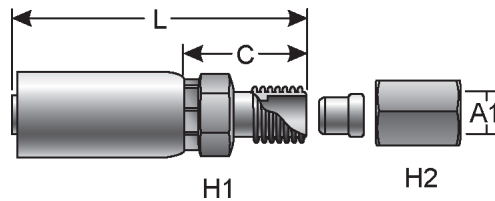

Part No.	Descr.	Prod. No.	⊖		🌀	H1	H2	L		C		A1
			"	mm				"	"	"	mm	
G50510-0604	6PS-4MFA	7334-28615	3/8	9.7	7/16-20	11/16	9/16	2.37	60.2	1.00	25.4	1/4
G50510-0605	6PS-5MFA	7334-28625	3/8	9.7	1/2-20	11/16	5/8	2.37	60.2	1.00	25.4	5/16
G50510-0606	6PS-6MFA	7334-28635	3/8	9.7	5/8-18	11/16	11/16	2.39	60.7	1.01	25.7	3/8

### SAE Metric Male Flareless (includes Sleeve and Nut)

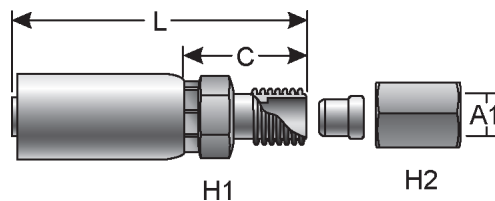

Part No.	Descr.	Prod. No.	⊖		🌀	H1	H2	L		C		A1
			"	mm				"	"	"	mm	
G50510-0608	6PSM-8MFA	7334-28935	3/8	9.7	3/4-16	11/16	11/16	2.31	58.7	.93	23.6	8.0
G50510-0610	6PSM-10MFA	7334-28945	3/8	9.7	7/8-14	11/16	3/4	2.35	59.7	.97	24.6	10.0
G50510-0612	6PSM-12MFA	7334-28955	3/8	9.7	1 1/16-12	3/4	7/8	2.35	59.7	.97	24.6	12.0

EQUIPMENT
HOSE/CPLG. SELECTION
G8K COUPLINGS
GLOBALSPIRAL COUPLINGS
STAINLESS STEEL SPIRAL
MEGACRIMP COUPLINGS
STAINLESS STEEL BRAID
POWER CRIMP COUPLINGS
FIELD ATTACHABLE G1 & G2 COUPLINGS
FIELD ATTACHABLE C5 COUPLINGS
C14 COUPLINGS
GL COUPLINGS
GLX COUPLINGS
PCTS THERMOPLASTIC COUPLINGS
POLARSEAL COUPLINGS (ACA)
POLARSEAL II COUPLINGS (ACC)
POLARSEAL II COUPLINGS (ACB)
POWER STEERING
ADAPTERS
QUICK DISCONNECT COUPLERS
BALL VALVES
LIVE SWIVEL
ASSEMBLY FABRICATION
ACCESSORIES
EQUIPMENT AND PARTS
KITS
AIR BRAKE HOSE ASSY
BRASS



**NOTES**

EQUIPMENT
HOSE/CPLG. SELECTION
G8K COUPLINGS
GLOBAL SPIRAL COUPLINGS
STAINLESS STEEL SPIRAL
MEGACRIMP COUPLINGS
STAINLESS STEEL BRAID
POWER CRIMP COUPLINGS
FIELD ATTACHABLE G1 & G2 COUPLINGS
FIELD ATTACHABLE C5 COUPLINGS
C14 COUPLINGS
GL COUPLINGS
GLX COUPLINGS
PCTS THERMOPLASTIC COUPLINGS
POLARSEAL COUPLINGS (ACA)
POLARSEAL II COUPLINGS (ACC)
POLARSEAL II COUPLINGS (ACB)
<b>POWER STEERING</b>
ADAPTERS
QUICK DISCONNECT COUPLERS
BALL VALVES
LIVE SWIVEL
ASSEMBLY FABRICATION
ACCESSORIES
EQUIPMENT AND PARTS
KITS
AIR BRAKE HOSE ASSY
BRASS



### Male Pipe NPTF Plug

For use up to SAE 100R2 maximum working pressure.

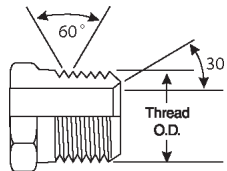
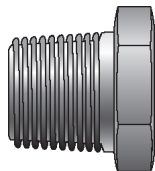

Part No.	Descr.	Prod. No.		
			"	"
G60102-0002	2MP-PLUG	7259-22815	1/8-27	
G60102-0004	4MP-PLUG	7259-22825	1/4-18	
G60102-0006	6MP-PLUG	7259-22835	3/8-18	
G60102-0008	8MP-PLUG	7259-22845	1/2-14	
G60102-0012	12MP-PLUG	7259-22855	3/4-14	
G60102-0016	16MP-PLUG	7259-22865	1-11 1/2	
G60102-0020	20MP-PLUG	7259-22875	1 1/4-11 1/2	
G60102-0024	24MP-PLUG	7259-24395	1 1/2-11 1/2	
G60102-0032	32MP-PLUG	7259-32765	2-11 1/2	

### Male Pipe NPTF to Male Pipe NPTF

For use up to SAE 100R2 maximum working pressure.

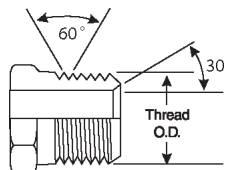
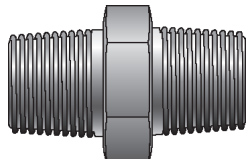

Part No.	Descr.	Prod. No.		
			"	"
G60110-0202	2MP-2MP	7259-23695	1/8-27	1/8-27
G60110-0402	4MP-2MP	7259-23705	1/4-18	1/8-27
G60110-0404	4MP-4MP	7259-23715	1/4-18	1/4-18
G60110-0602	6MP-2MP	7259-06455	3/8-18	1/8-27
G60110-0604	6MP-4MP	7259-23725	3/8-18	1/4-18
G60110-0606	6MP-6MP	7259-23735	3/8-18	3/8-18
G60110-0804	8MP-4MP	7259-23745	1/2-14	1/4-18
G60110-0806	8MP-6MP	7259-23755	1/2-14	3/8-18
G60110-0808	8MP-8MP	7259-23765	1/2-14	1/2-14
G60110-1204	12MP-4MP	7259-07405	3/4-14	1/4-18
G60110-1206	12MP-6MP	7259-06395	3/4-14	3/8-18
G60110-1208	12MP-8MP	7259-23775	3/4-14	1/2-14
G60110-1212	12MP-12MP	7259-23785	3/4-14	3/4-14
G60110-1606	16MP-6MP	7259-07325	1-11 1/2	3/8-18
G60110-1608	16MP-8MP	7259-06235	1-11 1/2	1/2-14
G60110-1612	16MP-12MP	7259-23795	1-11 1/2	3/4-14
G60110-1616	16MP-16MP	7259-23805	1-11 1/2	1-11 1/2
G60110-2012	20MP-12MP	7259-08015	1 1/4-11 1/2	3/4-14
G60110-2016	20MP-16MP	7259-05875	1 1/4-11 1/2	1-11 1/2
G60110-2020	20MP-20MP	7259-23815	1 1/4-11 1/2	1 1/4-11 1/2
G60110-2412	24MP-12MP	7259-08545	1 1/2-11 1/2	3/4-14
G60110-2416	24MP-16MP	7259-08025	1 1/2-11 1/2	1-11 1/2

- EQUIPMENT
- HOSE/CPLG. SELECTION
- G8K COUPLINGS
- GLOBALSPIRAL COUPLINGS
- STAINLESS STEEL SPIRAL
- MEGACRIMP COUPLINGS
- STAINLESS STEEL BRAID
- POWER CRIMP COUPLINGS
- FIELD ATTACHABLE G1 & G2 COUPLINGS
- FIELD ATTACHABLE C5 COUPLINGS
- C14 COUPLINGS
- GL COUPLINGS
- GLX COUPLINGS
- PCTS THERMOPLASTIC COUPLINGS
- POLARSEAL COUPLINGS (ACA)
- POLARSEAL II COUPLINGS (ACC)
- POLARSEAL II COUPLINGS (ACB)
- POWER STEERING
- ADAPTERS**
- QUICK DISCONNECT COUPLERS
- BALL VALVES
- LIVE SWIVEL
- ASSEMBLY FABRICATION
- ACCESSORIES
- EQUIPMENT AND PARTS
- KITS
- AIR BRAKE HOSE ASSY
- BRASS



EQUIPMENT
HOSE/CPLG. SELECTION
G8K COUPLINGS
GLOBAL SPIRAL COUPLINGS
STAINLESS STEEL SPIRAL
MEGACRIMP COUPLINGS
STAINLESS STEEL BRAID
POWER CRIMP COUPLINGS
FIELD ATTACHABLE G1 & G2 COUPLINGS
FIELD ATTACHABLE C5 COUPLINGS
C14 COUPLINGS
GL COUPLINGS
GLX COUPLINGS
PCTS THERMOPLASTIC COUPLINGS
POLARSEAL COUPLINGS (ACA)
POLARSEAL II COUPLINGS (ACC)
POLARSEAL II COUPLINGS (ACB)
POWER STEERING
ADAPTERS
QUICK DISCONNECT COUPLERS
BALL VALVES
LIVE SWIVEL
ASSEMBLY FABRICATION
ACCESSORIES
EQUIPMENT AND PARTS
KITS
AIR BRAKE HOSE ASSY
BRASS

### Male Pipe NPTF to Male Pipe NPTF - Continued

Part No.	Descr.	Prod. No.		
			"	"
G60110-2420	24MP-20MP	7259-08125	1 1/2-11 1/2	1 1/4-11 1/2
G60110-2424	24MP-24MP	7259-23825	1 1/2-11 1/2	1 1/2-11 1/2
G60110-3224	32MP-24MP	7259-08555	2-11 1/2	1 1/2-11 1/2
G60110-3232	32MP-32MP	7259-23835	2-11 1/2	2-11 1/2

### Male Pipe NPTF to Male Pipe NPTF - 90°

For use up to SAE 100R2 maximum working pressure.

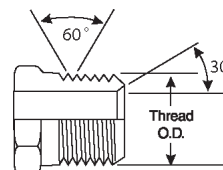
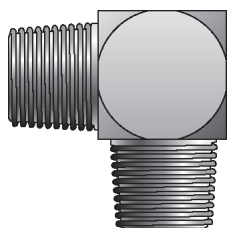

Part No.	Descr.	Prod. No.		
			"	"
G60115-0202	2MP-2MP90	7259-25205	1/8-27	1/8-27
G60115-0404	4MP-4MP90	7259-25215	1/4-18	1/4-18
G60115-0604	6MP-4MP90	7259-70755	3/8-18	1/4-18
G60115-0606	6MP-6MP90	7259-25225	3/8-18	3/8-18
G60115-0804	8MP-4MP90	7259-08565	1/2-14	1/4-18
G60115-0806	8MP-6MP90	7259-70855	1/2-14	3/8-18
G60115-0808	8MP-8MP90	7259-25235	1/2-14	1/2-14
G60115-1208	12MP-8MP90	7259-05725	3/4-14	1/2-14
G60115-1212	12MP-12MP90	7259-25245	3/4-14	3/4-14
G60115-1612	16MP-12MP90	7259-09835	1-11 1/2	3/4-14
G60115-1616	16MP-16MP90	7259-25255	1-11 1/2	1-11 1/2
G60115-2020	20MP-20MP90	7259-08575	1 1/4-11 1/2	1 1/4-11 1/2
G60115-2424	24MP-24MP90	7259-07155	1 1/2-11 1/2	1 1/2-11 1/2

### Male Pipe NPTF to Female Pipe NPTF Reducer Bushing - Short

For use up to SAE 100R2 maximum working pressure.

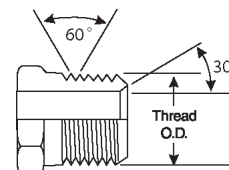
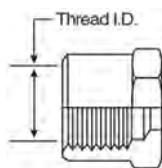
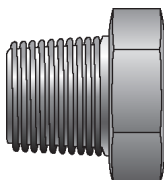

Part No.	Descr.	Prod. No.		
			"	"
G60130-0402	4MP-2FPS	7259-22595	1/4-18	1/8-27
G60130-0602	6MP-2FPS	7259-22605	3/8-18	1/8-27
G60130-0604	6MP-4FPS	7259-22615	3/8-18	1/4-18
G60130-0802	8MP-2FPS	7259-05815	1/2-14	1/8-27





Male Pipe NPTF to Female Pipe NPTF Reducer Bushing - Short - Continued

Part No.	Descr.	Prod. No.		
			"	"
G60130-0804	8MP-4FPS	7259-22635	1/2-14	1/4-18
G60130-0806	8MP-6FPS	7259-22645	1/2-14	3/8-18
G60130-1202	12MP-2FPS	7259-07335	3/4-14	1/8-27
G60130-1204	12MP-4FPS	7259-22665	3/4-14	1/4-18
G60130-1206	12MP-6FPS	7259-22675	3/4-14	3/8-18
G60130-1208	12MP-8FPS	7259-22685	3/4-14	1/2-14
G60130-1602	16MP-2FPS	7259-08585	1-11 1/2	1/8-27
G60130-1604	16MP-4FPS	7259-05355	1-11 1/2	1/4-18
G60130-1606	16MP-6FPS	7259-06665	1-11 1/2	3/8-18
G60130-1608	16MP-8FPS	7259-22725	1-11 1/2	1/2-14
G60130-1612	16MP-12FPS	7259-22735	1-11 1/2	3/4-14
G60130-2004	20MP-4FPS	7259-07475	1 1/4-11 1/2	1/4-18
G60130-2008	20MP-8FPS	7259-05525	1 1/4-11 1/2	1/2-14
G60130-2012	20MP-12FPS	7259-22755	1 1/4-11 1/2	3/4-14
G60130-2016	20MP-16FPS	7259-22765	1 1/4-11 1/2	1-11 1/2
G60130-2412	24MP-12FPS	7259-22785	1 1/2-11 1/2	3/4-14
G60130-2416	24MP-16FPS	7259-22795	1 1/2-11 1/2	1-11 1/2
G60130-2420	24MP-20FPS	7259-22805	1 1/2-11 1/2	1 1/4-11 1/2
G60130-3220	32MP-20FPS	7259-05425	2-11 1/2	1 1/4-11 1/2
G60130-3224	32MP-24FPS	7259-32825	2-11 1/2	1 1/2-11 1/2

Male Pipe NPTF to Female Pipe NPTF Increasing Bushing - Long

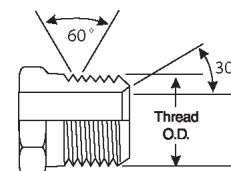
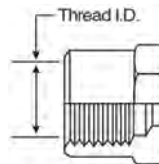
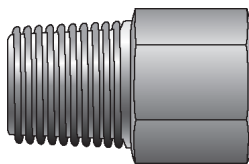
For use up to SAE 100R2 maximum working pressure.



Part No.	Descr.	Prod. No.		
			"	"
G60132-0204	2MP-4FPL	7259-25365	1/8-27	1/4-18
G60132-0206	2MP-6FPL	7259-08365	1/8-27	3/8-18
G60132-0402	4MP-2FPL	7259-08615	1/4-18	1/8-27
G60132-0404	4MP-4FPL	7259-00475	1/4-18	1/4-18
G60132-0406	4MP-6FPL	7259-25385	1/4-18	3/8-18
G60132-0408	4MP-8FPL	7259-05515	1/4-18	1/2-14
G60132-0604	6MP-4FPL	7259-05025	3/8-18	1/4-18
G60132-0606	6MP-6FPL	7259-00535	3/8-18	3/8-18
G60132-0608	6MP-8FPL	7259-25415	3/8-18	1/2-14
G60132-0808	8MP-8FPL	7259-05175	1/2-14	1/2-14
G60132-0812	8MP-12FPL	7259-25435	1/2-14	3/4-14
G60132-0816	8MP-16FPL	7259-07755	1/2-14	1-11 1/2
G60132-1208	12MP-8FPL	7259-00315	3/4-14	1/2-14
G60132-1212	12MP-12FPL	7259-06545	3/4-14	3/4-14
G60132-1216	12MP-16FPL	7259-25455	3/4-14	1-11 1/2
G60132-1612	16MP-12FPL	7259-05735	1-11 1/2	3/4-14
G60132-1616	16MP-16FPL	7259-08635	1-11 1/2	1-11 1/2
G60132-1620	16MP-20FPL	7259-25475	1-11 1/2	1 1/4-11 1/2
G60132-1624	16MP-24FPL	7259-08645	1-11 1/2	1 1/2-11 1/2
G60132-2020	20MP-20FPL	7259-07345	1 1/4-11 1/2	1 1/4-11 1/2

- EQUIPMENT
- HOSE/CPLG. SELECTION
- G8K COUPLINGS
- GLOBAL SPIRAL COUPLINGS
- STAINLESS STEEL SPIRAL
- MEGACRIMP COUPLINGS
- STAINLESS STEEL BRAID
- POWER CRIMP COUPLINGS
- FIELD ATTACHABLE G1 & G2 COUPLINGS
- FIELD ATTACHABLE C5 COUPLINGS
- C14 COUPLINGS
- GL COUPLINGS
- GLX COUPLINGS
- PCTS THERMOPLASTIC COUPLINGS
- POLARSEAL COUPLINGS (ACA)
- POLARSEAL II COUPLINGS (ACC)
- POLARSEAL II COUPLINGS (ACB)
- POWER STEERING
- ADAPTERS
- QUICK DISCONNECT COUPLERS
- BALL VALVES
- LIVE SWIVEL
- ASSEMBLY FABRICATION
- ACCESSORIES
- EQUIPMENT AND PARTS
- KITS
- AIR BRAKE HOSE ASSY
- BRASS



EQUIPMENT
HOSE/CPLG. SELECTION
G8K COUPLINGS
GLOBAL SPIRAL COUPLINGS
STAINLESS STEEL SPIRAL
MEGACRIMP COUPLINGS
STAINLESS STEEL BRAID
POWER CRIMP COUPLINGS
FIELD ATTACHABLE G1 & G2 COUPLINGS
FIELD ATTACHABLE C5 COUPLINGS
C14 COUPLINGS
GL COUPLINGS
GLX COUPLINGS
PCTS THERMOPLASTIC COUPLINGS
POLARSEAL COUPLINGS (ACA)
POLARSEAL II COUPLINGS (ACC)
POLARSEAL II COUPLINGS (ACB)
POWER STEERING
ADAPTERS
QUICK DISCONNECT COUPLERS
BALL VALVES
LIVE SWIVEL
ASSEMBLY FABRICATION
ACCESSORIES
EQUIPMENT AND PARTS
KITS
AIR BRAKE HOSE ASSY
BRASS

### Male Pipe NPTF to Female Pipe NPTF Increasing Bushing - Long - Continued

Part No.	Descr.	Prod. No.		
			"	"
G60132-2024	20MP-24FPL	7259-25495	1 1/4-11 1/2	1 1/2-11 1/2
G60132-2432	24MP-32FPL	7259-07765	1 1/2-11 1/2	2-11 1/2

### Female Pipe NPTF to Male Pipe NPTF - 45°

For use up to SAE 100R2 maximum working pressure.

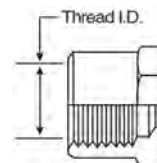
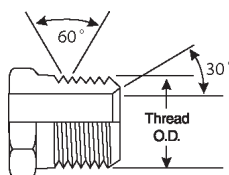
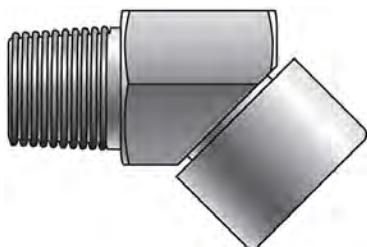

Part No.	Descr.	Prod. No.		
			"	"
G60134-0606	6FP-6MP45	7259-50465	3/8-18	3/8-18
G60134-0808	8FP-8MP45	7259-50475	1/2-14	1/2-14

### Male Pipe NPTF to Female Pipe NPTF - 90°

For use up to SAE 100R2 maximum working pressure.

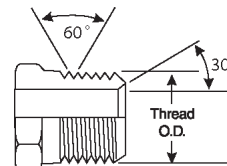
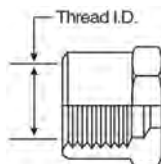
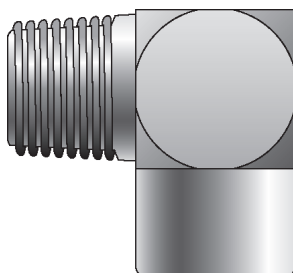

Part No.	Descr.	Prod. No.		
			"	"
G60136-0202	2MP-2FP90	7259-24105	1/8-27	1/8-27
G60136-0204	2MP-4FP90	7259-32835	1/8-27	1/4-18
G60136-0402	4MP-2FP90	7259-32845	1/4-18	1/8-27
G60136-0404	4MP-4FP90	7259-24115	1/4-18	1/4-18
G60136-0406	4MP-6FP90	7259-32855	1/4-18	3/8-18
G60136-0604	6MP-4FP90	7259-32865	3/8-18	1/4-18
G60136-0606	6MP-6FP90	7259-24125	3/8-18	3/8-18
G60136-0608	6MP-8FP90	7259-32875	3/8-18	1/2-14
G60136-0804	8MP-4FP90	7259-08655	1/2-14	1/4-18
G60136-0806	8MP-6FP90	7259-32885	1/2-14	3/8-18
G60136-0808	8MP-8FP90	7259-24135	1/2-14	1/2-14
G60136-0812	8MP-12FP90	7259-32895	1/2-14	3/4-14
G60136-1208	12MP-8FP90	7259-32905	3/4-14	1/2-14





### Male Pipe NPTF to Female Pipe NPTF - 90° - Continued

Part No.	Descr.	Prod. No.		
			"	"
G60136-1212	12MP-12FP90	7259-24145	3/4-14	3/4-14
G60136-1216	12MP-16FP90	7259-08375	3/4-14	1-11 1/2
G60136-1612	16MP-12FP90	7259-08155	1-11 1/2	3/4-14
G60136-1616	16MP-16FP90	7259-24155	1-11 1/2	1-11 1/2
G60136-2016	20MP-16FP90	7259-08665	1 1/4-11 1/2	1-11 1/2
G60136-2020	20MP-20FP90	7259-24165	1 1/4-11 1/2	1 1/4-11 1/2
G60136-2424	24MP-24FP90	7259-24175	1 1/2-11 1/2	1 1/2-11 1/2
G60136-3232	32MP-32FP90	7259-24185	2-11 1/2	2-11 1/2

### Male Pipe NPTF to Female Pipe Swivel NPSM

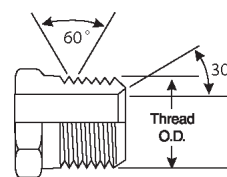
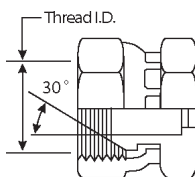
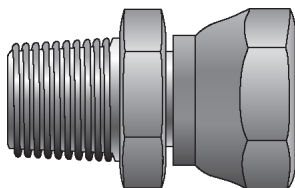
For use up to SAE 100R2 maximum working pressure.



Part No.	Descr.	Prod. No.		
			"	"
G60140-0202	2MP-2FPX	7259-00735	1/8-27	1/8-27
G60140-0204	2MP-4FPX	7259-10635	1/8-27	1/4-18
G60140-0402	4MP-2FPX	7259-05095	1/4-18	1/8-27
G60140-0404	4MP-4FPX	7259-00775	1/4-18	1/4-18
G60140-0406	4MP-6FPX	7259-10455	1/4-18	3/8-18
G60140-0408	4MP-8FPX	7259-07355	1/4-18	1/2-14
G60140-0604	6MP-4FPX	7259-10625	3/8-18	1/4-18
G60140-0606	6MP-6FPX	7259-00815	3/8-18	3/8-18
G60140-0608	6MP-8FPX	7259-10375	3/8-18	1/2-14
G60140-0806	8MP-6FPX	7259-10365	1/2-14	3/8-18
G60140-0808	8MP-8FPX	7259-00895	1/2-14	1/2-14
G60140-0812	8MP-12FPX	7259-10865	1/2-14	3/4-14
G60140-1206	12MP-6FPX	7259-06345	3/4-14	3/8-18
G60140-1208	12MP-8FPX	7259-10645	3/4-14	1/2-14
G60140-1212	12MP-12FPX	7259-00255	3/4-14	3/4-14
G60140-1216	12MP-16FPX	7259-32935	3/4-14	1-11 1/2
G60140-1220	12MP-20FPX	7259-08675	3/4-14	1 1/4-11 1/2
G60140-1612	16MP-12FPX	7259-10935	1-11 1/2	3/4-14
G60140-1616	16MP-16FPX	7259-00275	1-11 1/2	1-11 1/2
G60140-1620	16MP-20FPX	7259-11285	1-11 1/2	1 1/4-11 1/2
G60140-2016	20MP-16FPX	7259-05595	1 1/4-11 1/2	1-11 1/2
G60140-2020	20MP-20FPX	7259-10745	1 1/4-11 1/2	1 1/4-11 1/2
G60140-2024	20MP-24FPX	7259-06375	1 1/4-11 1/2	1 1/2-11 1/2
G60140-2420	24MP-20FPX	7259-06305	1 1/2-11 1/2	1 1/4-11 1/2
G60140-2424	24MP-24FPX	7259-11345	1 1/2-11 1/2	1 1/2-11 1/2
G60140-3232	32MP-32FPX	7259-11435	2-11 1/2	2-11 1/2

- EQUIPMENT
- HOSE/CPLG. SELECTION
- G8K COUPLINGS
- GLOBAL SPIRAL COUPLINGS
- STAINLESS STEEL SPIRAL
- MEGACRIMP COUPLINGS
- STAINLESS STEEL BRAID
- POWER CRIMP COUPLINGS
- FIELD ATTACHABLE G1 & G2 COUPLINGS
- FIELD ATTACHABLE C5 COUPLINGS
- C14 COUPLINGS
- GL COUPLINGS
- GLX COUPLINGS
- PCTS THERMOPLASTIC COUPLINGS
- POLARSEAL COUPLINGS (ACA)
- POLARSEAL II COUPLINGS (ACC)
- POLARSEAL II COUPLINGS (ACB)
- POWER STEERING
- ADAPTERS
- QUICK DISCONNECT COUPLERS
- BALL VALVES
- LIVE SWIVEL
- ASSEMBLY FABRICATION
- ACCESSORIES
- EQUIPMENT AND PARTS
- KITS
- AIR BRAKE HOSE ASSY
- BRASS





## Male Pipe NPTF to Female Pipe Swivel NPSM - 45°

For use up to SAE 100R2 maximum working pressure.

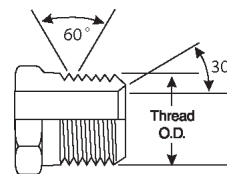
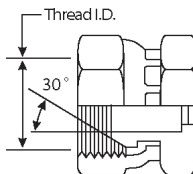
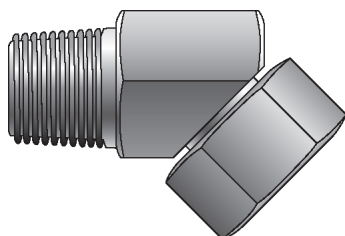

Part No.	Descr.	Prod. No.		
			"	"
G60142-0202	2MP-2FPX45	7259-32945	1/8-27	1/8-27
G60142-0204	2MP-4FPX45	7259-00505	1/8-27	1/4-18
G60142-0402	4MP-2FPX45	7259-05985	1/4-18	1/8-27
G60142-0404	4MP-4FPX45	7259-02115	1/4-18	1/4-18
G60142-0406	4MP-6FPX45	7259-05265	1/4-18	3/8-18
G60142-0604	6MP-4FPX45	7259-05555	3/8-18	1/4-18
G60142-0606	6MP-6FPX45	7259-02155	3/8-18	3/8-18
G60142-0608	6MP-8FPX45	7259-32955	3/8-18	1/2-14
G60142-0804	8MP-4FPX45	7259-06465	1/2-14	1/4-18
G60142-0806	8MP-6FPX45	7259-32965	1/2-14	3/8-18
G60142-0808	8MP-8FPX45	7259-02125	1/2-14	1/2-14
G60142-0812	8MP-12FPX45	7259-06115	1/2-14	3/4-14
G60142-1208	12MP-8FPX45	7259-11535	3/4-14	1/2-14
G60142-1212	12MP-12FPX45	7259-02235	3/4-14	3/4-14
G60142-1216	12MP-16FPX45	7259-06125	3/4-14	1-11 1/2
G60142-1612	16MP-12FPX45	7259-11625	1-11 1/2	3/4-14
G60142-1616	16MP-16FPX45	7259-10765	1-11 1/2	1-11 1/2
G60142-1620	16MP-20FPX45	7259-07855	1-11 1/2	1 1/4-11 1/2
G60142-2016	20MP-16FPX45	7259-06685	1 1/4-11 1/2	1-11 1/2
G60142-2020	20MP-20FPX45	7259-11355	1 1/4-11 1/2	1 1/4-11 1/2
G60142-2424	24MP-24FPX45	7259-11745	1 1/2-11 1/2	1 1/2-11 1/2
G60142-3232	32MP-32FPX45	7259-32975	2-11 1/2	2-11 1/2

## Male Pipe NPTF to Female Pipe Swivel NPSM - 90°

For use up to SAE 100R2 maximum working pressure.

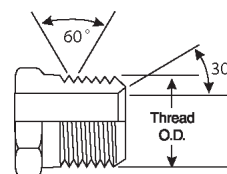
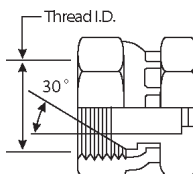
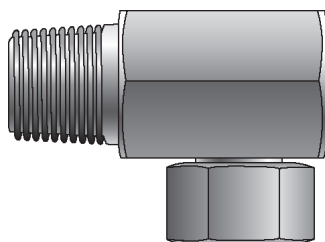

Part No.	Descr.	Prod. No.		
			"	"
G60144-0202	2MP-2FPX90	7259-08305	1/8-27	1/8-27
G60144-0204	2MP-4FPX90	7259-00415	1/8-27	1/4-18
G60144-0402	4MP-2FPX90	7259-05565	1/4-18	1/8-27
G60144-0404	4MP-4FPX90	7259-02135	1/4-18	1/4-18
G60144-0406	4MP-6FPX90	7259-10705	1/4-18	3/8-18





Male Pipe NPTF to Female Pipe Swivel NPSM - 90° - Continued

Part No.	Descr.	Prod. No.		
			"	"
G60144-0408	4MP-8FPX90	7259-08685	1/4-18	1/2-14
G60144-0604	6MP-4FPX90	7259-10525	3/8-18	1/4-18
G60144-0606	6MP-6FPX90	7259-02165	3/8-18	3/8-18
G60144-0608	6MP-8FPX90	7259-10325	3/8-18	1/2-14
G60144-0804	8MP-4FPX90	7259-11175	1/2-14	1/4-18
G60144-0806	8MP-6FPX90	7259-10265	1/2-14	3/8-18
G60144-0808	8MP-8FPX90	7259-02205	1/2-14	1/2-14
G60144-0812	8MP-12FPX90	7259-11075	1/2-14	3/4-14
G60144-1206	12MP-6FPX90	7259-06045	3/4-14	3/8-18
G60144-1208	12MP-8FPX90	7259-02245	3/4-14	1/2-14
G60144-1212	12MP-12FPX90	7259-02265	3/4-14	3/4-14
G60144-1216	12MP-16FPX90	7259-05195	3/4-14	1-11 1/2
G60144-1220	12MP-20FPX90	7259-08705	3/4-14	1 1/4-11 1/2
G60144-1608	16MP-8FPX90	7259-06775	1-11 1/2	1/2-14
G60144-1612	16MP-12FPX90	7259-11275	1-11 1/2	3/4-14
G60144-1616	16MP-16FPX90	7259-10335	1-11 1/2	1-11 1/2
G60144-1620	16MP-20FPX90	7259-11475	1-11 1/2	1 1/4-11 1/2
G60144-2012	20MP-12FPX90	7259-08165	1 1/4-11 1/2	3/4-14
G60144-2016	20MP-16FPX90	7259-05435	1 1/4-11 1/2	1-11 1/2
G60144-2020	20MP-20FPX90	7259-11055	1 1/4-11 1/2	1 1/4-11 1/2
G60144-2024	20MP-24FPX90	7259-07865	1 1/4-11 1/2	1 1/2-11 1/2
G60144-2420	24MP-20FPX90	7259-06355	1 1/2-11 1/2	1 1/4-11 1/2
G60144-2424	24MP-24FPX90	7259-11655	1 1/2-11 1/2	1 1/2-11 1/2
G60144-3232	32MP-32FPX90	7259-32995	2-11 1/2	2-11 1/2

Female Pipe NPTF to Female Pipe NPTF

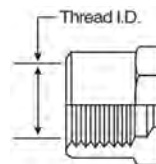
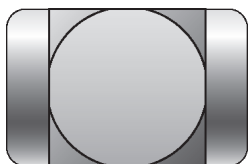
For use up to SAE 100R2 maximum working pressure.



Part No.	Descr.	Prod. No.		
			"	"
G60152-0202	2FP-2FP	7259-24415	1/8-27	1/8-27
G60152-0402	4FP-2FP	7259-05035	1/4-18	1/8-27
G60152-0404	4FP-4FP	7259-24425	1/4-18	1/4-18
G60152-0602	6FP-2FP	7259-08385	3/8-18	1/8-27
G60152-0604	6FP-4FP	7259-00495	3/8-18	1/4-18
G60152-0606	6FP-6FP	7259-24435	3/8-18	3/8-18
G60152-0804	8FP-4FP	7259-05575	1/2-14	1/4-18
G60152-0806	8FP-6FP	7259-00715	1/2-14	3/8-18
G60152-0808	8FP-8FP	7259-24445	1/2-14	1/2-14
G60152-1208	12FP-8FP	7259-00525	3/4-14	1/2-14
G60152-1212	12FP-12FP	7259-24455	3/4-14	3/4-14
G60152-1608	16FP-8FP	7259-08715	1-11 1/2	1/2-14
G60152-1612	16FP-12FP	7259-05745	1-11 1/2	3/4-14
G60152-1616	16FP-16FP	7259-24465	1-11 1/2	1-11 1/2
G60152-2016	20FP-16FP	7259-08395	1 1/4-11 1/2	1-11 1/2
G60152-2020	20FP-20FP	7259-24475	1 1/4-11 1/2	1 1/4-11 1/2

- EQUIPMENT
- HOSE/CPLG. SELECTION
- G8K COUPLINGS
- GLOBAL SPIRAL COUPLINGS
- STAINLESS STEEL SPIRAL
- MEGACRIMP COUPLINGS
- STAINLESS STEEL BRAID
- POWER CRIMP COUPLINGS
- FIELD ATTACHABLE G1 & G2 COUPLINGS
- FIELD ATTACHABLE C5 COUPLINGS
- C14 COUPLINGS
- GL COUPLINGS
- GLX COUPLINGS
- PCTS THERMOPLASTIC COUPLINGS
- POLARSEAL COUPLINGS (ACA)
- POLARSEAL II COUPLINGS (ACC)
- POLARSEAL II COUPLINGS (ACB)
- POWER STEERING
- ADAPTERS
- QUICK DISCONNECT COUPLERS
- BALL VALVES
- LIVE SWIVEL
- ASSEMBLY FABRICATION
- ACCESSORIES
- EQUIPMENT AND PARTS
- KITS
- AIR BRAKE HOSE ASSY
- BRASS



EQUIPMENT
HOSE/CPLG. SELECTION
G8K COUPLINGS
GLOBAL SPIRAL COUPLINGS
STAINLESS STEEL SPIRAL
MEGACRIMP COUPLINGS
STAINLESS STEEL BRAID
POWER CRIMP COUPLINGS
FIELD ATTACHABLE G1 & G2 COUPLINGS
FIELD ATTACHABLE C5 COUPLINGS
C14 COUPLINGS
GL COUPLINGS
GLX COUPLINGS
PCTS THERMOPLASTIC COUPLINGS
POLARSEAL COUPLINGS (ACA)
POLARSEAL II COUPLINGS (ACC)
POLARSEAL II COUPLINGS (ACB)
POWER STEERING
ADAPTERS
QUICK DISCONNECT COUPLERS
BALL VALVES
LIVE SWIVEL
ASSEMBLY FABRICATION
ACCESSORIES
EQUIPMENT AND PARTS
KITS
AIR BRAKE HOSE ASSY
BRASS

### Female Pipe NPTF to Female Pipe NPTF - Continued

Part No.	Descr.	Prod. No.		
			"	"
G60152-2424	24FP-24FP	7259-24885	1 1/2-11 1/2	1 1/2-11 1/2
G60152-3232	32FP-32FP	7259-24895	2-11 1/2	2-11 1/2

### Female Pipe NPTF to Female Pipe NPTF - 90°

For use up to SAE 100R2 maximum working pressure.

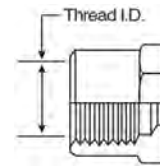
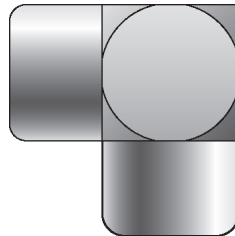

Part No.	Descr.	Prod. No.		
			"	"
G60156-0202	2FP-2FP90	7259-25015	1/8-27	1/8-27
G60156-0402	4FP-2FP90	7259-33005	1/4-18	1/8-27
G60156-0404	4FP-4FP90	7259-25025	1/4-18	1/4-18
G60156-0604	6FP-4FP90	7259-33015	3/8-18	1/4-18
G60156-0606	6FP-6FP90	7259-25035	3/8-18	3/8-18
G60156-0804	8FP-4FP90	7259-08725	1/2-14	1/4-18
G60156-0806	8FP-6FP90	7259-33025	1/2-14	3/8-18
G60156-0808	8FP-8FP90	7259-25045	1/2-14	1/2-14
G60156-1208	12FP-8FP90	7259-33035	3/4-14	1/2-14
G60156-1212	12FP-12FP90	7259-25055	3/4-14	3/4-14
G60156-1612	16FP-12FP90	7259-08175	1-11 1/2	3/4-14
G60156-1616	16FP-16FP90	7259-25065	1-11 1/2	1-11 1/2
G60156-2020	20FP-20FP90	7259-25075	1 1/4-11 1/2	1 1/4-11 1/2
G60156-2424	24FP-24FP90	7259-33055	1 1/2-11 1/2	1 1/2-11 1/2
G60156-3232	32FP-32FP90	7259-07485	2-11 1/2	2-11 1/2

### Female Pipe NPTF to Female Pipe Swivel NPSM

For use up to SAE 100R2 maximum working pressure.

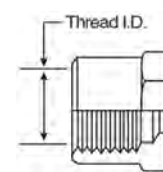
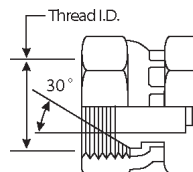
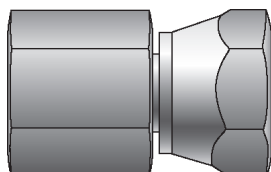

Part No.	Descr.	Prod. No.		
			"	"
G60160-0202	2FP-2FPX	7259-33065	1/8-27	1/8-27
G60160-0204	2FP-4FPX	7259-00435	1/8-27	1/4-18
G60160-0402	4FP-2FPX	7259-07515	1/4-18	1/8-27
G60160-0404	4FP-4FPX	7259-00795	1/4-18	1/4-18





### Female Pipe NPTF to Female Pipe Swivel NPSM - Continued

Part No.	Descr.	Prod. No.		
			"	"
G60160-0406	4FP-6FPX	7259-05205	1/4-18	3/8-18
G60160-0604	6FP-4FPX	7259-33085	3/8-18	1/4-18
G60160-0606	6FP-6FPX	7259-00835	3/8-18	3/8-18
G60160-0608	6FP-8FPX	7259-05105	3/8-18	1/2-14
G60160-0804	8FP-4FPX	7259-08735	1/2-14	1/4-18
G60160-0806	8FP-6FPX	7259-33095	1/2-14	3/8-18
G60160-0808	8FP-8FPX	7259-00915	1/2-14	1/2-14
G60160-0812	8FP-12FPX	7259-06695	1/2-14	3/4-14
G60160-1208	12FP-8FPX	7259-07165	3/4-14	1/2-14
G60160-1212	12FP-12FPX	7259-00925	3/4-14	3/4-14
G60160-1216	12FP-16FPX	7259-07775	3/4-14	1-11 1/2
G60160-1612	16FP-12FPX	7259-11595	1-11 1/2	3/4-14
G60160-1616	16FP-16FPX	7259-00905	1-11 1/2	1-11 1/2
G60160-2020	20FP-20FPX	7259-11015	1 1/4-11 1/2	1 1/4-11 1/2
G60160-2424	24FP-24FPX	7259-11545	1 1/2-11 1/2	1 1/2-11 1/2
G60160-3232	32FP-32FPX	7259-11725	2-11 1/2	2-11 1/2

### Female Pipe NPTF to Female Pipe Swivel NPSM - 45°

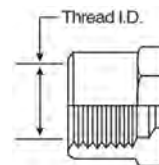
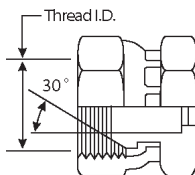
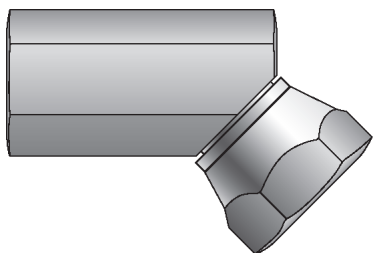
For use up to SAE 100R2 maximum working pressure.



Part No.	Descr.	Prod. No.		
			"	"
G60162-0202	2FP-2FPX45	7259-06145	1/8-27	1/8-27
G60162-0204	2FP-4FPX45	7259-08745	1/8-27	1/4-18
G60162-0404	4FP-4FPX45	7259-11575	1/4-18	1/4-18
G60162-0604	6FP-4FPX45	7259-06785	3/8-18	1/4-18
G60162-0606	6FP-6FPX45	7259-11455	3/8-18	3/8-18
G60162-0608	6FP-8FPX45	7259-08185	3/8-18	1/2-14
G60162-0806	8FP-6FPX45	7259-06415	1/2-14	3/8-18
G60162-0808	8FP-8FPX45	7259-11305	1/2-14	1/2-14
G60162-1212	12FP-12FPX45	7259-11325	3/4-14	3/4-14
G60162-1612	16FP-12FPX45	7259-06565	1-11 1/2	3/4-14
G60162-1616	16FP-16FPX45	7259-11515	1-11 1/2	1-11 1/2
G60162-2020	20FP-20FPX45	7259-33105	1 1/4-11 1/2	1 1/4-11 1/2

- EQUIPMENT
- HOSE/CPLG. SELECTION
- G8K COUPLINGS
- GLOBAL SPIRAL COUPLINGS
- STAINLESS STEEL SPIRAL
- MEGACRIMP COUPLINGS
- STAINLESS STEEL BRAID
- POWER CRIMP COUPLINGS
- FIELD ATTACHABLE G1 & G2 COUPLINGS
- FIELD ATTACHABLE C5 COUPLINGS
- C14 COUPLINGS
- GL COUPLINGS
- GLX COUPLINGS
- PCTS THERMOPLASTIC COUPLINGS
- POLARSEAL COUPLINGS (ACA)
- POLARSEAL II COUPLINGS (ACC)
- POLARSEAL II COUPLINGS (ACB)
- POWER STEERING
- ADAPTERS
- QUICK DISCONNECT COUPLERS
- BALL VALVES
- LIVE SWIVEL
- ASSEMBLY FABRICATION
- ACCESSORIES
- EQUIPMENT AND PARTS
- KITS
- AIR BRAKE HOSE ASSY
- BRASS



## Female Pipe NPTF to Female Pipe Swivel NPSM - 90°

For use up to SAE 100R2 maximum working pressure.

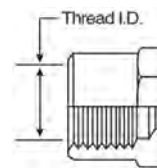
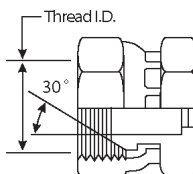
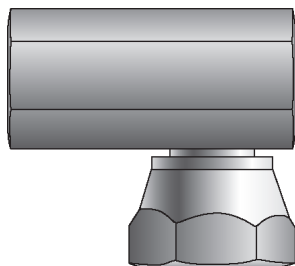

Part No.	Descr.	Prod. No.		
			"	"
G60164-0202	2FP-2FPX90	7259-05475	1/8-27	1/8-27
G60164-0204	2FP-4FPX90	7259-08755	1/8-27	1/4-18
G60164-0402	4FP-2FPX90	7259-06285	1/4-18	1/8-27
G60164-0404	4FP-4FPX90	7259-11005	1/4-18	1/4-18
G60164-0406	4FP-6FPX90	7259-06245	1/4-18	3/8-18
G60164-0604	6FP-4FPX90	7259-06825	3/8-18	1/4-18
G60164-0606	6FP-6FPX90	7259-10955	3/8-18	3/8-18
G60164-0608	6FP-8FPX90	7259-06965	3/8-18	1/2-14
G60164-0806	8FP-6FPX90	7259-06855	1/2-14	3/8-18
G60164-0808	8FP-8FPX90	7259-10615	1/2-14	1/2-14
G60164-0812	8FP-12FPX90	7259-06485	1/2-14	3/4-14
G60164-1208	12FP-8FPX90	7259-06585	3/4-14	1/2-14
G60164-1212	12FP-12FPX90	7259-11095	3/4-14	3/4-14
G60164-1612	16FP-12FPX90	7259-06595	1-11 1/2	3/4-14
G60164-1616	16FP-16FPX90	7259-11765	1-11 1/2	1-11 1/2
G60164-2016	20FP-16FPX90	7259-08405	1 1/4-11 1/2	1-11 1/2
G60164-2020	20FP-20FPX90	7259-33115	1 1/4-11 1/2	1 1/4-11 1/2
G60164-2424	24FP-24FPX90	7259-33125	1 1/2-11 1/2	1 1/2-11 1/2
G60164-3232	32FP-32FPX90	7259-33135	2-11 1/2	2-11 1/2

## Female Pipe NPTF - Tee

For use up to SAE 100R2 maximum working pressure.

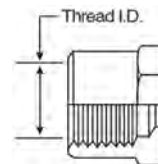
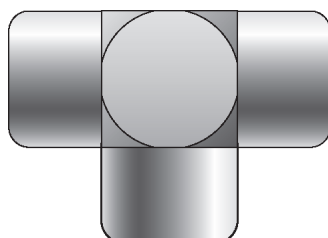

Part No.	Descr.	Prod. No.			
			"	"	"
G60181-0202	2FP-2FP-2FP	7259-23145	1/8-27	1/8-27	1/8-27
G60181-0404	4FP-4FP-4FP	7259-23155	1/4-18	1/4-18	1/4-18
G60181-0606	6FP-6FP-6FP	7259-23165	3/8-18	3/8-18	3/8-18
G60181-0808	8FP-8FP-8FP	7259-23175	1/2-14	1/2-14	1/2-14
G60181-1212	12FP-12FP-12FP	7259-23185	3/4-14	3/4-14	3/4-14
G60181-1616	16FP-16FP-16FP	7259-23195	1-11 1/2	1-11 1/2	1-11 1/2
G60181-2020	20FP-20FP-20FP	7259-33145	1 1/4-11 1/2	1 1/4-11 1/2	1 1/4-11 1/2





### Female Pipe NPTF - Tee - Continued

Part No.	Descr.	Prod. No.			
			"	"	"
G60181-2424	24FP-24FP-24FP	7259-33155	1 1/2-11 1/2	1 1/2-11 1/2	1 1/2-11 1/2
G60181-3232	32FP-32FP-32FP	7259-07245	2-11 1/2	2-11 1/2	2-11 1/2

### Female Pipe NPTF on Run to Male Pipe NPTF - Tee

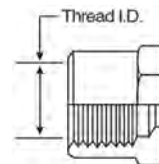
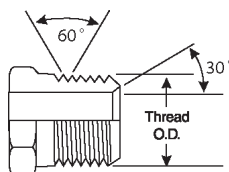
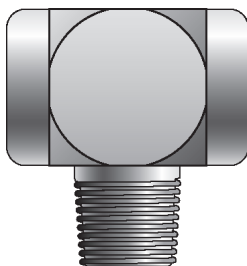
For use up to SAE 100R2 maximum working pressure.



Part No.	Descr.	Prod. No.			
			"	"	"
G60183-0202	2FP-2FP-2MP	7259-24905	1/8-27	1/8-27	1/8-27
G60183-0404	4FP-4FP-4MP	7259-24915	1/4-18	1/4-18	1/4-18
G60183-0606	6FP-6FP-6MP	7259-24925	3/8-18	3/8-18	3/8-18
G60183-0808	8FP-8FP-8MP	7259-24935	1/2-14	1/2-14	1/2-14
G60183-1212	12FP-12FP-12MP	7259-24945	3/4-14	3/4-14	3/4-14
G60183-1616	16FP-16FP-16MP	7259-24955	1-11 1/2	1-11 1/2	1-11 1/2
G60183-2020	20FP-20FP-20MP	7259-07875	1 1/4-11 1/2	1 1/4-11 1/2	1 1/4-11 1/2
G60183-2424	24FP-24FP-24MP	7259-08765	1 1/2-11 1/2	1 1/2-11 1/2	1 1/2-11 1/2

### Female Pipe Swivel NPSM - Tee

For use up to SAE 100R2 maximum working pressure.

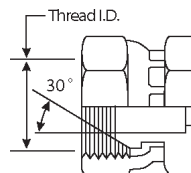
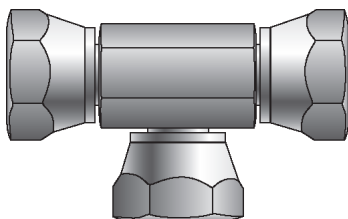

Part No.	Descr.	Prod. No.			
			"	"	"
G60184-0202	2FPX-2FPX-2FPX	7253-33165	1/8-27	1/8-27	1/8-27
G60184-0404	4FPX-4FPX-4FPX	7253-33175	1/4-18	1/4-18	1/4-18
G60184-0606	6FPX-6FPX-6FPX	7253-33185	3/8-18	3/8-18	3/8-18
G60184-0808	8FPX-8FPX-8FPX	7259-33195	1/2-14	1/2-14	1/2-14
G60184-1212	12FPX-12FPX-12FPX	7259-33205	3/4-14	3/4-14	3/4-14
G60184-1616	16FPX-16FPX-16FPX	7253-33215	1-11 1/2	1-11 1/2	1-11 1/2
G60184-2020	20FPX-20FPX-20FPX	7253-33225	1 1/4-11 1/2	1 1/4-11 1/2	1 1/4-11 1/2

EQUIPMENT
HOSE/CPLG. SELECTION
G8K COUPLINGS
GLOBAL SPIRAL COUPLINGS
STAINLESS STEEL SPIRAL
MEGACRIMP COUPLINGS
STAINLESS STEEL BRAID
POWER CRIMP COUPLINGS
FIELD ATTACHABLE G1 & G2 COUPLINGS
FIELD ATTACHABLE C5 COUPLINGS
C14 COUPLINGS
GL COUPLINGS
GLX COUPLINGS
PCTS THERMOPLASTIC COUPLINGS
POLARSEAL COUPLINGS (ACA)
POLARSEAL II COUPLINGS (ACC)
POLARSEAL II COUPLINGS (ACB)
POWER STEERING
ADAPTERS
QUICK DISCONNECT COUPLERS
BALL VALVES
LIVE SWIVEL
ASSEMBLY FABRICATION
ACCESSORIES
EQUIPMENT AND PARTS
KITS
AIR BRAKE HOSE ASSY
BRASS



## Female Pipe Swivel NPSM on Run to Male Pipe NPTF - Tee

For use up to SAE 100R2 maximum working pressure.

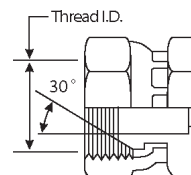
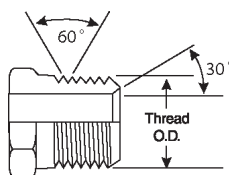
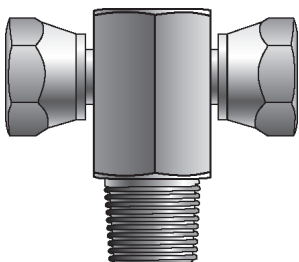

Part No.	Descr.	Prod. No.			
			"	"	"
G60186-0202	2FPX-2FPX-2MP	7253-86585	1/8-27	1/8-27	1/8-27
G60186-0404	4FPX-4FPX-4MP	7253-86586	1/4-18	1/4-18	1/4-18
G60186-0606	6FPX-6FPX-6MP	7253-86587	3/8-18	3/8-18	3/8-18
G60186-0808	8FPX-8FPX-8MP	7253-86588	1/2-14	1/2-14	1/2-14
G60186-1212	12FPX-12FPX-12MP	7253-86589	3/4-14	3/4-14	3/4-14
G60186-1616	16FPX-16FPX-16MP	7253-86591	1-11 1/2	1-11 1/2	1-11 1/2
G60186-2020	20FPX-20FPX-20MP	7253-33235	1 1/4-11 1/2	1 1/4-11 1/2	1 1/4-11 1/2
G60186-2424	24FPX-24FPX-24MP	7259-07605	1 1/2-11 1/2	1 1/2-11 1/2	1 1/2-11 1/2

## Male O-Ring Boss Plug

For use up to SAE 100R2 maximum working pressure.

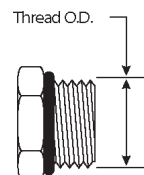
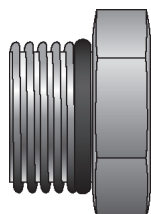

Part No.	Descr.	Prod. No.	
			"
G60250-0002	2MB-PLUG	7259-05415	5/16-24
G60250-0003	3MB-PLUG	7259-05255	3/8-24
G60250-0004	4MB-PLUG	7259-22975	7/16-20
G60250-0005	5MB-PLUG	7259-22985	1/2-20
G60250-0006	6MB-PLUG	7259-22995	9/16-18
G60250-0008	8MB-PLUG	7259-23005	3/4-16
G60250-0010	10MB-PLUG	7259-23015	7/8-14
G60250-0012	12MB-PLUG	7259-23025	1 1/16-12
G60250-0014	14MB-PLUG	7259-23035	1 3/16-12
G60250-0016	16MB-PLUG	7259-23045	1 5/16-12
G60250-0020	20MB-PLUG	7259-23055	1 5/8-12
G60250-0024	24MB-PLUG	7259-05185	1 7/8-12
G60250-0032	32MB-PLUG	7259-07615	2 1/2-12

EQUIPMENT
HOSE/CPLG. SELECTION
G8K COUPLINGS
GLOBAL SPIRAL COUPLINGS
STAINLESS STEEL SPIRAL
MEGACRIMP COUPLINGS
STAINLESS STEEL BRAID
POWER CRIMP COUPLINGS
FIELD ATTACHABLE G1 & G2 COUPLINGS
FIELD ATTACHABLE C5 COUPLINGS
C14 COUPLINGS
GL COUPLINGS
GLX COUPLINGS
PCTS THERMOPLASTIC COUPLINGS
POLARSEAL COUPLINGS (ACA)
POLARSEAL II COUPLINGS (ACC)
POLARSEAL II COUPLINGS (ACB)
POWER STEERING
ADAPTERS
QUICK DISCONNECT COUPLERS
BALL VALVES
LIVE SWIVEL
ASSEMBLY FABRICATION
ACCESSORIES
EQUIPMENT AND PARTS
KITS
AIR BRAKE HOSE ASSY
BRASS





### Male O-Ring Boss to Male Pipe NPTF

For use up to SAE 100R2 maximum working pressure.

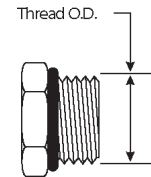
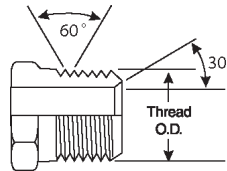

Part No.	Descr.	Prod. No.		
			"	"
G60265-0808	8MB-8MP	7259-50725	3/4-16	1/2-14
G60265-1008	10MB-8MP	7259-50735	7/8-14	1/2-14

### Male O-Ring Boss to Female Pipe NPTF

For use up to SAE 100R2 maximum working pressure.

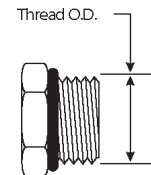
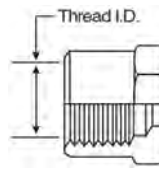
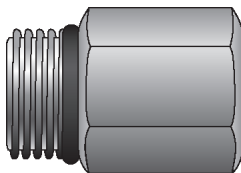

Part No.	Descr.	Prod. No.		
			"	"
G60275-0302	3MB-2FP	7259-08785	3/8-24	1/8-27
G60275-0402	4MB-2FP	7259-24205	7/16-20	1/8-27
G60275-0404	4MB-4FP	7259-00395	7/16-20	1/4-18
G60275-0406	4MB-6FP	7259-05145	7/16-20	3/8-18
G60275-0502	5MB-2FP	7259-05945	1/2-20	1/8-27
G60275-0504	5MB-4FP	7259-05755	1/2-20	1/4-18
G60275-0602	6MB-2FP	7259-08805	9/16-18	1/8-27
G60275-0604	6MB-4FP	7259-24215	9/16-18	1/4-18
G60275-0606	6MB-6FP	7259-00205	9/16-18	3/8-18
G60275-0608	6MB-8FP	7259-06605	9/16-18	1/2-14
G60275-0804	8MB-4FP	7259-00245	3/4-16	1/4-18
G60275-0806	8MB-6FP	7259-24225	3/4-16	3/8-18
G60275-0808	8MB-8FP	7259-33255	3/4-16	1/2-14
G60275-0812	8MB-12FP	7259-06715	3/4-16	3/4-14
G60275-1004	10MB-4FP	7259-07255	7/8-14	1/4-18
G60275-1006	10MB-6FP	7259-00335	7/8-14	3/8-18
G60275-1008	10MB-8FP	7259-24235	7/8-14	1/2-14
G60275-1012	10MB-12FP	7259-05315	7/8-14	3/4-14
G60275-1208	12MB-8FP	7259-24245	1 1/16-12	1/2-14
G60275-1212	12MB-12FP	7259-24255	1 1/16-12	3/4-14
G60275-1216	12MB-16FP	7259-06155	1 1/16-12	1-11 1/2
G60275-1412	14MB-12FP	7259-24265	1 3/16-12	3/4-14
G60275-1608	16MB-8FP	7259-05495	1 5/16-12	1/2-14
G60275-1612	16MB-12FP	7259-33265	1 5/16-12	3/4-14
G60275-1616	16MB-16FP	7259-24275	1 5/16-12	1-11 1/2
G60275-2016	20MB-16FP	7259-05445	1 5/8-12	1-11 1/2

- EQUIPMENT
- HOSE/CPLG. SELECTION
- G8K COUPLINGS
- GLOBALSPIRAL COUPLINGS
- STAINLESS STEEL SPIRAL
- MEGACRIMP COUPLINGS
- STAINLESS STEEL BRAID
- POWER CRIMP COUPLINGS
- FIELD ATTACHABLE G1 & G2 COUPLINGS
- FIELD ATTACHABLE C5 COUPLINGS
- C14 COUPLINGS
- GL COUPLINGS
- GLX COUPLINGS
- PCTS THERMOPLASTIC COUPLINGS
- POLARSEAL COUPLINGS (ACA)
- POLARSEAL II COUPLINGS (ACC)
- POLARSEAL II COUPLINGS (ACB)
- POWER STEERING
- ADAPTERS**
- QUICK DISCONNECT COUPLERS
- BALL VALVES
- LIVE SWIVEL
- ASSEMBLY FABRICATION
- ACCESSORIES
- EQUIPMENT AND PARTS
- KITS
- AIR BRAKE HOSE ASSY
- BRASS



## Male O-Ring Boss to Female Pipe Swivel NPSM

For use up to SAE 100R2 maximum working pressure.

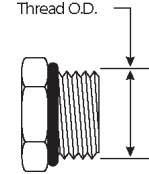
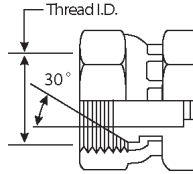
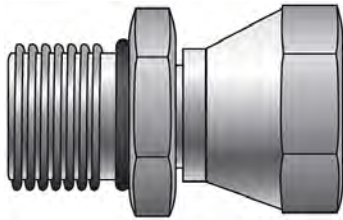

Part No.	Descr.	Prod. No.	Thread	
			"	"
G60285-0402	4MB-2FPX	7259-06725	7/16-20	1/8-27
G60285-0404	4MB-4FPX	7259-10475	7/16-20	1/4-18
G60285-0406	4MB-6FPX	7259-05395	7/16-20	3/8-18
G60285-0504	5MB-4FPX	7259-11065	1/2-20	1/4-18
G60285-0508	5MB-8FPX	7259-11735	1/2-20	1/2-14
G60285-0604	6MB-4FPX	7259-10585	9/16-18	1/4-18
G60285-0606	6MB-6FPX	7259-10445	9/16-18	3/8-18
G60285-0608	6MB-8FPX	7259-07495	9/16-18	1/2-14
G60285-0804	8MB-4FPX	7259-11115	3/4-16	1/4-18
G60285-0806	8MB-6FPX	7259-10535	3/4-16	3/8-18
G60285-0808	8MB-8FPX	7259-00295	3/4-16	1/2-14
G60285-0812	8MB-12FPX	7259-11105	3/4-16	3/4-14
G60285-1006	10MB-6FPX	7259-11155	7/8-14	3/8-18
G60285-1008	10MB-8FPX	7259-10215	7/8-14	1/2-14
G60285-1012	10MB-12FPX	7259-10665	7/8-14	3/4-14
G60285-1208	12MB-8FPX	7259-10725	1 1/16-12	1/2-14
G60285-1212	12MB-12FPX	7259-10315	1 1/16-12	3/4-14
G60285-1216	12MB-16FPX	7259-05535	1 1/16-12	1-11 1/2
G60285-1412	14MB-12FPX	7259-33275	1 3/16-12	3/4-14
G60285-1612	16MB-12FPX	7259-05115	1 5/16-12	3/4-14
G60285-1616	16MB-16FPX	7259-33285	1 5/16-12	1-11 1/2
G60285-1620	16MB-20FPX	7259-08035	1 5/16-12	1 1/4-11 1/2
G60285-2012	20MB-12FPX	7259-08815	1 5/8-12	3/4-14
G60285-2016	20MB-16FPX	7259-06925	1 5/8-12	1-11 1/2
G60285-2020	20MB-20FPX	7259-05605	1 5/8-12	1 1/4-11 1/2
G60285-2420	24MB-20FPX	7259-08825	1 7/8-12	1 1/4-11 1/2
G60285-2424	24MB-24FPX	7259-07625	1 7/8-12	1 1/2-11 1/2
G60285-3232	32MB-32FPX	7259-07885	2 1/2-12	2-11 1/2

EQUIPMENT
HOSE/CPLG. SELECTION
G8K COUPLINGS
GLOBAL SPIRAL COUPLINGS
STAINLESS STEEL SPIRAL
MEGACRIMP COUPLINGS
STAINLESS STEEL BRAID
POWER CRIMP COUPLINGS
FIELD ATTACHABLE G1 & G2 COUPLINGS
FIELD ATTACHABLE C5 COUPLINGS
C14 COUPLINGS
GL COUPLINGS
GLX COUPLINGS
PCTS THERMOPLASTIC COUPLINGS
POLARSEAL COUPLINGS (ACA)
POLARSEAL II COUPLINGS (ACC)
POLARSEAL II COUPLINGS (ACB)
POWER STEERING
ADAPTERS
QUICK DISCONNECT COUPLERS
BALL VALVES
LIVE SWIVEL
ASSEMBLY FABRICATION
ACCESSORIES
EQUIPMENT AND PARTS
KITS
AIR BRAKE HOSE ASSY
BRASS



## Male O-Ring Boss to Female Pipe Swivel NPSM - 45°

For use up to SAE 100R2 maximum working pressure.

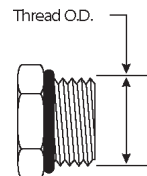
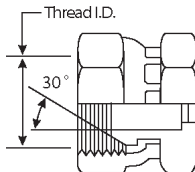
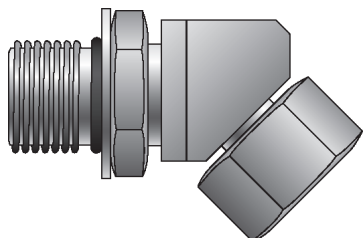

Part No.	Descr.	Prod. No.		
			"	"
G60287-0402	4MB-2FPX45	7259-08835	7/16-20	1/8-27
G60287-0404	4MB-4FPX45	7259-05015	7/16-20	1/4-18
G60287-0406	4MB-6FPX45	7259-07795	7/16-20	3/8-18
G60287-0604	6MB-4FPX45	7259-05825	9/16-18	1/4-18
G60287-0606	6MB-6FPX45	7259-10915	9/16-18	3/8-18
G60287-0608	6MB-8FPX45	7259-06365	9/16-18	1/2-14
G60287-0804	8MB-4FPX45	7259-08845	3/4-16	1/4-18
G60287-0806	8MB-6FPX45	7259-11495	3/4-16	3/8-18
G60287-0808	8MB-8FPX45	7259-10875	3/4-16	1/2-14
G60287-0812	8MB-12FPX45	7259-33295	3/4-16	3/4-14
G60287-1006	10MB-6FPX45	7259-11645	7/8-14	3/8-18
G60287-1008	10MB-8FPX45	7259-10815	7/8-14	1/2-14
G60287-1012	10MB-12FPX45	7259-06575	7/8-14	3/4-14
G60287-1208	12MB-8FPX45	7259-08205	1 1/16-12	1/2-14
G60287-1212	12MB-12FPX45	7259-11315	1 1/16-12	3/4-14
G60287-1216	12MB-16FPX45	7259-07265	1 1/16-12	1-11 1/2
G60287-1612	16MB-12FPX45	7259-07425	1 5/16-12	3/4-14
G60287-1616	16MB-16FPX45	7259-33325	1 5/16-12	1-11 1/2
G60287-2020	20MB-20FPX45	7259-06615	1 5/8-12	1 1/4-11 1/2
G60287-2424	24MB-24FPX45	7259-08415	1 7/8-12	1 1/2-11 1/2

## Male O-Ring Boss to Female Pipe Swivel NPSM - 90°

For use up to SAE 100R2 maximum working pressure.

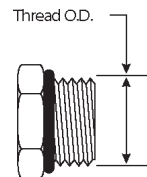
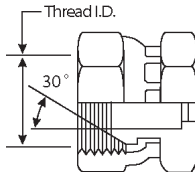
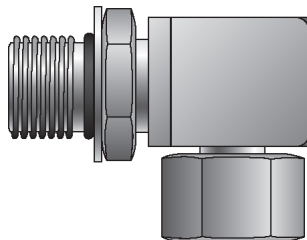

Part No.	Descr.	Prod. No.		
			"	"
G60289-0402	4MB-2FPX90	7259-08215	7/16-20	1/8-27
G60289-0404	4MB-4FPX90	7259-10835	7/16-20	1/4-18
G60289-0406	4MB-6FPX90	7259-06625	7/16-20	3/8-18
G60289-0604	6MB-4FPX90	7259-10405	9/16-18	1/4-18
G60289-0606	6MB-6FPX90	7259-10285	9/16-18	3/8-18
G60289-0608	6MB-8FPX90	7259-05045	9/16-18	1/2-14

- EQUIPMENT
- HOSE/CPLG. SELECTION
- G8K COUPLINGS
- GLOBALSPIRAL COUPLINGS
- STAINLESS STEEL SPIRAL
- MEGACRIMP COUPLINGS
- STAINLESS STEEL BRAID
- POWER CRIMP COUPLINGS
- FIELD ATTACHABLE G1 & G2 COUPLINGS
- FIELD ATTACHABLE C5 COUPLINGS
- C14 COUPLINGS
- GL COUPLINGS
- GLX COUPLINGS
- PCTS THERMOPLASTIC COUPLINGS
- POLARSEAL COUPLINGS (ACA)
- POLARSEAL II COUPLINGS (ACC)
- POLARSEAL II COUPLINGS (ACB)
- POWER STEERING
- ADAPTERS
- QUICK DISCONNECT COUPLERS
- BALL VALVES
- LIVE SWIVEL
- ASSEMBLY FABRICATION
- ACCESSORIES
- EQUIPMENT AND PARTS
- KITS
- AIR BRAKE HOSE ASSY
- BRASS



Male O-Ring Boss to Female Pipe Swivel NPSM - 90° - Continued

EQUIPMENT
HOSE/CPLG. SELECTION
G8K COUPLINGS
GLOBAL SPIRAL COUPLINGS
STAINLESS STEEL SPIRAL
MEGACRIMP COUPLINGS
STAINLESS STEEL BRAID
POWER CRIMP COUPLINGS
FIELD ATTACHABLE G1 & G2 COUPLINGS
FIELD ATTACHABLE C5 COUPLINGS
C14 COUPLINGS
GL COUPLINGS
GLX COUPLINGS
PCTS THERMOPLASTIC COUPLINGS
POLARSEAL COUPLINGS (ACA)
POLARSEAL II COUPLINGS (ACC)
POLARSEAL II COUPLINGS (ACB)
POWER STEERING
ADAPTERS
QUICK DISCONNECT COUPLERS
BALL VALVES
LIVE SWIVEL
ASSEMBLY FABRICATION
ACCESSORIES
EQUIPMENT AND PARTS
KITS
AIR BRAKE HOSE ASSY
BRASS

Part No.	Descr.	Prod. No.		
			"	"
G60289-0804	8MB-4FPX90	7259-06175	3/4-16	1/4-18
G60289-0806	8MB-6FPX90	7259-10295	3/4-16	3/8-18
G60289-0808	8MB-8FPX90	7259-10155	3/4-16	1/2-14
G60289-0812	8MB-12FPX90	7259-11335	3/4-16	3/4-14
G60289-1006	10MB-6FPX90	7259-11215	7/8-14	3/8-18
G60289-1008	10MB-8FPX90	7259-10345	7/8-14	1/2-14
G60289-1012	10MB-12FPX90	7259-11295	7/8-14	3/4-14
G60289-1206	12MB-6FPX90	7259-07895	1 1/16-12	3/8-18
G60289-1208	12MB-8FPX90	7259-00515	1 1/16-12	1/2-14
G60289-1212	12MB-12FPX90	7259-10575	1 1/16-12	3/4-14
G60289-1216	12MB-16FPX90	7259-06935	1 1/16-12	1-11 1/2
G60289-1412	14MB-12FPX90	7259-07175	1 3/16-12	3/4-14
G60289-1612	16MB-12FPX90	7259-05805	1 5/16-12	3/4-14
G60289-1616	16MB-16FPX90	7259-11125	1 5/16-12	1-11 1/2
G60289-1620	16MB-20FPX90	7259-06875	1 5/16-12	1 1/4-11 1/2
G60289-2012	20MB-12FPX90	7259-06945	1 5/8-12	3/4-14
G60289-2016	20MB-16FPX90	7259-06635	1 5/8-12	1-11 1/2
G60289-2020	20MB-20FPX90	7259-05905	1 5/8-12	1 1/4-11 1/2
G60289-2424	24MB-24FPX90	7259-08855	1 7/8-12	1 1/2-11 1/2
G60289-3232	32MB-32FPX90	7259-08045	2 1/2-12	2-11 1/2

Female O-Ring Boss to Male Pipe NPTF

For use up to SAE 100R2 maximum working pressure.

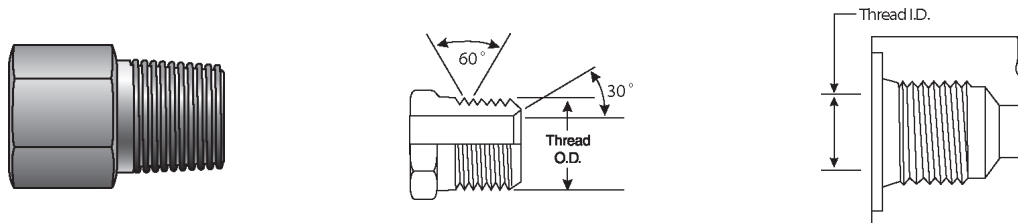



Part No.	Descr.	Prod. No.		
			"	"
G60291-0402	4FB-2MP	7259-33335	7/16-20	1/8-27
G60291-0404	4FB-4MP	7259-06515	7/16-20	1/4-18
G60291-0502	5FB-2MP	7259-33355	1/2-20	1/8-27
G60291-0604	6FB-4MP	7259-33345	9/16-18	1/4-18
G60291-0606	6FB-6MP	7259-00385	9/16-18	3/8-18
G60291-0608	6FB-8MP	7259-00485	9/16-18	1/2-14
G60291-0806	8FB-6MP	7259-33365	3/4-16	3/8-18
G60291-0808	8FB-8MP	7259-08875	3/4-16	1/2-14
G60291-1008	10FB-8MP	7259-33375	7/8-14	1/2-14
G60291-1208	12FB-8MP	7259-06955	1 1/16-12	1/2-14
G60291-1212	12FB-12MP	7259-33385	1 1/16-12	3/4-14
G60291-1612	16FB-12MP	7259-08885	1 5/16-12	3/4-14
G60291-1616	16FB-16MP	7259-33395	1 5/16-12	1-11 1/2

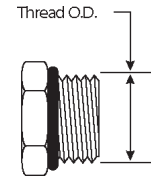
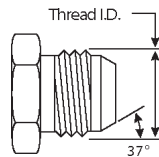
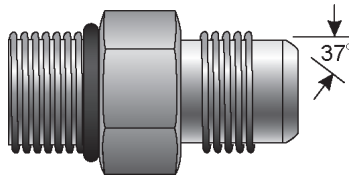

## Male O-Ring Boss to Male JIC 37° Flare

For use up to SAE 100R2 maximum working pressure.



Part No.	Descr.	Prod. No.		
			"	"
G60301-0202	2MB-2MJ	7259-07275	5/16-24	5/16-24
G60301-0204	2MB-4MJ	7259-08895	5/16-24	7/16-20
G60301-0304	3MB-4MJ	7259-06255	3/8-24	7/16-20
G60301-0403	4MB-3MJ	7259-08905	7/16-20	3/8-24
G60301-0404	4MB-4MJ	7259-10025	7/16-20	7/16-20
G60301-0405	4MB-5MJ	7259-05005	7/16-20	1/2-20
G60301-0406	4MB-6MJ	7259-33405	7/16-20	9/16-18
G60301-0408	4MB-8MJ	7259-08915	7/16-20	3/4-16
G60301-0503	5MB-3MJ	7253-86885	1/2-20	3/8-24
G60301-0504	5MB-4MJ	7259-10775	1/2-20	7/16-20
G60301-0505	5MB-5MJ	7259-10855	1/2-20	1/2-20
G60301-0506	5MB-6MJ	7259-33415	1/2-20	9/16-18
G60301-0604	6MB-4MJ	7259-10045	9/16-18	7/16-20
G60301-0605	6MB-5MJ	7259-00455	9/16-18	1/2-20
G60301-0606	6MB-6MJ	7259-04685	9/16-18	9/16-18
G60301-0608	6MB-8MJ	7259-10145	9/16-18	3/4-16
G60301-0610	6MB-10MJ	7259-33425	9/16-18	7/8-14
G60301-0612	6MB-12MJ	7259-07635	9/16-18	1 1/16-12
G60301-0804	8MB-4MJ	7259-00025	3/4-16	7/16-20
G60301-0805	8MB-5MJ	7259-06885	3/4-16	1/2-20
G60301-0806	8MB-6MJ	7259-04775	3/4-16	9/16-18
G60301-0808	8MB-8MJ	7259-10015	3/4-16	3/4-16
G60301-0810	8MB-10MJ	7259-10425	3/4-16	7/8-14
G60301-0812	8MB-12MJ	7259-10305	3/4-16	1 1/16-12
G60301-0816	8MB-16MJ	7259-07285	3/4-16	1 5/16-12
G60301-1004	10MB-4MJ	7259-00105	7/8-14	7/16-20
G60301-1006	10MB-6MJ	7259-10095	7/8-14	9/16-18
G60301-1008	10MB-8MJ	7259-10075	7/8-14	3/4-16
G60301-1010	10MB-10MJ	7259-10065	7/8-14	7/8-14
G60301-1012	10MB-12MJ	7259-00235	7/8-14	1 1/16-12
G60301-1016	10MB-16MJ	7259-00355	7/8-14	1 5/16-12
G60301-1204	12MB-4MJ	7259-07905	1 1/16-12	7/16-20
G60301-1206	12MB-6MJ	7259-00305	1 1/16-12	9/16-18
G60301-1208	12MB-8MJ	7259-10035	1 1/16-12	3/4-16
G60301-1210	12MB-10MJ	7259-10755	1 1/16-12	7/8-14
G60301-1212	12MB-12MJ	7259-10115	1 1/16-12	1 1/16-12
G60301-1214	12MB-14MJ	7259-08225	1 1/16-12	1 3/16-12
G60301-1216	12MB-16MJ	7259-10885	1 1/16-12	1 5/16-12
G60301-1220	12MB-20MJ	7259-06005	1 1/16-12	1 5/8-12
G60301-1410	14MB-10MJ	7259-08425	1 3/16-12	7/8-14
G60301-1412	14MB-12MJ	7259-06185	1 3/16-12	1 1/16-12
G60301-1414	14MB-14MJ	7259-07525	1 3/16-12	1 3/16-12
G60301-1416	14MB-16MJ	7259-08235	1 3/16-12	1 5/16-12
G60301-1608	16MB-8MJ	7259-00125	1 5/16-12	3/4-16
G60301-1610	16MB-10MJ	7259-11385	1 5/16-12	7/8-14
G60301-1612	16MB-12MJ	7259-10135	1 5/16-12	1 1/16-12
G60301-1616	16MB-16MJ	7259-10055	1 5/16-12	1 5/16-12
G60301-1620	16MB-20MJ	7259-05485	1 5/16-12	1 5/8-12

EQUIPMENT
HOSE/CPLG. SELECTION
G8K COUPLINGS
GLOBAL SPIRAL COUPLINGS
STAINLESS STEEL SPIRAL
MEGACRIMP COUPLINGS
STAINLESS STEEL BRAID
POWER CRIMP COUPLINGS
FIELD ATTACHABLE G1 & G2 COUPLINGS
FIELD ATTACHABLE C5 COUPLINGS
C14 COUPLINGS
GL COUPLINGS
GLX COUPLINGS
PCTS THERMOPLASTIC COUPLINGS
POLARSEAL COUPLINGS (ACA)
POLARSEAL II COUPLINGS (ACC)
POLARSEAL II COUPLINGS (ACB)
POWER STEERING
ADAPTERS
QUICK DISCONNECT COUPLERS
BALL VALVES
LIVE SWIVEL
ASSEMBLY FABRICATION
ACCESSORIES
EQUIPMENT AND PARTS
KITS
AIR BRAKE HOSE ASSY
BRASS



EQUIPMENT
HOSE/CPLG. SELECTION
G8K COUPLINGS
GLOBAL SPIRAL COUPLINGS
STAINLESS STEEL SPIRAL
MEGACRIMP COUPLINGS
STAINLESS STEEL BRAID
POWER CRIMP COUPLINGS
FIELD ATTACHABLE G1 & G2 COUPLINGS
FIELD ATTACHABLE C5 COUPLINGS
C14 COUPLINGS
GL COUPLINGS
GLX COUPLINGS
PCTS THERMOPLASTIC COUPLINGS
POLARSEAL COUPLINGS (ACA)
POLARSEAL II COUPLINGS (ACC)
POLARSEAL II COUPLINGS (ACB)
POWER STEERING
ADAPTERS
QUICK DISCONNECT COUPLERS
BALL VALVES
LIVE SWIVEL
ASSEMBLY FABRICATION
ACCESSORIES
EQUIPMENT AND PARTS
KITS
AIR BRAKE HOSE ASSY
BRASS

### Male O-Ring Boss to Male JIC 37° Flare - Continued

Part No.	Descr.	Prod. No.		
			"	"
G60301-2010	20MB-10MJ	7253-86907	1 5/8-12	7/8-14
G60301-2012	20MB-12MJ	7259-11255	1 5/8-12	1 1/16-12
G60301-2016	20MB-16MJ	7259-10245	1 5/8-12	1 5/16-12
G60301-2020	20MB-20MJ	7259-11235	1 5/8-12	1 5/8-12
G60301-2024	20MB-24MJ	7259-06315	1 5/8-12	1 7/8-12
G60301-2416	24MB-16MJ	7259-00365	1 7/8-12	1 5/16-12
G60301-2420	24MB-20MJ	7259-05505	1 7/8-12	1 5/8-12
G60301-2424	24MB-24MJ	7259-05345	1 7/8-12	1 7/8-12
G60301-3224	32MB-24MJ	7259-07645	2 1/2-12	1 7/8-12
G60301-3232	32MB-32MJ	7259-09855	2 1/2-12	2 1/2-12

### Male O-Ring Boss to Male JIC 37° Flare - 45°

For use up to SAE 100R2 maximum working pressure.

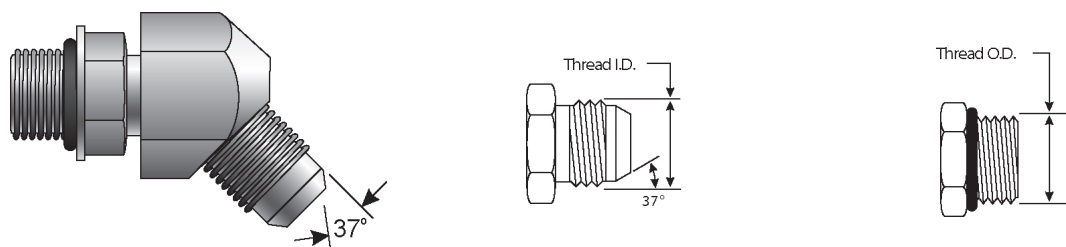



Part No.	Descr.	Prod. No.		
			"	"
G60308-0404	4MB-4MJ45	7259-28565	7/16-20	7/16-20
G60308-0406	4MB-6MJ45	7259-00095	7/16-20	9/16-18
G60308-0505	5MB-5MJ45	7259-28575	1/2-20	1/2-20
G60308-0506	5MB-6MJ45	7259-05405	1/2-20	9/16-18
G60308-0604	6MB-4MJ45	7259-00065	9/16-18	7/16-20
G60308-0606	6MB-6MJ45	7259-28585	9/16-18	9/16-18
G60308-0608	6MB-8MJ45	7259-05335	9/16-18	3/4-16
G60308-0806	8MB-6MJ45	7259-77595	3/4-16	9/16-18
G60308-0808	8MB-8MJ45	7259-28255	3/4-16	3/4-16
G60308-0810	8MB-10MJ45	7259-28415	3/4-16	7/8-14
G60308-0812	8MB-12MJ45	7259-06895	3/4-16	1 1/16-12
G60308-1008	10MB-8MJ45	7259-28425	7/8-14	3/4-16
G60308-1010	10MB-10MJ45	7259-10895	7/8-14	7/8-14
G60308-1012	10MB-12MJ45	7259-05785	7/8-14	1 1/16-12
G60308-1210	12MB-10MJ45	7259-77605	1 1/16-12	7/8-14
G60308-1212	12MB-12MJ45	7259-28595	1 1/16-12	1 1/16-12
G60308-1216	12MB-16MJ45	7259-28435	1 1/16-12	1 5/16-12
G60308-1414	14MB-14MJ45	7259-28605	1 3/16-12	1 3/16-12
G60308-1612	16MB-12MJ45	7259-28445	1 5/16-12	1 1/16-12
G60308-1616	16MB-16MJ45	7259-28615	1 5/16-12	1 5/16-12
G60308-1620	16MB-20MJ45	7259-08065	1 5/16-12	1 5/8-12
G60308-2016	20MB-16MJ45	7259-07295	1 5/8-12	1 5/16-12
G60308-2020	20MB-20MJ45	7259-05955	1 5/8-12	1 5/8-12
G60308-2424	24MB-24MJ45	7259-06975	1 7/8-12	1 7/8-12

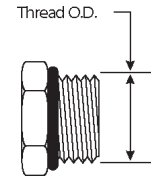
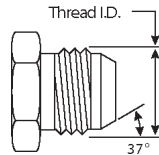
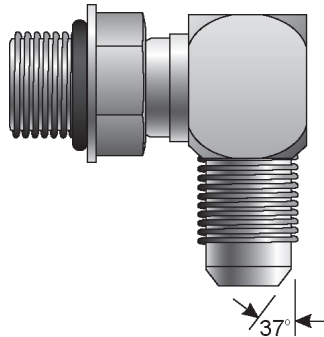

## Male O-Ring Boss to Male JIC 37° Flare - 90°

For use up to SAE 100R2 maximum working pressure.



Part No.	Descr.	Prod. No.		
			"	"
G60312-0202	2MB-2MJ90	7259-08925	5/16-24	5/16-24
G60312-0303	3MB-3MJ90	7259-77615	3/8-24	3/8-24
G60312-0404	4MB-4MJ90	7259-28265	7/16-20	7/16-20
G60312-0405	4MB-5MJ90	7259-77625	7/16-20	1/2-20
G60312-0406	4MB-6MJ90	7259-28455	7/16-20	9/16-18
G60312-0408	4MB-8MJ90	7259-09825	7/16-20	3/4-16
G60312-0504	5MB-4MJ90	7259-05615	1/2-20	7/16-20
G60312-0505	5MB-5MJ90	7259-28625	1/2-20	1/2-20
G60312-0506	5MB-6MJ90	7259-05075	1/2-20	9/16-18
G60312-0508	5MB-8MJ90	7259-06985	1/2-20	3/4-16
G60312-0604	6MB-4MJ90	7259-28465	9/16-18	7/16-20
G60312-0605	6MB-5MJ90	7259-28475	9/16-18	1/2-20
G60312-0606	6MB-6MJ90	7259-28275	9/16-18	9/16-18
G60312-0608	6MB-8MJ90	7259-28485	9/16-18	3/4-16
G60312-0610	6MB-10MJ90	7259-28495	9/16-18	7/8-14
G60312-0612	6MB-12MJ90	7259-07915	9/16-18	1 1/16-12
G60312-0804	8MB-4MJ90	7259-05165	3/4-16	7/16-20
G60312-0805	8MB-5MJ90	7259-08075	3/4-16	1/2-20
G60312-0806	8MB-6MJ90	7259-28505	3/4-16	9/16-18
G60312-0808	8MB-8MJ90	7259-28285	3/4-16	3/4-16
G60312-0810	8MB-10MJ90	7259-28515	3/4-16	7/8-14
G60312-0812	8MB-12MJ90	7259-28525	3/4-16	1 1/16-12
G60312-0816	8MB-16MJ90	7259-08445	3/4-16	1 5/16-12
G60312-1005	10MB-5MJ90	7259-08935	7/8-14	1/2-20
G60312-1006	10MB-6MJ90	7259-00215	7/8-14	9/16-18
G60312-1008	10MB-8MJ90	7259-28295	7/8-14	3/4-16
G60312-1010	10MB-10MJ90	7259-28635	7/8-14	7/8-14
G60312-1012	10MB-12MJ90	7259-28535	7/8-14	1 1/16-12
G60312-1016	10MB-16MJ90	7259-05275	7/8-14	1 5/16-12
G60312-1206	12MB-6MJ90	7259-05065	1 1/16-12	9/16-18
G60312-1208	12MB-8MJ90	7259-00055	1 1/16-12	3/4-16
G60312-1210	12MB-10MJ90	7259-28545	1 1/16-12	7/8-14
G60312-1212	12MB-12MJ90	7259-28645	1 1/16-12	1 1/16-12
G60312-1214	12MB-14MJ90	7259-08945	1 1/16-12	1 3/16-12
G60312-1216	12MB-16MJ90	7259-28555	1 1/16-12	1 5/16-12
G60312-1220	12MB-20MJ90	7259-08435	1 1/16-12	1 5/8-12
G60312-1412	14MB-12MJ90	7259-06435	1 3/16-12	1 1/16-12
G60312-1414	14MB-14MJ90	7259-28655	1 3/16-12	1 3/16-12
G60312-1416	14MB-16MJ90	7259-07305	1 3/16-12	1 5/16-12
G60312-1420	14MB-20MJ90	7259-08955	1 3/16-12	1 5/8-12
G60312-1608	16MB-8MJ90	7259-05885	1 5/16-12	3/4-16
G60312-1610	16MB-10MJ90	7259-08965	1 5/16-12	7/8-14

EQUIPMENT
HOSE/CPLG. SELECTION
G8K COUPLINGS
GLOBALSPIRAL COUPLINGS
STAINLESS STEEL SPIRAL
MEGACRIMP COUPLINGS
STAINLESS STEEL BRAID
POWER CRIMP COUPLINGS
FIELD ATTACHABLE G1 & G2 COUPLINGS
FIELD ATTACHABLE C5 COUPLINGS
C14 COUPLINGS
GL COUPLINGS
GLX COUPLINGS
PCTS THERMOPLASTIC COUPLINGS
POLARSEAL COUPLINGS (ACA)
POLARSEAL II COUPLINGS (ACC)
POLARSEAL II COUPLINGS (ACB)
POWER STEERING
ADAPTERS
QUICK DISCONNECT COUPLERS
BALL VALVES
LIVE SWIVEL
ASSEMBLY FABRICATION
ACCESSORIES
EQUIPMENT AND PARTS
KITS
AIR BRAKE HOSE ASSY
BRASS





EQUIPMENT
HOSE/CPLG. SELECTION
G8K COUPLINGS
GLOBAL SPIRAL COUPLINGS
STAINLESS STEEL SPIRAL
MEGACRIMP COUPLINGS
STAINLESS STEEL BRAID
POWER CRIMP COUPLINGS
FIELD ATTACHABLE G1 & G2 COUPLINGS
FIELD ATTACHABLE C5 COUPLINGS
C14 COUPLINGS
GL COUPLINGS
GLX COUPLINGS
PCTS THERMOPLASTIC COUPLINGS
POLARSEAL COUPLINGS (ACA)
POLARSEAL II COUPLINGS (ACC)
POLARSEAL II COUPLINGS (ACB)
POWER STEERING
ADAPTERS
QUICK DISCONNECT COUPLERS
BALL VALVES
LIVE SWIVEL
ASSEMBLY FABRICATION
ACCESSORIES
EQUIPMENT AND PARTS
KITS
AIR BRAKE HOSE ASSY
BRASS

### Male O-Ring Boss to Male JIC 37° Flare - 90° - Continued

Part No.	Descr.	Prod. No.		
			"	"
G60312-1612	16MB-12MJ90	7259-28315	1 5/16-12	1 1/16-12
G60312-1614	16MB-14MJ90	7259-08975	1 5/16-12	1 3/16-12
G60312-1616	16MB-16MJ90	7259-28325	1 5/16-12	1 5/16-12
G60312-1620	16MB-20MJ90	7259-77655	1 5/16-12	1 5/8-12
G60312-1624	16MB-24MJ90	7259-08255	1 5/16-12	1 7/8-12
G60312-2010	20MB-10MJ90	7259-08265	1 5/8-12	7/8-14
G60312-2012	20MB-12MJ90	7259-05995	1 5/8-12	1 1/16-12
G60312-2016	20MB-16MJ90	7259-05055	1 5/8-12	1 5/16-12
G60312-2020	20MB-20MJ90	7259-77665	1 5/8-12	1 5/8-12
G60312-2024	20MB-24MJ90	7259-06015	1 5/8-12	1 7/8-12
G60312-2420	24MB-20MJ90	7259-06525	1 7/8-12	1 5/8-12
G60312-2424	24MB-24MJ90	7259-77675	1 7/8-12	1 7/8-12
G60312-3232	32MB-32MJ90	7259-07135	2 1/2-12	2 1/2-12

### Male O-Ring Boss to Female JIC 37° Flare Swivel

For use up to SAE 100R2 maximum working pressure.

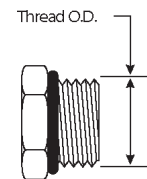
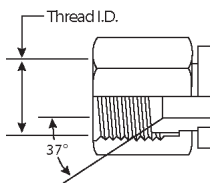
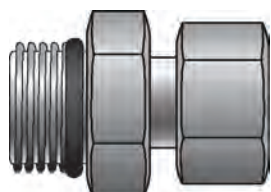

Part No.	Descr.	Prod. No.		
			"	"
G60320-0606	6MB-6FJX	7259-42155	9/16-18	9/16-18
G60320-0808	8MB-8FJX	7259-42185	3/4-16	3/4-16

### Male JIC 37° Flare on Run to Male O-Ring Boss - Tee

For use up to SAE 100R2 maximum working pressure.

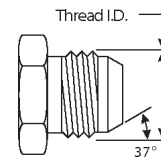
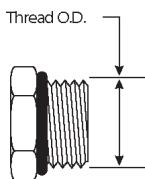
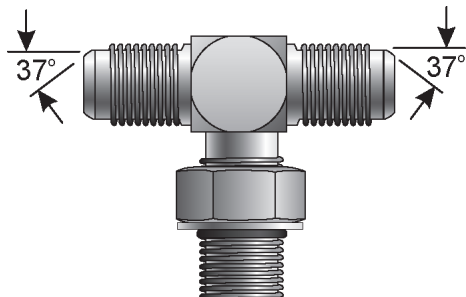

Part No.	Descr.	Prod. No.			
			"	"	"
G60350-0404	4MJ-4MJ-4MB	7259-33615	7/16-20	7/16-20	7/16-20
G60350-0505	5MJ-5MJ-5MB	7259-33625	1/2-20	1/2-20	1/2-20
G60350-0606	6MJ-6MJ-6MB	7259-33635	9/16-18	9/16-18	9/16-18





Male JIC 37° Flare on Run to Male O-Ring Boss - Tee - Continued

Part No.	Descr.	Prod. No.			
			"	"	"
G60350-0608	6MJ-6MJ-8MB	7259-06165	9/16-18	9/16-18	3/4-16
G60350-0808	8MJ-8MJ-8MB	7259-33645	3/4-16	3/4-16	3/4-16
G60350-0810	8MJ-8MJ-10MB	7259-07655	3/4-16	3/4-16	7/8-14
G60350-1010	10MJ-10MJ-10MB	7259-33655	7/8-14	7/8-14	7/8-14
G60350-1210	12MJ-12MJ-10MB	7259-08985	1 1/16-12	1 1/16-12	7/8-14
G60350-1212	12MJ-12MJ-12MB	7259-33665	1 1/16-12	1 1/16-12	1 1/16-12
G60350-1414	14MJ-14MJ-14MB	7259-08995	1 3/16-12	1 3/16-12	1 3/16-12
G60350-1616	16MJ-16MJ-16MB	7259-33675	1 5/16-12	1 5/16-12	1 5/16-12
G60350-2020	20MJ-20MJ-20MB	7259-09005	1 5/8-12	1 5/8-12	1 5/8-12
G60350-2424	24MJ-24MJ-24MB	7259-09015	1 7/8-12	1 7/8-12	1 7/8-12

Male O-Ring Boss to Male JIC 37° Flare to Male JIC 37° Flare - Tee

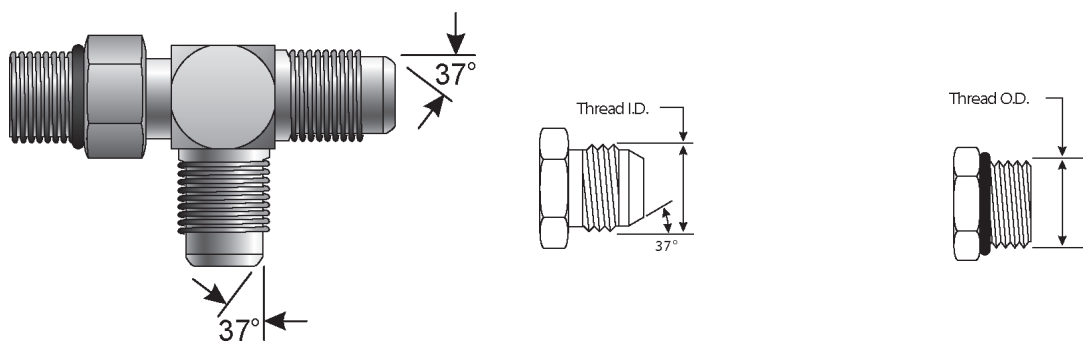
For use up to SAE 100R2 maximum working pressure.



Part No.	Descr.	Prod. No.			
			"	"	"
G60352-0404	4MB-4MJ-4MJ	7259-33685	7/16-20	7/16-20	7/16-20
G60352-0505	5MB-5MJ-5MJ	7259-33695	1/2-20	1/2-20	1/2-20
G60352-0606	6MB-6MJ-6MJ	7259-33705	9/16-18	9/16-18	9/16-18
G60352-0608	6MB-8MJ-6MJ	7259-00185	9/16-18	3/4-16	9/16-18
G60352-0808	8MB-8MJ-8MJ	7259-33715	3/4-16	3/4-16	3/4-16
G60352-1010	10MB-10MJ-10MJ	7259-33725	7/8-14	7/8-14	7/8-14
G60352-1212	12MB-12MJ-12MJ	7259-33735	1 1/16-12	1 1/16-12	1 1/16-12
G60352-1216	12MB-12MJ-16MJ	7259-09025	1 1/16-12	1 1/16-12	1 5/16-12
G60352-1414	14MB-14MJ-14MJ	7259-09035	1 3/16-12	1 3/16-12	1 3/16-12
G60352-1616	16MB-16MJ-16MJ	7259-33745	1 5/16-12	1 5/16-12	1 5/16-12
G60352-2020	20MB-20MJ-20MJ	7259-07535	1 5/8-12	1 5/8-12	1 5/8-12
G60352-2424	24MB-24MJ-24MJ	7259-09045	1 7/8-12	1 7/8-12	1 7/8-12

- EQUIPMENT
- HOSE/CPLG. SELECTION
- G8K COUPLINGS
- GLOBAL SPIRAL COUPLINGS
- STAINLESS STEEL SPIRAL
- MEGACRIMP COUPLINGS
- STAINLESS STEEL BRAID
- POWER CRIMP COUPLINGS
- FIELD ATTACHABLE G1 & G2 COUPLINGS
- FIELD ATTACHABLE C5 COUPLINGS
- C14 COUPLINGS
- GL COUPLINGS
- GLX COUPLINGS
- PCTS THERMOPLASTIC COUPLINGS
- POLARSEAL COUPLINGS (ACA)
- POLARSEAL II COUPLINGS (ACC)
- POLARSEAL II COUPLINGS (ACB)
- POWER STEERING
- ADAPTERS
- QUICK DISCONNECT COUPLERS
- BALL VALVES
- LIVE SWIVEL
- ASSEMBLY FABRICATION
- ACCESSORIES
- EQUIPMENT AND PARTS
- KITS
- AIR BRAKE HOSE ASSY
- BRASS



## Female JIC 37° Flare Cap

For use up to SAE 100R2 maximum working pressure.

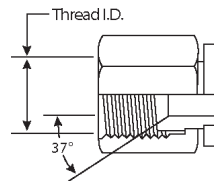
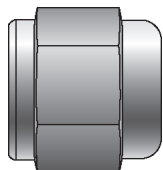

Part No.	Descr.	Prod. No.	
			"
G60401-0002	2FJ-CAP	7259-09865	5/16-24
G60401-0003	3FJ-CAP	7259-07435	3/8-24
G60401-0004	4FJ-CAP	7259-24305	7/16-20
G60401-0005	5FJ-CAP	7259-24315	1/2-20
G60401-0006	6FJ-CAP	7259-24325	9/16-18
G60401-0008	8FJ-CAP	7259-24335	3/4-16
G60401-0010	10FJ-CAP	7259-24345	7/8-14
G60401-0012	12FJ-CAP	7259-24355	1 1/16-12
G60401-0014	14FJ-CAP	7259-00445	1 3/16-12
G60401-0016	16FJ-CAP	7259-24365	1 5/16-12
G60401-0020	20FJ-CAP	7253-24375	1 5/8-12
G60401-0024	24FJ-CAP	7259-24385	1 7/8-12
G60401-0032	32FJ-CAP	7259-24405	2 1/2-12

## Male JIC 37° Flare Plug

For use up to SAE 100R2 maximum working pressure.

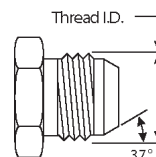
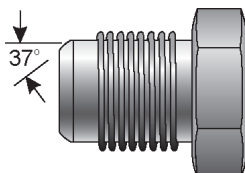

Part No.	Descr.	Prod. No.	
			"
G60402-0003	3MJ-PLUG	7259-09775	3/8-24
G60402-0004	4MJ-PLUG	7259-22885	7/16-20
G60402-0005	5MJ-PLUG	7259-22895	1/2-20
G60402-0006	6MJ-PLUG	7259-22905	9/16-18
G60402-0008	8MJ-PLUG	7259-22915	3/4-16
G60402-0010	10MJ-PLUG	7259-22925	7/8-14
G60402-0012	12MJ-PLUG	7259-22935	1 1/16-12
G60402-0014	14MJ-PLUG	7259-22945	1 3/16-12
G60402-0016	16MJ-PLUG	7259-22955	1 5/16-12
G60402-0020	20MJ-PLUG	7259-22965	1 5/8-12
G60402-0024	24MJ-PLUG	7259-33755	1 7/8-12
G60402-0032	32MJ-PLUG	7259-33765	2 1/2-12



EQUIPMENT
HOSE/CPLG. SELECTION
G8K COUPLINGS
GLOBAL SPIRAL COUPLINGS
STAINLESS STEEL SPIRAL
MEGACRIMP COUPLINGS
STAINLESS STEEL BRAID
POWER CRIMP COUPLINGS
FIELD ATTACHABLE G1 & G2 COUPLINGS
FIELD ATTACHABLE C5 COUPLINGS
C14 COUPLINGS
GL COUPLINGS
GLX COUPLINGS
PCTS THERMOPLASTIC COUPLINGS
POLARSEAL COUPLINGS (ACA)
POLARSEAL II COUPLINGS (ACC)
POLARSEAL II COUPLINGS (ACB)
POWER STEERING
ADAPTERS
QUICK DISCONNECT COUPLERS
BALL VALVES
LIVE SWIVEL
ASSEMBLY FABRICATION
ACCESSORIES
EQUIPMENT AND PARTS
KITS
AIR BRAKE HOSE ASSY
BRASS

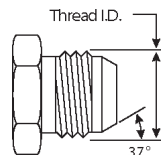
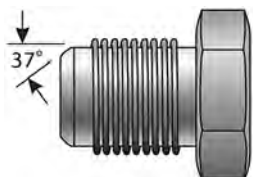

### Male JIC 37° Flare to Female Braze - On

For use up to SAE 100R2 maximum working pressure.





Part No.	Descr.	Prod. No.		
				
G60405-2020	20MJ-20FBO	7253-28735	1 1/4	1 5/8-12

### Male JIC 37° Flare to Male JIC 37° Flare

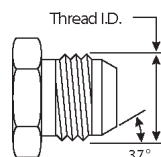
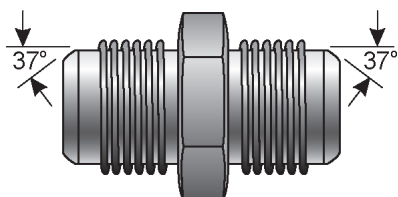
For use up to SAE 100R2 maximum working pressure.



Part No.	Descr.	Prod. No.		
				
G60410-0202	2MJ-2MJ	7259-77775	5/16-24	5/16-24
G60410-0302	3MJ-2MJ	7259-09065	3/8-24	5/16-24
G60410-0303	3MJ-3MJ	7259-77785	3/8-24	3/8-24
G60410-0403	4MJ-3MJ	7259-09075	7/16-20	3/8-24
G60410-0404	4MJ-4MJ	7259-10125	7/16-20	7/16-20
G60410-0504	5MJ-4MJ	7259-77795	1/2-20	7/16-20
G60410-0505	5MJ-5MJ	7259-10735	1/2-20	1/2-20
G60410-0604	6MJ-4MJ	7259-00285	9/16-18	7/16-20
G60410-0605	6MJ-5MJ	7259-77805	9/16-18	1/2-20
G60410-0606	6MJ-6MJ	7259-06265	9/16-18	9/16-18
G60410-0804	8MJ-4MJ	7259-06505	3/4-16	7/16-20
G60410-0805	8MJ-5MJ	7259-09085	3/4-16	1/2-20
G60410-0806	8MJ-6MJ	7259-00075	3/4-16	9/16-18
G60410-0808	8MJ-8MJ	7259-06275	3/4-16	3/4-16
G60410-1004	10MJ-4MJ	7259-07195	7/8-14	7/16-20
G60410-1006	10MJ-6MJ	7259-07805	7/8-14	9/16-18
G60410-1008	10MJ-8MJ	7259-00375	7/8-14	3/4-16
G60410-1010	10MJ-10MJ	7259-10225	7/8-14	7/8-14
G60410-1204	12MJ-4MJ	7259-09095	1 1/16-12	7/16-20
G60410-1206	12MJ-6MJ	7259-08455	1 1/16-12	9/16-18
G60410-1208	12MJ-8MJ	7259-77815	1 1/16-12	3/4-16
G60410-1210	12MJ-10MJ	7259-00565	1 1/16-12	7/8-14
G60410-1212	12MJ-12MJ	7259-10235	1 1/16-12	1 1/16-12
G60410-1412	14MJ-12MJ	7259-09105	1 3/16-12	1 1/16-12
G60410-1414	14MJ-14MJ	7259-77825	1 3/16-12	1 3/16-12
G60410-1608	16MJ-8MJ	7259-07205	1 5/16-12	3/4-16
G60410-1610	16MJ-10MJ	7259-07505	1 5/16-12	7/8-14
G60410-1612	16MJ-12MJ	7259-77835	1 5/16-12	1 1/16-12
G60410-1616	16MJ-16MJ	7259-10655	1 5/16-12	1 5/16-12

EQUIPMENT
HOSE/CPLG. SELECTION
G8K COUPLINGS
GLOBALSPIRAL COUPLINGS
STAINLESS STEEL SPIRAL
MEGACRIMP COUPLINGS
STAINLESS STEEL BRAID
POWER CRIMP COUPLINGS
FIELD ATTACHABLE G1 & G2 COUPLINGS
FIELD ATTACHABLE C5 COUPLINGS
C14 COUPLINGS
GL COUPLINGS
GLX COUPLINGS
PCTS THERMOPLASTIC COUPLINGS
POLARSEAL COUPLINGS (ACA)
POLARSEAL II COUPLINGS (ACC)
POLARSEAL II COUPLINGS (ACB)
POWER STEERING
ADAPTERS
QUICK DISCONNECT COUPLERS
BALL VALVES
LIVE SWIVEL
ASSEMBLY FABRICATION
ACCESSORIES
EQUIPMENT AND PARTS
KITS
AIR BRAKE HOSE ASSY
BRASS



EQUIPMENT
HOSE/CPLG. SELECTION
G8K COUPLINGS
GLOBAL SPIRAL COUPLINGS
STAINLESS STEEL SPIRAL
MEGACRIMP COUPLINGS
STAINLESS STEEL BRAID
POWER CRIMP COUPLINGS
FIELD ATTACHABLE G1 & G2 COUPLINGS
FIELD ATTACHABLE C5 COUPLINGS
C14 COUPLINGS
GL COUPLINGS
GLX COUPLINGS
PCTS THERMOPLASTIC COUPLINGS
POLARSEAL COUPLINGS (ACA)
POLARSEAL II COUPLINGS (ACC)
POLARSEAL II COUPLINGS (ACB)
POWER STEERING
ADAPTERS
QUICK DISCONNECT COUPLERS
BALL VALVES
LIVE SWIVEL
ASSEMBLY FABRICATION
ACCESSORIES
EQUIPMENT AND PARTS
KITS
AIR BRAKE HOSE ASSY
BRASS

### Male JIC 37° Flare to Male JIC 37° Flare - Continued

Part No.	Descr.	Prod. No.		
			"	"
G60410-2012	20MJ-12MJ	7259-09115	1 5/8-12	1 1/16-12
G60410-2016	20MJ-16MJ	7259-06555	1 5/8-12	1 5/16-12
G60410-2020	20MJ-20MJ	7259-11145	1 5/8-12	1 5/8-12
G60410-2412	24MJ-12MJ	7259-09125	1 7/8-12	1 1/16-12
G60410-2420	24MJ-20MJ	7259-09135	1 7/8-12	1 5/8-12
G60410-2424	24MJ-24MJ	7259-33845	1 7/8-12	1 7/8-12
G60410-3232	32MJ-32MJ	7259-33855	2 1/2-12	2 1/2-12

### Male JIC 37° Flare to Male JIC 37° Flare - 90°

For use up to SAE 100R2 maximum working pressure.

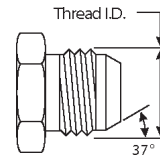
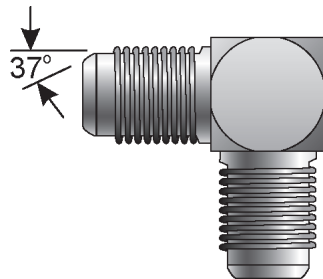



Part No.	Descr.	Prod. No.		
			"	"
G60417-0202	2MJ-2MJ90	7259-09145	5/16-24	5/16-24
G60417-0404	4MJ-4MJ90	7259-77845	7/16-20	7/16-20
G60417-0505	5MJ-5MJ90	7259-05865	1/2-20	1/2-20
G60417-0604	6MJ-4MJ90	7259-07925	9/16-18	7/16-20
G60417-0606	6MJ-6MJ90	7259-77855	9/16-18	9/16-18
G60417-0806	8MJ-6MJ90	7259-06745	3/4-16	9/16-18
G60417-0808	8MJ-8MJ90	7259-77865	3/4-16	3/4-16
G60417-1010	10MJ-10MJ90	7259-77875	7/8-14	7/8-14
G60417-1212	12MJ-12MJ90	7259-77885	1 1/16-12	1 1/16-12
G60417-1414	14MJ-14MJ90	7259-08275	1 3/16-12	1 3/16-12
G60417-1612	16MJ-12MJ90	7259-09155	1 5/16-12	1 1/16-12
G60417-1616	16MJ-16MJ90	7259-77895	1 5/16-12	1 5/16-12
G60417-2020	20MJ-20MJ90	7259-07095	1 5/8-12	1 5/8-12
G60417-2424	24MJ-24MJ90	7259-07105	1 7/8-12	1 7/8-12
G60417-3232	32MJ-32MJ90	7259-08465	2 1/2-12	2 1/2-12

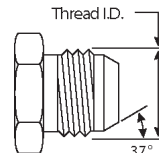
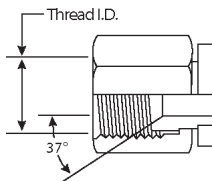
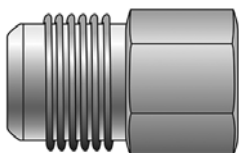

## Male JIC 37° Flare to Female JIC 37° Flare

For use up to SAE 100R2 maximum working pressure.



Part No.	Descr.	Prod. No.		
			"	"
G60420-0406	4MJ-6FJ	7259-33865	7/16-20	9/16-18
G60420-0504	5MJ-4FJ	7259-07445	1/2-20	7/16-20
G60420-0506	5MJ-6FJ	7259-09175	1/2-20	9/16-18
G60420-0604	6MJ-4FJ	7259-00015	9/16-18	7/16-20
G60420-0606	6MJ-6FJ	7259-09195	9/16-18	9/16-18
G60420-0608	6MJ-8FJ	7259-33875	9/16-18	3/4-16
G60420-0610	6MJ-10FJ	7259-33885	9/16-18	7/8-14
G60420-0804	8MJ-4FJ	7259-00935	3/4-16	7/16-20
G60420-0808	8MJ-8FJ	7259-06135	3/4-16	3/4-16
G60420-0810	8MJ-10FJ	7253-33895	3/4-16	7/8-14
G60420-0812	8MJ-12FJ	7259-33905	3/4-16	1 1/16-12
G60420-1004	10MJ-4FJ	7259-05915	7/8-14	7/16-20
G60420-1006	10MJ-6FJ	7259-05375	7/8-14	9/16-18
G60420-1008	10MJ-8FJ	7259-00705	7/8-14	3/4-16
G60420-1012	10MJ-12FJ	7259-33915	7/8-14	1 1/16-12
G60420-1016	10MJ-16FJ	7259-33925	7/8-14	1 5/16-12
G60420-1204	12MJ-4FJ	7259-05235	1 1/16-12	7/16-20
G60420-1206	12MJ-6FJ	7259-00145	1 1/16-12	9/16-18
G60420-1208	12MJ-8FJ	7259-00115	1 1/16-12	3/4-16
G60420-1212	12MJ-12FJ	7259-09205	1 1/16-12	1 1/16-12
G60420-1216	12MJ-16FJ	7253-33935	1 1/16-12	1 5/16-12
G60420-1220	12MJ-20FJ	7253-33945	1 1/16-12	1 5/8-12
G60420-1616	16MJ-16FJ	7259-09215	1 5/16-12	1 5/16-12
G60420-1620	16MJ-20FJ	7259-33955	1 5/16-12	1 5/8-12
G60420-2016	20MJ-16FJ	7259-05085	1 5/8-12	1 5/16-12

## Male JIC 37° Flare to Female JIC 37° Flare Swivel - 90°

For use up to SAE 100R2 maximum working pressure.

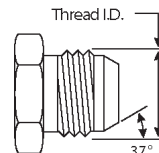
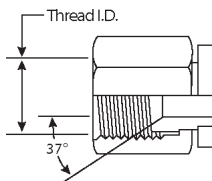
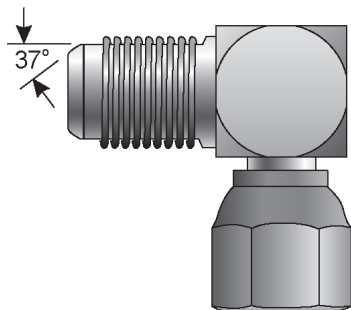

Part No.	Descr.	Prod. No.		
			"	"
G60422-0404	4MJ-4FJX90	7259-23285	7/16-20	7/16-20

- EQUIPMENT
- HOSE/CPLG. SELECTION
- G8K COUPLINGS
- GLOBALSPIRAL COUPLINGS
- STAINLESS STEEL SPIRAL
- MEGACRIMP COUPLINGS
- STAINLESS STEEL BRAID
- POWER CRIMP COUPLINGS
- FIELD ATTACHABLE G1 & G2 COUPLINGS
- FIELD ATTACHABLE C5 COUPLINGS
- C14 COUPLINGS
- GL COUPLINGS
- GLX COUPLINGS
- PCTS THERMOPLASTIC COUPLINGS
- POLARSEAL COUPLINGS (ACA)
- POLARSEAL II COUPLINGS (ACC)
- POLARSEAL II COUPLINGS (ACB)
- POWER STEERING
- ADAPTERS
- QUICK DISCONNECT COUPLERS
- BALL VALVES
- LIVE SWIVEL
- ASSEMBLY FABRICATION
- ACCESSORIES
- EQUIPMENT AND PARTS
- KITS
- AIR BRAKE HOSE ASSY
- BRASS



EQUIPMENT
HOSE/CPLG. SELECTION
G8K COUPLINGS
GLOBAL SPIRAL COUPLINGS
STAINLESS STEEL SPIRAL
MEGACRIMP COUPLINGS
STAINLESS STEEL BRAID
POWER CRIMP COUPLINGS
FIELD ATTACHABLE G1 & G2 COUPLINGS
FIELD ATTACHABLE C5 COUPLINGS
C14 COUPLINGS
GL COUPLINGS
GLX COUPLINGS
PCTS THERMOPLASTIC COUPLINGS
POLARSEAL COUPLINGS (ACA)
POLARSEAL II COUPLINGS (ACC)
POLARSEAL II COUPLINGS (ACB)
POWER STEERING
ADAPTERS
QUICK DISCONNECT COUPLERS
BALL VALVES
LIVE SWIVEL
ASSEMBLY FABRICATION
ACCESSORIES
EQUIPMENT AND PARTS
KITS
AIR BRAKE HOSE ASSY
BRASS

### Male JIC 37° Flare to Female JIC 37° Flare Swivel - 90° - Continued

Part No.	Descr.	Prod. No.		
			"	"
G60422-0505	5MJ-5FJX90	7259-24025	1/2-20	1/2-20
G60422-0604	6MJ-4FJX90	7259-06905	9/16-18	7/16-20
G60422-0606	6MJ-6FJX90	7259-23295	9/16-18	9/16-18
G60422-0806	8MJ-6FJX90	7259-06205	3/4-16	9/16-18
G60422-0808	8MJ-8FJX90	7259-23305	3/4-16	3/4-16
G60422-0810	8MJ-10FJX90	7259-06385	3/4-16	7/8-14
G60422-1010	10MJ-10FJX90	7259-23315	7/8-14	7/8-14
G60422-1212	12MJ-12FJX90	7259-23325	1 1/16-12	1 1/16-12
G60422-1414	14MJ-14FJX90	7259-06215	1 3/16-12	1 3/16-12
G60422-1616	16MJ-16FJX90	7259-23335	1 5/16-12	1 5/16-12
G60422-2020	20MJ-20FJX90	7259-24075	1 5/8-12	1 5/8-12
G60422-2424	24MJ-24FJX90	7259-24085	1 7/8-12	1 7/8-12
G60422-3232	32MJ-32FJX90	7259-24095	2 1/2-12	2 1/2-12

### Male JIC 37° Flare to Female JIC 37° Flare Swivel - 45°

For use up to SAE 100R2 maximum working pressure.

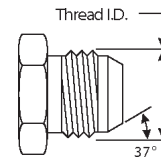
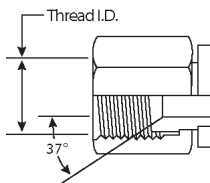
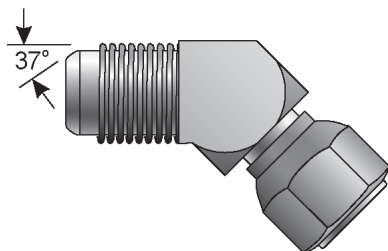

Part No.	Descr.	Prod. No.		
			"	"
G60424-0404	4MJ-4FJX45	7259-23215	7/16-20	7/16-20
G60424-0505	5MJ-5FJX45	7259-33965	1/2-20	1/2-20
G60424-0606	6MJ-6FJX45	7259-23225	9/16-18	9/16-18
G60424-0808	8MJ-8FJX45	7259-23235	3/4-16	3/4-16
G60424-1010	10MJ-10FJX45	7259-23245	7/8-14	7/8-14
G60424-1212	12MJ-12FJX45	7259-23255	1 1/16-12	1 1/16-12
G60424-1414	14MJ-14FJX45	7259-06995	1 3/16-12	1 3/16-12
G60424-1616	16MJ-16FJX45	7259-23265	1 5/16-12	1 5/16-12
G60424-2020	20MJ-20FJX45	7259-23275	1 5/8-12	1 5/8-12
G60424-2424	24MJ-24FJX45	7259-05455	1 7/8-12	1 7/8-12
G60424-3232	32MJ-32FJX45	7259-07935	2 1/2-12	2 1/2-12





### Male JIC 37° Flare to Male JIC 37° Flare Bulkhead

For use up to SAE 100R2 maximum working pressure.

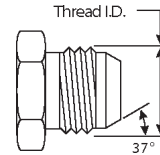
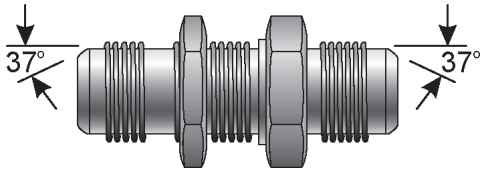

Part No.	Descr.	Prod. No.		
			"	"
G60445-0303	3MJ-3BKHD	7259-09295	3/8-24	3/8-24
G60445-0404	4MJ-4BKHD	7259-24505	7/16-20	7/16-20
G60445-0505	5MJ-5BKHD	7259-24515	1/2-20	1/2-20
G60445-0606	6MJ-6BKHD	7259-24525	9/16-18	9/16-18
G60445-0808	8MJ-8BKHD	7259-24535	3/4-16	3/4-16
G60445-1010	10MJ-10BKHD	7259-24545	7/8-14	7/8-14
G60445-1212	12MJ-12BKHD	7259-24555	1 1/16-12	1 1/16-12
G60445-1414	14MJ-14BKHD	7259-08495	1 3/16-12	1 3/16-12
G60445-1616	16MJ-16BKHD	7259-24565	1 5/16-12	1 5/16-12
G60445-2020	20MJ-20BKHD	7259-34155	1 5/8-12	1 5/8-12
G60445-2424	24MJ-24BKHD	7259-34165	1 7/8-12	1 7/8-12

### Male JIC 37° Flare to Male JIC 37° Flare Bulkhead - 45°

For use up to SAE 100R2 maximum working pressure.

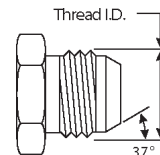
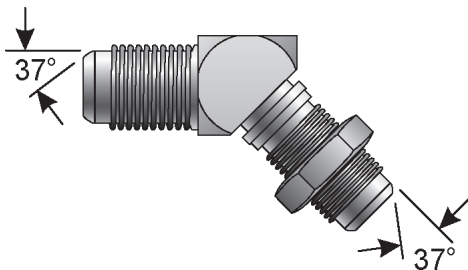

Part No.	Descr.	Prod. No.		
			"	"
G60446-0404	4MJ-4BKHD45	7259-34175	7/16-20	7/16-20
G60446-0505	5MJ-5BKHD45	7259-34185	1/2-20	1/2-20
G60446-0606	6MJ-6BKHD45	7259-34195	9/16-18	9/16-18
G60446-0808	8MJ-8BKHD45	7259-34205	3/4-16	3/4-16
G60446-1010	10MJ-10BKHD45	7259-34215	7/8-14	7/8-14
G60446-1212	12MJ-12BKHD45	7259-34225	1 1/16-12	1 1/16-12
G60446-1616	16MJ-16BKHD45	7259-34235	1 5/16-12	1 5/16-12

- EQUIPMENT
- HOSE/CPLG. SELECTION
- G8K COUPLINGS
- GLOBALSPIRAL COUPLINGS
- STAINLESS STEEL SPIRAL
- MEGACRIMP COUPLINGS
- STAINLESS STEEL BRAID
- POWER CRIMP COUPLINGS
- FIELD ATTACHABLE G1 & G2 COUPLINGS
- FIELD ATTACHABLE C5 COUPLINGS
- C14 COUPLINGS
- GL COUPLINGS
- GLX COUPLINGS
- PCTS THERMOPLASTIC COUPLINGS
- POLARSEAL COUPLINGS (ACA)
- POLARSEAL II COUPLINGS (ACC)
- POLARSEAL II COUPLINGS (ACB)
- POWER STEERING
- ADAPTERS
- QUICK DISCONNECT COUPLERS
- BALL VALVES
- LIVE SWIVEL
- ASSEMBLY FABRICATION
- ACCESSORIES
- EQUIPMENT AND PARTS
- KITS
- AIR BRAKE HOSE ASSY
- BRASS



EQUIPMENT
HOSE/CPLG. SELECTION
G8K COUPLINGS
GLOBAL SPIRAL COUPLINGS
STAINLESS STEEL SPIRAL
MEGACRIMP COUPLINGS
STAINLESS STEEL BRAID
POWER CRIMP COUPLINGS
FIELD ATTACHABLE G1 & G2 COUPLINGS
FIELD ATTACHABLE C5 COUPLINGS
C14 COUPLINGS
GL COUPLINGS
GLX COUPLINGS
PCTS THERMOPLASTIC COUPLINGS
POLARSEAL COUPLINGS (ACA)
POLARSEAL II COUPLINGS (ACC)
POLARSEAL II COUPLINGS (ACB)
POWER STEERING
ADAPTERS
QUICK DISCONNECT COUPLERS
BALL VALVES
LIVE SWIVEL
ASSEMBLY FABRICATION
ACCESSORIES
EQUIPMENT AND PARTS
KITS
AIR BRAKE HOSE ASSY
BRASS

### Male JIC 37° Flare to Male JIC 37° Flare Bulkhead - 90°

For use up to SAE 100R2 maximum working pressure.

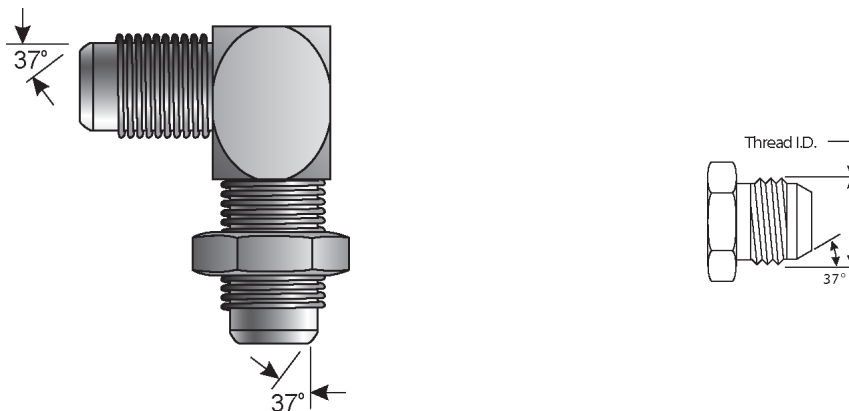

Part No.	Descr.	Prod. No.		
			"	"
G60447-0404	4MJ-4BKHD90	7259-34255	7/16-20	7/16-20
G60447-0505	5MJ-5BKHD90	7259-34265	1/2-20	1/2-20
G60447-0606	6MJ-6BKHD90	7259-34275	9/16-18	9/16-18
G60447-0808	8MJ-8BKHD90	7259-34285	3/4-16	3/4-16
G60447-1010	10MJ-10BKHD90	7259-34295	7/8-14	7/8-14
G60447-1212	12MJ-12BKHD90	7259-34305	1 1/16-12	1 1/16-12
G60447-1414	14MJ-14BKHD90	7259-09315	1 3/16-12	1 3/16-12
G60447-1616	16MJ-16BKHD90	7259-34315	1 5/16-12	1 5/16-12
G60447-2020	20MJ-20BKHD90	7259-34325	1 5/8-12	1 5/8-12
G60447-2424	24MJ-24BKHD90	7259-09325	1 7/8-12	1 7/8-12

### Male JIC 37° Flare Tee

For use up to SAE 100R2 maximum working pressure.

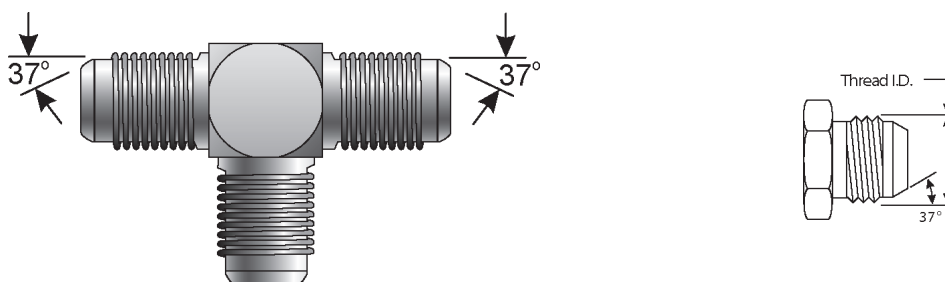

Part No.	Descr.	Prod. No.			
			"	"	"
G60469-0202	2MJ-2MJ-2MJ	7259-77905	5/16-24	5/16-24	5/16-24
G60469-0303	3MJ-3MJ-3MJ	7259-08095	3/8-24	3/8-24	3/8-24
G60469-0404	4MJ-4MJ-4MJ	7259-23345	7/16-20	7/16-20	7/16-20
G60469-0505	5MJ-5MJ-5MJ	7259-34335	1/2-20	1/2-20	1/2-20
G60469-0606	6MJ-6MJ-6MJ	7259-23355	9/16-18	9/16-18	9/16-18
G60469-0608	6MJ-6MJ-8MJ	7253-34345	9/16-18	9/16-18	3/4-16
G60469-0808	8MJ-8MJ-8MJ	7259-23365	3/4-16	3/4-16	3/4-16
G60469-1010	10MJ-10MJ-10MJ	7259-23375	7/8-14	7/8-14	7/8-14
G60469-1212	12MJ-12MJ-12MJ	7259-23385	1 1/16-12	1 1/16-12	1 1/16-12





Male JIC 37° Flare Tee - Continued

Part No.	Descr.	Prod. No.			
			"	"	"
G60469-1414	14MJ-14MJ-14MJ	7259-09335	1 3/16-12	1 3/16-12	1 3/16-12
G60469-1612	16MJ-16MJ-12MJ	7259-34365	1 5/16-12	1 5/16-12	1 1/16-12
G60469-1616	16MJ-16MJ-16MJ	7259-23395	1 5/16-12	1 5/16-12	1 5/16-12
G60469-2020	20MJ-20MJ-20MJ	7259-23405	1 5/8-12	1 5/8-12	1 5/8-12
G60469-2424	24MJ-24MJ-24MJ	7259-07555	1 7/8-12	1 7/8-12	1 7/8-12
G60469-3232	32MJ-32MJ-32MJ	7259-07455	2 1/2-12	2 1/2-12	2 1/2-12

Male JIC 37° Flare on Run to Female JIC 37° Flare Swivel - Tee

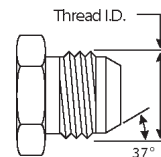
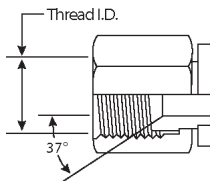
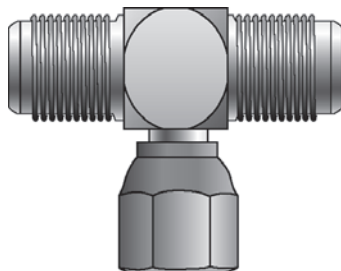
For use up to SAE 100R2 maximum working pressure.



Part No.	Descr.	Prod. No.			
			"	"	"
G60470-0404	4MJ-4MJ-4FJX	7259-24805	7/16-20	7/16-20	7/16-20
G60470-0505	5MJ-5MJ-5FJX	7259-06535	1/2-20	1/2-20	1/2-20
G60470-0606	6MJ-6MJ-6FJX	7259-24815	9/16-18	9/16-18	9/16-18
G60470-0808	8MJ-8MJ-8FJX	7259-24825	3/4-16	3/4-16	3/4-16
G60470-1010	10MJ-10MJ-10FJX	7259-34405	7/8-14	7/8-14	7/8-14
G60470-1212	12MJ-12MJ-12FJX	7259-24835	1 1/16-12	1 1/16-12	1 1/16-12
G60470-1414	14MJ-14MJ-14FJX	7259-07945	1 3/16-12	1 3/16-12	1 3/16-12
G60470-1616	16MJ-16MJ-16FJX	7259-24845	1 5/16-12	1 5/16-12	1 5/16-12
G60470-2020	20MJ-20MJ-20FJX	7259-34415	1 5/8-12	1 5/8-12	1 5/8-12
G60470-2424	24MJ-24MJ-24FJX	7259-08505	1 7/8-12	1 7/8-12	1 7/8-12
G60470-3232	32MJ-32MJ-32FJX	7259-09345	2 1/2-12	2 1/2-12	2 1/2-12

- EQUIPMENT
- HOSE/CPLG. SELECTION
- G8K COUPLINGS
- GLOBAL SPIRAL COUPLINGS
- STAINLESS STEEL SPIRAL
- MEGACRIMP COUPLINGS
- STAINLESS STEEL BRAID
- POWER CRIMP COUPLINGS
- FIELD ATTACHABLE G1 & G2 COUPLINGS
- FIELD ATTACHABLE C5 COUPLINGS
- C14 COUPLINGS
- GL COUPLINGS
- GLX COUPLINGS
- PCTS THERMOPLASTIC COUPLINGS
- POLARSEAL COUPLINGS (ACA)
- POLARSEAL II COUPLINGS (ACC)
- POLARSEAL II COUPLINGS (ACB)
- POWER STEERING
- ADAPTERS
- QUICK DISCONNECT COUPLERS
- BALL VALVES
- LIVE SWIVEL
- ASSEMBLY FABRICATION
- ACCESSORIES
- EQUIPMENT AND PARTS
- KITS
- AIR BRAKE HOSE ASSY
- BRASS



EQUIPMENT
HOSE/CPLG. SELECTION
G8K COUPLINGS
GLOBAL SPIRAL COUPLINGS
STAINLESS STEEL SPIRAL
MEGACRIMP COUPLINGS
STAINLESS STEEL BRAID
POWER CRIMP COUPLINGS
FIELD ATTACHABLE G1 & G2 COUPLINGS
FIELD ATTACHABLE C5 COUPLINGS
C14 COUPLINGS
GL COUPLINGS
GLX COUPLINGS
PCTS THERMOPLASTIC COUPLINGS
POLARSEAL COUPLINGS (ACA)
POLARSEAL II COUPLINGS (ACC)
POLARSEAL II COUPLINGS (ACB)
POWER STEERING
ADAPTERS
QUICK DISCONNECT COUPLERS
BALL VALVES
LIVE SWIVEL
ASSEMBLY FABRICATION
ACCESSORIES
EQUIPMENT AND PARTS
KITS
AIR BRAKE HOSE ASSY
BRASS

### Male JIC 37° Flare on Run to Male JIC 37° Flare Bulkhead - Tee

For use up to SAE 100R2 maximum working pressure.

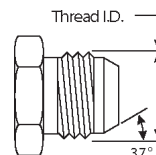
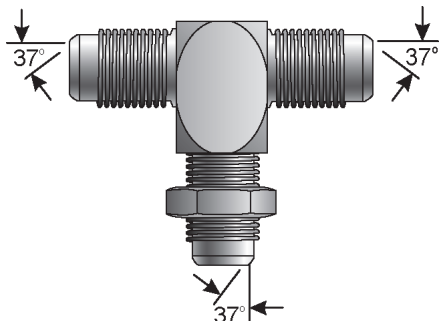

Part No.	Descr.	Prod. No.			
			"	"	"
G60471-0404	4MJ-4MJ-4BKHD	7259-34425	7/16-20	7/16-20	7/16-20
G60471-0505	5MJ-5MJ-5BKHD	7259-34435	1/2-20	1/2-20	1/2-20
G60471-0606	6MJ-6MJ-6BKHD	7259-34445	9/16-18	9/16-18	9/16-18
G60471-0808	8MJ-8MJ-8BKHD	7259-34455	3/4-16	3/4-16	3/4-16
G60471-1010	10MJ-10MJ-10BKHD	7259-34465	7/8-14	7/8-14	7/8-14
G60471-1212	12MJ-12MJ-12BKHD	7259-34475	1 1/16-12	1 1/16-12	1 1/16-12
G60471-1616	16MJ-16MJ-16BKHD	7259-34485	1 5/16-12	1 5/16-12	1 5/16-12

### Male JIC 37° Flare to Male JIC 37° Flare Bulkhead to Male JIC 37° Flare - Tee

For use up to SAE 100R2 maximum working pressure.

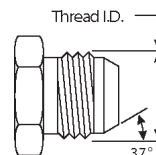
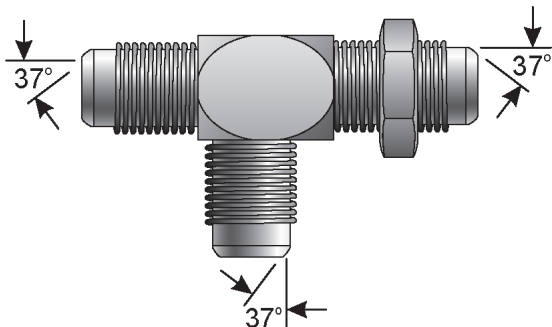



Part No.	Descr.	Prod. No.			
			"	"	"
G60472-0404	4MJ-4BKHD-4MJ	7259-34495	7/16-20	7/16-20	7/16-20
G60472-0606	6MJ-6BKHD-6MJ	7259-34515	9/16-18	9/16-18	9/16-18
G60472-0808	8MJ-8BKHD-8MJ	7259-34525	3/4-16	3/4-16	3/4-16
G60472-1010	10MJ-10BKHD-10MJ	7259-34535	7/8-14	7/8-14	7/8-14
G60472-1212	12MJ-12BKHD-12MJ	7259-34545	1 1/16-12	1 1/16-12	1 1/16-12
G60472-1616	16MJ-16BKHD-16MJ	7259-34555	1 5/16-12	1 5/16-12	1 5/16-12

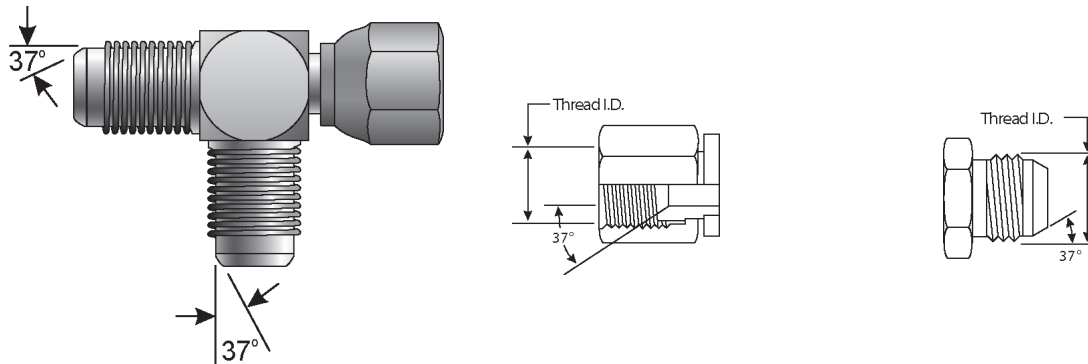

## Male JIC 37° Flare to Female JIC 37° Flare Swivel to Male JIC 37° Flare - Tee

For use up to SAE 100R2 maximum working pressure.



Part No.	Descr.	Prod. No.			
			"	"	"
G60473-0404	4MJ-4FJX-4MJ	7259-24705	7/16-20	7/16-20	7/16-20
G60473-0505	5MJ-5FJX-5MJ	7259-77915	1/2-20	1/2-20	1/2-20
G60473-0606	6MJ-6FJX-6MJ	7259-24725	9/16-18	9/16-18	9/16-18
G60473-0808	8MJ-8FJX-8MJ	7259-24735	3/4-16	3/4-16	3/4-16
G60473-1010	10MJ-10FJX-10MJ	7259-24745	7/8-14	7/8-14	7/8-14
G60473-1212	12MJ-12FJX-12MJ	7259-24755	1 1/16-12	1 1/16-12	1 1/16-12
G60473-1414	14MJ-14FJX-14MJ	7259-08325	1 3/16-12	1 3/16-12	1 3/16-12
G60473-1616	16MJ-16FJX-16MJ	7259-24765	1 5/16-12	1 5/16-12	1 5/16-12
G60473-2020	20MJ-20FJX-20MJ	7259-77925	1 5/8-12	1 5/8-12	1 5/8-12
G60473-2424	24MJ-24FJX-24MJ	7259-07955	1 7/8-12	1 7/8-12	1 7/8-12
G60473-3232	32MJ-32FJX-32MJ	7259-09355	2 1/2-12	2 1/2-12	2 1/2-12

## Male JIC 37° Flare to Male Pipe NPTF

For use up to SAE 100R2 maximum working pressure.

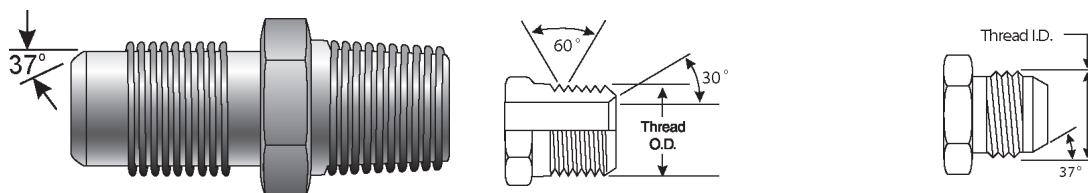

Part No.	Descr.	Prod. No.		
			"	"
G60490-0202	2MJ-2MP	7259-77935	5/16-24	1/8-27
G60490-0302	3MJ-2MP	7259-77945	3/8-24	1/8-27
G60490-0402	4MJ-2MP	7259-10085	7/16-20	1/8-27
G60490-0404	4MJ-4MP	7259-04195	7/16-20	1/4-18
G60490-0406	4MJ-6MP	7259-10385	7/16-20	3/8-18
G60490-0408	4MJ-8MP	7259-70455	7/16-20	1/2-14
G60490-0412	4MJ-12MP	7259-07215	7/16-20	3/4-14
G60490-0502	5MJ-2MP	7259-10995	1/2-20	1/8-27
G60490-0504	5MJ-4MP	7259-10415	1/2-20	1/4-18
G60490-0506	5MJ-6MP	7259-25665	1/2-20	3/8-18
G60490-0508	5MJ-8MP	7259-07835	1/2-20	1/2-14

EQUIPMENT
HOSE/CPLG. SELECTION
G8K COUPLINGS
GLOBALSPIRAL COUPLINGS
STAINLESS STEEL SPIRAL
MEGACRIMP COUPLINGS
STAINLESS STEEL BRAID
POWER CRIMP COUPLINGS
FIELD ATTACHABLE G1 & G2 COUPLINGS
FIELD ATTACHABLE C5 COUPLINGS
C14 COUPLINGS
GL COUPLINGS
GLX COUPLINGS
PCTS THERMOPLASTIC COUPLINGS
POLARSEAL COUPLINGS (ACA)
POLARSEAL II COUPLINGS (ACC)
POLARSEAL II COUPLINGS (ACB)
POWER STEERING
ADAPTERS
QUICK DISCONNECT COUPLERS
BALL VALVES
LIVE SWIVEL
ASSEMBLY FABRICATION
ACCESSORIES
EQUIPMENT AND PARTS
KITS
AIR BRAKE HOSE ASSY
BRASS



Male JIC 37° Flare to Male Pipe NPTF - Continued

EQUIPMENT
HOSE/CPLG. SELECTION
G8K COUPLINGS
GLOBAL SPIRAL COUPLINGS
STAINLESS STEEL SPIRAL
MEGACRIMP COUPLINGS
STAINLESS STEEL BRAID
POWER CRIMP COUPLINGS
FIELD ATTACHABLE G1 & G2 COUPLINGS
FIELD ATTACHABLE C5 COUPLINGS
C14 COUPLINGS
GL COUPLINGS
GLX COUPLINGS
PCTS THERMOPLASTIC COUPLINGS
POLARSEAL COUPLINGS (ACA)
POLARSEAL II COUPLINGS (ACC)
POLARSEAL II COUPLINGS (ACB)
POWER STEERING
ADAPTERS
QUICK DISCONNECT COUPLERS
BALL VALVES
LIVE SWIVEL
ASSEMBLY FABRICATION
ACCESSORIES
EQUIPMENT AND PARTS
KITS
AIR BRAKE HOSE ASSY
BRASS

Part No.	Descr.	Prod. No.		
			"	"
G60490-0602	6MJ-2MP	7259-10565	9/16-18	1/8-27
G60490-0604	6MJ-4MP	7259-25635	9/16-18	1/4-18
G60490-0606	6MJ-6MP	7259-04225	9/16-18	3/8-18
G60490-0608	6MJ-8MP	7259-10205	9/16-18	1/2-14
G60490-0612	6MJ-12MP	7259-00425	9/16-18	3/4-14
G60490-0802	8MJ-2MP	7259-09875	3/4-16	1/8-27
G60490-0804	8MJ-4MP	7259-10435	3/4-16	1/4-18
G60490-0806	8MJ-6MP	7259-10105	3/4-16	3/8-18
G60490-0808	8MJ-8MP	7259-04235	3/4-16	1/2-14
G60490-0812	8MJ-12MP	7259-10545	3/4-16	3/4-14
G60490-0816	8MJ-16MP	7259-05835	3/4-16	1-11 1/2
G60490-1004	10MJ-4MP	7259-07965	7/8-14	1/4-18
G60490-1006	10MJ-6MP	7259-10785	7/8-14	3/8-18
G60490-1008	10MJ-8MP	7259-25715	7/8-14	1/2-14
G60490-1012	10MJ-12MP	7259-10595	7/8-14	3/4-14
G60490-1206	12MJ-6MP	7259-07225	1 1/16-12	3/8-18
G60490-1208	12MJ-8MP	7259-10255	1 1/16-12	1/2-14
G60490-1212	12MJ-12MP	7259-25735	1 1/16-12	3/4-14
G60490-1216	12MJ-16MP	7259-10355	1 1/16-12	1-11 1/2
G60490-1220	12MJ-20MP	7259-05765	1 1/16-12	1 1/4-11 1/2
G60490-1224	12MJ-24MP	7259-07665	1 1/16-12	1 1/2-11 1/2
G60490-1412	14MJ-12MP	7259-77965	1 3/16-12	3/4-14
G60490-1416	14MJ-16MP	7259-07975	1 3/16-12	1-11 1/2
G60490-1608	16MJ-8MP	7259-06095	1 5/16-12	1/2-14
G60490-1612	16MJ-12MP	7259-10485	1 5/16-12	3/4-14
G60490-1616	16MJ-16MP	7259-04275	1 5/16-12	1-11 1/2
G60490-1620	16MJ-20MP	7259-34565	1 5/16-12	1 1/4-11 1/2
G60490-1624	16MJ-24MP	7259-06065	1 5/16-12	1 1/2-11 1/2
G60490-2012	20MJ-12MP	7259-07675	1 5/8-12	3/4-14
G60490-2016	20MJ-16MP	7259-11465	1 5/8-12	1-11 1/2
G60490-2020	20MJ-20MP	7259-10465	1 5/8-12	1 1/4-11 1/2
G60490-2024	20MJ-24MP	7259-34575	1 5/8-12	1 1/2-11 1/2
G60490-2416	24MJ-16MP	7259-07125	1 7/8-12	1-11 1/2
G60490-2420	24MJ-20MP	7259-34585	1 7/8-12	1 1/4-11 1/2
G60490-2424	24MJ-24MP	7259-11245	1 7/8-12	1 1/2-11 1/2
G60490-2432	24MJ-32MP	7259-09375	1 7/8-12	2-11 1/2
G60490-3216	32MJ-16MP	7259-09385	2 1/2-12	1-11 1/2
G60490-3220	32MJ-20MP	7259-09395	2 1/2-12	1 1/4-11 1/2
G60490-3224	32MJ-24MP	7259-34595	2 1/2-12	1 1/2-11 1/2
G60490-3232	32MJ-32MP	7259-11365	2 1/2-12	2-11 1/2



## Male JIC 37° Flare to Male Pipe NPTF - 45°

For use up to SAE 100R2 maximum working pressure.

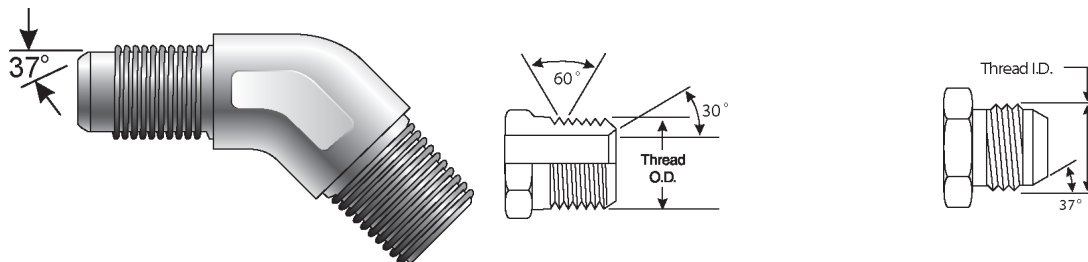

Part No.	Descr.	Prod. No.		
			"	"
G60497-0202	2MJ-2MP45	7259-09415	5/16-24	1/8-27
G60497-0302	3MJ-2MP45	7259-77975	3/8-24	1/8-27
G60497-0402	4MJ-2MP45	7259-10505	7/16-20	1/8-27
G60497-0404	4MJ-4MP45	7259-10825	7/16-20	1/4-18
G60497-0406	4MJ-6MP45	7259-34605	7/16-20	3/8-18
G60497-0408	4MJ-8MP45	7259-09425	7/16-20	1/2-14
G60497-0502	5MJ-2MP45	7259-11635	1/2-20	1/8-27
G60497-0504	5MJ-4MP45	7259-11265	1/2-20	1/4-18
G60497-0506	5MJ-6MP45	7259-07685	1/2-20	3/8-18
G60497-0602	6MJ-2MP45	7259-77985	9/16-18	1/8-27
G60497-0604	6MJ-4MP45	7259-10925	9/16-18	1/4-18
G60497-0606	6MJ-6MP45	7259-10715	9/16-18	3/8-18
G60497-0608	6MJ-8MP45	7259-11135	9/16-18	1/2-14
G60497-0612	6MJ-12MP45	7259-07315	9/16-18	3/4-14
G60497-0804	8MJ-4MP45	7259-77995	3/4-16	1/4-18
G60497-0806	8MJ-6MP45	7259-10695	3/4-16	3/8-18
G60497-0808	8MJ-8MP45	7259-10495	3/4-16	1/2-14
G60497-0812	8MJ-12MP45	7259-11395	3/4-16	3/4-14
G60497-1006	10MJ-6MP45	7259-11505	7/8-14	3/8-18
G60497-1008	10MJ-8MP45	7259-10395	7/8-14	1/2-14
G60497-1012	10MJ-12MP45	7259-34615	7/8-14	3/4-14
G60497-1208	12MJ-8MP45	7259-11375	1 1/16-12	1/2-14
G60497-1212	12MJ-12MP45	7259-10845	1 1/16-12	3/4-14
G60497-1216	12MJ-16MP45	7259-05775	1 1/16-12	1-11 1/2
G60497-1412	14MJ-12MP45	7259-09885	1 3/16-12	3/4-14
G60497-1608	16MJ-8MP45	7259-09435	1 5/16-12	1/2-14
G60497-1612	16MJ-12MP45	7259-11585	1 5/16-12	3/4-14
G60497-1616	16MJ-16MP45	7259-11035	1 5/16-12	1-11 1/2
G60497-1620	16MJ-20MP45	7259-07845	1 5/16-12	1 1/4-11 1/2
G60497-2016	20MJ-16MP45	7259-07985	1 5/8-12	1-11 1/2
G60497-2020	20MJ-20MP45	7259-11485	1 5/8-12	1 1/4-11 1/2
G60497-2024	20MJ-24MP45	7259-08105	1 5/8-12	1 1/2-11 1/2
G60497-2424	24MJ-24MP45	7259-11695	1 7/8-12	1 1/2-11 1/2
G60497-3232	32MJ-32MP45	7259-11675	2 1/2-12	2-11 1/2

- EQUIPMENT
- HOSE/CPLG. SELECTION
- G8K COUPLINGS
- GLOBALSPIRAL COUPLINGS
- STAINLESS STEEL SPIRAL
- MEGACRIMP COUPLINGS
- STAINLESS STEEL BRAID
- POWER CRIMP COUPLINGS
- FIELD ATTACHABLE G1 & G2 COUPLINGS
- FIELD ATTACHABLE C5 COUPLINGS
- C14 COUPLINGS
- GL COUPLINGS
- GLX COUPLINGS
- PCTS THERMOPLASTIC COUPLINGS
- POLARSEAL COUPLINGS (ACA)
- POLARSEAL II COUPLINGS (ACC)
- POLARSEAL II COUPLINGS (ACB)
- POWER STEERING
- ADAPTERS
- QUICK DISCONNECT COUPLERS
- BALL VALVES
- LIVE SWIVEL
- ASSEMBLY FABRICATION
- ACCESSORIES
- EQUIPMENT AND PARTS
- KITS
- AIR BRAKE HOSE ASSY
- BRASS





## Male JIC 37° Flare to Male Pipe NPTF - 90°

For use up to SAE 100R2 maximum working pressure.

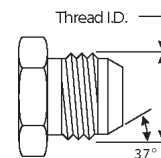
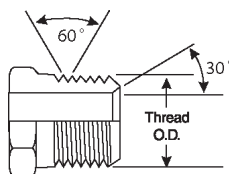
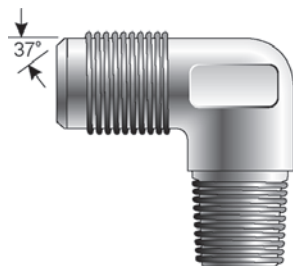

EQUIPMENT
HOSE/CPLG. SELECTION
G8K COUPLINGS
GLOBAL SPIRAL COUPLINGS
STAINLESS STEEL SPIRAL
MEGACRIMP COUPLINGS
STAINLESS STEEL BRAID
POWER CRIMP COUPLINGS
FIELD ATTACHABLE G1 & G2 COUPLINGS
FIELD ATTACHABLE C5 COUPLINGS
C14 COUPLINGS
GL COUPLINGS
GLX COUPLINGS
PCTS THERMOPLASTIC COUPLINGS
POLARSEAL COUPLINGS (ACA)
POLARSEAL II COUPLINGS (ACC)
POLARSEAL II COUPLINGS (ACB)
POWER STEERING
ADAPTERS
QUICK DISCONNECT COUPLERS
BALL VALVES
LIVE SWIVEL
ASSEMBLY FABRICATION
ACCESSORIES
EQUIPMENT AND PARTS
KITS
AIR BRAKE HOSE ASSY
BRASS

Part No.	Descr.	Prod. No.		
			"	"
G60499-0202	2MJ-2MP90	7259-11755	5/16-24	1/8-27
G60499-0302	3MJ-2MP90	7259-78005	3/8-24	1/8-27
G60499-0402	4MJ-2MP90	7259-10175	7/16-20	1/8-27
G60499-0404	4MJ-4MP90	7259-10195	7/16-20	1/4-18
G60499-0406	4MJ-6MP90	7259-34645	7/16-20	3/8-18
G60499-0408	4MJ-8MP90	7259-09815	7/16-20	1/2-14
G60499-0412	4MJ-12MP90	7259-07695	7/16-20	3/4-14
G60499-0502	5MJ-2MP90	7259-11425	1/2-20	1/8-27
G60499-0504	5MJ-4MP90	7259-11045	1/2-20	1/4-18
G60499-0506	5MJ-6MP90	7259-34655	1/2-20	3/8-18
G60499-0602	6MJ-2MP90	7259-11085	9/16-18	1/8-27
G60499-0604	6MJ-4MP90	7259-28385	9/16-18	1/4-18
G60499-0606	6MJ-6MP90	7259-28185	9/16-18	3/8-18
G60499-0608	6MJ-8MP90	7259-10185	9/16-18	1/2-14
G60499-0612	6MJ-12MP90	7259-05545	9/16-18	3/4-14
G60499-0804	8MJ-4MP90	7259-11025	3/4-16	1/4-18
G60499-0806	8MJ-6MP90	7259-10165	3/4-16	3/8-18
G60499-0808	8MJ-8MP90	7259-28205	3/4-16	1/2-14
G60499-0812	8MJ-12MP90	7259-10275	3/4-16	3/4-14
G60499-0816	8MJ-16MP90	7259-07575	3/4-16	1-11 1/2
G60499-1006	10MJ-6MP90	7259-11195	7/8-14	3/8-18
G60499-1008	10MJ-8MP90	7259-28375	7/8-14	1/2-14
G60499-1012	10MJ-12MP90	7259-10555	7/8-14	3/4-14
G60499-1016	10MJ-16MP90	7259-07705	7/8-14	1-11 1/2
G60499-1206	12MJ-6MP90	7259-07995	1 1/16-12	3/8-18
G60499-1208	12MJ-8MP90	7259-10795	1 1/16-12	1/2-14
G60499-1212	12MJ-12MP90	7259-28395	1 1/16-12	3/4-14
G60499-1216	12MJ-16MP90	7259-34665	1 1/16-12	1-11 1/2
G60499-1220	12MJ-20MP90	7259-06835	1 1/16-12	1 1/4-11 1/2
G60499-1408	14MJ-8MP90	7259-09445	1 3/16-12	1/2-14
G60499-1412	14MJ-12MP90	7259-07585	1 3/16-12	3/4-14
G60499-1608	16MJ-8MP90	7259-09455	1 5/16-12	1/2-14
G60499-1612	16MJ-12MP90	7259-11205	1 5/16-12	3/4-14
G60499-1616	16MJ-16MP90	7259-28405	1 5/16-12	1-11 1/2
G60499-1620	16MJ-20MP90	7259-34675	1 5/16-12	1 1/4-11 1/2
G60499-1624	16MJ-24MP90	7259-07715	1 5/16-12	1 1/2-11 1/2
G60499-2016	20MJ-16MP90	7259-11565	1 5/8-12	1-11 1/2
G60499-2020	20MJ-20MP90	7259-10905	1 5/8-12	1 1/4-11 1/2
G60499-2024	20MJ-24MP90	7259-34685	1 5/8-12	1 1/2-11 1/2
G60499-2420	24MJ-20MP90	7259-34695	1 7/8-12	1 1/4-11 1/2
G60499-2424	24MJ-24MP90	7259-11445	1 7/8-12	1 1/2-11 1/2
G60499-3224	32MJ-24MP90	7259-08335	2 1/2-12	1 1/2-11 1/2
G60499-3232	32MJ-32MP90	7259-11685	2 1/2-12	2-11 1/2



## Male JIC 37° Flare to Female Pipe NPTF

For use up to SAE 100R2 maximum working pressure.

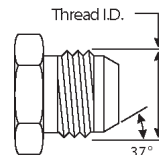
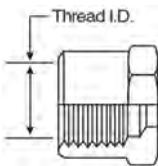
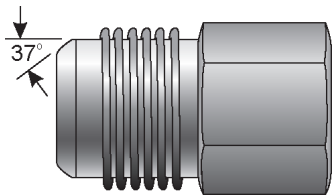

Part No.	Descr.	Prod. No.		
			"	"
G60510-0202	2MJ-2FP	7259-78015	5/16-24	1/8-27
G60510-0302	3MJ-2FP	7259-08515	3/8-24	1/8-27
G60510-0304	3MJ-4FP	7259-08525	3/8-24	1/4-18
G60510-0402	4MJ-2FP	7259-11165	7/16-20	1/8-27
G60510-0404	4MJ-4FP	7259-10965	7/16-20	1/4-18
G60510-0406	4MJ-6FP	7259-06915	7/16-20	3/8-18
G60510-0408	4MJ-8FP	7259-09475	7/16-20	1/2-14
G60510-0502	5MJ-2FP	7259-11665	1/2-20	1/8-27
G60510-0504	5MJ-4FP	7259-11615	1/2-20	1/4-18
G60510-0602	6MJ-2FP	7259-09485	9/16-18	1/8-27
G60510-0604	6MJ-4FP	7259-10515	9/16-18	1/4-18
G60510-0606	6MJ-6FP	7259-10685	9/16-18	3/8-18
G60510-0608	6MJ-8FP	7259-34715	9/16-18	1/2-14
G60510-0804	8MJ-4FP	7259-09495	3/4-16	1/4-18
G60510-0806	8MJ-6FP	7259-10945	3/4-16	3/8-18
G60510-0808	8MJ-8FP	7259-10605	3/4-16	1/2-14
G60510-0812	8MJ-12FP	7259-34725	3/4-16	3/4-14
G60510-1006	10MJ-6FP	7259-34735	7/8-14	3/8-18
G60510-1008	10MJ-8FP	7259-10805	7/8-14	1/2-14
G60510-1012	10MJ-12FP	7259-34745	7/8-14	3/4-14
G60510-1208	12MJ-8FP	7259-34755	1 1/16-12	1/2-14
G60510-1212	12MJ-12FP	7259-10675	1 1/16-12	3/4-14
G60510-1216	12MJ-16FP	7259-06655	1 1/16-12	1-11 1/2
G60510-1412	14MJ-12FP	7259-08345	1 3/16-12	3/4-14
G60510-1612	16MJ-12FP	7259-07005	1 5/16-12	3/4-14
G60510-1616	16MJ-16FP	7259-10985	1 5/16-12	1-11 1/2
G60510-1620	16MJ-20FP	7259-34765	1 5/16-12	1 1/4-11 1/2
G60510-2016	20MJ-16FP	7259-08535	1 5/8-12	1-11 1/2
G60510-2020	20MJ-20FP	7259-25925	1 5/8-12	1 1/4-11 1/2
G60510-2424	24MJ-24FP	7259-25935	1 7/8-12	1 1/2-11 1/2
G60510-3232	32MJ-32FP	7259-34775	2 1/2-12	2-11 1/2

- EQUIPMENT
- HOSE/CPLG. SELECTION
- G8K COUPLINGS
- GLOBALSPIRAL COUPLINGS
- STAINLESS STEEL SPIRAL
- MEGACRIMP COUPLINGS
- STAINLESS STEEL BRAID
- POWER CRIMP COUPLINGS
- FIELD ATTACHABLE G1 & G2 COUPLINGS
- FIELD ATTACHABLE C5 COUPLINGS
- C14 COUPLINGS
- GL COUPLINGS
- GLX COUPLINGS
- PCTS THERMOPLASTIC COUPLINGS
- POLARSEAL COUPLINGS (ACA)
- POLARSEAL II COUPLINGS (ACC)
- POLARSEAL II COUPLINGS (ACB)
- POWER STEERING
- ADAPTERS
- QUICK DISCONNECT COUPLERS
- BALL VALVES
- LIVE SWIVEL
- ASSEMBLY FABRICATION
- ACCESSORIES
- EQUIPMENT AND PARTS
- KITS
- AIR BRAKE HOSE ASSY
- BRASS



### Male JIC 37° Flare to Female Pipe NPTF - 90°

For use up to SAE 100R2 maximum working pressure.

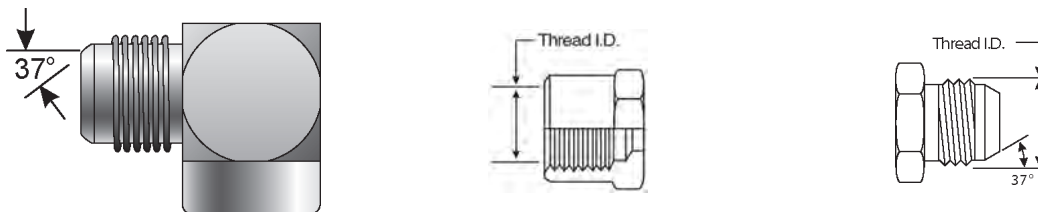

Part No.	Descr.	Prod. No.		
			"	"
G60514-0402	4MJ-2FP90	7259-25105	7/16-20	1/8-27
G60514-0404	4MJ-4FP90	7259-34785	7/16-20	1/4-18
G60514-0502	5MJ-2FP90	7259-07365	1/2-20	1/8-27
G60514-0504	5MJ-4FP90	7259-34805	1/2-20	1/4-18
G60514-0602	6MJ-2FP90	7259-09505	9/16-18	1/8-27
G60514-0604	6MJ-4FP90	7259-25115	9/16-18	1/4-18
G60514-0606	6MJ-6FP90	7259-34825	9/16-18	3/8-18
G60514-0608	6MJ-8FP90	7259-00405	9/16-18	1/2-14
G60514-0804	8MJ-4FP90	7259-09515	3/4-16	1/4-18
G60514-0806	8MJ-6FP90	7259-25125	3/4-16	3/8-18
G60514-0808	8MJ-8FP90	7259-34835	3/4-16	1/2-14
G60514-1008	10MJ-8FP90	7259-25135	7/8-14	1/2-14
G60514-1208	12MJ-8FP90	7259-34845	1 1/16-12	1/2-14
G60514-1212	12MJ-12FP90	7259-25145	1 1/16-12	3/4-14
G60514-1412	14MJ-12FP90	7259-09525	1 3/16-12	3/4-14
G60514-1616	16MJ-16FP90	7259-25155	1 5/16-12	1-11 1/2
G60514-2020	20MJ-20FP90	7259-34855	1 5/8-12	1 1/4-11 1/2
G60514-2424	24MJ-24FP90	7259-07725	1 7/8-12	1 1/2-11 1/2

### Female JIC 37° Flare Swivel to Male Pipe NPTF

For use up to SAE 100R2 maximum working pressure.

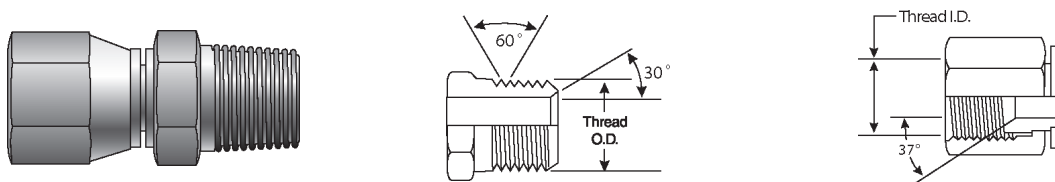



Part No.	Descr.	Prod. No.		
			"	"
G60520-0402	4FJX-2MP	7253-34865	7/16-20	1/8-27
G60520-0404	4FJX-4MP	7259-34875	7/16-20	1/4-18
G60520-0604	6FJX-4MP	7259-34885	9/16-18	1/4-18
G60520-0606	6FJX-6MP	7259-34895	9/16-18	3/8-18
G60520-0806	8FJX-6MP	7259-34905	3/4-16	3/8-18
G60520-0808	8FJX-8MP	7259-34915	3/4-16	1/2-14
G60520-1008	10FJX-8MP	7259-09565	7/8-14	1/2-14
G60520-1208	12FJX-8MP	7259-51055	1 1/16-12	1/2-14
G60520-1212	12FJX-12MP	7259-34925	1 1/16-12	3/4-14
G60520-1616	16FJX-16MP	7253-34935	1 5/16-12	1-11 1/2
G60520-2020	20FJX-20MP	7259-34945	1 5/8-12	1 1/4-11 1/2

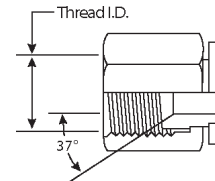
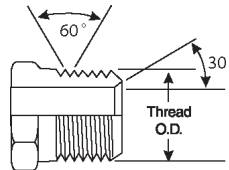
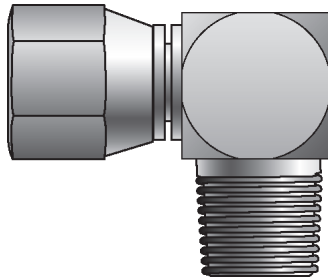

## Female JIC 37° Flare Swivel to Male Pipe NPTF - 90°

For use up to SAE 100R2 maximum working pressure.



Part No.	Descr.	Prod. No.		
			"	"
G60524-0402	4FJX-2MP90	7253-34955	7/16-20	1/8-27
G60524-0404	4FJX-4MP90	7259-05325	7/16-20	1/4-18
G60524-0604	6FJX-4MP90	7253-34965	9/16-18	1/4-18
G60524-0606	6FJX-6MP90	7253-34975	9/16-18	3/8-18
G60524-0806	8FJX-6MP90	7253-34985	3/4-16	3/8-18
G60524-0808	8FJX-8MP90	7253-34995	3/4-16	1/2-14
G60524-1008	10FJX-8MP90	7253-35015	7/8-14	1/2-14
G60524-1212	12FJX-12MP90	7253-35025	1 1/16-12	3/4-14
G60524-1616	16FJX-16MP90	7259-35285	1 5/16-12	1-11 1/2
G60524-2020	20FJX-20MP90	7259-35295	1 5/8-12	1 1/4-11 1/2
G60524-2424	24FJX-24MP90	7259-35035	1 7/8-12	1 1/2-11 1/2

## Female JIC 37° Flare Swivel to Female Pipe NPTF

For use up to SAE 100R2 maximum working pressure.

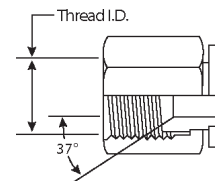
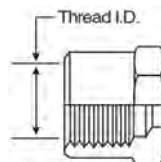
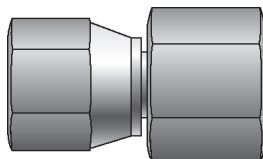

Part No.	Descr.	Prod. No.		
			"	"
G60530-0402	4FJX-2FP	7253-35045	7/16-20	1/8-27
G60530-0404	4FJX-4FP	7253-35055	7/16-20	1/4-18
G60530-0606	6FJX-6FP	7253-35075	9/16-18	3/8-18
G60530-0806	8FJX-6FP	7253-35095	3/4-16	3/8-18
G60530-0808	8FJX-8FP	7253-35105	3/4-16	1/2-14
G60530-1008	10FJX-8FP	7253-35115	7/8-14	1/2-14
G60530-1212	12FJX-12FP	7253-35125	1 1/16-12	3/4-14
G60530-1616	16FJX-16FP	7259-35135	1 5/16-12	1-11 1/2
G60530-2020	20FJX-20FP	7259-35145	1 5/8-12	1 1/4-11 1/2

- EQUIPMENT
- HOSE/CPLG. SELECTION
- G8K COUPLINGS
- GLOBALSPIRAL COUPLINGS
- STAINLESS STEEL SPIRAL
- MEGACRIMP COUPLINGS
- STAINLESS STEEL BRAID
- POWER CRIMP COUPLINGS
- FIELD ATTACHABLE G1 & G2 COUPLINGS
- FIELD ATTACHABLE C5 COUPLINGS
- C14 COUPLINGS
- GL COUPLINGS
- GLX COUPLINGS
- PCTS THERMOPLASTIC COUPLINGS
- POLARSEAL COUPLINGS (ACA)
- POLARSEAL II COUPLINGS (ACC)
- POLARSEAL II COUPLINGS (ACB)
- POWER STEERING
- ADAPTERS
- QUICK DISCONNECT COUPLERS
- BALL VALVES
- LIVE SWIVEL
- ASSEMBLY FABRICATION
- ACCESSORIES
- EQUIPMENT AND PARTS
- KITS
- AIR BRAKE HOSE ASSY
- BRASS



EQUIPMENT
HOSE/CPLG. SELECTION
G8K COUPLINGS
GLOBAL SPIRAL COUPLINGS
STAINLESS STEEL SPIRAL
MEGACRIMP COUPLINGS
STAINLESS STEEL BRAID
POWER CRIMP COUPLINGS
FIELD ATTACHABLE G1 & G2 COUPLINGS
FIELD ATTACHABLE C5 COUPLINGS
C14 COUPLINGS
GL COUPLINGS
GLX COUPLINGS
PCTS THERMOPLASTIC COUPLINGS
POLARSEAL COUPLINGS (ACA)
POLARSEAL II COUPLINGS (ACC)
POLARSEAL II COUPLINGS (ACB)
POWER STEERING
ADAPTERS
QUICK DISCONNECT COUPLERS
BALL VALVES
LIVE SWIVEL
ASSEMBLY FABRICATION
ACCESSORIES
EQUIPMENT AND PARTS
KITS
AIR BRAKE HOSE ASSY
BRASS

### Male JIC 37° Flare Bulkhead to Male Pipe NPTF

For use up to SAE 100R2 maximum working pressure.

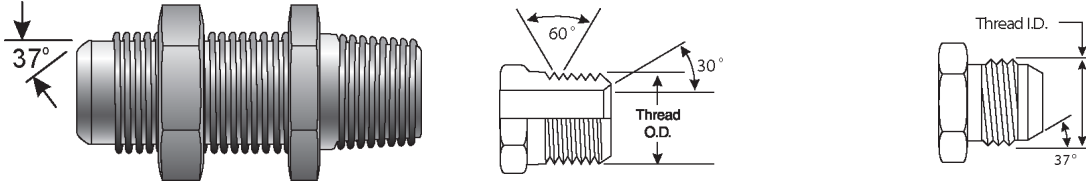

Part No.	Descr.	Prod. No.	NPTF	
			"	"
G60541-0402	4MJBKHD-2MP	7259-09945	7/16-20	1/8-27
G60541-0404	4MJBKHD-4MP	7259-35155	7/16-20	1/4-18
G60541-0604	6MJBKHD-4MP	7259-35165	9/16-18	1/4-18
G60541-0806	8MJBKHD-6MP	7259-35175	3/4-16	3/8-18
G60541-0808	8MJBKHD-8MP	7259-09905	3/4-16	1/2-14
G60541-1008	10MJBKHD-8MP	7259-35185	7/8-14	1/2-14
G60541-1208	12MJBKHD-8MP	7259-35275	1 1/16-12	1/2-14
G60541-1212	12MJBKHD-12MP	7259-35195	1 1/16-12	3/4-14
G60541-1616	16MJBKHD-16MP	7253-35205	1 5/16-12	1-11 1/2
G60541-2020	20MJBKHD-20MP	7259-09965	1 5/8-12	1 1/4-11 1/2

### Male JIC 37° Flare on Run to Male Pipe NPTF - Tee

For use up to SAE 100R2 maximum working pressure.

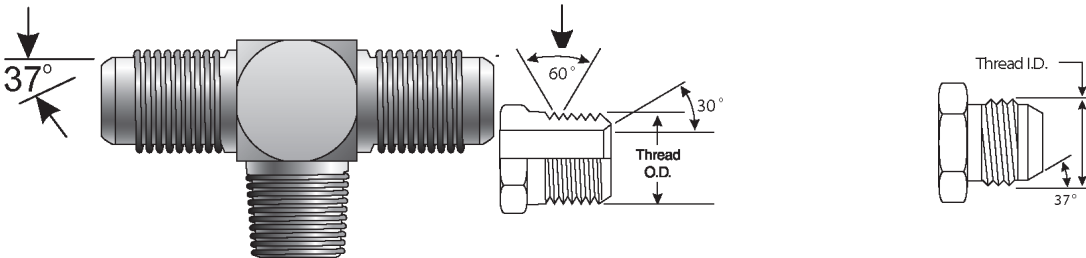

Part No.	Descr.	Prod. No.	NPTF		
			"	"	"
G60551-0302	3MJ-3MJ-2MP	7259-09605	3/8-24	3/8-24	1/8-27
G60551-0402	4MJ-4MJ-2MP	7259-23415	7/16-20	7/16-20	1/8-27
G60551-0404	4MJ-4MJ-4MP	7259-35215	7/16-20	7/16-20	1/4-18
G60551-0406	4MJ-4MJ-6MP	7259-05855	7/16-20	7/16-20	3/8-18
G60551-0502	5MJ-5MJ-2MP	7259-07385	1/2-20	1/2-20	1/8-27
G60551-0504	5MJ-5MJ-4MP	7259-35225	1/2-20	1/2-20	1/4-18
G60551-0604	6MJ-6MJ-4MP	7259-23425	9/16-18	9/16-18	1/4-18
G60551-0606	6MJ-6MJ-6MP	7259-35235	9/16-18	9/16-18	3/8-18
G60551-0608	6MJ-6MJ-8MP	7259-35245	9/16-18	9/16-18	1/2-14
G60551-0806	8MJ-8MJ-6MP	7259-23435	3/4-16	3/4-16	3/8-18
G60551-0808	8MJ-8MJ-8MP	7259-35255	3/4-16	3/4-16	1/2-14
G60551-0812	8MJ-8MJ-12MP	7259-09615	3/4-16	3/4-16	3/4-14
G60551-1008	10MJ-10MJ-8MP	7259-23445	7/8-14	7/8-14	1/2-14
G60551-1208	12MJ-12MJ-8MP	7259-07395	1 1/16-12	1 1/16-12	1/2-14
G60551-1212	12MJ-12MJ-12MP	7259-23455	1 1/16-12	1 1/16-12	3/4-14
G60551-1216	12MJ-12MJ-16MP	7259-07735	1 1/16-12	1 1/16-12	1-11 1/2
G60551-1412	14MJ-14MJ-12MP	7259-09625	1 3/16-12	1 3/16-12	3/4-14
G60551-1612	16MJ-16MJ-12MP	7259-09635	1 5/16-12	1 5/16-12	3/4-14





### Male JIC 37° Flare on Run to Male Pipe NPTF - Tee - Continued

Part No.	Descr.	Prod. No.			
			"	"	"
G60551-1616	16MJ-16MJ-16MP	7259-23465	1 5/16-12	1 5/16-12	1-11 1/2
G60551-2020	20MJ-20MJ-20MP	7259-35265	1 5/8-12	1 5/8-12	1 1/4-11 1/2
G60551-2424	24MJ-24MJ-24MP	7259-08355	1 7/8-12	1 7/8-12	1 1/2-11 1/2

### Female Flat-Face O-Ring Cap

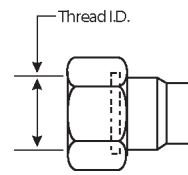
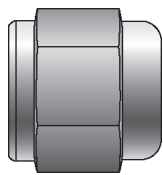
For use up to SAE 100R2 maximum working pressure.



Part No.	Descr.	Prod. No.	
			"
G60701-0004	4FFOR-CAP	7253-32125	9/16-18
G60701-0006	6FFOR-CAP	7253-32135	11/16-16
G60701-0008	8FFOR-CAP	7253-32145	13/16-16
G60701-0010	10FFOR-CAP	7253-32155	1-14
G60701-0012	12FFOR-CAP	7253-32165	1 3/16-12
G60701-0016	16FFOR-CAP	7253-32175	1 7/16-12
G60701-0020	20FFOR-CAP	7253-32185	1 11/16-12
G60701-0024	24FFOR-CAP	7253-32195	2-12

### Male Flat-Face O-Ring Plug

For use up to SAE 100R2 maximum working pressure.

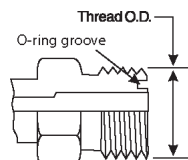
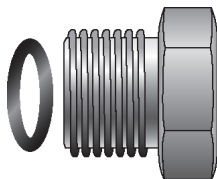

Part No.	Descr.	Prod. No.	
			"
G60702-0004	4MFFOR-PLUG	7259-32045	9/16-18
G60702-0006	6MFFOR-PLUG	7259-32055	11/16-16
G60702-0008	8MFFOR-PLUG	7259-32065	13/16-16
G60702-0010	10MFFOR-PLUG	7259-32075	1-14
G60702-0012	12MFFOR-PLUG	7259-32085	1 3/16-12
G60702-0016	16MFFOR-PLUG	7259-32095	1 7/16-12
G60702-0020	20MFFOR-PLUG	7259-32105	1 11/16-12
G60702-0024	24MFFOR-PLUG	7259-32115	2-12
G60702-0032	32MFFOR-PLUG	7259-09655	2 1/2-12

EQUIPMENT
HOSE/CPLG. SELECTION
G8K COUPLINGS
GLOBAL SPIRAL COUPLINGS
STAINLESS STEEL SPIRAL
MEGACRIMP COUPLINGS
STAINLESS STEEL BRAID
POWER CRIMP COUPLINGS
FIELD ATTACHABLE G1 & G2 COUPLINGS
FIELD ATTACHABLE C5 COUPLINGS
C14 COUPLINGS
GL COUPLINGS
GLX COUPLINGS
PCTS THERMOPLASTIC COUPLINGS
POLARSEAL COUPLINGS (ACA)
POLARSEAL II COUPLINGS (ACC)
POLARSEAL II COUPLINGS (ACB)
POWER STEERING
ADAPTERS
QUICK DISCONNECT COUPLERS
BALL VALVES
LIVE SWIVEL
ASSEMBLY FABRICATION
ACCESSORIES
EQUIPMENT AND PARTS
KITS
AIR BRAKE HOSE ASSY
BRASS



EQUIPMENT
HOSE/CPLG. SELECTION
G8K COUPLINGS
GLOBALSPIRAL COUPLINGS
STAINLESS STEEL SPIRAL
MEGACRIMP COUPLINGS
STAINLESS STEEL BRAID
POWER CRIMP COUPLINGS
FIELD ATTACHABLE G1 & G2 COUPLINGS
FIELD ATTACHABLE C5 COUPLINGS
C14 COUPLINGS
GL COUPLINGS
GLX COUPLINGS
PCTS THERMOPLASTIC COUPLINGS
POLARSEAL COUPLINGS (ACA)
POLARSEAL II COUPLINGS (ACC)
POLARSEAL II COUPLINGS (ACB)
POWER STEERING
ADAPTERS
QUICK DISCONNECT COUPLERS
BALL VALVES
LIVE SWIVEL
ASSEMBLY FABRICATION
ACCESSORIES
EQUIPMENT AND PARTS
KITS
AIR BRAKE HOSE ASSY
BRASS

## Male Flat-Face O-Ring to Male Flat-Face O-Ring

For use up to SAE 100R2 maximum working pressure.

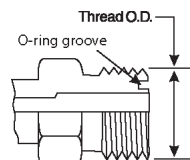

Part No.	Descr.	Prod. No.		
			"	"
G60705-0404	4MFFOR-4MFFOR	7259-43965	9/16-18	9/16-18
G60705-0604	6MFFOR-4MFFOR	7259-43975	11/16-16	9/16-18
G60705-0606	6MFFOR-6MFFOR	7259-43985	11/16-16	11/16-16
G60705-0806	8MFFOR-6MFFOR	7259-43995	13/16-16	11/16-16
G60705-0808	8MFFOR-8MFFOR	7259-44005	13/16-16	13/16-16
G60705-1010	10MFFOR-10MFFOR	7259-44025	1-14	1-14
G60705-1212	12MFFOR-12MFFOR	7259-44045	1 3/16-12	1 3/16-12
G60705-1616	16MFFOR-16MFFOR	7259-44065	1 7/16-12	1 7/16-12
G60705-2020	20MFFOR-20MFFOR	7259-44075	1 11/16-12	1 11/16-12
G60705-2424	24MFFOR-24MFFOR	7259-44085	2-12	2-12

## Male Flat-Face O-Ring to Male Flat-Face O-Ring - 90°

For use up to SAE 100R2 maximum working pressure.

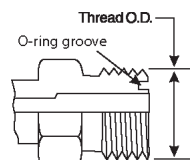
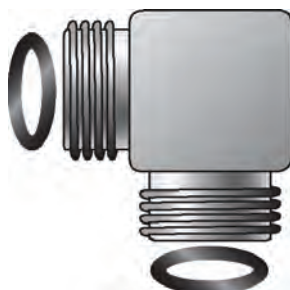

Part No.	Descr.	Prod. No.		
			"	"
G60712-0404	4MFFOR-4MFFOR90	7259-44105	9/16-18	9/16-18
G60712-0808	8MFFOR-8MFFOR90	7259-44125	13/16-16	13/16-16





## Male Flat-Face O-Ring to Female Flat-Face Swivel - 90°

For use up to SAE 100R2 maximum working pressure.

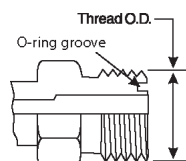
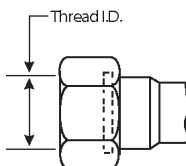
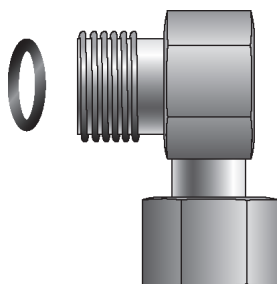

Part No.	Descr.	Prod. No.			
			"	"	"
G60724-0404	4MFFOR-4FFORX90	7259-06075	9/16-18	9/16-18	9/16-18
G60724-0606	6MFFOR-6FFORX90	7259-31905	11/16-16	11/16-16	11/16-16
G60724-0808	8MFFOR-8FFORX90	7259-00345	13/16-16	13/16-16	13/16-16
G60724-1010	10MFFOR-10FFORX90	7259-05585	1-14	1-14	1-14
G60724-1212	12MFFOR-12FFORX90	7259-06085	1 3/16-12	1 3/16-12	1 3/16-12
G60724-1616	16MFFOR-16FFORX90	7259-05285	1 7/16-12	1 7/16-12	1 7/16-12
G60724-2020	20MFFOR-20FFORX90	7259-09665	1 11/16-12	1 11/16-12	1 11/16-12
G60724-2424	24MFFOR-24FFORX90	7259-09675	2-12	2-12	2-12

## Male Flat-Face O-Ring Tee

For use up to SAE 100R2 maximum working pressure.

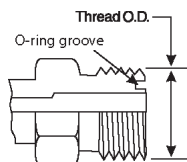

Part No.	Descr.	Prod. No.			
			"	"	"
G60740-0404	4MFFOR-4MFFOR-4MFFOR	7259-04805	9/16-18	9/16-18	9/16-18
G60740-0606	6MFFOR-6MFFOR-6MFFOR	7259-04815	11/16-16	11/16-16	11/16-16
G60740-0808	8MFFOR-8MFFOR-8MFFOR	7259-04825	13/16-16	13/16-16	13/16-16
G60740-1010	10MFFOR-10MFFOR-10MFFOR	7259-04835	1-14	1-14	1-14
G60740-1212	12MFFOR-12MFFOR-12MFFOR	7259-04845	1 3/16-12	1 3/16-12	1 3/16-12
G60740-1616	16MFFOR-16MFFOR-16MFFOR	7259-04855	1 7/16-12	1 7/16-12	1 7/16-12
G60740-2020	20MFFOR-20MFFOR-20MFFOR	7259-04865	1 11/16-12	1 11/16-12	1 11/16-12

EQUIPMENT
HOSE/CPLG. SELECTION
G8K COUPLINGS
GLOBALSPIRAL COUPLINGS
STAINLESS STEEL SPIRAL
MEGACRIMP COUPLINGS
STAINLESS STEEL BRAID
POWER CRIMP COUPLINGS
FIELD ATTACHABLE G1 & G2 COUPLINGS
FIELD ATTACHABLE C5 COUPLINGS
C14 COUPLINGS
GL COUPLINGS
GLX COUPLINGS
PCTS THERMOPLASTIC COUPLINGS
POLARSEAL COUPLINGS (ACA)
POLARSEAL II COUPLINGS (ACC)
POLARSEAL II COUPLINGS (ACB)
POWER STEERING
ADAPTERS
QUICK DISCONNECT COUPLERS
BALL VALVES
LIVE SWIVEL
ASSEMBLY FABRICATION
ACCESSORIES
EQUIPMENT AND PARTS
KITS
AIR BRAKE HOSE ASSY
BRASS



EQUIPMENT
HOSE/CPLG. SELECTION
G8K COUPLINGS
GLOBAL SPIRAL COUPLINGS
STAINLESS STEEL SPIRAL
MEGACRIMP COUPLINGS
STAINLESS STEEL BRAID
POWER CRIMP COUPLINGS
FIELD ATTACHABLE G1 & G2 COUPLINGS
FIELD ATTACHABLE C5 COUPLINGS
C14 COUPLINGS
GL COUPLINGS
GLX COUPLINGS
PCTS THERMOPLASTIC COUPLINGS
POLARSEAL COUPLINGS (ACA)
POLARSEAL II COUPLINGS (ACC)
POLARSEAL II COUPLINGS (ACB)
POWER STEERING
ADAPTERS
QUICK DISCONNECT COUPLERS
BALL VALVES
LIVE SWIVEL
ASSEMBLY FABRICATION
ACCESSORIES
EQUIPMENT AND PARTS
KITS
AIR BRAKE HOSE ASSY
BRASS

## Male Flat-Face O-Ring on Run to Female Flat-Face Swivel - Tee

For use up to SAE 100R2 maximum working pressure.

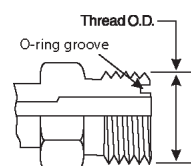
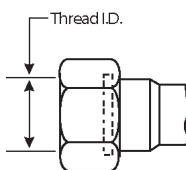
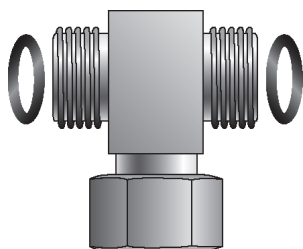

Part No.	Descr.	Prod. No.			
			"	"	"
G60742-0404	4MFFOR-4MFFOR-4FFORX	7259-31805	9/16-18	9/16-18	9/16-18
G60742-0606	6MFFOR-6MFFOR-6FFORX	7259-31815	11/16-16	11/16-16	11/16-16
G60742-0808	8MFFOR-8MFFOR-8FFORX	7259-31825	13/16-16	13/16-16	13/16-16
G60742-1010	10MFFOR-10MFFOR-10FFORX	7259-09685	1-14	1-14	1-14
G60742-1212	12MFFOR-12MFFOR-12FFORX	7259-09695	1 3/16-12	1 3/16-12	1 3/16-12
G60742-1616	16MFFOR-16MFFOR-16FFORX	7259-09705	1 7/16-12	1 7/16-12	1 7/16-12
G60742-2020	20MFFOR-20MFFOR-20FFORX	7259-09715	1 11/16-12	1 11/16-12	1 11/16-12

## Male Flat-Face O-Ring to Female Flat-Face O-Ring to Male Flat-Face O-Ring - Tee

For use up to SAE 100R2 maximum working pressure.

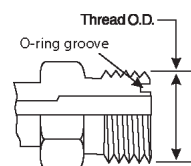
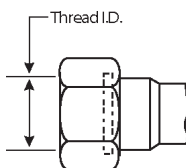
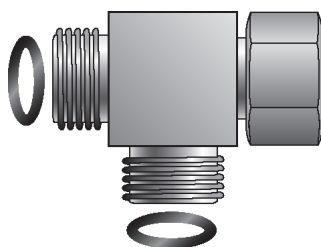



Part No.	Descr.	Prod. No.			
			"	"	"
G60744-0404	4MFFOR-4FFORX-4MFFOR	7259-00265	9/16-18	9/16-18	9/16-18
G60744-0606	6MFFOR-6FFORX-6MFFOR	7259-00135	11/16-16	11/16-16	11/16-16
G60744-0808	8MFFOR-8FFORX-8MFFOR	7259-00225	13/16-16	13/16-16	13/16-16
G60744-1010	10MFFOR-10FFORX-10MFFOR	7259-06815	1-14	1-14	1-14
G60744-1212	12MFFOR-12FFORX-12MFFOR	7259-00555	1 3/16-12	1 3/16-12	1 3/16-12
G60744-1616	16MFFOR-16FFORX-16MFFOR	7259-06025	1 7/16-12	1 7/16-12	1 7/16-12
G60744-2020	20MFFOR-20FFORX-20MFFOR	7259-04785	1 11/16-12	1 11/16-12	1 11/16-12

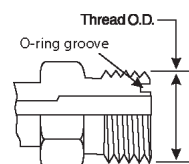
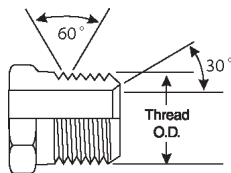
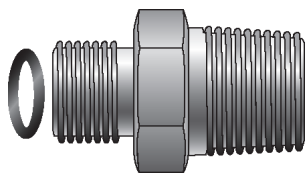

## Male Flat-Face O-Ring to Male Pipe NPTF

For use up to SAE 100R2 maximum working pressure.



Part No.	Descr.	Prod. No.		
			"	"
G60770-0402	4MFFOR-2MP	7259-30615	9/16-18	1/8-27
G60770-0404	4MFFOR-4MP	7259-30625	9/16-18	1/4-18
G60770-0406	4MFFOR-6MP	7259-30635	9/16-18	3/8-18
G60770-0604	6MFFOR-4MP	7259-30645	11/16-16	1/4-18
G60770-0606	6MFFOR-6MP	7259-30655	11/16-16	3/8-18
G60770-0608	6MFFOR-8MP	7259-30665	11/16-16	1/2-14
G60770-0804	8MFFOR-4MP	7259-09845	13/16-16	1/4-18
G60770-0806	8MFFOR-6MP	7259-30675	13/16-16	3/8-18
G60770-0808	8MFFOR-8MP	7259-30685	13/16-16	1/2-14
G60770-0812	8MFFOR-12MP	7259-06845	13/16-16	3/4-14
G60770-1008	10MFFOR-8MP	7259-30695	1-14	1/2-14
G60770-1012	10MFFOR-12MP	7259-06755	1-14	3/4-14
G60770-1208	12MFFOR-8MP	7259-06035	1 3/16-12	1/2-14
G60770-1212	12MFFOR-12MP	7259-30705	1 3/16-12	3/4-14
G60770-1216	12MFFOR-16MP	7259-08115	1 3/16-12	1-11 1/2
G60770-1612	16MFFOR-12MP	7259-07075	1 7/16-12	3/4-14
G60770-1616	16MFFOR-16MP	7259-30715	1 7/16-12	1-11 1/2
G60770-2020	20MFFOR-20MP	7259-30725	1 11/16-12	1 1/4-11 1/2
G60770-2424	24MFFOR-24MP	7259-07595	2-12	1 1/2-11 1/2

## Male Flat-Face O-Ring to Female JIC 37° Flare Swivel

For use up to SAE 100R2 maximum working pressure.

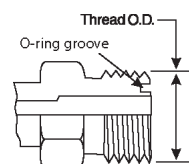
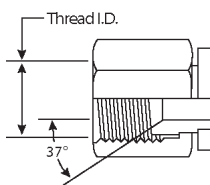
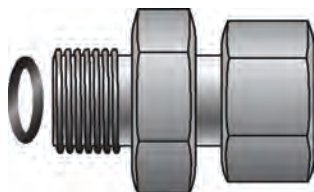

Part No.	Descr.	Prod. No.		
			"	"
G60785-0404	4MFFOR-4FJX	7259-09995	9/16-18	7/16-20
G60785-0606	6MFFOR-6FJX	7259-05135	11/16-16	9/16-18
G60785-0808	8MFFOR-8FJX	7259-05365	13/16-16	3/4-16
G60785-1010	10MFFOR-10FJX	7259-06335	1-14	7/8-14
G60785-1212	12MFFOR-12FJX	7259-05215	1 3/16-12	1 1/16-12
G60785-1616	16MFFOR-16FJX	7259-06765	1 7/16-12	1 5/16-12

- EQUIPMENT
- HOSE/CPLG. SELECTION
- G8K COUPLINGS
- GLOBALSPIRAL COUPLINGS
- STAINLESS STEEL SPIRAL
- MEGACRIMP COUPLINGS
- STAINLESS STEEL BRAID
- POWER CRIMP COUPLINGS
- FIELD ATTACHABLE G1 & G2 COUPLINGS
- FIELD ATTACHABLE C5 COUPLINGS
- C14 COUPLINGS
- GL COUPLINGS
- GLX COUPLINGS
- PCTS THERMOPLASTIC COUPLINGS
- POLARSEAL COUPLINGS (ACA)
- POLARSEAL II COUPLINGS (ACC)
- POLARSEAL II COUPLINGS (ACB)
- POWER STEERING
- ADAPTERS
- QUICK DISCONNECT COUPLERS
- BALL VALVES
- LIVE SWIVEL
- ASSEMBLY FABRICATION
- ACCESSORIES
- EQUIPMENT AND PARTS
- KITS
- AIR BRAKE HOSE ASSY
- BRASS



## Male Flat-Face O-Ring to Male O-Ring Boss

For use up to SAE 100R2 maximum working pressure.

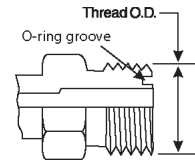
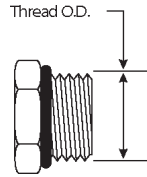
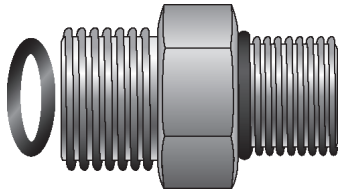

EQUIPMENT
HOSE/CPLG. SELECTION
G8K COUPLINGS
GLOBAL SPIRAL COUPLINGS
STAINLESS STEEL SPIRAL
MEGACRIMP COUPLINGS
STAINLESS STEEL BRAID
POWER CRIMP COUPLINGS
FIELD ATTACHABLE G1 & G2 COUPLINGS
FIELD ATTACHABLE C5 COUPLINGS
C14 COUPLINGS
GL COUPLINGS
GLX COUPLINGS
PCTS THERMOPLASTIC COUPLINGS
POLARSEAL COUPLINGS (ACA)
POLARSEAL II COUPLINGS (ACC)
POLARSEAL II COUPLINGS (ACB)
POWER STEERING
ADAPTERS
QUICK DISCONNECT COUPLERS
BALL VALVES
LIVE SWIVEL
ASSEMBLY FABRICATION
ACCESSORIES
EQUIPMENT AND PARTS
KITS
AIR BRAKE HOSE ASSY
BRASS

Part No.	Descr.	Prod. No.		
			"	"
G60800-0404	4MFFOR-4MB	7259-30015	9/16-18	7/16-20
G60800-0406	4MFFOR-6MB	7259-29905	9/16-18	9/16-18
G60800-0408	4MFFOR-8MB	7259-30115	9/16-18	3/4-16
G60800-0604	6MFFOR-4MB	7259-30025	11/16-16	7/16-20
G60800-0606	6MFFOR-6MB	7259-00085	11/16-16	9/16-18
G60800-0608	6MFFOR-8MB	7259-29925	11/16-16	3/4-16
G60800-0610	6MFFOR-10MB	7259-30095	11/16-16	7/8-14
G60800-0806	8MFFOR-6MB	7259-30035	13/16-16	9/16-18
G60800-0808	8MFFOR-8MB	7259-29915	13/16-16	3/4-16
G60800-0810	8MFFOR-10MB	7259-30105	13/16-16	7/8-14
G60800-0812	8MFFOR-12MB	7259-30125	13/16-16	1 1/16-12
G60800-0816	8MFFOR-16MB	7259-08005	13/16-16	1 5/16-12
G60800-1008	10MFFOR-8MB	7259-00155	1-14	3/4-16
G60800-1010	10MFFOR-10MB	7259-30045	1-14	7/8-14
G60800-1012	10MFFOR-12MB	7259-00165	1-14	1 1/16-12
G60800-1208	12MFFOR-8MB	7259-30135	1 3/16-12	3/4-16
G60800-1210	12MFFOR-10MB	7259-05385	1 3/16-12	7/8-14
G60800-1212	12MFFOR-12MB	7259-30055	1 3/16-12	1 1/16-12
G60800-1216	12MFFOR-16MB	7259-30175	1 3/16-12	1 5/16-12
G60800-1612	16MFFOR-12MB	7259-30185	1 7/16-12	1 1/16-12
G60800-1616	16MFFOR-16MB	7259-50255	1 7/16-12	1 5/16-12
G60800-1620	16MFFOR-20MB	7259-00045	1 7/16-12	1 5/8-12
G60800-2016	20MFFOR-16MB	7259-30145	1 11/16-12	1 5/16-12
G60800-2020	20MFFOR-20MB	7259-30075	1 11/16-12	1 5/8-12
G60800-2024	20MFFOR-24MB	7259-09745	1 11/16-12	1 7/8-12
G60800-2420	24MFFOR-20MB	7259-09755	2-12	1 5/8-12
G60800-2424	24MFFOR-24MB	7259-00175	2-12	1 7/8-12
G60800-3232	32MFFOR-32MB	7259-00325	2 1/2-12	2 1/2-12



### Male Flat-Face O-Ring to Male O-Ring Boss - 45°

For use up to SAE 100R2 maximum working pressure.

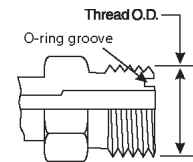
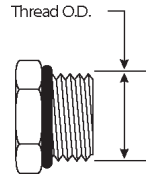
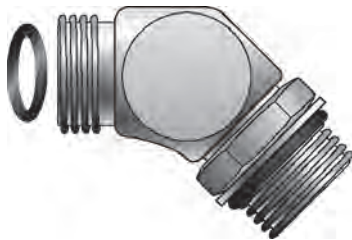

Part No.	Descr.	Prod. No.		
			"	"
G60805-0404	4MFFOR-4MB45	7259-30935	9/16-18	7/16-20
G60805-0406	4MFFOR-6MB45	7259-30305	9/16-18	9/16-18
G60805-0604	6MFFOR-4MB45	7259-30945	11/16-16	7/16-20
G60805-0606	6MFFOR-6MB45	7259-30225	11/16-16	9/16-18
G60805-0608	6MFFOR-8MB45	7259-30955	11/16-16	3/4-16
G60805-0806	8MFFOR-6MB45	7259-30965	13/16-16	9/16-18
G60805-0808	8MFFOR-8MB45	7259-30975	13/16-16	3/4-16
G60805-0810	8MFFOR-10MB45	7259-30295	13/16-16	7/8-14
G60805-0812	8MFFOR-12MB45	7259-30985	13/16-16	1 1/16-12
G60805-1008	10MFFOR-8MB45	7259-30995	1-14	3/4-16
G60805-1010	10MFFOR-10MB45	7259-31005	1-14	7/8-14
G60805-1012	10MFFOR-12MB45	7259-31015	1-14	1 1/16-12
G60805-1210	12MFFOR-10MB45	7259-31025	1 3/16-12	7/8-14
G60805-1212	12MFFOR-12MB45	7259-31035	1 3/16-12	1 1/16-12
G60805-1216	12MFFOR-16MB45	7259-31045	1 3/16-12	1 5/16-12
G60805-1612	16MFFOR-12MB45	7259-31055	1 7/16-12	1 1/16-12
G60805-1616	16MFFOR-16MB45	7259-31065	1 7/16-12	1 5/16-12
G60805-1620	16MFFOR-20MB45	7259-31075	1 7/16-12	1 5/8-12
G60805-2020	20MFFOR-20MB45	7259-31085	1 11/16-12	1 5/8-12
G60805-2424	24MFFOR-24MB45	7259-31095	2-12	1 7/8-12

### Male Flat-Face O-Ring to Male O-Ring Boss - 90°

For use up to SAE 100R2 maximum working pressure.

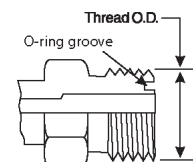
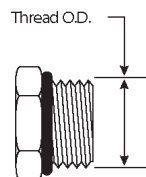
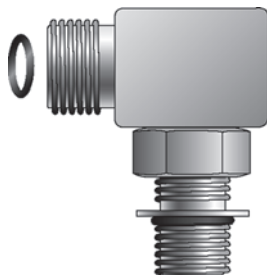

Part No.	Descr.	Prod. No.		
			"	"
G60810-0404	4MFFOR-4MB90	7259-30415	9/16-18	7/16-20
G60810-0406	4MFFOR-6MB90	7259-30735	9/16-18	9/16-18
G60810-0408	4MFFOR-8MB90	7259-30745	9/16-18	3/4-16
G60810-0604	6MFFOR-4MB90	7259-30495	11/16-16	7/16-20
G60810-0606	6MFFOR-6MB90	7259-30425	11/16-16	9/16-18

- EQUIPMENT
- HOSE/CPLG. SELECTION
- G8K COUPLINGS
- GLOBALSPIRAL COUPLINGS
- STAINLESS STEEL SPIRAL
- MEGACRIMP COUPLINGS
- STAINLESS STEEL BRAID
- POWER CRIMP COUPLINGS
- FIELD ATTACHABLE G1 & G2 COUPLINGS
- FIELD ATTACHABLE C5 COUPLINGS
- C14 COUPLINGS
- GL COUPLINGS
- GLX COUPLINGS
- PCTS THERMOPLASTIC COUPLINGS
- POLARSEAL COUPLINGS (ACA)
- POLARSEAL II COUPLINGS (ACC)
- POLARSEAL II COUPLINGS (ACB)
- POWER STEERING
- ADAPTERS
- QUICK DISCONNECT COUPLERS
- BALL VALVES
- LIVE SWIVEL
- ASSEMBLY FABRICATION
- ACCESSORIES
- EQUIPMENT AND PARTS
- KITS
- AIR BRAKE HOSE ASSY
- BRASS



Male Flat-Face O-Ring to Male O-Ring Boss - 90° - Continued

EQUIPMENT
HOSE/CPLG. SELECTION
G8K COUPLINGS
GLOBAL SPIRAL COUPLINGS
STAINLESS STEEL SPIRAL
MEGACRIMP COUPLINGS
STAINLESS STEEL BRAID
POWER CRIMP COUPLINGS
FIELD ATTACHABLE G1 & G2 COUPLINGS
FIELD ATTACHABLE C5 COUPLINGS
C14 COUPLINGS
GL COUPLINGS
GLX COUPLINGS
PCTS THERMOPLASTIC COUPLINGS
POLARSEAL COUPLINGS (ACA)
POLARSEAL II COUPLINGS (ACC)
POLARSEAL II COUPLINGS (ACB)
POWER STEERING
ADAPTERS
QUICK DISCONNECT COUPLERS
BALL VALVES
LIVE SWIVEL
ASSEMBLY FABRICATION
ACCESSORIES
EQUIPMENT AND PARTS
KITS
AIR BRAKE HOSE ASSY
BRASS

Part No.	Descr.	Prod. No.		
			"	"
G60810-0608	6MFFOR-8MB90	7259-30755	1 1/16-16	3/4-16
G60810-0612	6MFFOR-12MB90	7259-30765	1 1/16-16	1 1/16-12
G60810-0806	8MFFOR-6MB90	7259-66215	13/16-16	9/16-18
G60810-0808	8MFFOR-8MB90	7259-30435	13/16-16	3/4-16
G60810-0810	8MFFOR-10MB90	7259-30515	13/16-16	7/8-14
G60810-0812	8MFFOR-12MB90	7259-30525	13/16-16	1 1/16-12
G60810-1008	10MFFOR-8MB90	7259-30555	1-14	3/4-16
G60810-1010	10MFFOR-10MB90	7259-30445	1-14	7/8-14
G60810-1012	10MFFOR-12MB90	7259-30775	1-14	1 1/16-12
G60810-1208	12MFFOR-8MB90	7259-30785	1 3/16-12	3/4-16
G60810-1210	12MFFOR-10MB90	7259-30795	1 3/16-12	7/8-14
G60810-1212	12MFFOR-12MB90	7259-30455	1 3/16-12	1 1/16-12
G60810-1216	12MFFOR-16MB90	7259-30805	1 3/16-12	1 5/16-12
G60810-1612	16MFFOR-12MB90	7259-30545	1 7/16-12	1 1/16-12
G60810-1616	16MFFOR-16MB90	7259-30465	1 7/16-12	1 5/16-12
G60810-1620	16MFFOR-20MB90	7259-30815	1 7/16-12	1 5/8-12
G60810-2016	20MFFOR-16MB90	7259-30825	1 11/16-12	1 5/16-12
G60810-2020	20MFFOR-20MB90	7259-30475	1 11/16-12	1 5/8-12
G60810-2024	20MFFOR-24MB90	7259-30835	1 11/16-12	1 7/8-12
G60810-2420	24MFFOR-20MB90	7259-30845	2-12	1 5/8-12
G60810-2424	24MFFOR-24MB90	7259-30855	2-12	1 7/8-12

Male Flat-Face O-Ring to Male O-Ring Boss - 90° Long Drop

For use up to SAE 100R2 maximum working pressure.

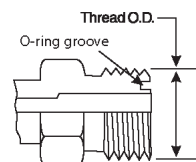
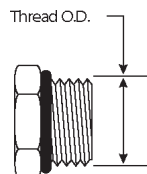
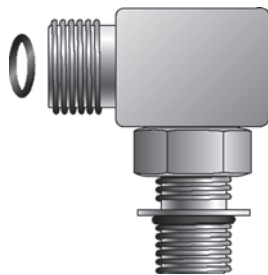

Part No.	Descr.	Prod. No.		
			"	"
G60811-0404	4MFFOR-4MB90L	7259-30875	9/16-18	7/16-20
G60811-0606	6MFFOR-6MB90L	7259-30885	11/16-16	9/16-18
G60811-1212	12MFFOR-12MB90L	7259-30915	1 3/16-12	1 1/16-12
G60811-1616	16MFFOR-16MB90L	7259-30925	1 7/16-12	1 5/16-12



### Male Flat-Face O-Ring on Run to Male O-Ring Boss - Tee

For use up to SAE 100R2 maximum working pressure.

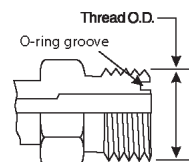
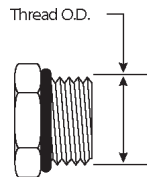
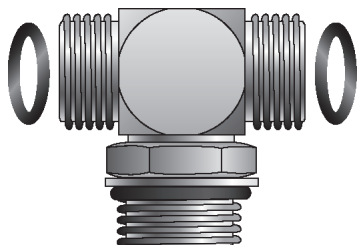

Part No.	Descr.	Prod. No.			
			"	"	"
G60820-0404	4MFFOR-4MFFOR-4MB	7259-31405	9/16-18	9/16-18	7/16-20
G60820-0606	6MFFOR-6MFFOR-6MB	7259-31515	11/16-16	11/16-16	9/16-18
G60820-0808	8MFFOR-8MFFOR-8MB	7259-31415	13/16-16	13/16-16	3/4-16
G60820-1010	10MFFOR-10MFFOR-10MB	7259-31425	1-14	1-14	7/8-14
G60820-1212	12MFFOR-12MFFOR-12MB	7259-31545	1 3/16-12	1 3/16-12	1 1/16-12
G60820-1616	16MFFOR-16MFFOR-16MB	7259-31555	1 7/16-12	1 7/16-12	1 5/16-12
G60820-2020	20MFFOR-20MFFOR-20MB	7259-31435	1 11/16-12	1 11/16-12	1 5/8-12

### Male Flat-Face O-Ring to Male O-Ring Boss to Male Flat-Face O-Ring - Tee

For use up to SAE 100R2 maximum working pressure.

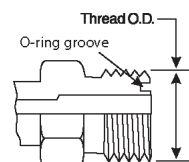
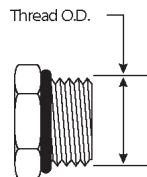
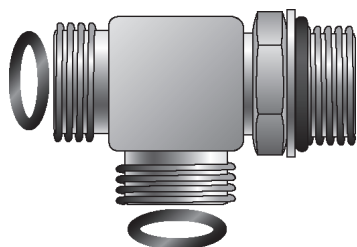

Part No.	Descr.	Prod. No.			
			"	"	"
G60821-0404	4MFFOR-4MB-4MFFOR	7259-31455	9/16-18	7/16-20	9/16-18
G60821-0606	6MFFOR-6MB-6MFFOR	7259-31605	11/16-16	9/16-18	11/16-16
G60821-0808	8MFFOR-8MB-8MFFOR	7259-31465	13/16-16	3/4-16	13/16-16
G60821-1010	10MFFOR-10MB-10MFFOR	7259-31615	1-14	7/8-14	1-14
G60821-1212	12MFFOR-12MB-12MFFOR	7259-31475	1 3/16-12	1 1/16-12	1 3/16-12
G60821-1616	16MFFOR-16MB-16MFFOR	7259-31485	1 7/16-12	1 5/16-12	1 7/16-12
G60821-2020	20MFFOR-20MB-20MFFOR	7259-31495	1 11/16-12	1 5/8-12	1 11/16-12
G60821-2424	24MFFOR-24MB-24MFFOR	7259-31505	2-12	1 7/8-12	2-12

EQUIPMENT
HOSE/CPLG. SELECTION
G8K COUPLINGS
GLOBALSPIRAL COUPLINGS
STAINLESS STEEL SPIRAL
MEGACRIMP COUPLINGS
STAINLESS STEEL BRAID
POWER CRIMP COUPLINGS
FIELD ATTACHABLE G1 & G2 COUPLINGS
FIELD ATTACHABLE C5 COUPLINGS
C14 COUPLINGS
GL COUPLINGS
GLX COUPLINGS
PCTS THERMOPLASTIC COUPLINGS
POLARSEAL COUPLINGS (ACA)
POLARSEAL II COUPLINGS (ACC)
POLARSEAL II COUPLINGS (ACB)
POWER STEERING
ADAPTERS
QUICK DISCONNECT COUPLERS
BALL VALVES
LIVE SWIVEL
ASSEMBLY FABRICATION
ACCESSORIES
EQUIPMENT AND PARTS
KITS
AIR BRAKE HOSE ASSY
BRASS



## Female Flat-Face Swivel to Male JIC 37° Flare

For use up to SAE 100R2 maximum working pressure.

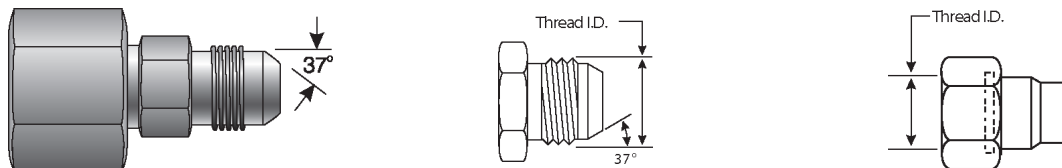

Part No.	Descr.	Prod. No.		
			"	"
G60880-0404	4FFORX-4MJ	7253-31705	9/16-18	7/16-20
G60880-0606	6FFORX-6MJ	7253-31715	11/16-16	9/16-18
G60880-0808	8FFORX-8MJ	7253-31725	13/16-16	3/4-16
G60880-1010	10FFORX-10MJ	7253-31735	1-14	7/8-14
G60880-1212	12FFORX-12MJ	7253-31745	1 3/16-12	1 1/16-12
G60880-1616	16FFORX-16MJ	7253-31755	1 7/16-12	1 5/16-12

EQUIPMENT
HOSE/CPLG. SELECTION
G8K COUPLINGS
GLOBAL SPIRAL COUPLINGS
STAINLESS STEEL SPIRAL
MEGACRIMP COUPLINGS
STAINLESS STEEL BRAID
POWER CRIMP COUPLINGS
FIELD ATTACHABLE G1 & G2 COUPLINGS
FIELD ATTACHABLE C5 COUPLINGS
C14 COUPLINGS
GL COUPLINGS
GLX COUPLINGS
PCTS THERMOPLASTIC COUPLINGS
POLARSEAL COUPLINGS (ACA)
POLARSEAL II COUPLINGS (ACC)
POLARSEAL II COUPLINGS (ACB)
POWER STEERING
<b>ADAPTERS</b>
QUICK DISCONNECT COUPLERS
BALL VALVES
LIVE SWIVEL
ASSEMBLY FABRICATION
ACCESSORIES
EQUIPMENT AND PARTS
KITS
AIR BRAKE HOSE ASSY
BRASS





### Code 61 O-Ring Flange to Male JIC 37° Flare

O-Ring not included. Must be ordered separately.

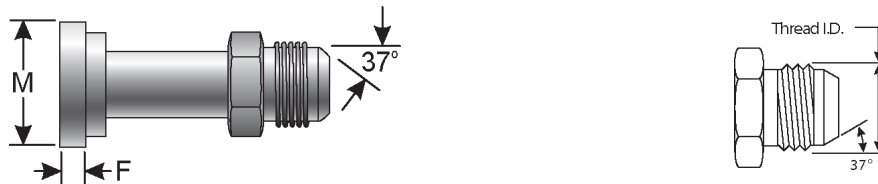

Part No.	Descr.	Prod. No.		M		F	
				"	mm	"	mm
G60900-0808	8FL-8MJ	7253-86931	3/4-16	1.19	30.2	.27	6.9
G60900-1212	12FL-12MJ	7253-86932	1 1/16-12	1.50	38.1	.27	6.9
G60900-1616	16FL-16MJ	7253-86933	1 5/16-12	1.75	44.5	.32	8.1
G60900-2020	20FL-20MJ	7253-86934	1 5/8-12	2.00	50.8	.32	8.1
G60900-2424	24FL-24MJ	7253-86935	1 7/8-12	2.38	60.5	.32	8.1
G60900-3232	32FL-32MJ	7253-86936	2 1/2-12	2.81	71.4	.38	9.7

### Code 61 O-Ring Flange to Male JIC 37° Flare - High Pressure

No braze joints, solid one-piece construction for increased reliability.  
O-Ring not included. Must be ordered separately.

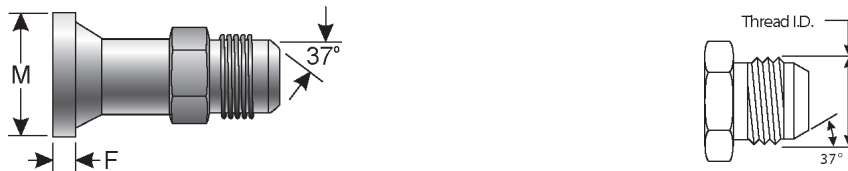

Part No.	Descr.	Prod. No.		M		F	
				"	mm	"	mm
G60901-1212	12FL5K-12MJ	7253-13015	1 1/16-12	1.50	38.1	.27	6.9
G60901-1612	16FL5K-12MJ	7253-12405	1 1/16-12	1.75	44.5	.32	8.1
G60901-1616	16FL5K-16MJ	7253-13035	1 5/16-12	1.75	44.5	.32	8.1
G60901-1620	16FL5K-20MJ	7253-12425	1 5/8-12	1.75	44.5	.32	8.1
G60901-2016	20FL4K-16MJ	7253-12485	1 5/16-12	2.00	50.8	.32	8.1
G60901-2020	20FL4K-20MJ	7253-12475	1 5/8-12	2.00	50.8	.32	8.1

NOTE: FL5K maximum working pressure is 5,000 psi; FL4K maximum working pressure is 4,000 psi.

- EQUIPMENT
- HOSE/CPLG. SELECTION
- G8K COUPLINGS
- GLOBALSPIRAL COUPLINGS
- STAINLESS STEEL SPIRAL
- MEGACRIMP COUPLINGS
- STAINLESS STEEL BRAID
- POWER CRIMP COUPLINGS
- FIELD ATTACHABLE G1 & G2 COUPLINGS
- FIELD ATTACHABLE C5 COUPLINGS
- C14 COUPLINGS
- GL COUPLINGS
- GLX COUPLINGS
- PCTS THERMOPLASTIC COUPLINGS
- POLARSEAL COUPLINGS (ACA)
- POLARSEAL II COUPLINGS (ACC)
- POLARSEAL II COUPLINGS (ACB)
- POWER STEERING
- ADAPTERS
- QUICK DISCONNECT COUPLERS
- BALL VALVES
- LIVE SWIVEL
- ASSEMBLY FABRICATION
- ACCESSORIES
- EQUIPMENT AND PARTS
- KITS
- AIR BRAKE HOSE ASSY
- BRASS



EQUIPMENT
HOSE/CPLG. SELECTION
G8K COUPLINGS
GLOBAL SPIRAL COUPLINGS
STAINLESS STEEL SPIRAL
MEGACRIMP COUPLINGS
STAINLESS STEEL BRAID
POWER CRIMP COUPLINGS
FIELD ATTACHABLE G1 & G2 COUPLINGS
FIELD ATTACHABLE C5 COUPLINGS
C14 COUPLINGS
GL COUPLINGS
GLX COUPLINGS
PCTS THERMOPLASTIC COUPLINGS
POLARSEAL COUPLINGS (ACA)
POLARSEAL II COUPLINGS (ACC)
POLARSEAL II COUPLINGS (ACB)
POWER STEERING
ADAPTERS
QUICK DISCONNECT COUPLERS
BALL VALVES
LIVE SWIVEL
ASSEMBLY FABRICATION
ACCESSORIES
EQUIPMENT AND PARTS
KITS
AIR BRAKE HOSE ASSY
BRASS

### Code 61 O-Ring Flange to Male JIC 37° Flare - 45°

O-Ring not included. Must be ordered separately.

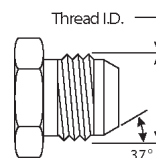
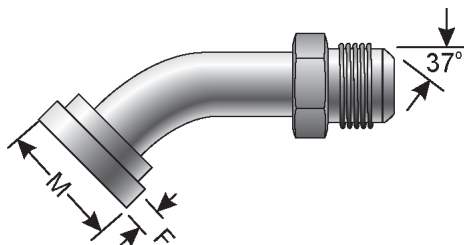

Part No.	Descr.	Prod. No.	Flare	M		F	
				"	mm	"	mm
G60905-0808	8FL-8MJ45	7253-86937	3/4-16	1.19	30.2	.27	6.9
G60905-1212	12FL-12MJ45	7253-86938	1 1/16-12	1.50	38.1	.27	6.9
G60905-1616	16FL-16MJ45	7253-86939	1 5/16-12	1.75	44.5	.32	8.1
G60905-2020	20FL-20MJ45	7253-86941	1 5/8-12	2.00	50.8	.32	8.1
G60905-2424	24FL-24MJ45	7253-86942	1 7/8-12	2.38	60.5	.32	8.1
G60905-3232	32FL-32MJ45	7253-86943	2 1/2-12	2.81	71.4	.38	9.7

### Code 61 O-Ring Flange to Male JIC 37° Flare - 45° - High Pressure

No braze joints, solid one-piece construction for increased reliability.  
O-Ring not included. Must be ordered separately.

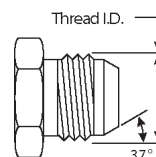
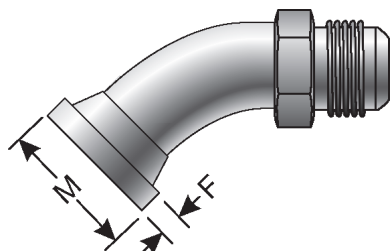

Part No.	Descr.	Prod. No.	Flare	M		F	
				"	mm	"	mm
G60906-1212	12FL5K-12MJ45	7253-13105	1 1/16-12	1.50	38.1	.27	6.9
G60906-1616	16FL5K-16MJ45	7253-13125	1 5/16-12	1.75	44.5	.32	8.1
G60906-2016	20FL4K-16MJ45	7253-12625	1 5/16-12	2.00	50.8	.37	9.4
G60906-2020	20FL4K-20MJ45	7253-12395	1 5/8-12	2.00	50.8	.37	9.4

NOTE: FL5K maximum working pressure is 5,000 psi; FL4K maximum working pressure is 4,000 psi.



### Code 61 O-Ring Flange to Male JIC 37° Flare - 90°

O-Ring not included. Must be ordered separately.

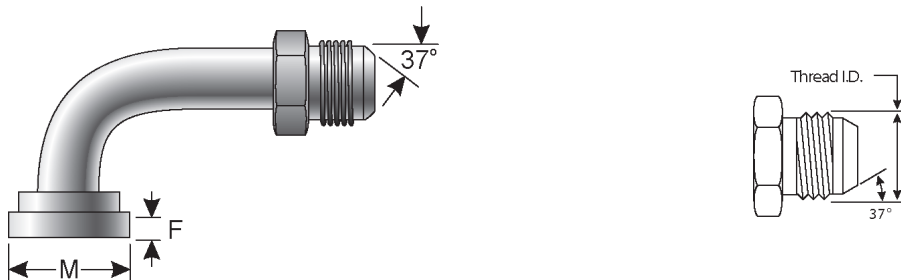

Part No.	Descr.	Prod. No.	M		F		
			"	mm	"	mm	
G60910-0808	8FL-8MJ90	7253-86944	3/4-16	1.19	30.2	.27	6.9
G60910-1212	12FL-12MJ90	7253-86945	1 1/16-12	1.50	38.1	.27	6.9
G60910-1616	16FL-16MJ90	7253-86946	1 5/16-12	1.75	44.5	.32	8.1
G60910-2020	20FL-20MJ90	7253-86947	1 5/8-12	2.00	50.8	.32	8.1
G60910-2424	24FL-24MJ90	7253-86948	1 7/8-12	2.38	60.5	.32	8.1
G60910-3232	32FL-32MJ90	7253-86949	2 1/2-12	2.81	71.4	.38	9.7

### Code 61 O-Ring Flange to Male JIC 37° Flare - 90° - High Pressure

No braze joints, solid one-piece construction for increased reliability.  
O-Ring not included. Must be ordered separately.

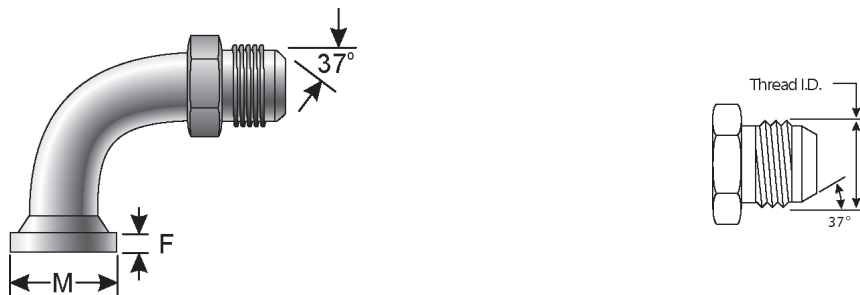

Part No.	Descr.	Prod. No.	M		F		
			"	mm	"	mm	
G60911-1212	12FL5K-12MJ90	7253-13205	1 1/16-12	1.50	38.1	.27	6.9
G60911-1612	16FL5K-12MJ90	7253-12415	1 1/16-12	1.75	44.5	.32	8.1
G60911-1616	16FL5K-16MJ90	7253-13225	1 5/16-12	1.75	44.5	.32	8.1
G60911-2016	20FL4K-16MJ90	7253-12495	1 5/16-12	2.00	50.8	.32	8.1
G60911-2020	20FL4K-20MJ90	7253-12505	1 5/8-12	2.00	50.8	.32	8.1

NOTE: FL5K maximum working pressure is 5,000 psi; FL4K maximum working pressure is 4,000 psi.

- EQUIPMENT
- HOSE/CPLG. SELECTION
- G8K COUPLINGS
- GLOBALSPIRAL COUPLINGS
- STAINLESS STEEL SPIRAL
- MEGACRIMP COUPLINGS
- STAINLESS STEEL BRAID
- POWER CRIMP COUPLINGS
- FIELD ATTACHABLE G1 & G2 COUPLINGS
- FIELD ATTACHABLE C5 COUPLINGS
- C14 COUPLINGS
- GL COUPLINGS
- GLX COUPLINGS
- PCTS THERMOPLASTIC COUPLINGS
- POLARSEAL COUPLINGS (ACA)
- POLARSEAL II COUPLINGS (ACC)
- POLARSEAL II COUPLINGS (ACB)
- POWER STEERING
- ADAPTERS
- QUICK DISCONNECT COUPLERS
- BALL VALVES
- LIVE SWIVEL
- ASSEMBLY FABRICATION
- ACCESSORIES
- EQUIPMENT AND PARTS
- KITS
- AIR BRAKE HOSE ASSY
- BRASS



## Code 61 O-Ring Flange to Male Flat-Face O-Ring - High Pressure

For use up to SAE 100R2 maximum working pressure.  
 No braze joints, solid one-piece construction for increased reliability.  
 O-Ring not included. Must be ordered separately.

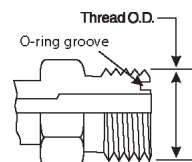
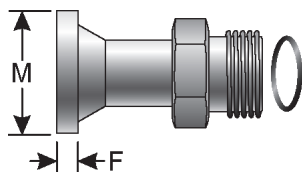

Part No.	Descr.	Prod. No.	🌀	M		F	
				"	mm	"	mm
G60915-1212	12FL5K-12MFFOR	7253-13695	1 3/16-12	1.50	38.1	.27	6.9
G60915-1612	16FL5K-12MFFOR	7253-17155	1 3/16-12	1.75	44.5	.32	8.1
G60915-1616	16FL5K-16MFFOR	7253-13705	1 7/16-12	1.75	44.5	.32	8.1
G60915-2020	20FL4K-20MFFOR	7253-13715	1 11/16-12	2.00	50.8	.32	8.1

NOTE: FL5K maximum working pressure is 5,000 psi; FL4K maximum working pressure is 4,000 psi.

## Code 61 O-Ring Flange to Male Flat-Face O-Ring 45° - High Pressure

No braze joints, solid one-piece construction for increased reliability.  
 O-Ring not included. Must be ordered separately.

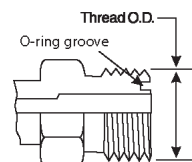
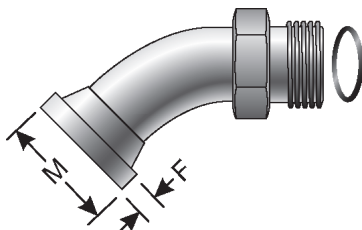

Part No.	Descr.	Prod. No.	🌀	M		F	
				"	mm	"	mm
G60920-1212	12FL5K-12MFFOR45	7253-13725	1 3/16-12	1.50	38.1	.27	6.9
G60920-1616	16FL5K-16MFFOR45	7253-13735	1 7/16-12	1.75	44.5	.32	8.1
G60920-2020	20FL4K-20MFFOR45	7253-13745	1 11/16-12	2.00	50.8	.32	8.1

NOTE: FL5K maximum working pressure is 5,000 psi; FL4K maximum working pressure is 4,000 psi.

EQUIPMENT
HOSE/CPLG. SELECTION
G8K COUPLINGS
GLOBAL SPIRAL COUPLINGS
STAINLESS STEEL SPIRAL
MEGACRIMP COUPLINGS
STAINLESS STEEL BRAID
POWER CRIMP COUPLINGS
FIELD ATTACHABLE G1 & G2 COUPLINGS
FIELD ATTACHABLE C5 COUPLINGS
C14 COUPLINGS
GL COUPLINGS
GLX COUPLINGS
PCTS THERMOPLASTIC COUPLINGS
POLARSEAL COUPLINGS (ACA)
POLARSEAL II COUPLINGS (ACC)
POLARSEAL II COUPLINGS (ACB)
POWER STEERING
ADAPTERS
QUICK DISCONNECT COUPLERS
BALL VALVES
LIVE SWIVEL
ASSEMBLY FABRICATION
ACCESSORIES
EQUIPMENT AND PARTS
KITS
AIR BRAKE HOSE ASSY
BRASS



### Code 61 O-Ring Flange to Male Flat-Face O-Ring 90° - High Pressure

No braze joints, solid one-piece construction for increased reliability.  
O-Ring not included. Must be ordered separately.

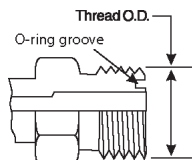
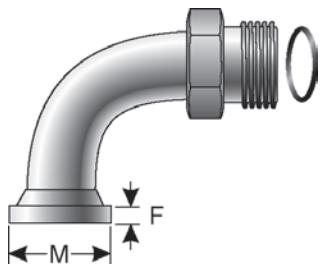

Part No.	Descr.	Prod. No.	M		F	
			"	mm	"	mm
G60925-1212	12FL5K-12MFFOR90	7253-13755	1 3/16-12	38.1	.27	6.9
G60925-1616	16FL5K-16MFFOR90	7253-13765	1 7/16-12	38.1	.32	8.1
G60925-2020	20FL4K-20MFFOR90	7253-13775	1 11/16-12	50.8	.32	8.1

NOTE: FL5K maximum working pressure is 5,000 psi; FL4K maximum working pressure is 4,000 psi.

### Code 62 O-Ring Flange Heavy to Male JIC 37° Flare - (6,000 psi)

No braze joints, solid one-piece construction for increased reliability.  
O-Ring not included. Must be ordered separately.

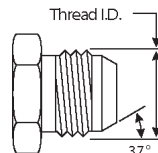
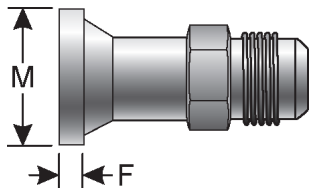

Part No.	Descr.	Prod. No.	M		F	
			"	mm	"	mm
G60930-1212	12FLH6K-12MJ	7253-13305	1 1/16-12	41.4	.35	8.9
G60930-1612	16FLH6K-12MJ	7253-12445	1 1/16-12	47.8	.38	9.7
G60930-1616	16FLH6K-16MJ	7253-13325	1 5/16-12	47.8	.38	9.7
G60930-1620	16FLH6K-20MJ	7253-12465	1 5/8-12	47.8	.38	9.7
G60930-2016	20FLH6K-16MJ	7253-12515	1 5/16-12	54.1	.41	10.4
G60930-2020	20FLH6K-20MJ	7253-13345	1 5/8-12	54.1	.41	10.4
G60930-2420	24FLH6K-20MJ	7253-13375	1 5/8-12	63.5	.50	12.7
G60930-2424	24FLH6K-24MJ	7253-13365	1 7/8-12	63.5	.50	12.7

- EQUIPMENT
- HOSE/CPLG. SELECTION
- G8K COUPLINGS
- GLOBALSPIRAL COUPLINGS
- STAINLESS STEEL SPIRAL
- MEGACRIMP COUPLINGS
- STAINLESS STEEL BRAID
- POWER CRIMP COUPLINGS
- FIELD ATTACHABLE G1 & G2 COUPLINGS
- FIELD ATTACHABLE C5 COUPLINGS
- C14 COUPLINGS
- GL COUPLINGS
- GLX COUPLINGS
- PCTS THERMOPLASTIC COUPLINGS
- POLARSEAL COUPLINGS (ACA)
- POLARSEAL II COUPLINGS (ACC)
- POLARSEAL II COUPLINGS (ACB)
- POWER STEERING
- ADAPTERS
- QUICK DISCONNECT COUPLERS
- BALL VALVES
- LIVE SWIVEL
- ASSEMBLY FABRICATION
- ACCESSORIES
- EQUIPMENT AND PARTS
- KITS
- AIR BRAKE HOSE ASSY
- BRASS



## Code 62 O-Ring Flange Heavy to Male JIC 37° Flare 45° - (6,000 psi)

No braze joints, solid one-piece construction for increased reliability.  
O-Ring not included. Must be ordered separately.

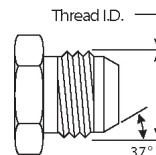
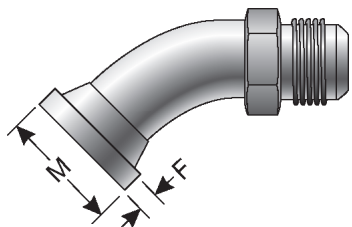

Part No.	Descr.	Prod. No.	M		F		
			"	mm	"	mm	
G60935-1212	12FLH6K-12MJ45	7253-13405	1 1/16-12	1.63	41.4	.35	8.9
G60935-1616	16FLH6K-16MJ45	7253-13425	1 5/16-12	1.88	47.8	.38	9.7
G60935-2020	20FLH6K-20MJ45	7253-13445	1 5/8-12	2.13	54.1	.41	10.4

## Code 62 O-Ring Flange Heavy to Male JIC 37° Flare 90° - (6,000 psi)

No braze joints, solid one-piece construction for increased reliability.  
O-Ring not included. Must be ordered separately.

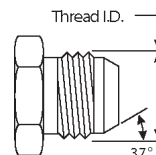
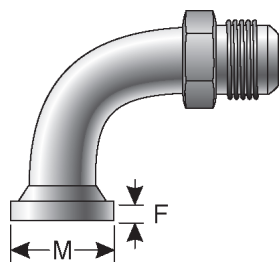

Part No.	Descr.	Prod. No.	M		F		
			"	mm	"	mm	
G60940-1212	12FLH6K-12MJ90	7253-13505	1 1/16-12	1.63	41.4	.35	8.9
G60940-1216	12FLH6K-16MJ90	7253-13515	1 5/16-12	1.63	41.4	.35	8.9
G60940-1612	16FLH6K-12MJ90	7253-12455	1 1/16-12	1.88	47.8	.38	9.7
G60940-1616	16FLH6K-16MJ90	7253-13535	1 5/16-12	1.88	47.8	.38	9.7
G60940-1620	16FLH6K-20MJ90	7253-13545	1 5/8-12	1.88	47.8	.38	9.7
G60940-2016	20FLH6K-16MJ90	7253-12525	1 5/16-12	2.13	54.1	.41	10.4
G60940-2020	20FLH6K-20MJ90	7253-13565	1 5/8-12	2.13	54.1	.41	10.4
G60940-2420	24FLH6K-20MJ90	7253-13575	1 5/8-12	2.50	63.5	.50	12.7

EQUIPMENT
HOSE/CPLG. SELECTION
G8K COUPLINGS
GLOBAL SPIRAL COUPLINGS
STAINLESS STEEL SPIRAL
MEGACRIMP COUPLINGS
STAINLESS STEEL BRAID
POWER CRIMP COUPLINGS
FIELD ATTACHABLE G1 & G2 COUPLINGS
FIELD ATTACHABLE C5 COUPLINGS
C14 COUPLINGS
GL COUPLINGS
GLX COUPLINGS
PCTS THERMOPLASTIC COUPLINGS
POLARSEAL COUPLINGS (ACA)
POLARSEAL II COUPLINGS (ACC)
POLARSEAL II COUPLINGS (ACB)
POWER STEERING
ADAPTERS
QUICK DISCONNECT COUPLERS
BALL VALVES
LIVE SWIVEL
ASSEMBLY FABRICATION
ACCESSORIES
EQUIPMENT AND PARTS
KITS
AIR BRAKE HOSE ASSY
BRASS



### Code 62 O-Ring Flange Heavy to Male Flat-Face O-Ring - (6,000 psi)

No braze joints, solid one-piece construction for increased reliability.  
O-Ring not included. Must be ordered separately.

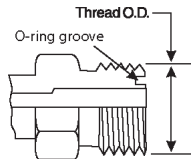
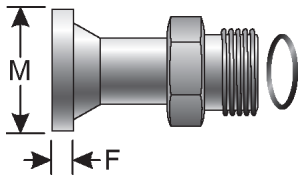

Part No.	Descr.	Prod. No.	M		F		
			"	mm	"	mm	
G60945-1212	12FLH6K-12MFFOR	7253-13605	1 3/16-12	1.63	41.4	.35	8.9
G60945-1616	16FLH6K-16MFFOR	7253-13615	1 7/16-12	1.88	47.8	.38	9.7
G60945-2020	20FLH6K-20MFFOR	7253-13625	1 11/16-12	2.13	54.1	.41	10.4

### Code 62 O-Ring Flange Heavy to Male Flat-Face O-Ring 45° - (6,000 psi)

No braze joints, solid one-piece construction for increased reliability.  
O-Ring not included. Must be ordered separately.

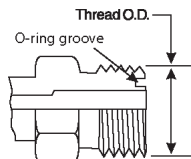
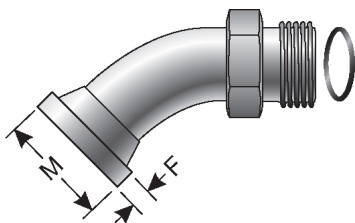

Part No.	Descr.	Prod. No.	M		F		
			"	mm	"	mm	
G60950-1212	12FLH6K-12MFFOR45	7253-13635	1 3/16-12	1.63	41.4	.35	8.9
G60950-1616	16FLH6K-16MFFOR45	7253-13645	1 7/16-12	1.88	47.8	.38	9.7
G60950-2020	20FLH6K-20MFFOR45	7253-13655	1 11/16-12	2.13	54.1	.41	10.4

### Code 62 O-Ring Flange Heavy to Male Flat-Face O-Ring 90° - (6,000 psi)

No braze joints, solid one-piece construction for increased reliability.  
O-Ring not included. Must be ordered separately.

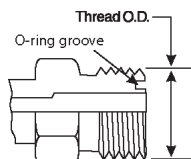
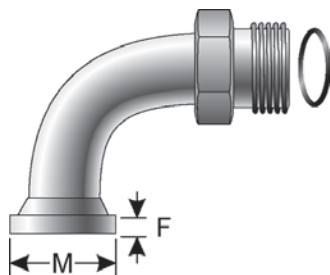

Part No.	Descr.	Prod. No.	M		F		
			"	mm	"	mm	
G60955-1212	12FLH6K-12MFFOR90	7253-13665	1 3/16-12	1.63	41.4	.35	8.9

- EQUIPMENT
- HOSE/CPLG. SELECTION
- G8K COUPLINGS
- GLOBALSPIRAL COUPLINGS
- STAINLESS STEEL SPIRAL
- MEGACRIMP COUPLINGS
- STAINLESS STEEL BRAID
- POWER CRIMP COUPLINGS
- FIELD ATTACHABLE G1 & G2 COUPLINGS
- FIELD ATTACHABLE C5 COUPLINGS
- C14 COUPLINGS
- GL COUPLINGS
- GLX COUPLINGS
- PCTS THERMOPLASTIC COUPLINGS
- POLARSEAL COUPLINGS (ACA)
- POLARSEAL II COUPLINGS (ACC)
- POLARSEAL II COUPLINGS (ACB)
- POWER STEERING
- ADAPTERS
- QUICK DISCONNECT COUPLERS
- BALL VALVES
- LIVE SWIVEL
- ASSEMBLY FABRICATION
- ACCESSORIES
- EQUIPMENT AND PARTS
- KITS
- AIR BRAKE HOSE ASSY
- BRASS



## Code 62 O-Ring Flange Heavy to Male Flat-Face O-Ring 90° - (6,000 psi) - Continued

Part No.	Descr.	Prod. No.		M		F	
			"	"	mm	"	mm
G60955-1612	16FLH6K-12MFFOR90	7253-13465	1 3/16-12	1.88	47.8	.38	9.7
G60955-1616	16FLH6K-16MFFOR90	7253-13675	1 7/16-12	1.88	47.8	.38	9.7
G60955-2020	20FLH6K-20MFFOR90	7253-13685	1 11/16-12	2.13	54.1	.41	10.4

EQUIPMENT
HOSE/CPLG. SELECTION
G8K COUPLINGS
GLOBAL SPIRAL COUPLINGS
STAINLESS STEEL SPIRAL
MEGACRIMP COUPLINGS
STAINLESS STEEL BRAID
POWER CRIMP COUPLINGS
FIELD ATTACHABLE G1 & G2 COUPLINGS
FIELD ATTACHABLE C5 COUPLINGS
C14 COUPLINGS
GL COUPLINGS
GLX COUPLINGS
PCTS THERMOPLASTIC COUPLINGS
POLARSEAL COUPLINGS (ACA)
POLARSEAL II COUPLINGS (ACC)
POLARSEAL II COUPLINGS (ACB)
POWER STEERING
<b>ADAPTERS</b>
QUICK DISCONNECT COUPLERS
BALL VALVES
LIVE SWIVEL
ASSEMBLY FABRICATION
ACCESSORIES
EQUIPMENT AND PARTS
KITS
AIR BRAKE HOSE ASSY
BRASS





### Male British Standard Pipe Tapered Thread to Male JIC 37° Flare

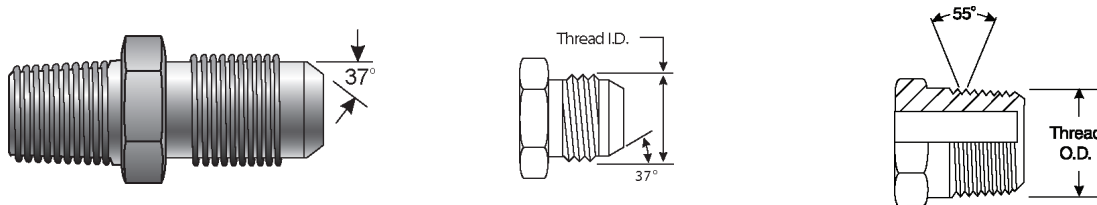

Part No.	Descr.	Prod. No.		
			"	"
G62150-0204	2MBSPT-4MJ	7253-14255	1/8-28	7/16-20
G62150-0205	2MBSPT-5MJ	7253-60005	1/8-28	1/2-20
G62150-0206	2MBSPT-6MJ	7253-60015	1/8-28	9/16-18
G62150-0404	4MBSPT-4MJ	7253-14265	1/4-19	7/16-20
G62150-0405	4MBSPT-5MJ	7253-60025	1/4-19	1/2-20
G62150-0406	4MBSPT-6MJ	7253-60035	1/4-19	9/16-18
G62150-0408	4MBSPT-8MJ	7253-60045	1/4-19	3/4-16
G62150-0604	6MBSPT-4MJ	7253-60055	3/8-19	7/16-20
G62150-0605	6MBSPT-5MJ	7253-60065	3/8-19	1/2-20
G62150-0606	6MBSPT-6MJ	7253-14275	3/8-19	9/16-18
G62150-0608	6MBSPT-8MJ	7253-60075	3/8-19	3/4-16
G62150-0610	6MBSPT-10MJ	7253-60085	3/8-19	7/8-14
G62150-0806	8MBSPT-6MJ	7253-60095	1/2-14	9/16-18
G62150-0808	8MBSPT-8MJ	7253-14285	1/2-14	3/4-16
G62150-0810	8MBSPT-10MJ	7253-14295	1/2-14	7/8-14
G62150-0812	8MBSPT-12MJ	7253-60105	1/2-14	1 1/16-12
G62150-1208	12MBSPT-8MJ	7253-60115	3/4-14	3/4-16
G62150-1210	12MBSPT-10MJ	7253-60125	3/4-14	7/8-14
G62150-1212	12MBSPT-12MJ	7253-14305	3/4-14	1 1/16-12
G62150-1214	12MBSPT-14MJ	7253-60135	3/4-14	1 3/16-12
G62150-1216	12MBSPT-16MJ	7253-60145	3/4-14	1 5/16-12
G62150-1612	16MBSPT-12MJ	7253-60155	1-11	1 1/16-12
G62150-1616	16MBSPT-16MJ	7253-14315	1-11	1 5/16-12
G62150-1620	16MBSPT-20MJ	7253-60165	1-11	1 5/8-12
G62150-2016	20MBSPT-16MJ	7253-60175	1 1/4-11	1 5/16-12
G62150-2020	20MBSPT-20MJ	7253-60185	1 1/4-11	1 5/8-12
G62150-2424	24MBSPT-24MJ	7253-60195	1 1/2-11	1 7/8-12
G62150-3232	32MBSPT-32MJ	7253-60205	2-11	2 1/2-12

### Male British Standard Pipe Tapered Thread to Male JIC 37° Flare - 45°

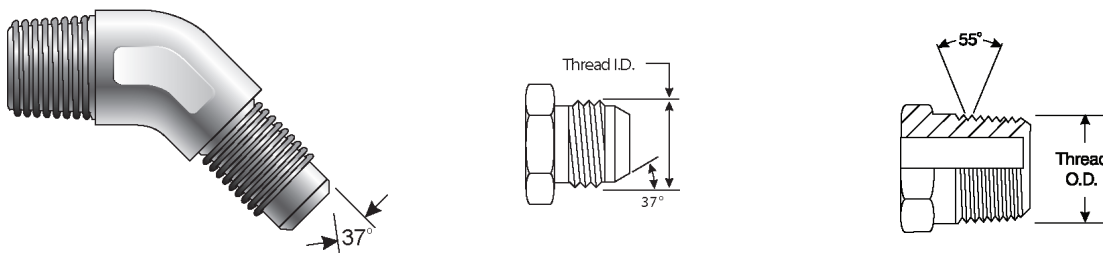

Part No.	Descr.	Prod. No.		
			"	"
G62153-0204	2MBSPT-4MJ45	7253-60215	1/8-28	7/16-20

- EQUIPMENT
- HOSE/CPLG. SELECTION
- G8K COUPLINGS
- GLOBALSPIRAL COUPLINGS
- STAINLESS STEEL SPIRAL
- MEGACRIMP COUPLINGS
- STAINLESS STEEL BRAID
- POWER CRIMP COUPLINGS
- FIELD ATTACHABLE G1 & G2 COUPLINGS
- FIELD ATTACHABLE C5 COUPLINGS
- C14 COUPLINGS
- GL COUPLINGS
- GLX COUPLINGS
- PCTS THERMOPLASTIC COUPLINGS
- POLARSEAL COUPLINGS (ACA)
- POLARSEAL II COUPLINGS (ACC)
- POLARSEAL II COUPLINGS (ACB)
- POWER STEERING
- ADAPTERS
- QUICK DISCONNECT COUPLERS
- BALL VALVES
- LIVE SWIVEL
- ASSEMBLY FABRICATION
- ACCESSORIES
- EQUIPMENT AND PARTS
- KITS
- AIR BRAKE HOSE ASSY
- BRASS



Male British Standard Pipe Tapered Thread to Male JIC 37° Flare - 45° - Continued

Part No.	Descr.	Prod. No.		
			"	"
G62153-0404	4MBSPT-4MJ45	7253-60225	1/4-19	7/16-20
G62153-0406	4MBSPT-6MJ45	7253-60235	1/4-19	9/16-18
G62153-0606	6MBSPT-6MJ45	7253-60245	3/8-19	9/16-18
G62153-0608	6MBSPT-8MJ45	7253-60255	3/8-19	3/4-16
G62153-0808	8MBSPT-8MJ45	7253-60265	1/2-14	3/4-16
G62153-0810	8MBSPT-10MJ45	7253-60275	1/2-14	7/8-14
G62153-1212	12MBSPT-12MJ45	7253-60285	3/4-14	1 1/16-12
G62153-1216	12MBSPT-16MJ45	7253-60295	3/4-14	1 5/16-12
G62153-1616	16MBSPT-16MJ45	7253-60305	1-11	1 5/16-12

Male British Standard Pipe Tapered Thread to Male JIC 37° Flare - 90°

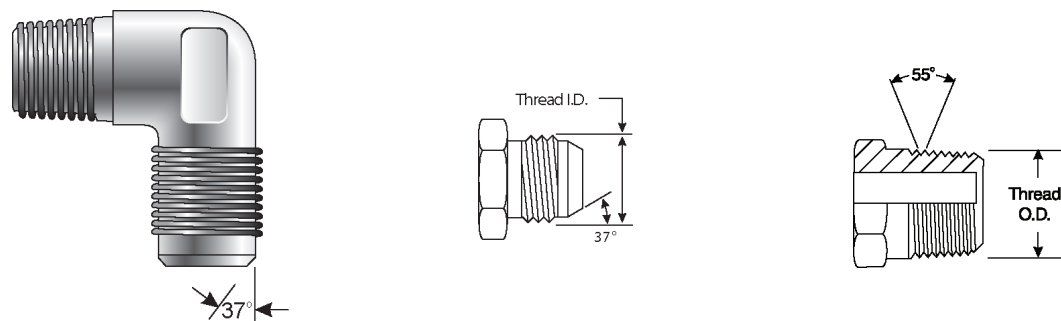



Part No.	Descr.	Prod. No.		
			"	"
G62155-0204	2MBSPT-4MJ90	7253-60315	1/8-28	7/16-20
G62155-0404	4MBSPT-4MJ90	7253-60325	1/4-19	7/16-20
G62155-0405	4MBSPT-5MJ90	7253-60335	1/4-19	1/2-20
G62155-0406	4MBSPT-6MJ90	7253-60345	1/4-19	9/16-18
G62155-0606	6MBSPT-6MJ90	7253-60355	3/8-19	9/16-18
G62155-0608	6MBSPT-8MJ90	7253-60365	3/8-19	3/4-16
G62155-0806	8MBSPT-6MJ90	7253-60375	1/2-14	9/16-18
G62155-0808	8MBSPT-8MJ90	7253-60385	1/2-14	3/4-16
G62155-0810	8MBSPT-10MJ90	7253-60395	1/2-14	7/8-14
G62155-0812	8MBSPT-12MJ90	7253-60405	1/2-14	1 1/16-12
G62155-1212	12MBSPT-12MJ90	7253-60415	3/4-14	1 1/16-12
G62155-1216	12MBSPT-16MJ90	7253-60425	3/4-14	1 5/16-12
G62155-1616	16MBSPT-16MJ90	7253-60435	1-11	1 5/16-12
G62155-2020	20MBSPT-20MJ90	7253-60445	1 1/4-11	1 5/8-12
G62155-2424	24MBSPT-24MJ90	7253-60455	1 1/2-11	1 7/8-12

EQUIPMENT
HOSE/CPLG. SELECTION
G8K COUPLINGS
GLOBAL SPIRAL COUPLINGS
STAINLESS STEEL SPIRAL
MEGACRIMP COUPLINGS
STAINLESS STEEL BRAID
POWER CRIMP COUPLINGS
FIELD ATTACHABLE G1 & G2 COUPLINGS
FIELD ATTACHABLE C5 COUPLINGS
C14 COUPLINGS
GL COUPLINGS
GLX COUPLINGS
PCTS THERMOPLASTIC COUPLINGS
POLARSEAL COUPLINGS (ACA)
POLARSEAL II COUPLINGS (ACC)
POLARSEAL II COUPLINGS (ACB)
POWER STEERING
ADAPTERS
QUICK DISCONNECT COUPLERS
BALL VALVES
LIVE SWIVEL
ASSEMBLY FABRICATION
ACCESSORIES
EQUIPMENT AND PARTS
KITS
AIR BRAKE HOSE ASSY
BRASS



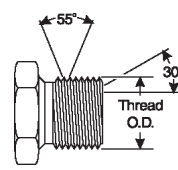
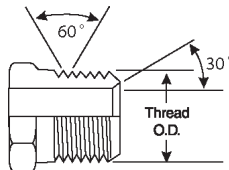
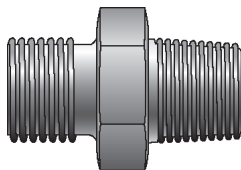

### Male British Standard Pipe Parallel to Male Pipe NPTF

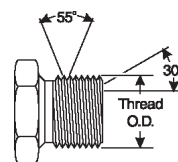
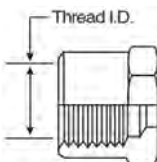
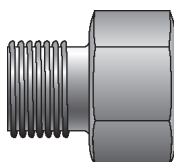

Part No.	Descr.	Prod. No.		
			"	"
G62200-0202	2MBSPP-2MP	7253-60475	1/8-28	1/8-27
G62200-0204	2MBSPP-4MP	7253-60485	1/8-28	1/4-18
G62200-0402	4MBSPP-2MP	7253-60495	1/4-19	1/8-27
G62200-0404	4MBSPP-4MP	7253-15075	1/4-19	1/4-18
G62200-0406	4MBSPP-6MP	7253-60505	1/4-19	3/8-18
G62200-0408	4MBSPP-8MP	7253-60515	1/4-19	1/2-14
G62200-0602	6MBSPP-2MP	7253-60525	3/8-19	1/8-27
G62200-0604	6MBSPP-4MP	7253-60535	3/8-19	1/4-18
G62200-0606	6MBSPP-6MP	7253-15085	3/8-19	3/8-18
G62200-0608	6MBSPP-8MP	7253-60545	3/8-19	1/2-14
G62200-0612	6MBSPP-12MP	7253-60555	3/8-19	3/4-14
G62200-0616	6MBSPP-16MP	7253-60565	3/8-19	1-11 1/2
G62200-0804	8MBSPP-4MP	7253-60575	1/2-14	1/4-18
G62200-0806	8MBSPP-6MP	7253-60585	1/2-14	3/8-18
G62200-0808	8MBSPP-8MP	7253-15095	1/2-14	1/2-14
G62200-0812	8MBSPP-12MP	7253-60595	1/2-14	3/4-14
G62200-0816	8MBSPP-16MP	7253-60605	1/2-14	1-11 1/2
G62200-1008	10MBSPP-8MP	7253-60615	5/8-14	1/2-14
G62200-1012	10MBSPP-12MP	7253-60625	5/8-14	3/4-14
G62200-1208	12MBSPP-8MP	7253-60635	3/4-14	1/2-14
G62200-1212	12MBSPP-12MP	7253-15105	3/4-14	3/4-14
G62200-1216	12MBSPP-16MP	7253-60645	3/4-14	1-11 1/2
G62200-1220	12MBSPP-20MP	7253-60655	3/4-14	1 1/4-11 1/2
G62200-1612	16MBSPP-12MP	7253-60665	1-11	3/4-14
G62200-1616	16MBSPP-16MP	7253-15115	1-11	1-11 1/2
G62200-1620	16MBSPP-20MP	7253-60675	1-11	1 1/4-11 1/2
G62200-2016	20MBSPP-16MP	7253-60685	1 1/4-11	1-11 1/2
G62200-2020	20MBSPP-20MP	7253-60695	1 1/4-11	1 1/4-11 1/2
G62200-2024	20MBSPP-24MP	7253-60705	1 1/4-11	1 1/2-11 1/2
G62200-2420	24MBSPP-20MP	7253-60715	1 1/2-11	1 1/4-11 1/2
G62200-2424	24MBSPP-24MP	7253-60725	1 1/2-11	1 1/2-11 1/2
G62200-3232	32MBSPP-32MP	7253-60735	2-11	2-11 1/2

### Male British Standard Pipe Parallel to Female Pipe NPTF



Part No.	Descr.	Prod. No.		
			"	"
G62220-0202	2MBSPP-2FP	7253-60745	1/8-28	1/8-27

- EQUIPMENT
- HOSE/CPLG. SELECTION
- G8K COUPLINGS
- GLOBAL SPIRAL COUPLINGS
- STAINLESS STEEL SPIRAL
- MEGACRIMP COUPLINGS
- STAINLESS STEEL BRAID
- POWER CRIMP COUPLINGS
- FIELD ATTACHABLE G1 & G2 COUPLINGS
- FIELD ATTACHABLE C5 COUPLINGS
- C14 COUPLINGS
- GL COUPLINGS
- GLX COUPLINGS
- PCTS THERMOPLASTIC COUPLINGS
- POLARSEAL COUPLINGS (ACA)
- POLARSEAL II COUPLINGS (ACC)
- POLARSEAL II COUPLINGS (ACB)
- POWER STEERING
- ADAPTERS
- QUICK DISCONNECT COUPLERS
- BALL VALVES
- LIVE SWIVEL
- ASSEMBLY FABRICATION
- ACCESSORIES
- EQUIPMENT AND PARTS
- KITS
- AIR BRAKE HOSE ASSY
- BRASS





Male British Standard Pipe Parallel to Female Pipe NPTF - Continued

EQUIPMENT
HOSE/CPLG. SELECTION
G8K COUPLINGS
GLOBAL SPIRAL COUPLINGS
STAINLESS STEEL SPIRAL
MEGACRIMP COUPLINGS
STAINLESS STEEL BRAID
POWER CRIMP COUPLINGS
FIELD ATTACHABLE G1 & G2 COUPLINGS
FIELD ATTACHABLE C5 COUPLINGS
C14 COUPLINGS
GL COUPLINGS
GLX COUPLINGS
PCTS THERMOPLASTIC COUPLINGS
POLARSEAL COUPLINGS (ACA)
POLARSEAL II COUPLINGS (ACC)
POLARSEAL II COUPLINGS (ACB)
POWER STEERING
ADAPTERS
QUICK DISCONNECT COUPLERS
BALL VALVES
LIVE SWIVEL
ASSEMBLY FABRICATION
ACCESSORIES
EQUIPMENT AND PARTS
KITS
AIR BRAKE HOSE ASSY
BRASS

Part No.	Descr.	Prod. No.		
			"	"
G62220-0204	2MBSPP-4FP	7253-60755	1/8-28	1/4-18
G62220-0402	4MBSPP-2FP	7253-60765	1/4-19	1/8-27
G62220-0404	4MBSPP-4FP	7253-60775	1/4-19	1/4-18
G62220-0406	4MBSPP-6FP	7253-60785	1/4-19	3/8-18
G62220-0602	6MBSPP-2FP	7253-60795	3/8-19	1/8-27
G62220-0604	6MBSPP-4FP	7253-60805	3/8-19	1/4-18
G62220-0606	6MBSPP-6FP	7253-60815	3/8-19	3/8-18
G62220-0804	8MBSPP-4FP	7253-60825	1/2-14	1/4-18
G62220-0806	8MBSPP-6FP	7253-60835	1/2-14	3/8-18
G62220-0808	8MBSPP-8FP	7253-60845	1/2-14	1/2-14
G62220-1208	12MBSPP-8FP	7253-60855	3/4-14	1/2-14
G62220-1212	12MBSPP-12FP	7253-60865	3/4-14	3/4-14
G62220-1616	16MBSPP-16FP	7253-60875	1-11	1-11 1/2
G62220-2016	20MBSPP-16FP	7253-60885	1 1/4-11	1-11 1/2
G62220-2020	20MBSPP-20FP	7253-60895	1 1/4-11	1 1/4-11 1/2
G62220-2420	24MBSPP-20FP	7253-60905	1 1/2-11	1 1/4-11 1/2
G62220-2424	24MBSPP-24FP	7253-60915	1 1/2-11	1 1/2-11 1/2
G62220-3232	32MBSPP-32FP	7253-60925	2-11	2-11 1/2

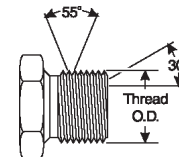
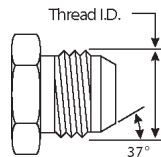
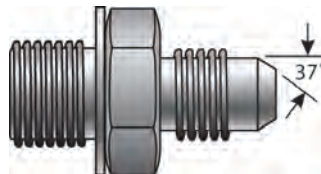
Male British Standard Pipe Parallel to Male JIC 37° Flare



Part No.	Descr.	Prod. No.		
			"	"
G62300-0204	2MBSPP-4MJ	7253-60935	1/8-28	7/16-20
G62300-0205	2MBSPP-5MJ	7253-60945	1/8-28	1/2-20
G62300-0206	2MBSPP-6MJ	7253-60955	1/8-28	9/16-18
G62300-0404	4MBSPP-4MJ	7253-15015	1/4-19	7/16-20
G62300-0405	4MBSPP-5MJ	7253-60965	1/4-19	1/2-20
G62300-0406	4MBSPP-6MJ	7253-60975	1/4-19	9/16-18
G62300-0408	4MBSPP-8MJ	7253-60985	1/4-19	3/4-16
G62300-0604	6MBSPP-4MJ	7253-60995	3/8-19	7/16-20
G62300-0605	6MBSPP-5MJ	7253-61005	3/8-19	1/2-20
G62300-0606	6MBSPP-6MJ	7253-15025	3/8-19	9/16-18
G62300-0608	6MBSPP-8MJ	7253-61015	3/8-19	3/4-16
G62300-0806	8MBSPP-6MJ	7253-61025	1/2-14	9/16-18
G62300-0808	8MBSPP-8MJ	7253-15035	1/2-14	3/4-16
G62300-0810	8MBSPP-10MJ	7253-61035	1/2-14	7/8-14
G62300-0812	8MBSPP-12MJ	7253-61045	1/2-14	1 1/16-12
G62300-1008	10MBSPP-8MJ	7253-61055	5/8-14	3/4-16
G62300-1010	10MBSPP-10MJ	7253-15045	5/8-14	7/8-14
G62300-1012	10MBSPP-12MJ	7253-61065	5/8-14	1 1/16-12
G62300-1208	12MBSPP-8MJ	7253-61075	3/4-14	3/4-16
G62300-1210	12MBSPP-10MJ	7253-61085	3/4-14	7/8-14
G62300-1212	12MBSPP-12MJ	7253-15055	3/4-14	1 1/16-12
G62300-1214	12MBSPP-14MJ	7253-61095	3/4-14	1 3/16-12



Male British Standard Pipe Parallel to Male JIC 37° Flare - Continued

Part No.	Descr.	Prod. No.		
			"	"
G62300-1216	12MBSPP-16MJ	7253-61105	3/4-14	1 5/16-12
G62300-1612	16MBSPP-12MJ	7253-61115	1-11	1 1/16-12
G62300-1614	16MBSPP-14MJ	7253-61125	1-11	1 3/16-12
G62300-1616	16MBSPP-16MJ	7253-15065	1-11	1 5/16-12
G62300-1620	16MBSPP-20MJ	7253-61135	1-11	1 5/8-12
G62300-2016	20MBSPP-16MJ	7253-61145	1 1/4-11	1 5/16-12
G62300-2020	20MBSPP-20MJ	7253-61155	1 1/4-11	1 5/8-12
G62300-2024	20MBSPP-24MJ	7253-61165	1 1/4-11	1 7/8-12
G62300-2420	24MBSPP-20MJ	7253-61175	1 1/2-11	1 5/8-12
G62300-2424	24MBSPP-24MJ	7253-61185	1 1/2-11	1 7/8-12
G62300-3232	32MBSPP-32MJ	7253-61195	2-11	2 1/2-12

Male British Standard Pipe Parallel to Male JIC 37° Flare - 45°

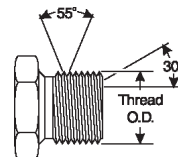
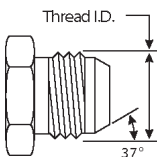
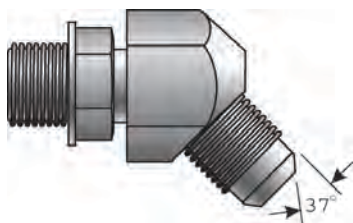

Part No.	Descr.	Prod. No.		
			"	"
G62305-0204	2MBSPP-4MJ45	7253-61205	1/8-28	7/16-20
G62305-0404	4MBSPP-4MJ45	7253-61215	1/4-19	7/16-20
G62305-0406	4MBSPP-6MJ45	7253-61225	1/4-19	9/16-18
G62305-0606	6MBSPP-6MJ45	7253-61235	3/8-19	9/16-18
G62305-0608	6MBSPP-8MJ45	7253-61245	3/8-19	3/4-16
G62305-0808	8MBSPP-8MJ45	7253-61255	1/2-14	3/4-16
G62305-0810	8MBSPP-10MJ45	7253-61265	1/2-14	7/8-14
G62305-0812	8MBSPP-12MJ45	7253-61275	1/2-14	1 1/16-12
G62305-1212	12MBSPP-12MJ45	7253-61285	3/4-14	1 1/16-12
G62305-1616	16MBSPP-16MJ45	7253-61295	1-11	1 5/16-12

- EQUIPMENT
- HOSE/CPLG. SELECTION
- G8K COUPLINGS
- GLOBAL SPIRAL COUPLINGS
- STAINLESS STEEL SPIRAL
- MEGACRIMP COUPLINGS
- STAINLESS STEEL BRAID
- POWER CRIMP COUPLINGS
- FIELD ATTACHABLE G1 & G2 COUPLINGS
- FIELD ATTACHABLE C5 COUPLINGS
- C14 COUPLINGS
- GL COUPLINGS
- GLX COUPLINGS
- PCTS THERMOPLASTIC COUPLINGS
- POLARSEAL COUPLINGS (ACA)
- POLARSEAL II COUPLINGS (ACC)
- POLARSEAL II COUPLINGS (ACB)
- POWER STEERING
- ADAPTERS
- QUICK DISCONNECT COUPLERS
- BALL VALVES
- LIVE SWIVEL
- ASSEMBLY FABRICATION
- ACCESSORIES
- EQUIPMENT AND PARTS
- KITS
- AIR BRAKE HOSE ASSY
- BRASS



### Male British Standard Pipe Parallel to Male JIC 37° Flare - 90°

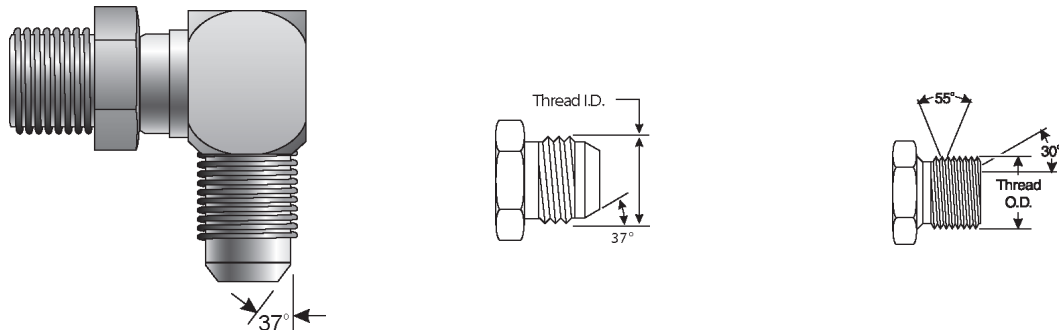

Part No.	Descr.	Prod. No.		
			"	"
G62310-0204	2MBSPP-4MJ90	7253-61305	1/8-28	7/16-20
G62310-0404	4MBSPP-4MJ90	7253-61315	1/4-19	7/16-20
G62310-0405	4MBSPP-5MJ90	7253-61325	1/4-19	1/2-20
G62310-0406	4MBSPP-6MJ90	7253-61335	1/4-19	9/16-18
G62310-0408	4MBSPP-8MJ90	7253-61345	1/4-19	3/4-16
G62310-0604	6MBSPP-4MJ90	7253-61355	3/8-19	7/16-20
G62310-0605	6MBSPP-5MJ90	7253-61365	3/8-19	1/2-20
G62310-0608	6MBSPP-8MJ90	7253-61385	3/8-19	3/4-16
G62310-0806	8MBSPP-6MJ90	7253-61395	1/2-14	9/16-18
G62310-0810	8MBSPP-10MJ90	7253-61415	1/2-14	7/8-14
G62310-0812	8MBSPP-12MJ90	7253-61425	1/2-14	1 1/16-12
G62310-1208	12MBSPP-8MJ90	7253-61435	3/4-14	3/4-16
G62310-1210	12MBSPP-10MJ90	7253-61445	3/4-14	7/8-14
G62310-1216	12MBSPP-16MJ90	7253-61465	3/4-14	1 5/16-12
G62310-1612	16MBSPP-12MJ90	7253-61475	1-11	1 1/16-12
G62310-1616	16MBSPP-16MJ90	7253-61485	1-11	1 5/16-12
G62310-1620	16MBSPP-20MJ90	7253-61495	1-11	1 5/8-12
G62310-2016	20MBSPP-16MJ90	7253-61505	1 1/4-11	1 5/16-12
G62310-2020	20MBSPP-20MJ90	7253-61515	1 1/4-11	1 5/8-12
G62310-2424	24MBSPP-24MJ90	7253-61525	1 1/2-11	1 7/8-12

### Male British Standard Pipe Parallel to Female JIC 37° Flare Swivel

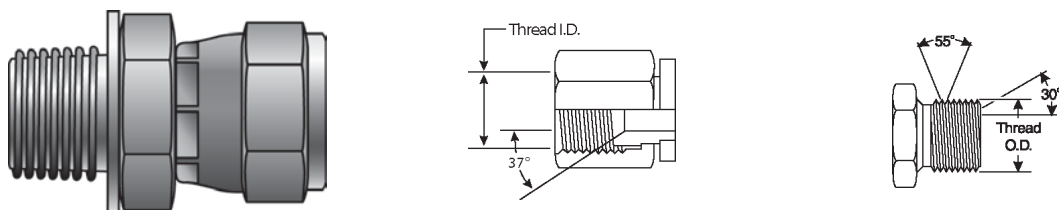

Part No.	Descr.	Prod. No.		
			"	"
G62320-0204	2MBSPP-4FJX	7253-61535	1/8-28	7/16-20
G62320-0404	4MBSPP-4FJX	7253-15125	1/4-19	7/16-20
G62320-0405	4MBSPP-5FJX	7253-61545	1/4-19	1/2-20
G62320-0406	4MBSPP-6FJX	7253-61555	1/4-19	9/16-18
G62320-0604	6MBSPP-4FJX	7253-61565	3/8-19	7/16-20
G62320-0606	6MBSPP-6FJX	7253-15135	3/8-19	9/16-18



Male British Standard Pipe Parallel to Female JIC 37° Flare Swivel - Continued

Part No.	Descr.	Prod. No.		
			"	"
G62320-0608	6MBSPP-8FJX	7253-61575	3/8-19	3/4-16
G62320-0804	8MBSPP-4FJX	7253-61585	1/2-14	7/16-20
G62320-0806	8MBSPP-6FJX	7253-61595	1/2-14	9/16-18
G62320-0808	8MBSPP-8FJX	7253-15145	1/2-14	3/4-16
G62320-0810	8MBSPP-10FJX	7253-61605	1/2-14	7/8-14
G62320-0812	8MBSPP-12FJX	7253-61615	1/2-14	1 1/16-12
G62320-1008	10MBSPP-8FJX	7253-61625	5/8-14	3/4-16
G62320-1010	10MBSPP-10FJX	7253-15155	5/8-14	7/8-14
G62320-1208	12MBSPP-8FJX	7253-61635	3/4-14	3/4-16
G62320-1212	12MBSPP-12FJX	7253-15165	3/4-14	1 1/16-12
G62320-1216	12MBSPP-16FJX	7253-61645	3/4-14	1 5/16-12
G62320-1616	16MBSPP-16FJX	7253-15175	1-11	1 5/16-12
G62320-1620	16MBSPP-20FJX	7253-61655	1-11	1 5/8-12
G62320-2016	20MBSPP-16FJX	7253-61665	1 1/4-11	1 5/16-12
G62320-2020	20MBSPP-20FJX	7253-61675	1 1/4-11	1 5/8-12
G62320-2424	24MBSPP-24FJX	7253-61685	1 1/2-11	1 7/8-12
G62320-3232	32MBSPP-32FJX	7253-61695	2-11	2 1/2-12

Male British Standard Pipe Parallel with O-Ring to Male JIC 37° Flare

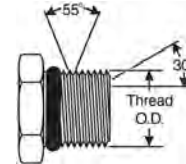
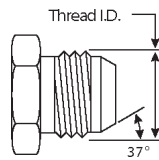
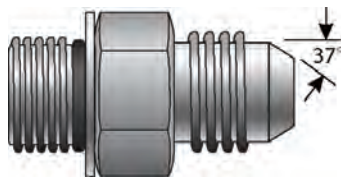

Part No.	Descr.	Prod. No.		
			"	"
G62450-0204	2MBSPPOR-4MJ	7253-14005	1/8-28	7/16-20
G62450-0404	4MBSPPOR-4MJ	7253-14015	1/4-19	7/16-20
G62450-0405	4MBSPPOR-5MJ	7253-61705	1/4-19	1/2-20
G62450-0406	4MBSPPOR-6MJ	7253-14025	1/4-19	9/16-18
G62450-0604	6MBSPPOR-4MJ	7253-14035	3/8-19	7/16-20
G62450-0605	6MBSPPOR-5MJ	7253-61715	3/8-19	1/2-20
G62450-0606	6MBSPPOR-6MJ	7253-14045	3/8-19	9/16-18
G62450-0608	6MBSPPOR-8MJ	7253-14055	3/8-19	3/4-16
G62450-0806	8MBSPPOR-6MJ	7253-14075	1/2-14	9/16-18
G62450-0808	8MBSPPOR-8MJ	7253-14085	1/2-14	3/4-16
G62450-0810	8MBSPPOR-10MJ	7253-61725	1/2-14	7/8-14
G62450-0812	8MBSPPOR-12MJ	7253-14605	1/2-14	1 1/16-12
G62450-1208	12MBSPPOR-8MJ	7253-61735	3/4-14	3/4-16
G62450-1210	12MBSPPOR-10MJ	7253-61745	3/4-14	7/8-14
G62450-1212	12MBSPPOR-12MJ	7253-14095	3/4-14	1 1/16-12
G62450-1216	12MBSPPOR-16MJ	7253-61755	3/4-14	1 5/16-12
G62450-1612	16MBSPPOR-12MJ	7253-61765	1-11	1 1/16-12
G62450-1616	16MBSPPOR-16MJ	7253-14105	1-11	1 5/16-12
G62450-2020	20MBSPPOR-20MJ	7253-14115	1 1/4-11	1 5/8-12
G62450-2024	20MBSPPOR-24MJ	7253-61775	1 1/4-11	1 7/8-12
G62450-2424	24MBSPPOR-24MJ	7253-61785	1 1/2-11	1 7/8-12

- EQUIPMENT
- HOSE/CPLG. SELECTION
- G8K COUPLINGS
- GLOBAL SPIRAL COUPLINGS
- STAINLESS STEEL SPIRAL
- MEGACRIMP COUPLINGS
- STAINLESS STEEL BRAID
- POWER CRIMP COUPLINGS
- FIELD ATTACHABLE G1 & G2 COUPLINGS
- FIELD ATTACHABLE C5 COUPLINGS
- C14 COUPLINGS
- GL COUPLINGS
- GLX COUPLINGS
- PCTS THERMOPLASTIC COUPLINGS
- POLARSEAL COUPLINGS (ACA)
- POLARSEAL II COUPLINGS (ACC)
- POLARSEAL II COUPLINGS (ACB)
- POWER STEERING
- ADAPTERS
- QUICK DISCONNECT COUPLERS
- BALL VALVES
- LIVE SWIVEL
- ASSEMBLY FABRICATION
- ACCESSORIES
- EQUIPMENT AND PARTS
- KITS
- AIR BRAKE HOSE ASSY
- BRASS





## Male British Standard Pipe Parallel with O-Ring to Male JIC 37° Flare - 90°

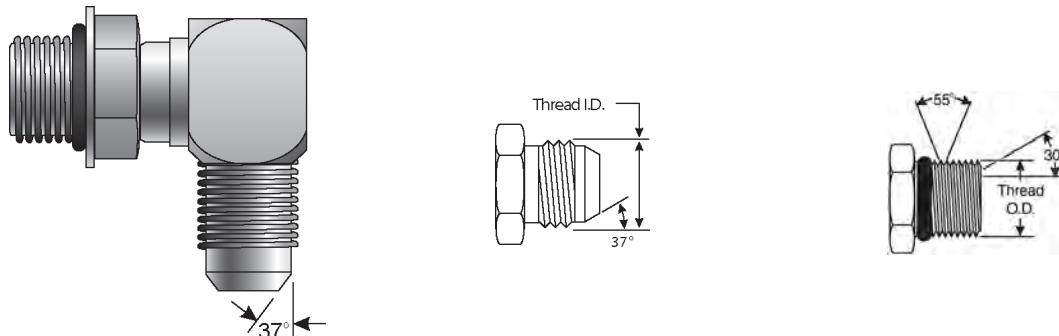

Part No.	Descr.	Prod. No.		
			"	"
G62460-0606	6MBSPPOR-6MJ90	7253-14505	3/8-19	9/16-18
G62460-0808	8MBSPPOR-8MJ90	7253-14515	1/2-14	3/4-16
G62460-1212	12MBSPPOR-12MJ90	7253-14525	3/4-14	1 1/16-12

## Male British Standard Pipe Parallel with O-Ring to Male Flat-Face O-Ring

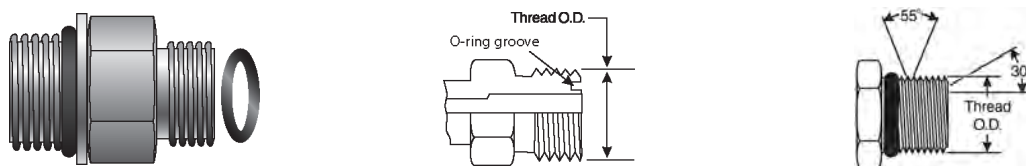

Part No.	Descr.	Prod. No.		
			"	"
G62470-0204	2MBSPPOR-4MFFOR	7253-61795	1/8-28	9/16-18
G62470-0404	4MBSPPOR-4MFFOR	7253-61805	1/4-19	9/16-18
G62470-0406	4MBSPPOR-6MFFOR	7253-61815	1/4-19	11/16-16
G62470-0606	6MBSPPOR-6MFFOR	7253-61825	3/8-19	11/16-16
G62470-0608	6MBSPPOR-8MFFOR	7253-61835	3/8-19	13/16-16
G62470-0806	8MBSPPOR-6MFFOR	7253-61845	1/2-14	11/16-16
G62470-0808	8MBSPPOR-8MFFOR	7253-61855	1/2-14	13/16-16
G62470-0810	8MBSPPOR-10MFFOR	7253-61865	1/2-14	1-14
G62470-1212	12MBSPPOR-12MFFOR	7253-61875	3/4-14	1 3/16-12
G62470-1216	12MBSPPOR-16MFFOR	7253-61885	3/4-14	1 7/16-12
G62470-1612	16MBSPPOR-12MFFOR	7253-61895	1-11	1 3/16-12
G62470-1616	16MBSPPOR-16MFFOR	7253-61905	1-11	1 7/16-12
G62470-2020	20MBSPPOR-20MFFOR	7253-61915	1 1/4-11	1 11/16-12
G62470-2424	24MBSPPOR-24MFFOR	7253-61925	1 1/2-11	2-12

EQUIPMENT
HOSE/CPLG. SELECTION
G8K COUPLINGS
GLOBAL SPIRAL COUPLINGS
STAINLESS STEEL SPIRAL
MEGACRIMP COUPLINGS
STAINLESS STEEL BRAID
POWER CRIMP COUPLINGS
FIELD ATTACHABLE G1 & G2 COUPLINGS
FIELD ATTACHABLE C5 COUPLINGS
C14 COUPLINGS
GL COUPLINGS
GLX COUPLINGS
PCTS THERMOPLASTIC COUPLINGS
POLARSEAL COUPLINGS (ACA)
POLARSEAL II COUPLINGS (ACC)
POLARSEAL II COUPLINGS (ACB)
POWER STEERING
ADAPTERS
QUICK DISCONNECT COUPLERS
BALL VALVES
LIVE SWIVEL
ASSEMBLY FABRICATION
ACCESSORIES
EQUIPMENT AND PARTS
KITS
AIR BRAKE HOSE ASSY
BRASS





## Male British Standard Pipe Parallel with O-Ring to Male Flat-Face O-Ring - Long

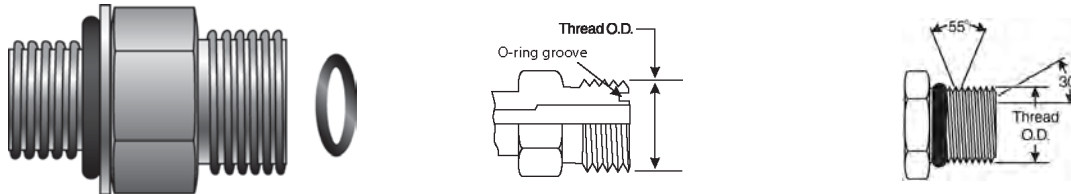

Part No.	Descr.	Prod. No.		
			"	"
G62471-0608	6MBSPPOR-8MFFORL	7253-61935	3/8-19	13/16-16
G62471-0808	8MBSPPOR-8MFFORL	7253-61945	1/2-14	13/16-16
G62471-0810	8MBSPPOR-10MFFORL	7253-61955	1/2-14	1-14
G62471-1210	12MBSPPOR-10MFFORL	7253-61965	3/4-14	1-14
G62471-1212	12MBSPPOR-12MFFORL	7253-61975	3/4-14	1 3/16-12
G62471-1616	16MBSPPOR-16MFFORL	7253-61985	1-11	1 7/16-12
G62471-2020	20MBSPPOR-20MFFORL	7253-61995	1 1/4-11	1 11/16-12

## Male British Standard Pipe Parallel with O-Ring to Male Flat-Face O-Ring - 45°

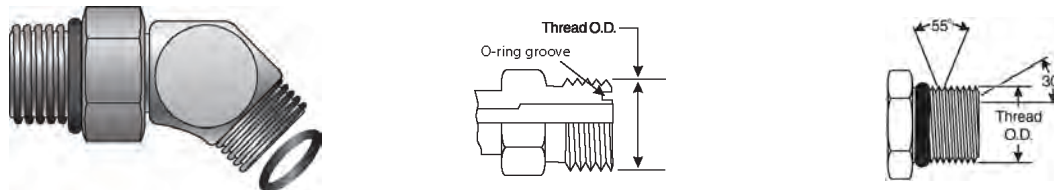

Part No.	Descr.	Prod. No.		
			"	"
G62473-0204	2MBSPPOR-4MFFOR45	7253-62005	1/8-28	9/16-18
G62473-0404	4MBSPPOR-4MFFOR45	7253-62015	1/4-19	9/16-18
G62473-0406	4MBSPPOR-6MFFOR45	7253-62025	1/4-19	11/16-16
G62473-0606	6MBSPPOR-6MFFOR45	7253-62035	3/8-19	11/16-16
G62473-0608	6MBSPPOR-8MFFOR45	7253-62045	3/8-19	13/16-16
G62473-0808	8MBSPPOR-8MFFOR45	7253-62055	1/2-14	13/16-16
G62473-0810	8MBSPPOR-10MFFOR45	7253-62065	1/2-14	1-14

- EQUIPMENT
- HOSE/CPLG. SELECTION
- G8K COUPLINGS
- GLOBALSPIRAL COUPLINGS
- STAINLESS STEEL SPIRAL
- MEGACRIMP COUPLINGS
- STAINLESS STEEL BRAID
- POWER CRIMP COUPLINGS
- FIELD ATTACHABLE G1 & G2 COUPLINGS
- FIELD ATTACHABLE C5 COUPLINGS
- C14 COUPLINGS
- GL COUPLINGS
- GLX COUPLINGS
- PCTS THERMOPLASTIC COUPLINGS
- POLARSEAL COUPLINGS (ACA)
- POLARSEAL II COUPLINGS (ACC)
- POLARSEAL II COUPLINGS (ACB)
- POWER STEERING
- ADAPTERS
- QUICK DISCONNECT COUPLERS
- BALL VALVES
- LIVE SWIVEL
- ASSEMBLY FABRICATION
- ACCESSORIES
- EQUIPMENT AND PARTS
- KITS
- AIR BRAKE HOSE ASSY
- BRASS



## Male British Standard Pipe Parallel with O-Ring to Male Flat-Face O-Ring - 90°

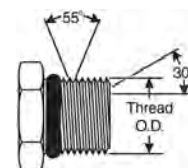
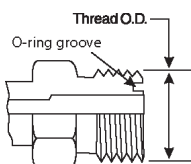
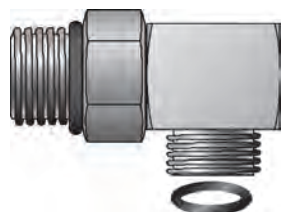

Part No.	Descr.	Prod. No.		
			"	"
G62475-0204	2MBSPPOR-4MFFOR90	7253-62075	1/8-28	9/16-18
G62475-0404	4MBSPPOR-4MFFOR90	7253-62085	1/4-19	9/16-18
G62475-0406	4MBSPPOR-6MFFOR90	7253-62095	1/4-19	11/16-16
G62475-0408	4MBSPPOR-8MFFOR90	7253-62105	1/4-19	13/16-16
G62475-0606	6MBSPPOR-6MFFOR90	7253-62115	3/8-19	11/16-16
G62475-0608	6MBSPPOR-8MFFOR90	7253-62125	3/8-19	13/16-16
G62475-0806	8MBSPPOR-6MFFOR90	7253-62135	1/2-14	11/16-16
G62475-0808	8MBSPPOR-8MFFOR90	7253-62145	1/2-14	13/16-16
G62475-0810	8MBSPPOR-10MFFOR90	7253-62155	1/2-14	1-14
G62475-0812	8MBSPPOR-12MFFOR90	7253-62165	1/2-14	1 3/16-12
G62475-1212	12MBSPPOR-12MFFOR90	7253-62175	3/4-14	1 3/16-12
G62475-1216	12MBSPPOR-16MFFOR90	7253-62185	3/4-14	1 7/16-12
G62475-1612	16MBSPPOR-12MFFOR90	7253-62195	1-11	1 3/16-12
G62475-1616	16MBSPPOR-16MFFOR90	7253-62205	1-11	1 7/16-12
G62475-2016	20MBSPPOR-16MFFOR90	7253-62215	1 1/4-11	1 7/16-12
G62475-2020	20MBSPPOR-20MFFOR90	7253-62225	1 1/4-11	1 11/16-12
G62475-2424	24MBSPPOR-24MFFOR90	7253-62235	1 1/2-11	2-12

## Female British Standard Pipe Parallel to Male Pipe NPTF

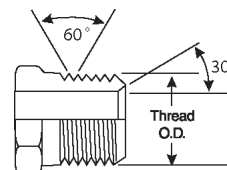
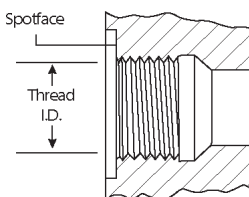
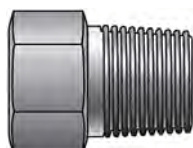

Part No.	Descr.	Prod. No.		
			"	"
G62500-0202	2FBSPP-2MP	7253-62245	1/8-28	1/8-27
G62500-0204	2FBSPP-4MP	7253-62255	1/8-28	1/4-18
G62500-0404	4FBSPP-4MP	7253-62265	1/4-19	1/4-18
G62500-0406	4FBSPP-6MP	7253-62275	1/4-19	3/8-18
G62500-0408	4FBSPP-8MP	7253-62285	1/4-19	1/2-14
G62500-0606	6FBSPP-6MP	7253-62295	3/8-19	3/8-18
G62500-0608	6FBSPP-8MP	7253-62305	3/8-19	1/2-14
G62500-0808	8FBSPP-8MP	7253-62315	1/2-14	1/2-14
G62500-0812	8FBSPP-12MP	7253-62325	1/2-14	3/4-14
G62500-1212	12FBSPP-12MP	7253-62335	3/4-14	3/4-14
G62500-1216	12FBSPP-16MP	7253-62345	3/4-14	1-11 1/2
G62500-1616	16FBSPP-16MP	7253-62355	1-11	1-11 1/2



Female British Standard Pipe Parallel to Male Pipe NPTF - Continued

Part No.	Descr.	Prod. No.		
			"	"
G62500-2020	20FBSPP-20MP	7253-62365	1 1/4-11	1 1/4-11 1/2
G62500-2024	20FBSPP-24MP	7253-62375	1 1/4-11	1 1/2-11 1/2
G62500-2424	24FBSPP-24MP	7253-62385	1 1/2-11	1 1/2-11 1/2
G62500-3232	32FBSPP-32MP	7253-62395	2-11	2-11 1/2

Female British Standard Pipe Parallel to Female Pipe NPTF

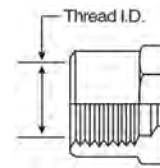
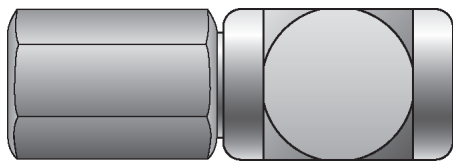

Part No.	Descr.	Prod. No.		
			"	"
G62520-0404	4FBSPP-4FP	7253-65525	1/4-19	1/4-18
G62520-0606	6FBSPP-6FP	7253-65535	3/8-19	3/8-18
G62520-0808	8FBSPP-8FP	7253-65545	1/2-14	1/2-14
G62520-1212	12FBSPP-12FP	7253-65555	3/4-14	3/4-14
G62520-1616	16FBSPP-16FP	7253-65565	1-11	1-11 1/2
G62520-2020	20FBSPP-20FP	7253-65575	1 1/4-11	1 1/4-11 1/2

Female British Standard Pipe Parallel to Male JIC 37° Flare

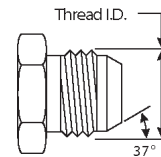
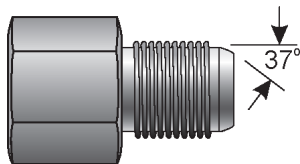



Part No.	Descr.	Prod. No.		
			"	"
G62550-0204	2FBSPP-4MJ	7253-14155	1/8-28	7/16-20
G62550-0404	4FBSPP-4MJ	7253-14225	1/4-19	7/16-20
G62550-0406	4FBSPP-6MJ	7253-14165	1/4-19	9/16-18
G62550-0606	6FBSPP-6MJ	7253-14175	3/8-19	9/16-18
G62550-0808	8FBSPP-8MJ	7253-14185	1/2-14	3/4-16
G62550-1212	12FBSPP-12MJ	7253-14195	3/4-14	1 1/16-12
G62550-1616	16FBSPP-16MJ	7253-14205	1-11	1 5/16-12
G62550-2020	20FBSPP-20MJ	7253-14215	1 1/4-11	1 5/8-12
G62550-2424	24FBSPP-24MJ	7253-62415	1 1/2-11	1 7/8-12

- EQUIPMENT
- HOSE/CPLG. SELECTION
- G8K COUPLINGS
- GLOBAL SPIRAL COUPLINGS
- STAINLESS STEEL SPIRAL
- MEGACRIMP COUPLINGS
- STAINLESS STEEL BRAID
- POWER CRIMP COUPLINGS
- FIELD ATTACHABLE G1 & G2 COUPLINGS
- FIELD ATTACHABLE C5 COUPLINGS
- C14 COUPLINGS
- GL COUPLINGS
- GLX COUPLINGS
- PCTS THERMOPLASTIC COUPLINGS
- POLARSEAL COUPLINGS (ACA)
- POLARSEAL II COUPLINGS (ACC)
- POLARSEAL II COUPLINGS (ACB)
- POWER STEERING
- ADAPTERS
- QUICK DISCONNECT COUPLERS
- BALL VALVES
- LIVE SWIVEL
- ASSEMBLY FABRICATION
- ACCESSORIES
- EQUIPMENT AND PARTS
- KITS
- AIR BRAKE HOSE ASSY
- BRASS



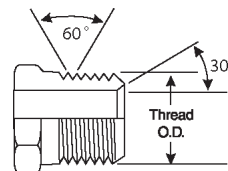
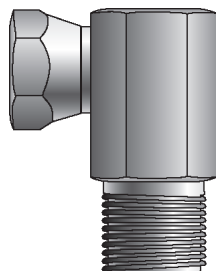

## Female British Standard Pipe Parallel Swivel to Male Pipe NPTF - 90°

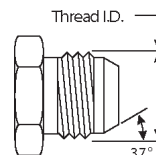
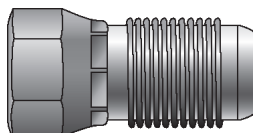

Part No.	Descr.	Prod. No.		
			"	"
G62605-0202	2FBSPPX-2MP90	7253-62425	1/8-28	1/8-27
G62605-0404	4FBSPPX-4MP90	7253-62435	1/4-19	1/4-18
G62605-0606	6FBSPPX-6MP90	7253-62445	3/8-19	3/8-18
G62605-0808	8FBSPPX-8MP90	7253-62455	1/2-14	1/2-14
G62605-1212	12FBSPPX-12MP90	7253-62465	3/4-14	3/4-14
G62605-1616	16FBSPPX-16MP90	7253-62475	1-11	1-11 1/2
G62605-2020	20FBSPPX-20MP90	7253-62485	1 1/4-11	1 1/4-11 1/2
G62605-2424	24FBSPPX-24MP90	7253-62495	1 1/2-11	1 1/2-11 1/2

## Female British Standard Pipe Parallel Swivel to Male JIC 37° Flare



Part No.	Descr.	Prod. No.		
			"	"
G62650-0204	2FBSPPX-4MJ	7253-62545	1/8-28	7/16-20
G62650-0404	4FBSPPX-4MJ	7253-15245	1/4-19	7/16-20
G62650-0405	4FBSPPX-5MJ	7253-62555	1/4-19	1/2-20
G62650-0406	4FBSPPX-6MJ	7253-62565	1/4-19	9/16-18
G62650-0604	6FBSPPX-4MJ	7253-62575	3/8-19	7/16-20
G62650-0605	6FBSPPX-5MJ	7253-62585	3/8-19	1/2-20
G62650-0606	6FBSPPX-6MJ	7253-15255	3/8-19	9/16-18
G62650-0608	6FBSPPX-8MJ	7253-62595	3/8-19	3/4-16
G62650-0610	6FBSPPX-10MJ	7253-62605	3/8-19	7/8-14
G62650-0806	8FBSPPX-6MJ	7253-62615	1/2-14	9/16-18
G62650-0808	8FBSPPX-8MJ	7253-15265	1/2-14	3/4-16
G62650-0810	8FBSPPX-10MJ	7253-62625	1/2-14	7/8-14
G62650-1008	10FBSPPX-8MJ	7253-62635	5/8-14	3/4-16
G62650-1010	10FBSPPX-10MJ	7253-15275	5/8-14	7/8-14
G62650-1208	12FBSPPX-8MJ	7253-62645	3/4-14	3/4-16
G62650-1210	12FBSPPX-10MJ	7253-62655	3/4-14	7/8-14
G62650-1212	12FBSPPX-12MJ	7253-15285	3/4-14	1 1/16-12
G62650-1216	12FBSPPX-16MJ	7253-62665	3/4-14	1 5/16-12
G62650-1612	16FBSPPX-12MJ	7253-62675	1-11	1 1/16-12
G62650-1616	16FBSPPX-16MJ	7253-15295	1-11	1 5/16-12
G62650-2020	20FBSPPX-20MJ	7253-62685	1 1/4-11	1 5/8-12
G62650-2424	24FBSPPX-24MJ	7253-62695	1 1/2-11	1 7/8-12



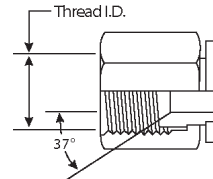
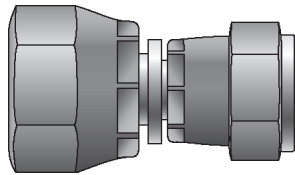

## Female British Standard Pipe Parallel Swivel to Female JIC 37° Flare Swivel

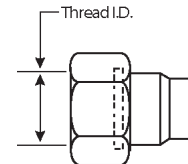
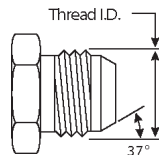
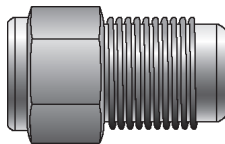

Part No.	Descr.	Prod. No.		
			"	"
G62660-0404	4FBSPPX-4FJX	7253-15305	1/4-19	7/16-20
G62660-0406	4FBSPPX-6FJX	7253-62505	1/4-19	9/16-18
G62660-0606	6FBSPPX-6FJX	7253-15315	3/8-19	9/16-18
G62660-0608	6FBSPPX-8FJX	7253-62515	3/8-19	3/4-16
G62660-0806	8FBSPPX-6FJX	7253-62525	1/2-14	9/16-18
G62660-0808	8FBSPPX-8FJX	7253-15325	1/2-14	3/4-16
G62660-1010	10FBSPPX-10FJX	7253-15335	5/8-14	7/8-14
G62660-1212	12FBSPPX-12FJX	7253-15345	3/4-14	1 1/16-12
G62660-1616	16FBSPPX-16FJX	7253-15355	1-11	1 5/16-12
G62660-2020	20FBSPPX-20FJX	7253-62535	1 1/4-11	1 5/8-12

## Female British Flat-Face O-Ring to Male JIC 37° Flare



Part No.	Descr.	Prod. No.		
			"	"
G62801-0606	6FBFFOR-6MJ	7253-62705	3/8-19	9/16-18
G62801-0806	8FBFFOR-6MJ	7253-62715	1/2-14	9/16-18
G62801-0808	8FBFFOR-8MJ	7253-62725	1/2-14	3/4-16
G62801-0810	8FBFFOR-10MJ	7253-62735	1/2-14	7/8-14
G62801-1008	10FBFFOR-8MJ	7253-62745	5/8-14	3/4-16
G62801-1208	12FBFFOR-8MJ	7253-62755	3/4-14	3/4-16
G62801-1210	12FBFFOR-10MJ	7253-62765	3/4-14	7/8-14
G62801-1212	12FBFFOR-12MJ	7253-62775	3/4-14	1 1/16-12

- EQUIPMENT
- HOSE/CPLG. SELECTION
- G8K COUPLINGS
- GLOBALSPIRAL COUPLINGS
- STAINLESS STEEL SPIRAL
- MEGACRIMP COUPLINGS
- STAINLESS STEEL BRAID
- POWER CRIMP COUPLINGS
- FIELD ATTACHABLE G1 & G2 COUPLINGS
- FIELD ATTACHABLE C5 COUPLINGS
- C14 COUPLINGS
- GL COUPLINGS
- GLX COUPLINGS
- PCTS THERMOPLASTIC COUPLINGS
- POLARSEAL COUPLINGS (ACA)
- POLARSEAL II COUPLINGS (ACC)
- POLARSEAL II COUPLINGS (ACB)
- POWER STEERING
- ADAPTERS
- QUICK DISCONNECT COUPLERS
- BALL VALVES
- LIVE SWIVEL
- ASSEMBLY FABRICATION
- ACCESSORIES
- EQUIPMENT AND PARTS
- KITS
- AIR BRAKE HOSE ASSY
- BRASS



EQUIPMENT
HOSE/CPLG. SELECTION
G8K COUPLINGS
GLOBAL SPIRAL COUPLINGS
STAINLESS STEEL SPIRAL
MEGACRIMP COUPLINGS
STAINLESS STEEL BRAID
POWER CRIMP COUPLINGS
FIELD ATTACHABLE G1 & G2 COUPLINGS
FIELD ATTACHABLE C5 COUPLINGS
C14 COUPLINGS
GL COUPLINGS
GLX COUPLINGS
PCTS THERMOPLASTIC COUPLINGS
POLARSEAL COUPLINGS (ACA)
POLARSEAL II COUPLINGS (ACC)
POLARSEAL II COUPLINGS (ACB)
POWER STEERING
ADAPTERS
QUICK DISCONNECT COUPLERS
BALL VALVES
LIVE SWIVEL
ASSEMBLY FABRICATION
ACCESSORIES
EQUIPMENT AND PARTS
KITS
AIR BRAKE HOSE ASSY
BRASS

### Male Metric O-Ring Plug



Part No.	Descr.	Prod. No.	Metric	
			"	"
G63099-0012	12MMOR-PLUG	7253-65415	M12X1.5	
G63099-0014	14MMOR-PLUG	7253-65425	M14X1.5	
G63099-0016	16MMOR-PLUG	7253-65435	M16X1.5	
G63099-0018	18MMOR-PLUG	7253-65445	M18X1.5	
G63099-0020	20MMOR-PLUG	7253-65455	M20X1.5	
G63099-0022	22MMOR-PLUG	7253-65465	M22X1.5	
G63099-0024	24MMOR-PLUG	7253-65475	M24X1.5	
G63099-0026	26MMOR-PLUG	7253-65485	M26X1.5	
G63099-0030	30MMOR-PLUG	7253-65495	M30X2.0	
G63099-0036	36MMOR-PLUG	7253-65505	M36X2.0	
G63099-0042	42MMOR-PLUG	7253-65515	M42X2.0	

### Male Metric with O-Ring to Female Pipe NPTF

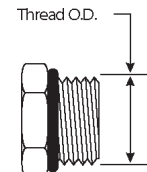
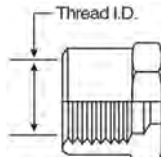

Part No.	Descr.	Prod. No.	Metric	
			"	"
G63120-1002	10MM-2FP	7253-62785	M10X1.0	1/8-27
G63120-1202	12MM-2FP	7253-62795	M12X1.5	1/8-27
G63120-1204	12MM-4FP	7253-62805	M12X1.5	1/4-18
G63120-1206	12MM-6FP	7253-62815	M12X1.5	3/8-18
G63120-1404	14MM-4FP	7253-62825	M14X1.5	1/4-18
G63120-1606	16MM-6FP	7253-62835	M16X1.5	3/8-18
G63120-1608	16MM-8FP	7253-62845	M16X1.5	1/2-14
G63120-1806	18MM-6FP	7253-62855	M18X1.5	3/8-18
G63120-1808	18MM-8FP	7253-62865	M18X1.5	1/2-14
G63120-2004	20MM-4FP	7253-62875	M20X1.5	1/4-18
G63120-2006	20MM-6FP	7253-62885	M20X1.5	3/8-18
G63120-2008	20MM-8FP	7253-62895	M20X1.5	1/2-14
G63120-2206	22MM-6FP	7253-62905	M22X1.5	3/8-18
G63120-2208	22MM-8FP	7253-62915	M22X1.5	1/2-14
G63120-2212	22MM-12FP	7253-62925	M22X1.5	3/4-14
G63120-2412	24MM-12FP	7253-62935	M24X1.5	3/4-14
G63120-2612	26MM-12FP	7253-62945	M26X1.5	3/4-14
G63120-2712	27MM-12FP	7253-62955	M27X2.0	3/4-14
G63120-3316	33MM-16FP	7253-62965	M33X2.0	1-11 1/2



### Male Metric with O-Ring to Male JIC 37° Flare

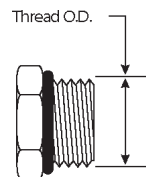
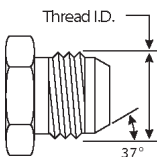
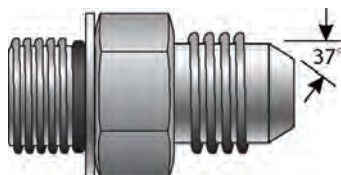

Part No.	Descr.	Prod. No.		
			"	"
G63150-1004	10MM-4MJ	7253-14355	M10X1.0	7/16-20
G63150-1204	12MM-4MJ	7253-14365	M12X1.5	7/16-20
G63150-1205	12MM-5MJ	7253-62975	M12X1.5	1/2-20
G63150-1206	12MM-6MJ	7253-62985	M12X1.5	9/16-18
G63150-1404	14MM-4MJ	7253-62995	M14X1.5	7/16-20
G63150-1406	14MM-6MJ	7253-14375	M14X1.5	9/16-18
G63150-1408	14MM-8MJ	7253-63005	M14X1.5	3/4-16
G63150-1605	16MM-5MJ	7253-63015	M16X1.5	1/2-20
G63150-1606	16MM-6MJ	7253-14385	M16X1.5	9/16-18
G63150-1608	16MM-8MJ	7253-14395	M16X1.5	3/4-16
G63150-1808	18MM-8MJ	7253-14405	M18X1.5	3/4-16
G63150-1810	18MM-10MJ	7253-14415	M18X1.5	7/8-14
G63150-2010	20MM-10MJ	7253-14425	M20X1.5	7/8-14
G63150-2208	22MM-8MJ	7253-63025	M22X1.5	3/4-16
G63150-2210	22MM-10MJ	7253-14435	M22X1.5	7/8-14
G63150-2212	22MM-12MJ	7253-14445	M22X1.5	1 1/16-12
G63150-2612	26MM-12MJ	7253-63035	M26X1.5	1 1/16-12
G63150-2712	27MM-12MJ	7253-14455	M27X2.0	1 1/16-12
G63150-2716	27MM-16MJ	7253-63045	M27X2.0	1 5/16-12
G63150-3316	33MM-16MJ	7253-14465	M33X2.0	1 5/16-12
G63150-3320	33MM-20MJ	7253-63055	M33X2.0	1 5/8-12
G63150-4220	42MM-20MJ	7253-14475	M42X2.0	1 5/8-12
G63150-4824	48MM-24MJ	7253-63065	M48X2.0	1 7/8-12

### Male Metric with O-Ring to Male JIC 37° Flare - 90°

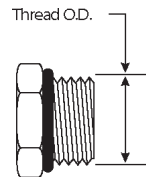
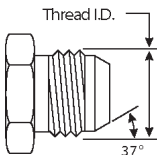

Part No.	Descr.	Prod. No.		
			"	"
G63160-1004	10MM-4MJ90	7253-65585	M10X1.0	7/16-20
G63160-1204	12MM-4MJ90	7253-65595	M12X1.5	7/16-20
G63160-1205	12MM-5MJ90	7253-65615	M12X1.5	1/2-20
G63160-1206	12MM-6MJ90	7253-65625	M12X1.5	9/16-18
G63160-1404	14MM-4MJ90	7253-65605	M14X1.5	7/16-20
G63160-1406	14MM-6MJ90	7253-65635	M14X1.5	9/16-18

- EQUIPMENT
- HOSE/CPLG. SELECTION
- G8K COUPLINGS
- GLOBAL SPIRAL COUPLINGS
- STAINLESS STEEL SPIRAL
- MEGACRIMP COUPLINGS
- STAINLESS STEEL BRAID
- POWER CRIMP COUPLINGS
- FIELD ATTACHABLE G1 & G2 COUPLINGS
- FIELD ATTACHABLE C5 COUPLINGS
- C14 COUPLINGS
- GL COUPLINGS
- GLX COUPLINGS
- PCTS THERMOPLASTIC COUPLINGS
- POLARSEAL COUPLINGS (ACA)
- POLARSEAL II COUPLINGS (ACC)
- POLARSEAL II COUPLINGS (ACB)
- POWER STEERING
- ADAPTERS
- QUICK DISCONNECT COUPLERS
- BALL VALVES
- LIVE SWIVEL
- ASSEMBLY FABRICATION
- ACCESSORIES
- EQUIPMENT AND PARTS
- KITS
- AIR BRAKE HOSE ASSY
- BRASS







Male Metric with O-Ring to Male JIC 37° Flare - 90° - Continued

EQUIPMENT
HOSE/CPLG. SELECTION
G8K COUPLINGS
GLOBAL SPIRAL COUPLINGS
STAINLESS STEEL SPIRAL
MEGACRIMP COUPLINGS
STAINLESS STEEL BRAID
POWER CRIMP COUPLINGS
FIELD ATTACHABLE G1 & G2 COUPLINGS
FIELD ATTACHABLE C5 COUPLINGS
C14 COUPLINGS
GL COUPLINGS
GLX COUPLINGS
PCTS THERMOPLASTIC COUPLINGS
POLARSEAL COUPLINGS (ACA)
POLARSEAL II COUPLINGS (ACC)
POLARSEAL II COUPLINGS (ACB)
POWER STEERING
ADAPTERS
QUICK DISCONNECT COUPLERS
BALL VALVES
LIVE SWIVEL
ASSEMBLY FABRICATION
ACCESSORIES
EQUIPMENT AND PARTS
KITS
AIR BRAKE HOSE ASSY
BRASS

Part No.	Descr.	Prod. No.		
			"	"
G63160-1606	16MM-6MJ90	7253-65645	M16X1.5	9/16-18
G63160-1608	16MM-8MJ90	7253-65655	M16X1.5	3/4-16
G63160-1808	18MM-8MJ90	7253-65665	M18X1.5	3/4-16
G63160-1810	18MM-10MJ90	7253-65685	M18X1.5	7/8-14
G63160-2010	20MM-10MJ90	7253-65695	M20X1.5	7/8-14
G63160-2208	22MM-8MJ90	7253-65675	M22X1.5	3/4-16
G63160-2210	22MM-10MJ90	7253-65705	M22X1.5	7/8-14
G63160-2212	22MM-12MJ90	7253-65715	M22X1.5	1 1/16-12
G63160-2612	26MM-12MJ90	7253-65725	M26X1.5	1 1/16-12
G63160-2716	27MM-16MJ90	7253-65735	M27X2.0	1 5/16-12
G63160-3316	33MM-16MJ90	7253-65745	M33X2.0	1 5/16-12
G63160-4220	42MM-20MJ90	7253-65755	M42X2.0	1 5/8-12

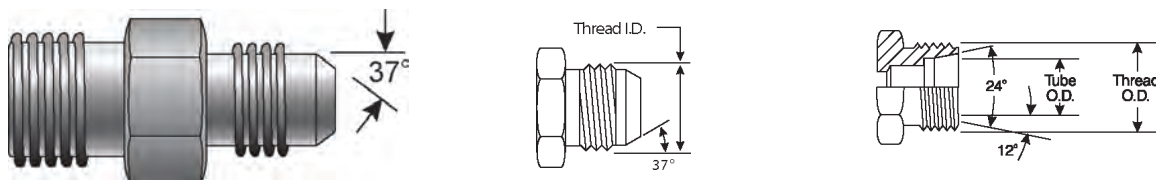
Male DIN 24° Cone - Light Series to Male JIC 37° Flare





Part No.	Descr.	Prod. No.		
			"	"
G63350-0604	6MDL-4MJ	7253-63075	M12X1.5	7/16-20
G63350-0804	8MDL-4MJ	7253-15365	M14X1.5	7/16-20
G63350-0806	8MDL-6MJ	7253-63095	M14X1.5	9/16-18
G63350-1004	10MDL-4MJ	7253-63105	M16X1.5	7/16-20
G63350-1006	10MDL-6MJ	7253-15375	M16X1.5	9/16-18
G63350-1008	10MDL-8MJ	7253-63115	M16X1.5	3/4-16
G63350-1206	12MDL-6MJ	7253-15585	M18X1.5	9/16-18
G63350-1208	12MDL-8MJ	7253-63135	M18X1.5	3/4-16
G63350-1508	15MDL-8MJ	7253-15385	M22X1.5	3/4-16
G63350-1510	15MDL-10MJ	7253-63145	M22X1.5	7/8-14
G63350-1512	15MDL-12MJ	7253-63155	M22X1.5	1 1/16-12
G63350-1810	18MDL-10MJ	7253-15515	M26X1.5	7/8-14
G63350-1812	18MDL-12MJ	7253-63165	M26X1.5	1 1/16-12
G63350-2212	22MDL-12MJ	7253-15395	M30X2.0	1 1/16-12
G63350-2816	28MDL-16MJ	7253-15405	M36X2.0	1 5/16-12
G63350-3520	35MDL-20MJ	7253-63175	M45X2.0	1 5/8-12
G63350-4224	42MDL-24MJ	7253-63185	M52X2.0	1 7/8-12





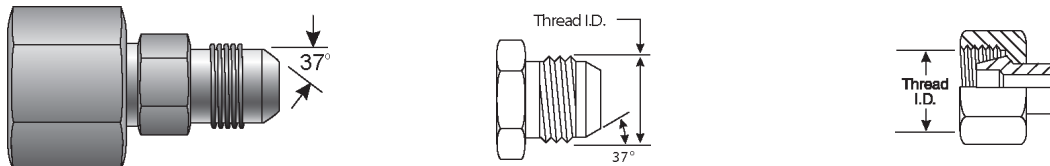

### Female DIN 24° Cone Swivel - Light Series to Male JIC 37° Flare

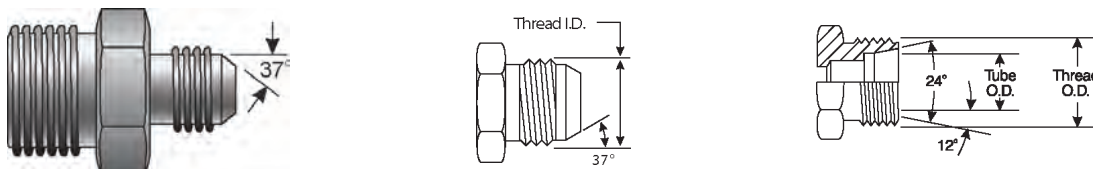

Part No.	Descr.	Prod. No.		
			"	"
G63450-0604	6FDLX-4MJ	7253-64725	M12X1.5	7/16-20
G63450-0605	6FDLX-5MJ	7253-64735	M12X1.5	1/2-20
G63450-0804	8FDLX-4MJ	7253-15465	M14X1.5	7/16-20
G63450-0806	8FDLX-6MJ	7253-64755	M14X1.5	9/16-18
G63450-1006	10FDLX-6MJ	7253-15475	M16X1.5	9/16-18
G63450-1008	10FDLX-8MJ	7253-64775	M16X1.5	3/4-16
G63450-1206	12FDLX-6MJ	7253-15545	M18X1.5	9/16-18
G63450-1208	12FDLX-8MJ	7253-64795	M18X1.5	3/4-16
G63450-1210	12FDLX-10MJ	7253-64805	M18X1.5	7/8-14
G63450-1506	15FDLX-6MJ	7253-64815	M22X1.5	9/16-18
G63450-1508	15FDLX-8MJ	7253-15485	M22X1.5	3/4-16
G63450-1510	15FDLX-10MJ	7253-64835	M22X1.5	7/8-14
G63450-2212	22FDLX-12MJ	7253-15495	M30X2.0	1 1/16-12
G63450-2816	28FDLX-16MJ	7253-15505	M36X2.0	1 5/16-12

### Male DIN 24° Cone - Heavy Series to Male JIC 37° Flare



Part No.	Descr.	Prod. No.		
			"	"
G63650-0604	6MDH-4MJ	7253-63195	M14X1.5	7/16-20
G63650-0804	8MDH-4MJ	7253-63205	M16X1.5	7/16-20
G63650-0806	8MDH-6MJ	7253-63215	M16X1.5	9/16-18
G63650-1004	10MDH-4MJ	7253-15415	M18X1.5	7/16-20
G63650-1008	10MDH-8MJ	7253-63225	M18X1.5	3/4-16
G63650-1206	12MDH-6MJ	7253-63235	M20X1.5	9/16-18
G63650-1208	12MDH-8MJ	7253-63245	M20X1.5	3/4-16
G63650-1210	12MDH-10MJ	7253-63255	M20X1.5	7/8-14
G63650-1406	14MDH-6MJ	7253-15425	M22X1.5	9/16-18
G63650-1408	14MDH-8MJ	7253-63265	M22X1.5	3/4-16
G63650-1608	16MDH-8MJ	7253-15435	M24X1.5	3/4-16
G63650-1610	16MDH-10MJ	7253-63285	M24X1.5	7/8-14
G63650-1612	16MDH-12MJ	7253-63275	M24X1.5	1 1/16-12
G63650-2010	20MDH-10MJ	7253-15525	M30X2.0	7/8-14
G63650-2012	20MDH-12MJ	7253-63295	M30X2.0	1 1/16-12
G63650-2512	25MDH-12MJ	7253-15445	M36X2.0	1 1/16-12
G63650-2516	25MDH-16MJ	7253-63305	M36X2.0	1 5/16-12
G63650-3016	30MDH-16MJ	7253-15455	M42X2.0	1 5/16-12
G63650-3820	38MDH-20MJ	7253-63315	M52X2.0	1 5/8-12

EQUIPMENT
HOSE/CPLG. SELECTION
G8K COUPLINGS
GLOBALSPIRAL COUPLINGS
STAINLESS STEEL SPIRAL
MEGACRIMP COUPLINGS
STAINLESS STEEL BRAID
POWER CRIMP COUPLINGS
FIELD ATTACHABLE G1 & G2 COUPLINGS
FIELD ATTACHABLE C5 COUPLINGS
C14 COUPLINGS
GL COUPLINGS
GLX COUPLINGS
PCTS THERMOPLASTIC COUPLINGS
POLARSEAL COUPLINGS (ACA)
POLARSEAL II COUPLINGS (ACC)
POLARSEAL II COUPLINGS (ACB)
POWER STEERING
ADAPTERS
QUICK DISCONNECT COUPLERS
BALL VALVES
LIVE SWIVEL
ASSEMBLY FABRICATION
ACCESSORIES
EQUIPMENT AND PARTS
KITS
AIR BRAKE HOSE ASSY
BRASS





EQUIPMENT
HOSE/CPLG. SELECTION
G8K COUPLINGS
GLOBAL SPIRAL COUPLINGS
STAINLESS STEEL SPIRAL
MEGACRIMP COUPLINGS
STAINLESS STEEL BRAID
POWER CRIMP COUPLINGS
FIELD ATTACHABLE G1 & G2 COUPLINGS
FIELD ATTACHABLE C5 COUPLINGS
C14 COUPLINGS
GL COUPLINGS
GLX COUPLINGS
PCTS THERMOPLASTIC COUPLINGS
POLARSEAL COUPLINGS (ACA)
POLARSEAL II COUPLINGS (ACC)
POLARSEAL II COUPLINGS (ACB)
POWER STEERING
ADAPTERS
QUICK DISCONNECT COUPLERS
BALL VALVES
LIVE SWIVEL
ASSEMBLY FABRICATION
ACCESSORIES
EQUIPMENT AND PARTS
KITS
AIR BRAKE HOSE ASSY
BRASS

### Male DIN 24° Cone - Heavy Series to Male JIC 37° Flare - Continued

Part No.	Descr.	Prod. No.		
			"	"
G63650-3824	38MDH-24MJ	7253-63325	M52X2.0	1 7/8-12

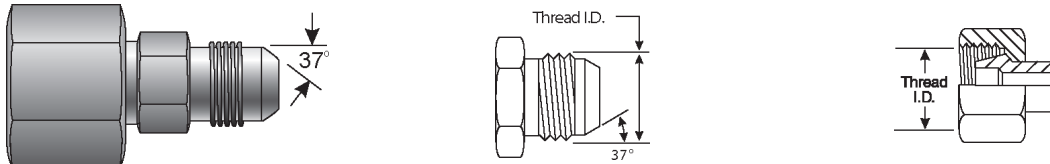
### Female DIN 24° Cone Swivel - Heavy Series to Male JIC 37° Flare



Part No.	Descr.	Prod. No.		
			"	"
G63750-1004	10FDHX-4MJ	7253-15605	M18X1.5	7/16-20
G63750-1205	12FDHX-5MJ	7253-15615	M20X1.5	1/2-20
G63750-1206	12FDHX-6MJ	7253-64845	M20X1.5	9/16-18
G63750-1208	12FDHX-8MJ	7253-64855	M20X1.5	3/4-16
G63750-1210	12FDHX-10MJ	7253-64865	M20X1.5	7/8-14
G63750-1406	14FDHX-6MJ	7253-15625	M22X1.5	9/16-18
G63750-1608	16FDHX-8MJ	7253-15635	M24X1.5	3/4-16
G63750-2010	20FDHX-10MJ	7253-15645	M30X2.0	7/8-14
G63750-2512	25FDHX-12MJ	7253-15655	M36X2.0	1 1/16-12
G63750-3016	30FDHX-16MJ	7253-15665	M42X2.0	1 5/16-12
G63750-3820	38FDHX-20MJ	7253-15675	M52X2.0	1 5/8-12

### Male Kobelco Plug



Part No.	Descr.	Prod. No.	
			"
G63980-0022	22MKB-PLUG	7253-65295	M30X1.5



### Male Kobelco to Male JIC 37° Flare

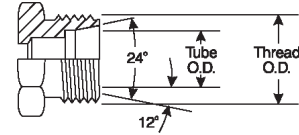
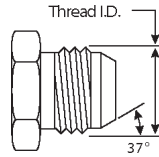
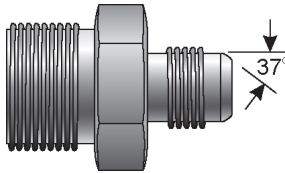

Part No.	Descr.	Prod. No.		
			"	"
G63990-2212	22MKB-12MJ	7253-66105	M30X1.5	1 1/16-12
G63990-2812	28MKB-12MJ	7253-65305	M36X1.5	1 1/16-12
G63990-2816	28MKB-16MJ	7253-65315	M36X1.5	1 5/16-12
G63990-3516	35MKB-16MJ	7253-65325	M45X1.5	1 5/16-12
G63990-3520	35MKB-20MJ	7253-65335	M45X1.5	1 5/8-12

- EQUIPMENT
- HOSE/CPLG. SELECTION
- G8K COUPLINGS
- GLOBALSPIRAL COUPLINGS
- STAINLESS STEEL SPIRAL
- MEGACRIMP COUPLINGS
- STAINLESS STEEL BRAID
- POWER CRIMP COUPLINGS
- FIELD ATTACHABLE G1 & G2 COUPLINGS
- FIELD ATTACHABLE C5 COUPLINGS
- C14 COUPLINGS
- GL COUPLINGS
- GLX COUPLINGS
- PCTS THERMOPLASTIC COUPLINGS
- POLARSEAL COUPLINGS (ACA)
- POLARSEAL II COUPLINGS (ACC)
- POLARSEAL II COUPLINGS (ACB)
- POWER STEERING
- ADAPTERS**
- QUICK DISCONNECT COUPLERS
- BALL VALVES
- LIVE SWIVEL
- ASSEMBLY FABRICATION
- ACCESSORIES
- EQUIPMENT AND PARTS
- KITS
- AIR BRAKE HOSE ASSY
- BRASS



EQUIPMENT
HOSE/CPLG. SELECTION
G8K COUPLINGS
GLOBAL SPIRAL COUPLINGS
STAINLESS STEEL SPIRAL
MEGACRIMP COUPLINGS
STAINLESS STEEL BRAID
POWER CRIMP COUPLINGS
FIELD ATTACHABLE G1 & G2 COUPLINGS
FIELD ATTACHABLE C5 COUPLINGS
C14 COUPLINGS
GL COUPLINGS
GLX COUPLINGS
PCTS THERMOPLASTIC COUPLINGS
POLARSEAL COUPLINGS (ACA)
POLARSEAL II COUPLINGS (ACC)
POLARSEAL II COUPLINGS (ACB)
POWER STEERING
ADAPTERS
QUICK DISCONNECT COUPLERS
BALL VALVES
LIVE SWIVEL
ASSEMBLY FABRICATION
ACCESSORIES
EQUIPMENT AND PARTS
KITS
AIR BRAKE HOSE ASSY
BRASS

## British Bonded Seal



Part No.	Descr.	Prod. No.	
			"
G64075-0002	2BBDS	7253-63335	3/8
G64075-0004	4BBDS	7253-63345	17/32
G64075-0006	6BBDS	7253-63355	21/32
G64075-0008	8BBDS	7253-63365	13/16
G64075-0010	10BBDS	7253-63375	29/32
G64075-0012	12BBDS	7253-63385	1 1/32
G64075-0016	16BBDS	7253-63395	1 11/32
G64075-0020	20BBDS	7253-63405	1 21/32
G64075-0024	24BBDS	7253-63415	1 7/8
G64075-0032	32BBDS	7253-63425	2 11/32
G64075-0040	40BBDS	7253-63435	2 1/2
G64075-0048	48BBDS	7253-63445	3

## Male British Standard Pipe Parallel with O-Ring Plug

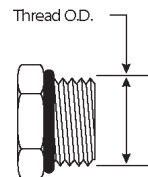
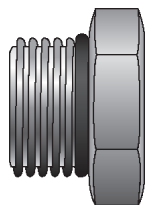

Part No.	Descr.	Prod. No.	
			"
G64094-0002	2MBSPOR-PLUG	7253-65345	1/8-28
G64094-0004	4MBSPOR-PLUG	7253-65355	1/4-19
G64094-0006	6MBSPOR-PLUG	7253-65365	3/8-19
G64094-0008	8MBSPOR-PLUG	7253-65375	1/2-14
G64094-0012	12MBSPOR-PLUG	7253-65385	3/4-14
G64094-0016	16MBSPOR-PLUG	7253-65395	1-11
G64094-0020	20MBSPOR-PLUG	7253-65405	1 1/4-11



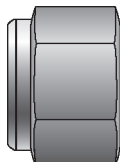

## Female British Standard Pipe Parallel Cap

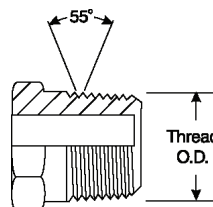
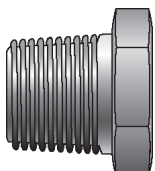

Part No.	Descr.	Prod. No.	
			"
G64097-0002	2FBSPP-CAP	7253-63455	1/8-28
G64097-0004	4FBSPP-CAP	7253-63465	1/4-19
G64097-0006	6FBSPP-CAP	7253-63475	3/8-19
G64097-0008	8FBSPP-CAP	7253-63485	1/2-14
G64097-0010	10FBSPP-CAP	7253-63495	5/8-14
G64097-0012	12FBSPP-CAP	7253-63505	3/4-14
G64097-0016	16FBSPP-CAP	7253-63515	1-11
G64097-0020	20FBSPP-CAP	7253-63525	1 1/4-11
G64097-0024	24FBSPP-CAP	7253-63535	1 1/2-11
G64097-0032	32FBSPP-CAP	7253-63545	2-11

## Male British Standard Pipe Tapered Thread Plug



Part No.	Descr.	Prod. No.	
			"
G64098-0002	2MBSPT-PLUG	7253-63555	1/8-28
G64098-0004	4MBSPT-PLUG	7253-63565	1/4-19
G64098-0006	6MBSPT-PLUG	7253-63575	3/8-19
G64098-0008	8MBSPT-PLUG	7253-63585	1/2-14
G64098-0010	10MBSPT-PLUG	7253-63595	5/8-14
G64098-0012	12MBSPT-PLUG	7253-63605	3/4-14
G64098-0016	16MBSPT-PLUG	7253-63615	1-11
G64098-0020	20MBSPT-PLUG	7253-63625	1 1/4-11
G64098-0024	24MBSPT-PLUG	7253-63635	1 1/2-11

EQUIPMENT
HOSE/CPLG. SELECTION
G8K COUPLINGS
GLOBALSPIRAL COUPLINGS
STAINLESS STEEL SPIRAL
MEGACRIMP COUPLINGS
STAINLESS STEEL BRAID
POWER CRIMP COUPLINGS
FIELD ATTACHABLE G1 & G2 COUPLINGS
FIELD ATTACHABLE C5 COUPLINGS
C14 COUPLINGS
GL COUPLINGS
GLX COUPLINGS
PCTS THERMOPLASTIC COUPLINGS
POLARSEAL COUPLINGS (ACA)
POLARSEAL II COUPLINGS (ACC)
POLARSEAL II COUPLINGS (ACB)
POWER STEERING
ADAPTERS
QUICK DISCONNECT COUPLERS
BALL VALVES
LIVE SWIVEL
ASSEMBLY FABRICATION
ACCESSORIES
EQUIPMENT AND PARTS
KITS
AIR BRAKE HOSE ASSY
BRASS



EQUIPMENT
HOSE/CPLG. SELECTION
G8K COUPLINGS
GLOBAL SPIRAL COUPLINGS
STAINLESS STEEL SPIRAL
MEGACRIMP COUPLINGS
STAINLESS STEEL BRAID
POWER CRIMP COUPLINGS
FIELD ATTACHABLE G1 & G2 COUPLINGS
FIELD ATTACHABLE C5 COUPLINGS
C14 COUPLINGS
GL COUPLINGS
GLX COUPLINGS
PCTS THERMOPLASTIC COUPLINGS
POLARSEAL COUPLINGS (ACA)
POLARSEAL II COUPLINGS (ACC)
POLARSEAL II COUPLINGS (ACB)
POWER STEERING
ADAPTERS
QUICK DISCONNECT COUPLERS
BALL VALVES
LIVE SWIVEL
ASSEMBLY FABRICATION
ACCESSORIES
EQUIPMENT AND PARTS
KITS
AIR BRAKE HOSE ASSY
BRASS

### Male British Standard Pipe Parallel Plug

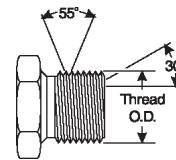
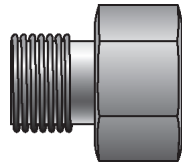

Part No.	Descr.	Prod. No.		
			"	"
G64099-0002	2MBSPP-PLUG	7253-63655	1/8-28	
G64099-0004	4MBSPP-PLUG	7253-63665	1/4-19	
G64099-0006	6MBSPP-PLUG	7253-63675	3/8-19	
G64099-0008	8MBSPP-PLUG	7253-63685	1/2-14	
G64099-0010	10MBSPP-PLUG	7253-63695	5/8-14	
G64099-0012	12MBSPP-PLUG	7253-63705	3/4-14	
G64099-0016	16MBSPP-PLUG	7253-63715	1-11	
G64099-0020	20MBSPP-PLUG	7253-63725	1 1/4-11	
G64099-0024	24MBSPP-PLUG	7253-63735	1 1/2-11	
G64099-0032	32MBSPP-PLUG	7253-63745	2-11	

### Male British Standard Pipe Parallel to Female British Standard Pipe Parallel Swivel

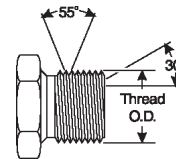
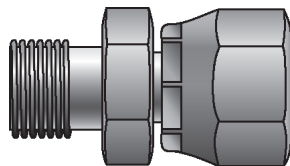

Part No.	Descr.	Prod. No.		
			"	"
G64350-0202	2MBSPP-2FBSPPX	7253-63775	1/8-28	1/8-28
G64350-0204	2MBSPP-4FBSPPX	7253-63785	1/8-28	1/4-19
G64350-0402	4MBSPP-2FBSPPX	7253-63795	1/4-19	1/8-28
G64350-0404	4MBSPP-4FBSPPX	7253-15185	1/4-19	1/4-19
G64350-0406	4MBSPP-6FBSPPX	7253-63805	1/4-19	3/8-19
G64350-0408	4MBSPP-8FBSPPX	7253-63815	1/4-19	1/2-14
G64350-0604	6MBSPP-4FBSPPX	7253-63825	3/8-19	1/4-19
G64350-0606	6MBSPP-6FBSPPX	7253-15195	3/8-19	3/8-19
G64350-0608	6MBSPP-8FBSPPX	7253-63835	3/8-19	1/2-14
G64350-0806	8MBSPP-6FBSPPX	7253-63845	1/2-14	3/8-19
G64350-0808	8MBSPP-8FBSPPX	7253-15205	1/2-14	1/2-14
G64350-0810	8MBSPP-10FBSPPX	7253-63855	1/2-14	5/8-14
G64350-0812	8MBSPP-12FBSPPX	7253-63865	1/2-14	3/4-14
G64350-1008	10MBSPP-8FBSPPX	7253-63875	5/8-14	1/2-14
G64350-1010	10MBSPP-10FBSPPX	7253-15215	5/8-14	5/8-14
G64350-1012	10MBSPP-12FBSPPX	7253-63885	5/8-14	3/4-14
G64350-1206	12MBSPP-6FBSPPX	7253-63895	3/4-14	3/8-19
G64350-1208	12MBSPP-8FBSPPX	7253-63905	3/4-14	1/2-14
G64350-1210	12MBSPP-10FBSPPX	7253-63915	3/4-14	5/8-14
G64350-1212	12MBSPP-12FBSPPX	7253-15225	3/4-14	3/4-14
G64350-1216	12MBSPP-16FBSPPX	7253-63925	3/4-14	1-11
G64350-1220	12MBSPP-20FBSPPX	7253-63935	3/4-14	1 1/4-11



Male British Standard Pipe Parallel to Female British Standard Pipe Parallel Swivel - Continued

Part No.	Descr.	Prod. No.		
			"	"
G64350-1612	16MBSPP-12FBSPPX	7253-63945	1-11	3/4-14
G64350-1616	16MBSPP-16FBSPPX	7253-15235	1-11	1-11
G64350-1620	16MBSPP-20FBSPPX	7253-63955	1-11	1 1/4-11
G64350-2016	20MBSPP-16FBSPPX	7253-63965	1 1/4-11	1-11
G64350-2020	20MBSPP-20FBSPPX	7253-63975	1 1/4-11	1 1/4-11
G64350-2024	20MBSPP-24FBSPPX	7253-63985	1 1/4-11	1 1/2-11
G64350-2420	24MBSPP-20FBSPPX	7253-63995	1 1/2-11	1 1/4-11
G64350-2424	24MBSPP-24FBSPPX	7253-64005	1 1/2-11	1 1/2-11
G64350-3232	32MBSPP-32FBSPPX	7253-64015	2-11	2-11

Metric Bonded Seal



Part No.	Descr.	Prod. No.	
			mm
G64775-0006	6MBDS	7253-64025	6.0
G64775-0008	8MBDS	7253-64035	8.0
G64775-0010	10MBDS	7253-64045	10.0
G64775-0012	12MBDS	7253-64055	12.0
G64775-0014	14MBDS	7253-64065	14.0
G64775-0016	16MBDS	7253-64075	16.0
G64775-0018	18MBDS	7253-64085	18.0
G64775-0020	20MBDS	7253-64095	20.0
G64775-0022	22MBDS	7253-64105	22.0
G64775-0024	24MBDS	7253-64115	24.0
G64775-0026	26MBDS	7253-64125	26.0
G64775-0027	27MBDS	7253-64135	27.0
G64775-0030	30MBDS	7253-64145	30.0
G64775-0033	33MBDS	7253-64155	33.0
G64775-0036	36MBDS	7253-64165	36.0
G64775-0042	42MBDS	7253-64175	42.0
G64775-0045	45MBDS	7253-64185	45.0
G64775-0050	50MBDS	7253-64195	50.0
G64775-0052	52MBDS	7253-64205	52.0

- EQUIPMENT
- HOSE/CPLG. SELECTION
- G8K COUPLINGS
- GLOBAL SPIRAL COUPLINGS
- STAINLESS STEEL SPIRAL
- MEGACRIMP COUPLINGS
- STAINLESS STEEL BRAID
- POWER CRIMP COUPLINGS
- FIELD ATTACHABLE G1 & G2 COUPLINGS
- FIELD ATTACHABLE C5 COUPLINGS
- C14 COUPLINGS
- GL COUPLINGS
- GLX COUPLINGS
- PCTS THERMOPLASTIC COUPLINGS
- POLARSEAL COUPLINGS (ACA)
- POLARSEAL II COUPLINGS (ACC)
- POLARSEAL II COUPLINGS (ACB)
- POWER STEERING
- ADAPTERS
- QUICK DISCONNECT COUPLERS
- BALL VALVES
- LIVE SWIVEL
- ASSEMBLY FABRICATION
- ACCESSORIES
- EQUIPMENT AND PARTS
- KITS
- AIR BRAKE HOSE ASSY
- BRASS



EQUIPMENT
HOSE/CPLG. SELECTION
G8K COUPLINGS
GLOBAL SPIRAL COUPLINGS
STAINLESS STEEL SPIRAL
MEGACRIMP COUPLINGS
STAINLESS STEEL BRAID
POWER CRIMP COUPLINGS
FIELD ATTACHABLE G1 & G2 COUPLINGS
FIELD ATTACHABLE C5 COUPLINGS
C14 COUPLINGS
GL COUPLINGS
GLX COUPLINGS
PCTS THERMOPLASTIC COUPLINGS
POLARSEAL COUPLINGS (ACA)
POLARSEAL II COUPLINGS (ACC)
POLARSEAL II COUPLINGS (ACB)
POWER STEERING
ADAPTERS
QUICK DISCONNECT COUPLERS
BALL VALVES
LIVE SWIVEL
ASSEMBLY FABRICATION
ACCESSORIES
EQUIPMENT AND PARTS
KITS
AIR BRAKE HOSE ASSY
BRASS

### Male Metric Plug



Part No.	Descr.	Prod. No.	
			"
G64790-0008	8MM-PLUG	7253-64215	M08X1.0
G64790-0010	10MM-PLUG	7253-64225	M10X1.5
G64790-0012	12MM-PLUG	7253-64235	M12X1.5
G64790-0014	14MM-PLUG	7253-64245	M14X1.5
G64790-0016	16MM-PLUG	7253-64255	M16X1.5
G64790-0018	18MM-PLUG	7253-64265	M18X1.5
G64790-0020	20MM-PLUG	7253-64275	M20X1.5
G64790-0022	22MM-PLUG	7253-64285	M22X1.5
G64790-0024	24MM-PLUG	7253-64295	M24X1.5
G64790-0026	26MM-PLUG	7253-64305	M26X1.5
G64790-0030	30MM-PLUG	7253-64315	M30X1.5

### Male DIN 24° Cone - Light Series Plug

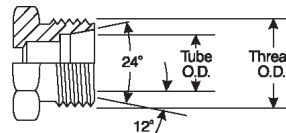

Part No.	Descr.	Prod. No.	
			"
G64792-0006	6MDL-PLUG	7253-64325	M12X1.5
G64792-0008	8MDL-PLUG	7253-64335	M14X1.5
G64792-0010	10MDL-PLUG	7253-64345	M16X1.5
G64792-0012	12MDL-PLUG	7253-64355	M18X1.5
G64792-0015	15MDL-PLUG	7253-64365	M22X1.5
G64792-0018	18MDL-PLUG	7253-64375	M26X1.5
G64792-0022	22MDL-PLUG	7253-64385	M30X2.0
G64792-0028	28MDL-PLUG	7253-64395	M36X2.0
G64792-0035	35MDL-PLUG	7253-64405	M45X2.0
G64792-0042	42MDL-PLUG	7253-64415	M52X2.0





## Female DIN 24° Cone - Light Series Cap

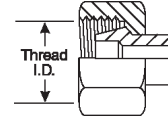
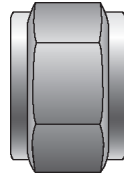

Part No.	Descr.	Prod. No.	
			"
G64793-0006	6FDL-CAP	7253-64425	M12X1.5
G64793-0008	8FDL-CAP	7253-64435	M14X1.5
G64793-0010	10FDL-CAP	7253-64445	M16X1.5
G64793-0012	12FDL-CAP	7253-64455	M18X1.5
G64793-0015	15FDL-CAP	7253-64465	M22X1.5
G64793-0018	18FDL-CAP	7253-64475	M26X1.5
G64793-0022	22FDL-CAP	7253-64485	M30X2.0
G64793-0028	28FDL-CAP	7253-64495	M36X2.0
G64793-0035	35FDL-CAP	7253-64505	M45X2.0
G64793-0042	42FDL-CAP	7253-64515	M52X2.0

## Male DIN 24° Cone - Heavy Series Plug

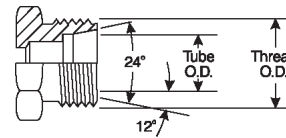



Part No.	Descr.	Prod. No.	
			"
G64794-0008	8MDH-PLUG	7253-64535	M16X1.5
G64794-0010	10MDH-PLUG	7253-64545	M18X1.5
G64794-0012	12MDH-PLUG	7253-64555	M20X1.5
G64794-0014	14MDH-PLUG	7253-64565	M22X1.5
G64794-0016	16MDH-PLUG	7253-64575	M24X1.5
G64794-0020	20MDH-PLUG	7253-64585	M30X2.0
G64794-0025	25MDH-PLUG	7253-64595	M36X2.0
G64794-0030	30MDH-PLUG	7253-64605	M42X2.0
G64794-0038	38MDH-PLUG	7253-64615	M52X2.0

- EQUIPMENT
- HOSE/CPLG. SELECTION
- G8K COUPLINGS
- GLOBALSPIRAL COUPLINGS
- STAINLESS STEEL SPIRAL
- MEGACRIMP COUPLINGS
- STAINLESS STEEL BRAID
- POWER CRIMP COUPLINGS
- FIELD ATTACHABLE G1 & G2 COUPLINGS
- FIELD ATTACHABLE C5 COUPLINGS
- C14 COUPLINGS
- GL COUPLINGS
- GLX COUPLINGS
- PCTS THERMOPLASTIC COUPLINGS
- POLARSEAL COUPLINGS (ACA)
- POLARSEAL II COUPLINGS (ACC)
- POLARSEAL II COUPLINGS (ACB)
- POWER STEERING
- ADAPTERS**
- QUICK DISCONNECT COUPLERS
- BALL VALVES
- LIVE SWIVEL
- ASSEMBLY FABRICATION
- ACCESSORIES
- EQUIPMENT AND PARTS
- KITS
- AIR BRAKE HOSE ASSY
- BRASS

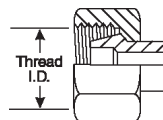
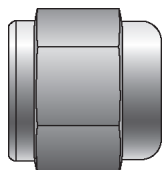

## Female DIN 24° Cone - Heavy Series Cap





Part No.	Descr.	Prod. No.	 "
G64795-0008	8FDH-CAP	7253-64635	M16X1.5
G64795-0010	10FDH-CAP	7253-64645	M18X1.5
G64795-0012	12FDH-CAP	7253-64655	M20X1.5
G64795-0014	14FDH-CAP	7253-64665	M22X1.5
G64795-0016	16FDH-CAP	7253-64675	M24X1.5
G64795-0020	20FDH-CAP	7253-64685	M30X2.0
G64795-0025	25FDH-CAP	7253-64695	M36X2.0
G64795-0030	30FDH-CAP	7253-64705	M42X2.0
G64795-0038	38FDH-CAP	7253-64715	M52X2.0

EQUIPMENT
HOSE/CPLG. SELECTION
G8K COUPLINGS
GLOBAL SPIRAL COUPLINGS
STAINLESS STEEL SPIRAL
MEGACRIMP COUPLINGS
STAINLESS STEEL BRAID
POWER CRIMP COUPLINGS
FIELD ATTACHABLE G1 & G2 COUPLINGS
FIELD ATTACHABLE C5 COUPLINGS
C14 COUPLINGS
GL COUPLINGS
GLX COUPLINGS
PCTS THERMOPLASTIC COUPLINGS
POLARSEAL COUPLINGS (ACA)
POLARSEAL II COUPLINGS (ACC)
POLARSEAL II COUPLINGS (ACB)
POWER STEERING
<b>ADAPTERS</b>
QUICK DISCONNECT COUPLERS
BALL VALVES
LIVE SWIVEL
ASSEMBLY FABRICATION
ACCESSORIES
EQUIPMENT AND PARTS
KITS
AIR BRAKE HOSE ASSY
BRASS



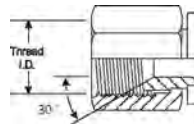
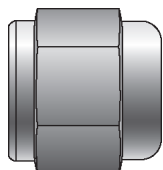

### Female Japanese Industrial Standard Cap

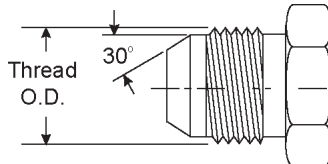
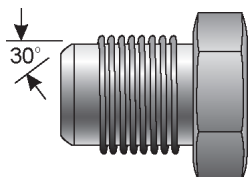

Part No.	Descr.	Prod. No.		
			"	"
G65097-0004	4FJIS-CAP	7253-64875	1/4-19	
G65097-0006	6FJIS-CAP	7253-64885	3/8-19	
G65097-0008	8FJIS-CAP	7253-64895	1/2-14	
G65097-0012	12FJIS-CAP	7253-64905	3/4-14	
G65097-0016	16FJIS-CAP	7253-64915	1-11	
G65097-0020	20FJIS-CAP	7253-64925	1 1/4-11	
G65097-0032	32FJIS-CAP	7253-64945	2-11	

### Male Japanese Industrial Standard Plug



Part No.	Descr.	Prod. No.		
			"	"
G65099-0004	4MJIS-PLUG	7253-64955	1/4-19	
G65099-0006	6MJIS-PLUG	7253-64965	3/8-19	
G65099-0008	8MJIS-PLUG	7253-64975	1/2-14	
G65099-0012	12MJIS-PLUG	7253-64985	3/4-14	
G65099-0016	16MJIS-PLUG	7253-64995	1-11	
G65099-0020	20MJIS-PLUG	7253-65005	1 1/4-11	
G65099-0024	24MJIS-PLUG	7253-65015	1 1/2-11	
G65099-0032	32MJIS-PLUG	7253-65025	2-11	

### Female Japanese Industrial Standard to Male JIC 37° Flare

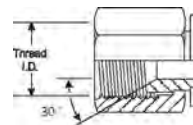
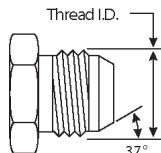
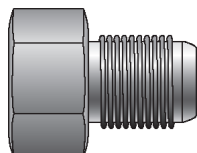

Part No.	Descr.	Prod. No.		
			"	"
G65100-0404	4FJIS-4MJ	7253-65035	1/4-19	7/16-20
G65100-0604	6FJIS-4MJ	7253-65045	3/8-19	7/16-20
G65100-0606	6FJIS-6MJ	7253-65055	3/8-19	9/16-18

- EQUIPMENT
- HOSE/CPLG. SELECTION
- G8K COUPLINGS
- GLOBALSPIRAL COUPLINGS
- STAINLESS STEEL SPIRAL
- MEGACRIMP COUPLINGS
- STAINLESS STEEL BRAID
- POWER CRIMP COUPLINGS
- FIELD ATTACHABLE G1 & G2 COUPLINGS
- FIELD ATTACHABLE C5 COUPLINGS
- C14 COUPLINGS
- GL COUPLINGS
- GLX COUPLINGS
- PCTS THERMOPLASTIC COUPLINGS
- POLARSEAL COUPLINGS (ACA)
- POLARSEAL II COUPLINGS (ACC)
- POLARSEAL II COUPLINGS (ACB)
- POWER STEERING
- ADAPTERS
- QUICK DISCONNECT COUPLERS
- BALL VALVES
- LIVE SWIVEL
- ASSEMBLY FABRICATION
- ACCESSORIES
- EQUIPMENT AND PARTS
- KITS
- AIR BRAKE HOSE ASSY
- BRASS





EQUIPMENT
HOSE/CPLG. SELECTION
G8K COUPLINGS
GLOBAL SPIRAL COUPLINGS
STAINLESS STEEL SPIRAL
MEGACRIMP COUPLINGS
STAINLESS STEEL BRAID
POWER CRIMP COUPLINGS
FIELD ATTACHABLE G1 & G2 COUPLINGS
FIELD ATTACHABLE C5 COUPLINGS
C14 COUPLINGS
GL COUPLINGS
GLX COUPLINGS
PCTS THERMOPLASTIC COUPLINGS
POLARSEAL COUPLINGS (ACA)
POLARSEAL II COUPLINGS (ACC)
POLARSEAL II COUPLINGS (ACB)
POWER STEERING
ADAPTERS
QUICK DISCONNECT COUPLERS
BALL VALVES
LIVE SWIVEL
ASSEMBLY FABRICATION
ACCESSORIES
EQUIPMENT AND PARTS
KITS
AIR BRAKE HOSE ASSY
BRASS

## Female Japanese Industrial Standard to Male JIC 37° Flare - Continued

Part No.	Descr.	Prod. No.		
			"	"
G65100-0808	8FJIS-8MJ	7253-65075	1/2-14	3/4-16
G65100-1212	12FJIS-12MJ	7253-65085	3/4-14	1 1/16-12
G65100-1616	16FJIS-16MJ	7253-65095	1-11	1 5/16-12
G65100-2020	20FJIS-20MJ	7253-65105	1 1/4-11	1 5/8-12

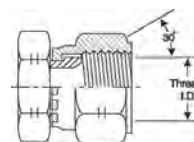
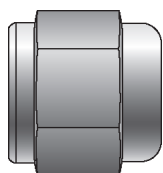
## Female Komatsu Cap



Part No.	Descr.	Prod. No.		
			"	"
G65597-0004	4FK-CAP	7253-65115	M14X1.5	
G65597-0006	6FK-CAP	7253-65125	M18X1.5	
G65597-0008	8FK-CAP	7253-65135	M22X1.5	
G65597-0010	10FK-CAP	7253-65145	M24X1.5	
G65597-0012	12FK-CAP	7253-65155	M30X1.5	
G65597-0016	16FK-CAP	7253-65165	M33X1.5	

## Male Komatsu Plug

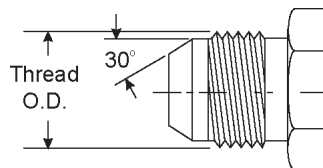
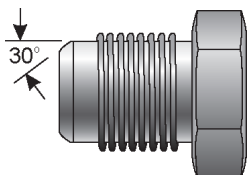

Part No.	Descr.	Prod. No.		
			"	"
G65599-0004	4MK-PLUG	7253-65175	M14X1.5	
G65599-0006	6MK-PLUG	7253-65185	M18X1.5	
G65599-0008	8MK-PLUG	7253-65195	M22X1.5	
G65599-0010	10MK-PLUG	7253-65205	M24X1.5	
G65599-0012	12MK-PLUG	7253-65215	M30X1.5	
G65599-0016	16MK-PLUG	7253-65225	M33X1.5	



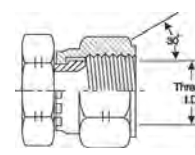
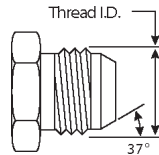
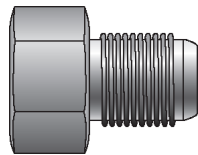

### Female Komatsu to Male JIC 37° Flare

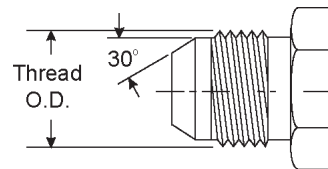
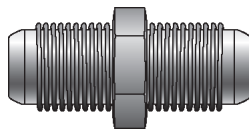

Part No.	Descr.	Prod. No.		
			"	"
G65600-0404	4FK-4MJ	7253-65235	M14X1.5	7/16-20
G65600-0606	6FK-6MJ	7253-65245	M18X1.5	9/16-18
G65600-0808	8FK-8MJ	7253-65255	M22X1.5	3/4-16
G65600-1010	10FK-10MJ	7253-65265	M24X1.5	7/8-14
G65600-1212	12FK-12MJ	7253-65275	M30X1.5	1 1/16-12
G65600-1616	16FK-16MJ	7253-65285	M33X1.5	1 5/16-12

### Male Komatsu to Male Komatsu



Part No.	Descr.	Prod. No.		
			"	"
G65700-0404	4MK-4MK	7253-65765	M14X1.5	M14X1.5
G65700-0606	6MK-6MK	7253-65775	M18X1.5	M18X1.5
G65700-0808	8MK-8MK	7253-65785	M22X1.5	M22X1.5
G65700-1010	10MK-10MK	7253-65795	M24X1.5	M24X1.5
G65700-1212	12MK-12MK	7253-65805	M30X1.5	M30X1.5
G65700-1616	16MK-16MK	7253-65815	M33X1.5	M33X1.5

### Male Komatsu to Male JIC 37° Flare

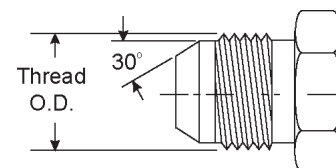
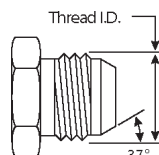
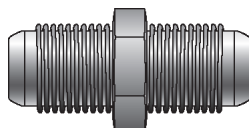

Part No.	Descr.	Prod. No.		
			"	"
G65750-0404	4MK-4MJ	7253-65825	M14X1.5	7/16-20
G65750-0606	6MK-6MJ	7253-65835	M18X1.5	9/16-18
G65750-0808	8MK-8MJ	7253-65845	M22X1.5	3/4-16
G65750-1010	10MK-10MJ	7253-65855	M24X1.5	7/8-14
G65750-1212	12MK-12MJ	7253-65865	M30X1.5	1 1/16-12
G65750-1616	16MK-16MJ	7253-65875	M33X1.5	1 5/16-12

EQUIPMENT
HOSE/CPLG. SELECTION
G8K COUPLINGS
GLOBALSPIRAL COUPLINGS
STAINLESS STEEL SPIRAL
MEGACRIMP COUPLINGS
STAINLESS STEEL BRAID
POWER CRIMP COUPLINGS
FIELD ATTACHABLE G1 & G2 COUPLINGS
FIELD ATTACHABLE C5 COUPLINGS
C14 COUPLINGS
GL COUPLINGS
GLX COUPLINGS
PCTS THERMOPLASTIC COUPLINGS
POLARSEAL COUPLINGS (ACA)
POLARSEAL II COUPLINGS (ACC)
POLARSEAL II COUPLINGS (ACB)
POWER STEERING
ADAPTERS
QUICK DISCONNECT COUPLERS
BALL VALVES
LIVE SWIVEL
ASSEMBLY FABRICATION
ACCESSORIES
EQUIPMENT AND PARTS
KITS
AIR BRAKE HOSE ASSY
BRASS



EQUIPMENT
HOSE/CPLG. SELECTION
G8K COUPLINGS
GLOBAL SPIRAL COUPLINGS
STAINLESS STEEL SPIRAL
MEGACRIMP COUPLINGS
STAINLESS STEEL BRAID
POWER CRIMP COUPLINGS
FIELD ATTACHABLE G1 & G2 COUPLINGS
FIELD ATTACHABLE C5 COUPLINGS
C14 COUPLINGS
GL COUPLINGS
GLX COUPLINGS
PCTS THERMOPLASTIC COUPLINGS
POLARSEAL COUPLINGS (ACA)
POLARSEAL II COUPLINGS (ACC)
POLARSEAL II COUPLINGS (ACB)
POWER STEERING
ADAPTERS
QUICK DISCONNECT COUPLERS
BALL VALVES
LIVE SWIVEL
ASSEMBLY FABRICATION
ACCESSORIES
EQUIPMENT AND PARTS
KITS
AIR BRAKE HOSE ASSY
BRASS

### Male Komatsu to Female Komatsu - 90°

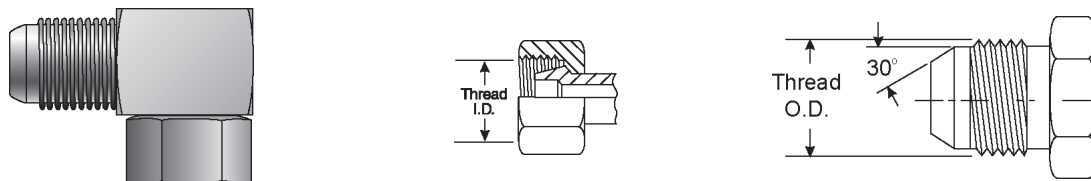

Part No.	Descr.	Prod. No.	Thread	
			"	"
G65800-0404	4MK-4FK90	7253-65945	M14X1.5	M14X1.5
G65800-0606	6MK-6FK90	7253-65965	M18X1.5	M18X1.5
G65800-0808	8MK-8FK90	7253-65975	M22X1.5	M22X1.5
G65800-1010	10MK-10FK90	7253-65985	M24X1.5	M24X1.5
G65800-1212	12MK-12FK90	7253-65995	M30X1.5	M30X1.5
G65800-1616	16MK-16FK90	7253-66005	M33X1.5	M33X1.5

### Male Komatsu to Female Komatsu to Male Komatsu - Tee

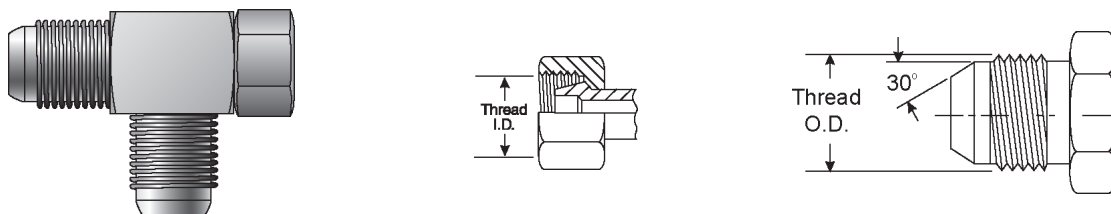

Part No.	Descr.	Prod. No.	Thread		
			"	"	"
G65950-0404	4MK-4FK-4MK	7253-65885	M14X1.5	M14X1.5	M14X1.5
G65950-0606	6MK-6FK-6MK	7253-65905	M18X1.5	M18X1.5	M18X1.5
G65950-0808	8MK-8FK-8MK	7253-65915	M22X1.5	M22X1.5	M22X1.5
G65950-1010	10MK-10FK-10MK	7253-65925	M24X1.5	M24X1.5	M24X1.5
G65950-1212	12MK-12FK-12MK	7253-65935	M30X1.5	M30X1.5	M30X1.5



### Bite Sleeve



Part No.	Descr.	Prod. No.
G73050-0003	3ERBS	7259-90025
G73050-0004	4ERBS	7259-90035
G73050-0006	6ERBS	7259-90055
G73050-0008	8ERBS	7259-90065

### Tube Sleeve Nut



Part No.	Descr.	Prod. No.
G73060-0006	6ERTSN	7259-90165

### Ermeto to Male Pipe



Part No.	Descr.	Prod. No.	
			"
G73100-0402	4ERT-2MP	7259-90505	1/8-27
G73100-0404	4ERT-4MP	7259-90515	1/4-18

- EQUIPMENT
- HOSE/CPLG. SELECTION
- G8K COUPLINGS
- GLOBALSPIRAL COUPLINGS
- STAINLESS STEEL SPIRAL
- MEGACRIMP COUPLINGS
- STAINLESS STEEL BRAID
- POWER CRIMP COUPLINGS
- FIELD ATTACHABLE G1 & G2 COUPLINGS
- FIELD ATTACHABLE C5 COUPLINGS
- C14 COUPLINGS
- GL COUPLINGS
- GLX COUPLINGS
- PCTS THERMOPLASTIC COUPLINGS
- POLARSEAL COUPLINGS (ACA)
- POLARSEAL II COUPLINGS (ACC)
- POLARSEAL II COUPLINGS (ACB)
- POWER STEERING
- ADAPTERS**
- QUICK DISCONNECT COUPLERS
- BALL VALVES
- LIVE SWIVEL
- ASSEMBLY FABRICATION
- ACCESSORIES
- EQUIPMENT AND PARTS
- KITS
- AIR BRAKE HOSE ASSY
- BRASS



EQUIPMENT
HOSE/CPLG. SELECTION
G8K COUPLINGS
GLOBAL SPIRAL COUPLINGS
STAINLESS STEEL SPIRAL
MEGACRIMP COUPLINGS
STAINLESS STEEL BRAID
POWER CRIMP COUPLINGS
FIELD ATTACHABLE G1 & G2 COUPLINGS
FIELD ATTACHABLE C5 COUPLINGS
C14 COUPLINGS
GL COUPLINGS
GLX COUPLINGS
PCTS THERMOPLASTIC COUPLINGS
POLARSEAL COUPLINGS (ACA)
POLARSEAL II COUPLINGS (ACC)
POLARSEAL II COUPLINGS (ACB)
POWER STEERING
<b>ADAPTERS</b>
QUICK DISCONNECT COUPLERS
BALL VALVES
LIVE SWIVEL
ASSEMBLY FABRICATION
ACCESSORIES
EQUIPMENT AND PARTS
KITS
AIR BRAKE HOSE ASSY
BRASS

### Ermeto to Male Pipe - 90°

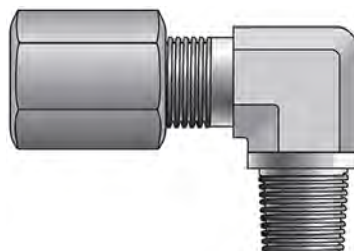

Part No.	Descr.	Prod. No.	⌀	
			"	mm
G73104-0402	4ERT-2MP90	7259-90975	1/8	27

### Ermeto to Ermeto

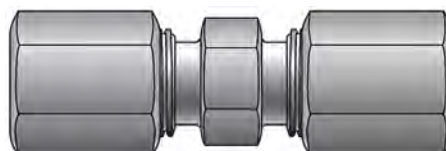

Part No.	Descr.	Prod. No.	⌀	
			"	mm
G73400-0303	3ERT-3ERT	7259-90375	3/16	4.8
G73400-0404	4ERT-4ERT	7259-90385	1/4	6.4
G73400-0505	5ERT-5ERT	7259-90395	5/16	7.9
G73400-0606	6ERT-6ERT	7259-90405	3/8	9.5
G73400-0808	8ERT-8ERT	7259-90415	1/2	12.7
G73400-1010	10ERT-10ERT	7259-90425	5/8	15.9





### Male Ball Valve to Female Pipe

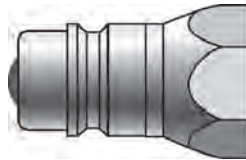

Part No.	Descr.	Prod. No.			
			"		
G94011-0404	4MQBA-4FP	7252-89315	1/4-18	4000	12000
G94011-0606	6MQBA-6FP	7252-89345	3/8-18	3000	9000
G94011-0808	8MQBA-8FP	7252-89325	1/2-14	3000	10500
G94011-0812	8MQBA-12FP	7252-89305	3/4-14	3000	10500
G94011-1212	12MQBA-12FP	7252-89685	3/4-14	4000	11000

### Male Ball Valve to Female O-Ring Boss

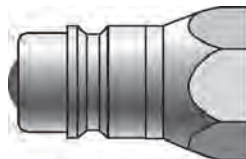

Part No.	Descr.	Prod. No.			
			"		
G94012-0808	8MQBA-8FB	7252-89335	3/4-16	3000	10500

### Female Ball Valve To Female Pipe

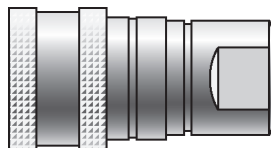

Part No.	Descr.	Prod. No.			
			"		
G94021-0404	4FQBA-4FP	7252-89415	1/4-18	4000	12000
G94021-0606D	6FQBADA-6FP*	7252-89695	3/8-18	3000	9000
G94021-0808D	8FQBADA-8FP*	7252-89445	1/2-14	3000	10500
G94021-0808	8FQBA-8FP	7252-89425	1/2-14	3000	10500
G94021-0812D	8FQBADA-12FP*	7252-89705	3/4-14	3000	10500
G94021-1212	12FQBA-12FP	7252-89715	3/4-14	4000	11000

\*Double-Acting Sleeve

- EQUIPMENT
- HOSE/CPLG. SELECTION
- G8K COUPLINGS
- GLOBALSPIRAL COUPLINGS
- STAINLESS STEEL SPIRAL
- MEGACRIMP COUPLINGS
- STAINLESS STEEL BRAID
- POWER CRIMP COUPLINGS
- FIELD ATTACHABLE G1 & G2 COUPLINGS
- FIELD ATTACHABLE C5 COUPLINGS
- C14 COUPLINGS
- GL COUPLINGS
- GLX COUPLINGS
- PCTS THERMOPLASTIC COUPLINGS
- POLARSEAL COUPLINGS (ACA)
- POLARSEAL II COUPLINGS (ACC)
- POLARSEAL II COUPLINGS (ACB)
- POWER STEERING
- ADAPTERS
- QUICK DISCONNECT COUPLERS
- BALL VALVES
- LIVE SWIVEL
- ASSEMBLY FABRICATION
- ACCESSORIES
- EQUIPMENT AND PARTS
- KITS
- AIR BRAKE HOSE ASSY
- BRASS



EQUIPMENT
HOSE/CPLG. SELECTION
G8K COUPLINGS
GLOBAL SPIRAL COUPLINGS
STAINLESS STEEL SPIRAL
MEGACRIMP COUPLINGS
STAINLESS STEEL BRAID
POWER CRIMP COUPLINGS
FIELD ATTACHABLE G1 & G2 COUPLINGS
FIELD ATTACHABLE C5 COUPLINGS
C14 COUPLINGS
GL COUPLINGS
GLX COUPLINGS
PCTS THERMOPLASTIC COUPLINGS
POLARSEAL COUPLINGS (ACA)
POLARSEAL II COUPLINGS (ACC)
POLARSEAL II COUPLINGS (ACB)
POWER STEERING
ADAPTERS
QUICK DISCONNECT COUPLERS
BALL VALVES
LIVE SWIVEL
ASSEMBLY FABRICATION
ACCESSORIES
EQUIPMENT AND PARTS
KITS
AIR BRAKE HOSE ASSY
BRASS

## Female Ball Valve To Female O-Ring Boss

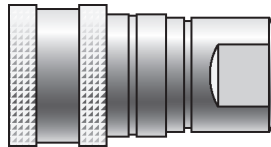

Part No.	Descr.	Prod. No.			
			"		
G94022-0808	8FQBA-8FB	7252-89435	3/4-16	3000	10500

## O-Ring



Part No.	Descr.	Prod. No.
G94025-0004	4QDAOR	7252-59415
G94025-0006	6QDAOR	7252-59695
G94025-0008	8QDAOR	7252-59425
G94025-0012	12QDAOR	7252-59715



### QD Dust Plug



Part No.	Descr.	Prod. No.
G94080-0004	4QDADP	7252-89465
G94080-0006	6QDADP	7252-89485
G94080-0008	8QDADP	7252-89475

### QD Dust Cap



Part No.	Descr.	Prod. No.
G94090-0004	4QDADC	7252-89565
G94090-0006	6QDADC	7252-89585
G94090-0008	8QDADC	7252-89575

- EQUIPMENT
- HOSE/CPLG. SELECTION
- G8K COUPLINGS
- GLOBALSPIRAL COUPLINGS
- STAINLESS STEEL SPIRAL
- MEGACRIMP COUPLINGS
- STAINLESS STEEL BRAID
- POWER CRIMP COUPLINGS
- FIELD ATTACHABLE G1 & G2 COUPLINGS
- FIELD ATTACHABLE C5 COUPLINGS
- C14 COUPLINGS
- GL COUPLINGS
- GLX COUPLINGS
- PCTS THERMOPLASTIC COUPLINGS
- POLARSEAL COUPLINGS (ACA)
- POLARSEAL II COUPLINGS (ACC)
- POLARSEAL II COUPLINGS (ACB)
- POWER STEERING
- ADAPTERS
- QUICK DISCONNECT COUPLERS
- BALL VALVES
- LIVE SWIVEL
- ASSEMBLY FABRICATION
- ACCESSORIES
- EQUIPMENT AND PARTS
- KITS
- AIR BRAKE HOSE ASSY
- BRASS



EQUIPMENT
HOSE/CPLG. SELECTION
G8K COUPLINGS
GLOBAL SPIRAL COUPLINGS
STAINLESS STEEL SPIRAL
MEGACRIMP COUPLINGS
STAINLESS STEEL BRAID
POWER CRIMP COUPLINGS
FIELD ATTACHABLE G1 & G2 COUPLINGS
FIELD ATTACHABLE C5 COUPLINGS
C14 COUPLINGS
GL COUPLINGS
GLX COUPLINGS
PCTS THERMOPLASTIC COUPLINGS
POLARSEAL COUPLINGS (ACA)
POLARSEAL II COUPLINGS (ACC)
POLARSEAL II COUPLINGS (ACB)
POWER STEERING
ADAPTERS
QUICK DISCONNECT COUPLERS
BALL VALVES
LIVE SWIVEL
ASSEMBLY FABRICATION
ACCESSORIES
EQUIPMENT AND PARTS
KITS
AIR BRAKE HOSE ASSY
BRASS

### Male Poppet Valve to Female Pipe

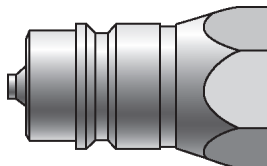

Part No.	Descr.	Prod. No.			
			"		
G94111-0404	4MQPA-4FP	7252-89725	1/4-18	3000	12000
G94111-0606	6MQPA-6FP	7252-89735	3/8-18	3000	12000
G94111-0808	8MQPA-8FP	7252-89365	1/2-14	4000	16000
G94111-1616	16MQPA-16FP	7252-89745	1-11 1/2	3000	12000

### Female Poppet Valve to Female Pipe

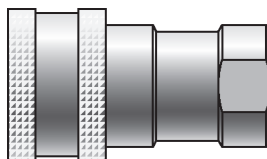

Part No.	Descr.	Prod. No.			
			"		
G94121-0404	4FQPA-4FP	7252-89755	1/4-18	3000	12000
G94121-0606	6FQPA-6FP	7252-89765	3/8-18	3000	12000
G94121-0808	8FQPA-8FP	7252-89775	1/2-14	4000	16000
G94121-1616	16FQPA-16FP	7252-89785	1-11 1/2	3000	12000



### Male Ball Valve to Female Pipe

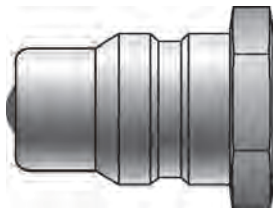

Part No.	Descr.	Prod. No.		
			"	
G94211-0808	8MQBAJD-8FP	7252-89355	1/2-14	3000

### Male Ball Valve to Female O-Ring Boss

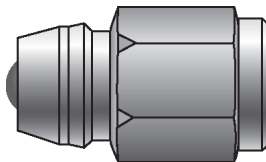

Part No.	Descr.	Prod. No.		
			"	
G94212-0808	8MQBAJD-8FB	7252-89375	3/4-16	3000

### Female Ball Valve to Female Pipe

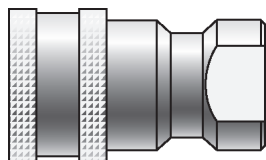

Part No.	Descr.	Prod. No.		
			"	
G94221-0808	8FQBAJD-8FP	7252-89455	1/2-14	3000

- EQUIPMENT
- HOSE/CPLG. SELECTION
- G8K COUPLINGS
- GLOBALSPIRAL COUPLINGS
- STAINLESS STEEL SPIRAL
- MEGACRIMP COUPLINGS
- STAINLESS STEEL BRAID
- POWER CRIMP COUPLINGS
- FIELD ATTACHABLE G1 & G2 COUPLINGS
- FIELD ATTACHABLE C5 COUPLINGS
- C14 COUPLINGS
- GL COUPLINGS
- GLX COUPLINGS
- PCTS THERMOPLASTIC COUPLINGS
- POLARSEAL COUPLINGS (ACA)
- POLARSEAL II COUPLINGS (ACC)
- POLARSEAL II COUPLINGS (ACB)
- POWER STEERING
- ADAPTERS
- QUICK DISCONNECT COUPLERS
- BALL VALVES
- LIVE SWIVEL
- ASSEMBLY FABRICATION
- ACCESSORIES
- EQUIPMENT AND PARTS
- KITS
- AIR BRAKE HOSE ASSY
- BRASS



### Male Tip - Ball Valve to Female Pipe

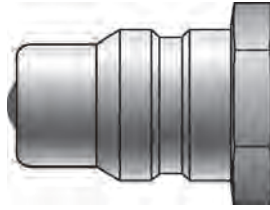



EQUIPMENT
HOSE/CPLG. SELECTION
G8K COUPLINGS
GLOBAL SPIRAL COUPLINGS
STAINLESS STEEL SPIRAL
MEGACRIMP COUPLINGS
STAINLESS STEEL BRAID
POWER CRIMP COUPLINGS
FIELD ATTACHABLE G1 & G2 COUPLINGS
FIELD ATTACHABLE C5 COUPLINGS
C14 COUPLINGS
GL COUPLINGS
GLX COUPLINGS
PCTS THERMOPLASTIC COUPLINGS
POLARSEAL COUPLINGS (ACA)
POLARSEAL II COUPLINGS (ACC)
POLARSEAL II COUPLINGS (ACB)
POWER STEERING
ADAPTERS
QUICK DISCONNECT COUPLERS
BALL VALVES
LIVE SWIVEL
ASSEMBLY FABRICATION
ACCESSORIES
EQUIPMENT AND PARTS
KITS
AIR BRAKE HOSE ASSY
BRASS

Part No.	Descr.	Prod. No.		
			"	
G94311-0808	8MQBAIHC-8FP	7252-89385	1/2-14	2500

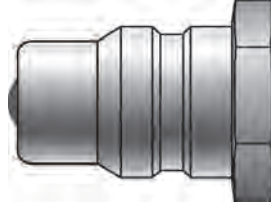

### Male Tip - Ball Valve to Female Pipe



Part No.	Descr.	Prod. No.		
			"	
G94411-0808	8MQBAJIC-8FP	7252-89395	1/2-14	3000

EQUIPMENT
HOSE/CPLG. SELECTION
G8K COUPLINGS
GLOBALSPIRAL COUPLINGS
STAINLESS STEEL SPIRAL
MEGACRIMP COUPLINGS
STAINLESS STEEL BRAID
POWER CRIMP COUPLINGS
FIELD ATTACHABLE G1 & G2 COUPLINGS
FIELD ATTACHABLE C5 COUPLINGS
C14 COUPLINGS
GL COUPLINGS
GLX COUPLINGS
PCTS THERMOPLASTIC COUPLINGS
POLARSEAL COUPLINGS (ACA)
POLARSEAL II COUPLINGS (ACC)
POLARSEAL II COUPLINGS (ACB)
POWER STEERING
ADAPTERS
QUICK DISCONNECT COUPLERS
BALL VALVES
LIVE SWIVEL
ASSEMBLY FABRICATION
ACCESSORIES
EQUIPMENT AND PARTS
KITS
AIR BRAKE HOSE ASSY
BRASS



EQUIPMENT
HOSE/CPLG. SELECTION
G8K COUPLINGS
GLOBAL SPIRAL COUPLINGS
STAINLESS STEEL SPIRAL
MEGACRIMP COUPLINGS
STAINLESS STEEL BRAID
POWER CRIMP COUPLINGS
FIELD ATTACHABLE G1 & G2 COUPLINGS
FIELD ATTACHABLE C5 COUPLINGS
C14 COUPLINGS
GL COUPLINGS
GLX COUPLINGS
PCTS THERMOPLASTIC COUPLINGS
POLARSEAL COUPLINGS (ACA)
POLARSEAL II COUPLINGS (ACC)
POLARSEAL II COUPLINGS (ACB)
POWER STEERING
ADAPTERS
QUICK DISCONNECT COUPLERS
BALL VALVES
LIVE SWIVEL
ASSEMBLY FABRICATION
ACCESSORIES
EQUIPMENT AND PARTS
KITS
AIR BRAKE HOSE ASSY
BRASS

## Male Poppet Valve to Female Pipe

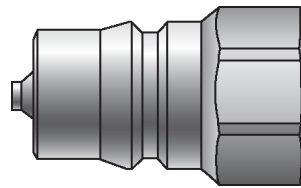

Part No.	Descr.	Prod. No.			
			"		
G94511-0404	4MQPI-4FP	7252-89015	1/4-18	7500	30000
G94511-0606	6MQPI-6FP	7252-89025	3/8-18	5000	20000
G94511-0808	8MQPI-8FP	7252-89035	1/2-14	5000	20000
G94511-1212	12MQPI-12FP	7252-89045	3/4-14	4000	16000
G94511-1616	16MQPI-16FP	7252-89055	1-11 1/2	4000	16000

## Female Poppet Valve to Female Pipe

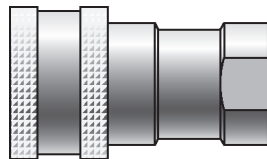

Part No.	Descr.	Prod. No.			
			"		
G94521-0404	4FQPI-4FP	7252-89115	1/4-18	7500	30000
G94521-0606	6FQPI-6FP	7252-89125	3/8-18	5000	20000
G94521-0808	8FQPI-8FP	7252-89135	1/2-14	5000	20000
G94521-1212	12FQPI-12FP	7252-89145	3/4-14	4000	16000
G94521-1616	16FQPI-16FP	7252-89155	1-11 1/2	4000	16000

## O-Ring

90 Durometer Hardness.

Caution: DO NOT USE these O-Rings with phosphate esters, diesters or phosphate ester emulsion hydraulic fluids. Instead, use O-Rings made of Viton, EPDM or CPE polymers or other materials compatible with the fluids. These O-Rings are compounded from a Nitrile polymer for use with petroleum-based hydraulic fluids, water and glycol and oil-water emulsions.



Part No.	Descr.	Prod. No.
G94525-0004	4QDIOR	7252-59115
G94525-0006	6QDIOR	7252-59125
G94525-0008	8QDIOR	7252-59135





## O-Ring - Continued

Part No.	Descr.	Prod. No.
G94525-0012	12QDIOR	7252-59145
G94525-0016	16QDIOR	7252-59155

## Backup Ring



Part No.	Descr.	Prod. No.
G94526-0004	4QDIBR	7252-49115
G94526-0006	6QDIBR	7252-49125
G94526-0008	8QDIBR	7252-49135
G94526-0012	12QDIBR	7252-49145
G94526-0016	16QDIBR	7252-49155

## QD Plug - Cap Combination



Part No.	Descr.	Prod. No.
G94581-0004	4QDIDP/C	7252-87005
G94581-0006	6QDIDP/C	7252-87595
G94581-0008	8QDIDP/C	7252-87605
G94581-0012	12QDIDP/C	7252-87615
G94581-0016	16QDIDP/C	7252-87625

EQUIPMENT
HOSE/CPLG. SELECTION
G8K COUPLINGS
GLOBALSPIRAL COUPLINGS
STAINLESS STEEL SPIRAL
MEGACRIMP COUPLINGS
STAINLESS STEEL BRAID
POWER CRIMP COUPLINGS
FIELD ATTACHABLE G1 & G2 COUPLINGS
FIELD ATTACHABLE C5 COUPLINGS
C14 COUPLINGS
GL COUPLINGS
GLX COUPLINGS
PCTS THERMOPLASTIC COUPLINGS
POLARSEAL COUPLINGS (ACA)
POLARSEAL II COUPLINGS (ACC)
POLARSEAL II COUPLINGS (ACB)
POWER STEERING
ADAPTERS
QUICK DISCONNECT COUPLERS
BALL VALVES
LIVE SWIVEL
ASSEMBLY FABRICATION
ACCESSORIES
EQUIPMENT AND PARTS
KITS
AIR BRAKE HOSE ASSY
BRASS



EQUIPMENT
HOSE/CPLG. SELECTION
G8K COUPLINGS
GLOBAL SPIRAL COUPLINGS
STAINLESS STEEL SPIRAL
MEGACRIMP COUPLINGS
STAINLESS STEEL BRAID
POWER CRIMP COUPLINGS
FIELD ATTACHABLE G1 & G2 COUPLINGS
FIELD ATTACHABLE C5 COUPLINGS
C14 COUPLINGS
GL COUPLINGS
GLX COUPLINGS
PCTS THERMOPLASTIC COUPLINGS
POLARSEAL COUPLINGS (ACA)
POLARSEAL II COUPLINGS (ACC)
POLARSEAL II COUPLINGS (ACB)
POWER STEERING
ADAPTERS
QUICK DISCONNECT COUPLERS
BALL VALVES
LIVE SWIVEL
ASSEMBLY FABRICATION
ACCESSORIES
EQUIPMENT AND PARTS
KITS
AIR BRAKE HOSE ASSY
BRASS

## Male Flush Face Valve to Female Pipe

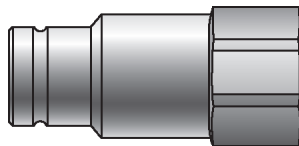

Part No.	Descr.	Prod. No.			
			"		
G94911-0404	4MQFF-4FP	7252-87015	1/4-18	3000	12000
G94911-0606	6MQFF-6FP	7252-88005	3/8-18	3000	12000
G94911-0608	6MQFF-8FP	7252-88015	1/2-14	3000	12000
G94911-0808	8MQFF-8FP	7252-87025	1/2-14	3000	12000
G94911-0808P	8CPMQFF-8FP*	7252-87435	1/2-14	3000	12000
G94911-1212	12MQFF-12FP	7252-87035	3/4-14	3000	12000
G94911-1616	16MQFF-16FP	7252-87045	1-11 1/2	3000	12000

\*Connect-under-pressure coupler.

## Male Flush Face Valve to Female O-Ring Boss

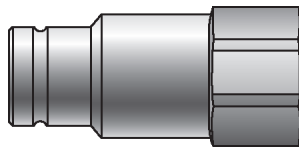

Part No.	Descr.	Prod. No.			
			"		
G94912-0404	4MQFF-4FB	7252-87055	7/16-20	3000	12000
G94912-0608	6MQFF-8FB	7252-88025	3/4-16	3000	12000
G94912-0808	8MQFF-8FB	7252-87065	3/4-16	3000	12000
G94912-0808P	8CPMQFF-8FB*	7252-87445	3/4-16	3000	12000
G94912-0810P	8CPMQFF-10FB*	7252-87455	7/8-14	3000	12000
G94912-0812	8MQFF-12FB	7252-87075	1 1/16-12	3000	12000
G94912-0812P	8CPMQFF-12FB*	7252-87465	1 1/16-12	3000	12000
G94912-1012	10MQFF-12FB	7252-87085	1 1/16-12	3000	12000
G94912-1212	12MQFF-12FB	7252-87095	1 1/16-12	3000	12000
G94912-1616	16MQFF-16FB	7252-87105	1 5/16-12	3000	12000

\*Connect-under-pressure coupler.



### Male Flush Face Valve to JIC 37° Flare Bulkhead

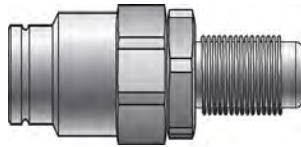

Part No.	Descr.	Prod. No.			
			"		
G94913-0810	8MQFF-10BKHD	7252-87395	7/8-14	3625	14500
G94913-1012	10MQFF-12BKHD	7252-87405	1 1/16-12	3625	14500

### Male Flush Face Valve to Female British Pipe Parallel

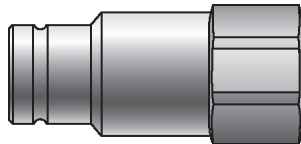

Part No.	Descr.	Prod. No.			
			"		
G94915-0404	4MQFF-4FBPP	7252-87115	1/4-19	4568	18270
G94915-0808	8MQFF-8FBPP	7252-87125	1/2-14	3625	14500
G94915-1212	12MQFF-12FBPP	7252-87135	3/4-14	3625	14500
G94915-1616	16MQFF-16FBPP	7252-87145	1-11	2900	11600

### Female Flush Face Valve to Female Pipe

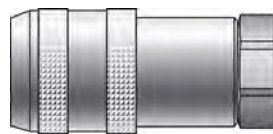

Part No.	Descr.	Prod. No.			
			"		
G94921-0404	4FQFF-4FP	7252-87155	1/4-18	3000	12000
G94921-0606	6FQFF-6FP	7252-88035	3/8-18	3000	12000
G94921-0608	6FQFF-8FP	7252-88045	1/2-14	3000	12000
G94921-0808	8FQFF-8FP	7252-87165	1/2-14	3000	12000
G94921-0808P	8CPFQFF-8FP*	7252-87475	1/2-14	3000	12000
G94921-1212	12FQFF-12FP	7252-87175	3/4-14	3000	12000
G94921-1616	16FQFF-16FP	7252-87185	1-11 1/2	3000	12000

\*Connect-under-pressure coupler.

- EQUIPMENT
- HOSE/CPLG. SELECTION
- G8K COUPLINGS
- GLOBALSPIRAL COUPLINGS
- STAINLESS STEEL SPIRAL
- MEGACRIMP COUPLINGS
- STAINLESS STEEL BRAID
- POWER CRIMP COUPLINGS
- FIELD ATTACHABLE G1 & G2 COUPLINGS
- FIELD ATTACHABLE C5 COUPLINGS
- C14 COUPLINGS
- GL COUPLINGS
- GLX COUPLINGS
- PCTS THERMOPLASTIC COUPLINGS
- POLARSEAL COUPLINGS (ACA)
- POLARSEAL II COUPLINGS (ACC)
- POLARSEAL II COUPLINGS (ACB)
- POWER STEERING
- ADAPTERS
- QUICK DISCONNECT COUPLERS
- BALL VALVES
- LIVE SWIVEL
- ASSEMBLY FABRICATION
- ACCESSORIES
- EQUIPMENT AND PARTS
- KITS
- AIR BRAKE HOSE ASSY
- BRASS



EQUIPMENT
HOSE/CPLG. SELECTION
G8K COUPLINGS
GLOBAL SPIRAL COUPLINGS
STAINLESS STEEL SPIRAL
MEGACRIMP COUPLINGS
STAINLESS STEEL BRAID
POWER CRIMP COUPLINGS
FIELD ATTACHABLE G1 & G2 COUPLINGS
FIELD ATTACHABLE C5 COUPLINGS
C14 COUPLINGS
GL COUPLINGS
GLX COUPLINGS
PCTS THERMOPLASTIC COUPLINGS
POLARSEAL COUPLINGS (ACA)
POLARSEAL II COUPLINGS (ACC)
POLARSEAL II COUPLINGS (ACB)
POWER STEERING
ADAPTERS
QUICK DISCONNECT COUPLERS
BALL VALVES
LIVE SWIVEL
ASSEMBLY FABRICATION
ACCESSORIES
EQUIPMENT AND PARTS
KITS
AIR BRAKE HOSE ASSY
BRASS

## Female Flush Face Valve to Female O-Ring Boss

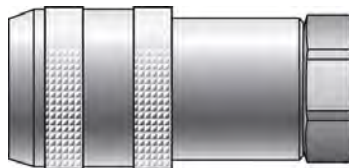

Part No.	Descr.	Prod. No.			
			"		
G94922-0404	4FQFF-4FB	7252-87195	7/16-20	3000	12000
G94922-0608	6FQFF-8FB	7252-88055	3/4-16	3000	12000
G94922-0808	8FQFF-8FB	7252-87205	3/4-16	3000	12000
G94922-0808P	8CPFQFF-8FB*	7252-87485	3/4-16	3000	12000
G94922-0810P	8CPFQFF-10FB*	7252-87495	7/8-14	3000	12000
G94922-0812	8FQFF-12FB	7252-87215	1 1/16-12	3000	12000
G94922-0812P	8CPFQFF-12FB*	7252-87505	1 1/16-12	3000	12000
G94922-1012	10FQFF-12FB	7252-87225	1 1/16-12	3000	12000
G94922-1212	12FQFF-12FB	7252-87235	1 1/16-12	3000	12000
G94922-1616	16FQFF-16FB	7252-87245	1 5/16-12	3000	12000

\*Connect-under-pressure coupler.

## Female Flush Face to JIC 37° Flare Bulkhead

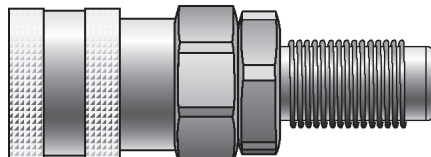

Part No.	Descr.	Prod. No.			
			"		
G94923-0810	8FQFF-10BKHD	7252-87415	7/8-14	3625	14500
G94923-1012	10FQFF-12BKHD	7252-87425	1 1/16-12	3625	14500

## Female Flush Face Valve to Female British Pipe Parallel

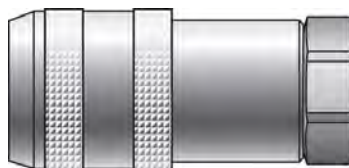

Part No.	Descr.	Prod. No.			
			"		
G94925-0808	8FQFF-8FBPP	7252-87265	1/2-14	3625	14500
G94925-1212	12FQFF-12FBPP	7252-87275	3/4-14	3625	14500
G94925-1616	16FQFF-16FBPP	7252-87285	1-11	2900	11600



### Dust Plug



Part No.	Descr.	Prod. No.
G94980-0004	4QDFFDP	7252-87295
G94980-0006	6QDFFDP	7252-88065
G94980-0008	8QDFFDP	7252-87305
G94980-0010	10QDFFDP	7252-87315
G94980-0012	12QDFFDP	7252-87325
G94980-0016	16QDFFDP	7252-87335

### Dust Cap



Part No.	Descr.	Prod. No.
G94990-0004	4QDFFDC	7252-87345
G94990-0006	6QDFFDC	7252-88075
G94990-0008	8QDFFDC	7252-87355
G94990-0010	10QDFFDC	7252-87365
G94990-0012	12QDFFDC	7252-87375
G94990-0016	16QDFFDC	7252-87385

- EQUIPMENT
- HOSE/CPLG. SELECTION
- G8K COUPLINGS
- GLOBAL SPIRAL COUPLINGS
- STAINLESS STEEL SPIRAL
- MEGACRIMP COUPLINGS
- STAINLESS STEEL BRAID
- POWER CRIMP COUPLINGS
- FIELD ATTACHABLE G1 & G2 COUPLINGS
- FIELD ATTACHABLE C5 COUPLINGS
- C14 COUPLINGS
- GL COUPLINGS
- GLX COUPLINGS
- PCTS THERMOPLASTIC COUPLINGS
- POLARSEAL COUPLINGS (ACA)
- POLARSEAL II COUPLINGS (ACC)
- POLARSEAL II COUPLINGS (ACB)
- POWER STEERING
- ADAPTERS
- QUICK DISCONNECT COUPLERS
- BALL VALVES
- LIVE SWIVEL
- ASSEMBLY FABRICATION
- ACCESSORIES
- EQUIPMENT AND PARTS
- KITS
- AIR BRAKE HOSE ASSY
- BRASS



EQUIPMENT
HOSE/CPLG. SELECTION
G8K COUPLINGS
GLOBAL SPIRAL COUPLINGS
STAINLESS STEEL SPIRAL
MEGACRIMP COUPLINGS
STAINLESS STEEL BRAID
POWER CRIMP COUPLINGS
FIELD ATTACHABLE G1 & G2 COUPLINGS
FIELD ATTACHABLE C5 COUPLINGS
C14 COUPLINGS
GL COUPLINGS
GLX COUPLINGS
PCTS THERMOPLASTIC COUPLINGS
POLARSEAL COUPLINGS (ACA)
POLARSEAL II COUPLINGS (ACC)
POLARSEAL II COUPLINGS (ACB)
POWER STEERING
ADAPTERS
QUICK DISCONNECT COUPLERS
BALL VALVES
LIVE SWIVEL
ASSEMBLY FABRICATION
ACCESSORIES
EQUIPMENT AND PARTS
KITS
AIR BRAKE HOSE ASSY
BRASS

### Male Flush Face Valve

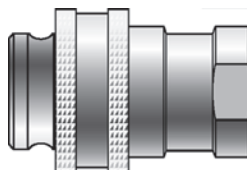

Part No.	Descr.	Prod. No.			
			"		
G95011-0604	6MQFFH-4FP	7252-88085	1/4-18	10000	20000
G95011-0606	6MQFFH-6FP	7252-88095	3/8-18	10000	20000
G95011-0808	8MQFFH-8FP	7252-88145	1/2-14	5000	10000
G95011-1212	12MQFFH-12FP	7252-88155	3/4-14	5000	10000
G95011-1616A	16MQFFH-16FPA*	7252-88325	1-11 1/2	5000	10000
G95011-1616	16MQFFH-16FP	7252-88165	1-11 1/2	5000	10000

\*This coupling features a higher working pressure and flatter face for minimization of fluid loss.

### Female Flush Face Valve

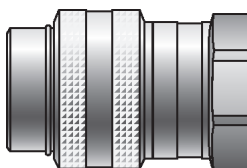

Part No.	Descr.	Prod. No.			
			"		
G95021-0604	6FQFFH-4FP	7252-88105	1/4-18	10000	20000
G95021-0606	6FQFFH-6FP	7252-88115	3/8-18	10000	20000
G95021-0808	8FQFFH-8FP	7252-88175	1/2-14	5000	10000
G95021-1212	12FQFFH-12FP	7252-88185	3/4-14	5000	10000
G95021-1616A	16FQFFH-16FPA*	7252-88335	1-11 1/2	5000	10000
G95021-1616	16FQFFH-16FP	7252-88195	1-11 1/2	5000	10000

\*This coupling features a higher working pressure and flatter face for minimization of fluid loss.

### QD Dust Plug



Part No.	Descr.	Prod. No.
G95080-0006	6QDFFHDP	7252-88125
G95080-0008	8QDFFHDP	7252-88205
G95080-0012	12QDFFHDP	7252-88215
G95080-0016	16QDFFHDP	7252-88225



# G950 SERIES (FLUSH FACE - HIGH PRESSURE)

## QD Dust Cap



Part No.	Descr.	Prod. No.
G95090-0006	6QDFFHDC	7252-88135
G95090-0008	8QDFFHDC	7252-88235
G95090-0012	12QDFFHDC	7252-88245
G95090-0016	16QDFFHDC	7252-88255

- EQUIPMENT
- HOSE/CPLG. SELECTION
- G8K COUPLINGS
- GLOBAL SPIRAL COUPLINGS
- STAINLESS STEEL SPIRAL
- MEGACRIMP COUPLINGS
- STAINLESS STEEL BRAID
- POWER CRIMP COUPLINGS
- FIELD ATTACHABLE G1 & G2 COUPLINGS
- FIELD ATTACHABLE C5 COUPLINGS
- C14 COUPLINGS
- GL COUPLINGS
- GLX COUPLINGS
- PCTS THERMOPLASTIC COUPLINGS
- POLARSEAL COUPLINGS (ACA)
- POLARSEAL II COUPLINGS (ACC)
- POLARSEAL II COUPLINGS (ACB)
- POWER STEERING
- ADAPTERS
- QUICK DISCONNECT COUPLERS
- BALL VALVES
- LIVE SWIVEL
- ASSEMBLY FABRICATION
- ACCESSORIES
- EQUIPMENT AND PARTS
- KITS
- AIR BRAKE HOSE ASSY
- BRASS



EQUIPMENT
HOSE/CPLG. SELECTION
G8K COUPLINGS
GLOBAL SPIRAL COUPLINGS
STAINLESS STEEL SPIRAL
MEGACRIMP COUPLINGS
STAINLESS STEEL BRAID
POWER CRIMP COUPLINGS
FIELD ATTACHABLE G1 & G2 COUPLINGS
FIELD ATTACHABLE C5 COUPLINGS
C14 COUPLINGS
GL COUPLINGS
GLX COUPLINGS
PCTS THERMOPLASTIC COUPLINGS
POLARSEAL COUPLINGS (ACA)
POLARSEAL II COUPLINGS (ACC)
POLARSEAL II COUPLINGS (ACB)
POWER STEERING
ADAPTERS
QUICK DISCONNECT COUPLERS
BALL VALVES
LIVE SWIVEL
ASSEMBLY FABRICATION
ACCESSORIES
EQUIPMENT AND PARTS
KITS
AIR BRAKE HOSE ASSY
BRASS

### Male (Brass) - Less Flange

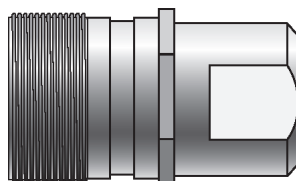

Part No.	Descr.	Prod. No.			
			"		
△ G95111-1212	12MQW-12FP	7252-88525	3/4-14	3000	9000
△ G95111-1616	16MQW-16FP	7252-88535	1-11 1/2	3000	9000
△ G95111-2020	20MQW-20FP	7252-88545	1 1/4-11 1/2	2750	8250
△ G95111-2424	24MQW-24FP	7252-88555	1 1/2-11 1/2	2500	7500

⚠ WARNING: Cancer and Reproductive Harm - www.P65Warnings.ca.gov

### Female (Brass) - Wing Nut (Cast Iron)

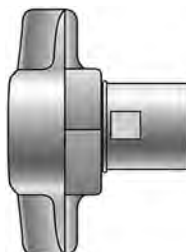

Part No.	Descr.	Prod. No.			
			"		
△ G95121-1212	12FQW-12FP	7252-88585	3/4-14	3000	9000
△ G95121-1616	16FQW-16FP	7252-88595	1-11 1/2	3000	9000
△ G95121-2020	20FQW-20FP	7252-88605	1 1/4-11 1/2	2750	8250
△ G95121-2424	24FQW-24FP	7252-88615	1 1/2-11 1/2	2500	7500

⚠ WARNING: Cancer and Reproductive Harm - www.P65Warnings.ca.gov

### Dust Plug



Part No.	Descr.	Prod. No.
G95180-0012	12QWDP	7252-88645
G95180-0016	16QWDP	7252-88655





### Dust Plug - Continued

Part No.	Descr.	Prod. No.
G95180-0020	20QWDP	7252-88665
G95180-0024	24QWDP	7252-88675

### Dust Cap



Part No.	Descr.	Prod. No.
G95190-0012	12QWDC	7252-88705
G95190-0016	16QWDC	7252-88715
G95190-0020	20QWDC	7252-88725
G95190-0024	24QWDC	7252-88735

- EQUIPMENT
- HOSE/CPLG. SELECTION
- G8K COUPLINGS
- GLOBAL SPIRAL COUPLINGS
- STAINLESS STEEL SPIRAL
- MEGACRIMP COUPLINGS
- STAINLESS STEEL BRAID
- POWER CRIMP COUPLINGS
- FIELD ATTACHABLE G1 & G2 COUPLINGS
- FIELD ATTACHABLE C5 COUPLINGS
- C14 COUPLINGS
- GL COUPLINGS
- GLX COUPLINGS
- PCTS THERMOPLASTIC COUPLINGS
- POLARSEAL COUPLINGS (ACA)
- POLARSEAL II COUPLINGS (ACC)
- POLARSEAL II COUPLINGS (ACB)
- POWER STEERING
- ADAPTERS
- QUICK DISCONNECT COUPLERS
- BALL VALVES
- LIVE SWIVEL
- ASSEMBLY FABRICATION
- ACCESSORIES
- EQUIPMENT AND PARTS
- KITS
- AIR BRAKE HOSE ASSY
- BRASS



EQUIPMENT
HOSE/CPLG. SELECTION
G8K COUPLINGS
GLOBAL SPIRAL COUPLINGS
STAINLESS STEEL SPIRAL
MEGACRIMP COUPLINGS
STAINLESS STEEL BRAID
POWER CRIMP COUPLINGS
FIELD ATTACHABLE G1 & G2 COUPLINGS
FIELD ATTACHABLE C5 COUPLINGS
C14 COUPLINGS
GL COUPLINGS
GLX COUPLINGS
PCTS THERMOPLASTIC COUPLINGS
POLARSEAL COUPLINGS (ACA)
POLARSEAL II COUPLINGS (ACC)
POLARSEAL II COUPLINGS (ACB)
POWER STEERING
ADAPTERS
QUICK DISCONNECT COUPLERS
BALL VALVES
LIVE SWIVEL
ASSEMBLY FABRICATION
ACCESSORIES
EQUIPMENT AND PARTS
KITS
AIR BRAKE HOSE ASSY
BRASS

### Male Acme Flat Threads to Female Pipe

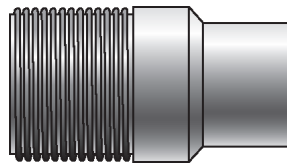

Part No.	Descr.	Prod. No.			
			"		
G95211-1212	12MQWH-12FP	7252-88745	3/4-14	5000	20000
G95211-1616	16MQWH-16FP	7252-88755	1-11 1/2	5000	20000
G95211-2020	20MQWH-20FP	7252-88765	1 1/4-11 1/2	5000	15000
G95211-2424	24MQWH-24FP	7252-88775	1 1/2-11 1/2	5000	15000
G95211-3232	32MQWH-32FP	7252-88785	2-11 1/2	5000	15000

### Female Wing Nut to Female Pipe

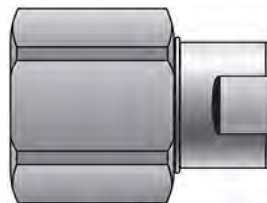

Part No.	Descr.	Prod. No.			
			"		
G95221-1212	12FQWH-12FP*	7252-88795	3/4-14	5000	20000
G95221-1616	16FQWH-16FP	7252-88805	1-11 1/2	5000	20000
G95221-2020	20FQWH-20FP	7252-88815	1 1/4-11 1/2	5000	15000
G95221-2424	24FQWH-24FP	7252-88825	1 1/2-11 1/2	5000	15000
G95221-3232	32FQWH-32FP	7252-88835	2-11 1/2	5000	15000

\*Features a hex nut on the coupler.

### Dust Plug



Part No.	Descr.	Prod. No.
G95280-0012	12QWHDP	7252-88845
G95280-0016	16QWHDP	7252-88855
G95280-0020	20QWHDP	7252-88865
G95280-0024	24QWHDP	7252-88875
G95280-0032	32QWHDP	7252-88885



### Dust Cap



Part No.	Descr.	Prod. No.
G95290-0012	12QWHDC	7252-88895
G95290-0016	16QWHDC	7252-88905
G95290-0020	20QWHDC	7252-88915
G95290-0024	24QWHDC	7252-88925
G95290-0032	32QWHDC	7252-88935

- EQUIPMENT
- HOSE/CPLG. SELECTION
- G8K COUPLINGS
- GLOBALSPIRAL COUPLINGS
- STAINLESS STEEL SPIRAL
- MEGACRIMP COUPLINGS
- STAINLESS STEEL BRAID
- POWER CRIMP COUPLINGS
- FIELD ATTACHABLE G1 & G2 COUPLINGS
- FIELD ATTACHABLE C5 COUPLINGS
- C14 COUPLINGS
- GL COUPLINGS
- GLX COUPLINGS
- PCTS THERMOPLASTIC COUPLINGS
- POLARSEAL COUPLINGS (ACA)
- POLARSEAL II COUPLINGS (ACC)
- POLARSEAL II COUPLINGS (ACB)
- POWER STEERING
- ADAPTERS
- QUICK DISCONNECT COUPLERS
- BALL VALVES
- LIVE SWIVEL
- ASSEMBLY FABRICATION
- ACCESSORIES
- EQUIPMENT AND PARTS
- KITS
- AIR BRAKE HOSE ASSY
- BRASS



EQUIPMENT
HOSE/CPLG. SELECTION
G8K COUPLINGS
GLOBAL SPIRAL COUPLINGS
STAINLESS STEEL SPIRAL
MEGACRIMP COUPLINGS
STAINLESS STEEL BRAID
POWER CRIMP COUPLINGS
FIELD ATTACHABLE G1 & G2 COUPLINGS
FIELD ATTACHABLE C5 COUPLINGS
C14 COUPLINGS
GL COUPLINGS
GLX COUPLINGS
PCTS THERMOPLASTIC COUPLINGS
POLARSEAL COUPLINGS (ACA)
POLARSEAL II COUPLINGS (ACC)
POLARSEAL II COUPLINGS (ACB)
POWER STEERING
ADAPTERS
QUICK DISCONNECT COUPLERS
BALL VALVES
LIVE SWIVEL
ASSEMBLY FABRICATION
ACCESSORIES
EQUIPMENT AND PARTS
KITS
AIR BRAKE HOSE ASSY
BRASS

## Male Poppet Valve to Female Pipe

Recommended for MobileCrimp® crimper-to-pump connection.

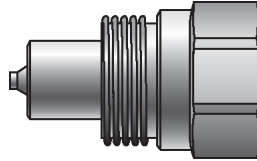

Part No.	Descr.	Prod. No.			
			"		
G95311-0606	6MQFFVH-6FP	7252-88315	3/8-18	14500	28000

## Female Screw to Connect to Female Pipe

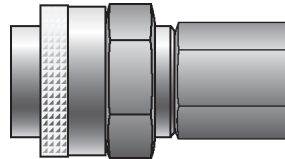

Part No.	Descr.	Prod. No.			
			"		
G95321-0606	6FQFFVH-6FP	7252-88305	3/8-18	14500	28000



### Male Poppet Valve to Female Pipe

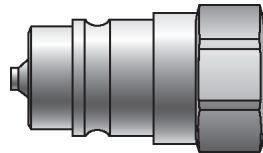

Part No.	Descr.	Prod. No.			
			"		
G95611-0404	4MQP-4FP	7252-89905	1/4-18	4600	18400
G95611-0606	6MQP-6FP	7252-89915	3/8-18	4600	18400
G95611-0808	8MQP-8FP	7252-89925	1/2-14	4000	16000
G95611-1212	12MQP-12FP	7252-89935	3/4-14	4000	16000
G95611-1616	16MQP-16FP	7252-89945	1-11 1/2	3000	12000

### Female Poppet Valve to Female Pipe

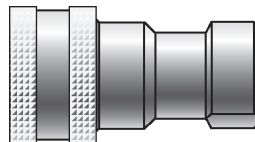

Part No.	Descr.	Prod. No.			
			"		
G95621-0404	4FQP-4FP	7252-89955	1/4-18	4600	18400
G95621-0606	6FQP-6FP	7252-89965	3/8-18	4600	18400
G95621-1212	12FQP-12FP	7252-89985	3/4-14	4000	16000
G95621-1616	16FQP-16FP	7252-89995	1-11 1/2	3000	12000

### O-Ring



Part No.	Descr.	Prod. No.
G95625-0004	4QDOR	7252-59955
G95625-0006	6QDOR	7252-59965
G95625-0008	8QDOR	7252-59975
G95625-0012	12QDOR	7252-59985
G95625-0016	16QDOR	7252-59995

EQUIPMENT
HOSE/CPLG. SELECTION
G8K COUPLINGS
GLOBALSPIRAL COUPLINGS
STAINLESS STEEL SPIRAL
MEGACRIMP COUPLINGS
STAINLESS STEEL BRAID
POWER CRIMP COUPLINGS
FIELD ATTACHABLE G1 & G2 COUPLINGS
FIELD ATTACHABLE C5 COUPLINGS
C14 COUPLINGS
GL COUPLINGS
GLX COUPLINGS
PCTS THERMOPLASTIC COUPLINGS
POLARSEAL COUPLINGS (ACA)
POLARSEAL II COUPLINGS (ACC)
POLARSEAL II COUPLINGS (ACB)
POWER STEERING
ADAPTERS
QUICK DISCONNECT COUPLERS
BALL VALVES
LIVE SWIVEL
ASSEMBLY FABRICATION
ACCESSORIES
EQUIPMENT AND PARTS
KITS
AIR BRAKE HOSE ASSY
BRASS



EQUIPMENT
HOSE/CPLG. SELECTION
G8K COUPLINGS
GLOBAL SPIRAL COUPLINGS
STAINLESS STEEL SPIRAL
MEGACRIMP COUPLINGS
STAINLESS STEEL BRAID
POWER CRIMP COUPLINGS
FIELD ATTACHABLE G1 & G2 COUPLINGS
FIELD ATTACHABLE C5 COUPLINGS
C14 COUPLINGS
GL COUPLINGS
GLX COUPLINGS
PCTS THERMOPLASTIC COUPLINGS
POLARSEAL COUPLINGS (ACA)
POLARSEAL II COUPLINGS (ACC)
POLARSEAL II COUPLINGS (ACB)
POWER STEERING
ADAPTERS
QUICK DISCONNECT COUPLERS
BALL VALVES
LIVE SWIVEL
ASSEMBLY FABRICATION
ACCESSORIES
EQUIPMENT AND PARTS
KITS
AIR BRAKE HOSE ASSY
BRASS

### Backup Ring



Part No.	Descr.	Prod. No.
G95626-0004	4QDBR	7252-49955
G95626-0006	6QDBR	7252-49965
G95626-0008	8QDBR	7252-49975
G95626-0012	12QDBR	7252-49985
G95626-0016	16QDBR	7252-49995

### QD Dust Plug



Part No.	Descr.	Prod. No.
G95680-0004	4QDDP	7252-89805
G95680-0006	6QDDP	7252-89815
G95680-0008	8QDDP	7252-89825
G95680-0012	12QDDP	7252-89835
G95680-0016	16QDDP	7252-89845

### QD Dust Cap



Part No.	Descr.	Prod. No.
G95690-0004	4QDDC	7252-89855
G95690-0006	6QDDC	7252-01395
G95690-0008	8QDDC	7252-89875
G95690-0012	12QDDC	7252-89885
G95690-0016	16QDDC	7252-89895



### John Deere Old Style to ISO Style

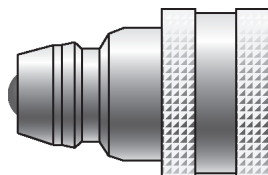

Part No.	Descr.	Prod. No.	
G95961-0808	8MJD-8FISO	7252-89615	3000

### ISO Style to John Deere Old Style

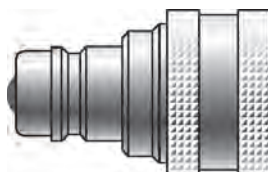

Part No.	Descr.	Prod. No.	
G95962-0808	8MISO-8FJD	7252-89625	3000

### Int'l Harvester to John Deere Old Style

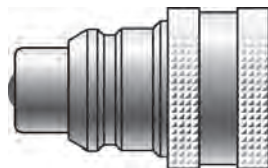

Part No.	Descr.	Prod. No.	
G95963-0808	8MIHC-8FJD	7252-89635	3000

### Int'l Harvester Old Style to ISO Style

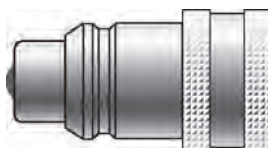

Part No.	Descr.	Prod. No.	
G95964-0808	8MIHC-8FISO	7252-89645	3000

- EQUIPMENT
- HOSE/CPLG. SELECTION
- G8K COUPLINGS
- GLOBAL SPIRAL COUPLINGS
- STAINLESS STEEL SPIRAL
- MEGACRIMP COUPLINGS
- STAINLESS STEEL BRAID
- POWER CRIMP COUPLINGS
- FIELD ATTACHABLE G1 & G2 COUPLINGS
- FIELD ATTACHABLE C5 COUPLINGS
- C14 COUPLINGS
- GL COUPLINGS
- GLX COUPLINGS
- PCTS THERMOPLASTIC COUPLINGS
- POLARSEAL COUPLINGS (ACA)
- POLARSEAL II COUPLINGS (ACC)
- POLARSEAL II COUPLINGS (ACB)
- POWER STEERING
- ADAPTERS
- QUICK DISCONNECT COUPLERS
- BALL VALVES
- LIVE SWIVEL
- ASSEMBLY FABRICATION
- ACCESSORIES
- EQUIPMENT AND PARTS
- KITS
- AIR BRAKE HOSE ASSY
- BRASS



EQUIPMENT
HOSE/CPLG. SELECTION
G8K COUPLINGS
GLOBAL SPIRAL COUPLINGS
STAINLESS STEEL SPIRAL
MEGACRIMP COUPLINGS
STAINLESS STEEL BRAID
POWER CRIMP COUPLINGS
FIELD ATTACHABLE G1 & G2 COUPLINGS
FIELD ATTACHABLE C5 COUPLINGS
C14 COUPLINGS
GL COUPLINGS
GLX COUPLINGS
PCTS THERMOPLASTIC COUPLINGS
POLARSEAL COUPLINGS (ACA)
POLARSEAL II COUPLINGS (ACC)
POLARSEAL II COUPLINGS (ACB)
POWER STEERING
ADAPTERS
QUICK DISCONNECT COUPLERS
BALL VALVES
LIVE SWIVEL
ASSEMBLY FABRICATION
ACCESSORIES
EQUIPMENT AND PARTS
KITS
AIR BRAKE HOSE ASSY
BRASS

### ISO Style to Int'l Harvester Old Style

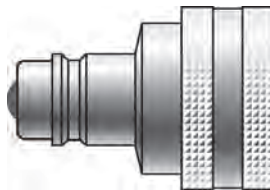

Part No.	Descr.	Prod. No.	
G95965-0808	8MISO-8FIHC	7252-89655	3000

### ISO Style to John Deere Old Style - (Double Shutoff)

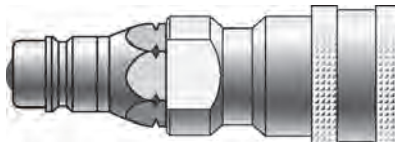

Part No.	Descr.	Prod. No.	
G95966-0808	8MISO-8FJDDSO	7252-89665	3000

### ISO Style to Int'l Harvester Old Style - (Double Shutoff)

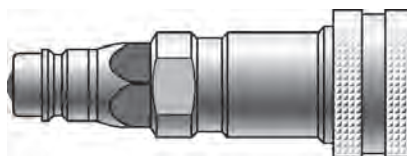

Part No.	Descr.	Prod. No.	
G95967-0808	8MISO-8FIHCDSO	7252-89675	3000





### Female Pipe NPTF

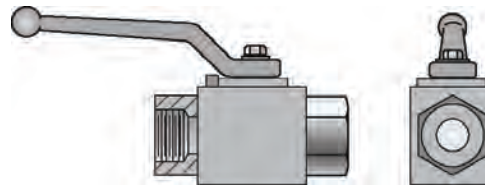

Part No.	Descr.	Prod. No.			
			"	"	
G96110-0404	4FP-4FPBV	7317-00015	1/4	1/4-18	7350
G96110-0606	6FP-6FPBV	7317-00025	3/8	3/8-18	7350
G96110-0808	8FP-8FPBV	7317-00035	1/2	1/2-14	7350
G96110-1212	12FP-12FPBV	7317-00045	3/4	3/4-14	5880
G96110-1616	16FP-16FPBV	7317-00055	1	1-11 1/2	5145
G96110-2016	20FP-16FPBV	7317-00065	1	1 1/4-11 1/2	5145

### Female O-Ring Boss

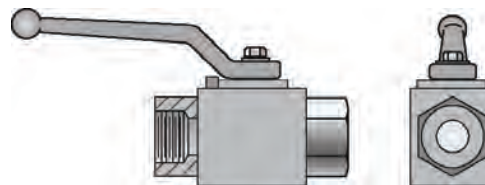

Part No.	Descr.	Prod. No.			
			"	"	
G96115-0404	4FB-4FBBV	7317-00075	1/4	7/16-20	7350
G96115-0606	6FB-6FBBV	7317-00085	3/8	9/16-18	7350
G96115-0808	8FB-8FBBV	7317-00095	1/2	3/4-16	7350
G96115-1212	12FB-12FBBV	7317-00105	3/4	1 1/16-12	5880
G96115-1616	16FB-16FBBV	7317-00115	1	1 5/16-12	5145

### Code 61 O-Ring Flange



Part No.	Descr.	Prod. No.		Nom. Flg. Size	
			"	"	
G96300-0808	8FL-8FLBV	7317-00215	1/2	1/2	3000
G96300-1212	12FL-12FLBV	7317-00225	3/4	3/4	3000
G96300-1616	16FL-16FLBV	7317-00235	1	1	3000
G96310-2020	20FL-20FLBV	7317-00245	1 1/4	1 1/4	3000

- EQUIPMENT
- HOSE/CPLG. SELECTION
- G8K COUPLINGS
- GLOBAL SPIRAL COUPLINGS
- STAINLESS STEEL SPIRAL
- MEGACRIMP COUPLINGS
- STAINLESS STEEL BRAID
- POWER CRIMP COUPLINGS
- FIELD ATTACHABLE G1 & G2 COUPLINGS
- FIELD ATTACHABLE C5 COUPLINGS
- C14 COUPLINGS
- GL COUPLINGS
- GLX COUPLINGS
- PCTS THERMOPLASTIC COUPLINGS
- POLARSEAL COUPLINGS (ACA)
- POLARSEAL II COUPLINGS (ACC)
- POLARSEAL II COUPLINGS (ACB)
- POWER STEERING
- ADAPTERS
- QUICK DISCONNECT COUPLERS
- BALL VALVES
- LIVE SWIVEL
- ASSEMBLY FABRICATION
- ACCESSORIES
- EQUIPMENT AND PARTS
- KITS
- AIR BRAKE HOSE ASSY
- BRASS

Code 61 O-Ring Flange - Continued

Part No.	Descr.	Prod. No.		Nom. Flg. Size	
			"	"	
G96310-2424	24FL-24FLBV	7317-00255	1 1/2	1 1/2	3000
G96310-3232	32FL-32FLBV	7317-00265	2	2	3000

Code 62 O-Ring Flange



Part No.	Descr.	Prod. No.		Nom. Flg. Size	
			"	"	
G96350-0808	8FLH-8FLHBV	7317-00275	1/2	1/2	6000
G96350-1212	12FLH-12FLHBV	7317-00285	3/4	3/4	6000
G96350-1616	16FLH-16FLHBV	7317-00295	1	1	6000
G96355-2020	20FLH-20FLHBV	7317-00305	1 1/4	1 1/4	6000
G96355-2424	24FLH-24FLHBV	7317-00315	1 1/2	1 1/2	6000
G96355-3232	32FLH-32FLHBV	7317-00325	2	2	6000

EQUIPMENT
HOSE/CPLG. SELECTION
G8K COUPLINGS
GLOBAL SPIRAL COUPLINGS
STAINLESS STEEL SPIRAL
MEGACRIMP COUPLINGS
STAINLESS STEEL BRAID
POWER CRIMP COUPLINGS
FIELD ATTACHABLE G1 & G2 COUPLINGS
FIELD ATTACHABLE C5 COUPLINGS
C14 COUPLINGS
GL COUPLINGS
GLX COUPLINGS
PCTS THERMOPLASTIC COUPLINGS
POLARSEAL COUPLINGS (ACA)
POLARSEAL II COUPLINGS (ACC)
POLARSEAL II COUPLINGS (ACB)
POWER STEERING
ADAPTERS
QUICK DISCONNECT COUPLERS
BALL VALVES
LIVE SWIVEL
ASSEMBLY FABRICATION
ACCESSORIES
EQUIPMENT AND PARTS
KITS
AIR BRAKE HOSE ASSY
BRASS



Female Pipe NPTF

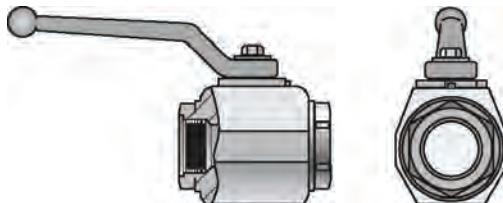

Part No.	Descr.	Prod. No.			
			"	"	
G96120-2020	20FP-20FPBV	7317-00125	1 1/4	1 1/4-11 1/2	6175
G96120-2424	24FP-24FPBV	7317-00135	1 1/2	1 1/2-11 1/2	6175
G96120-3232	32FP-32FPBV	7317-00145	2	2-11 1/2	6175

- EQUIPMENT
- HOSE/CPLG. SELECTION
- G8K COUPLINGS
- GLOBAL SPIRAL COUPLINGS
- STAINLESS STEEL SPIRAL
- MEGACRIMP COUPLINGS
- STAINLESS STEEL BRAID
- POWER CRIMP COUPLINGS
- FIELD ATTACHABLE G1 & G2 COUPLINGS
- FIELD ATTACHABLE C5 COUPLINGS
- C14 COUPLINGS
- GL COUPLINGS
- GLX COUPLINGS
- PCTS THERMOPLASTIC COUPLINGS
- POLARSEAL COUPLINGS (ACA)
- POLARSEAL II COUPLINGS (ACC)
- POLARSEAL II COUPLINGS (ACB)
- POWER STEERING
- ADAPTERS
- QUICK DISCONNECT COUPLERS
- BALL VALVES
- LIVE SWIVEL
- ASSEMBLY FABRICATION
- ACCESSORIES
- EQUIPMENT AND PARTS
- KITS
- AIR BRAKE HOSE ASSY
- BRASS



## Ball Valve Lock Out Kits

Part No.	Descr.	Prod. No.
G96050-0408	1/4" THRU 1/2" BV LOCK OUT KIT	7317-00335
G96050-1216	3/4" THRU 1" BV LOCK OUT KIT	7317-00345
G96050-2032	1 1/4" THRU 2" BV LOCK OUT KIT	7317-00355

## Female Pipe NPTF

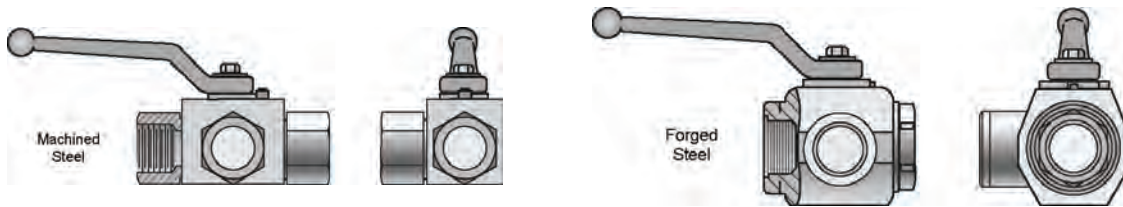



Part No.	Descr.	Prod. No.			
			"	"	
G96210-0404	4FP-4FP-4FPBV	7317-00155	1/4	1/4-18	5880
G96210-0606	6FP-6FP-6FPBV	7317-00165	3/8	3/8-18	5880
G96210-0808	8FP-8FP-8FPBV	7317-00175	1/2	1/2-14	5145
G96210-1212	12FP-12FP-12FPBV	7317-00185	3/4	3/4-14	5145
G96210-1616	16FP-16FP-16FPBV	7317-00195	1	1-11 1/2	5145
G96211-2020	20FP-20FP-20FPBV	7317-00205	1 1/4	1 1/4-11 1/2	5145

EQUIPMENT
HOSE/CPLG. SELECTION
G8K COUPLINGS
GLOBAL SPIRAL COUPLINGS
STAINLESS STEEL SPIRAL
MEGACRIMP COUPLINGS
STAINLESS STEEL BRAID
POWER CRIMP COUPLINGS
FIELD ATTACHABLE G1 & G2 COUPLINGS
FIELD ATTACHABLE C5 COUPLINGS
C14 COUPLINGS
GL COUPLINGS
GLX COUPLINGS
PCTS THERMOPLASTIC COUPLINGS
POLARSEAL COUPLINGS (ACA)
POLARSEAL II COUPLINGS (ACC)
POLARSEAL II COUPLINGS (ACB)
POWER STEERING
ADAPTERS
QUICK DISCONNECT COUPLERS
BALL VALVES
LIVE SWIVEL
ASSEMBLY FABRICATION
ACCESSORIES
EQUIPMENT AND PARTS
KITS
AIR BRAKE HOSE ASSY
BRASS



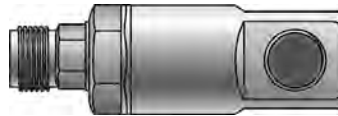

### Male Pipe to Female Pipe - 90°



Part No.	Descr.	Prod. No.		
			"	"
G93340-0606	6MP-6FP-LX90	7252-10175	3/8-18	3/8-18
G93340-0808	8MP-8FP-LX90	7252-10185	1/2-14	1/2-14
G93340-1212	12MP-12FP-LX90	7252-10195	3/4-14	3/4-14
G93340-1616	16MP-16FP-LX90	7252-10205	1-11 1/2	1-11 1/2

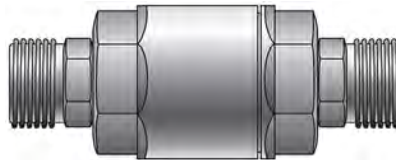

### Male BSPP to Male BSPP

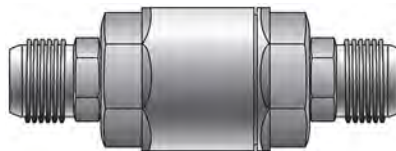

Part No.	Descr.	Prod. No.				Hex Shank	Hex Body	Overall Length	Diameter
				"	"				
G93345-0808	8BSPP-8BSPP-LX	7252-12415	6000	1/2-14	1/2-14	3/4	1 5/16	3.44	1.53
G93345-1212	12BSPP-12BSPP-LX	7252-12425	6000	3/4-14	3/4-14	15/16	1 5/8	4.52	2.00
G93345-1616	16BSPP-16BSPP-LX	7252-12435	6000	1-11	1-11	1 3/16	1 7/8	5.06	2.22

### Male JIC to Male JIC



Part No.	Descr.	Prod. No.				Hex Shank	Hex Body	Overall Length	Diameter
				"	"				
G93410-0606	6MJ-6MJ-LX	7252-12345	6000	9/16-18	9/16-18	1/2	1	2.91	1.25
G93410-0808	8MJ-8MJ-LX	7252-12355	6000	3/4-16	3/4-16	11/16	1 1/4	3.88	1.50
G93410-1212	12MJ-12MJ-LX	7252-12365	6000	1 1/16-12	1 1/16-12	15/16	1 5/8	4.94	2.00
G93410-1616	16MJ-16MJ-LX	7252-12375	6000	1 5/16-12	1 5/16-12	1 3/16	1 7/8	5.56	2.22
G93410-2020	20MJ-20MJ-LX	7252-12385	5500	1 5/8-12	1 5/8-12	1 1/2	2 3/8	6.06	2.75
G93410-2424	24MJ-24MJ-LX	7252-12395	4500	1 7/8-12	1 7/8-12	1 3/4	2 1/2	6.44	3.00
G93410-3232	32MJ-32MJ-LX	7252-12405	3000	2 1/2-12	2 1/2-12	2 5/16	3 1/4	7.69	3.88

EQUIPMENT
HOSE/CPLG. SELECTION
G8K COUPLINGS
GLOBALSPIRAL COUPLINGS
STAINLESS STEEL SPIRAL
MEGACRIMP COUPLINGS
STAINLESS STEEL BRAID
POWER CRIMP COUPLINGS
FIELD ATTACHABLE G1 & G2 COUPLINGS
FIELD ATTACHABLE C5 COUPLINGS
C14 COUPLINGS
GL COUPLINGS
GLX COUPLINGS
PCTS THERMOPLASTIC COUPLINGS
POLARSEAL COUPLINGS (ACA)
POLARSEAL II COUPLINGS (ACC)
POLARSEAL II COUPLINGS (ACB)
POWER STEERING
ADAPTERS
QUICK DISCONNECT COUPLERS
BALL VALVES
<b>LIVE SWIVEL</b>
ASSEMBLY FABRICATION
ACCESSORIES
EQUIPMENT AND PARTS
KITS
AIR BRAKE HOSE ASSY
BRASS



EQUIPMENT
HOSE/CPLG. SELECTION
G8K COUPLINGS
GLOBAL SPIRAL COUPLINGS
STAINLESS STEEL SPIRAL
MEGACRIMP COUPLINGS
STAINLESS STEEL BRAID
POWER CRIMP COUPLINGS
FIELD ATTACHABLE G1 & G2 COUPLINGS
FIELD ATTACHABLE C5 COUPLINGS
C14 COUPLINGS
GL COUPLINGS
GLX COUPLINGS
PCTS THERMOPLASTIC COUPLINGS
POLARSEAL COUPLINGS (ACA)
POLARSEAL II COUPLINGS (ACC)
POLARSEAL II COUPLINGS (ACB)
POWER STEERING
ADAPTERS
QUICK DISCONNECT COUPLERS
BALL VALVES
LIVE SWIVEL
ASSEMBLY FABRICATION
ACCESSORIES
EQUIPMENT AND PARTS
KITS
AIR BRAKE HOSE ASSY
BRASS

### Male JIC to Male JIC - 90°

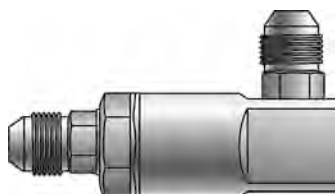

Part No.	Descr.	Prod. No.		
			"	"
G93420-0606	6MJ-6MJ-LX90S	7252-10095	9/16-18	9/16-18
G93415-0808	8MJ-8MJ-LX90	7252-10255	3/4-16	3/4-16
G93420-0808	8MJ-8MJ-LX90S	7252-10105	3/4-16	3/4-16
G93415-1212	12MJ-12MJ-LX90	7252-10265	1 1/16-12	1 1/16-12
G93420-1212	12MJ-12MJ-LX90S	7252-10115	1 1/16-12	1 1/16-12
G93415-1616	16MJ-16MJ-LX90	7252-10275	1 5/16-12	1 5/16-12
G93420-1616	16MJ-16MJ-LX90S	7252-10125	1 5/16-12	1 5/16-12
G93415-2020	20MJ-20MJ-LX90	7252-10285	1 5/8-12	1 5/8-12

### Male JIC to Female JIC/Boss

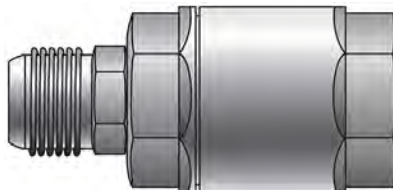

Part No.	Descr.	Prod. No.				Hex Shank	Hex Body	Overall Length	Diameter
				"	"				
G93450-0808	8MJ-8FJ/FB-LX	7252-12285	6000	3/4-16	3/4-16	11/16	1 1/4	3.31	1.50
G93450-1212	12MJ-12FJ/FB-LX	7252-12295	6000	1 1/16-12	1 1/16-12	15/16	1 5/8	4.12	2.00
G93450-1616	16MJ-16FJ/FB-LX	7252-12305	6000	1 5/16-12	1 5/16-12	1 3/16	1 7/8	4.63	2.22
G93450-2020	20MJ-20FJ/FB-LX	7252-12315	5500	1 5/8-12	1 5/8-12	1 1/2	2 3/8	5.12	2.75
G93450-2424	24MJ-24FJ/FB-LX	7252-12325	4500	1 7/8-12	1 7/8-12	1 3/4	2 1/2	5.34	3.00
G93450-3232	32MJ-32FJ/FB-LX	7252-12335	3000	2 1/2-12	2 1/2-12	2 5/16	3 1/4	6.50	3.88

### Male JIC to Female Boss - 90°

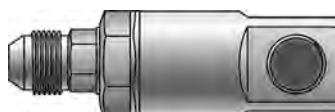

Part No.	Descr.	Prod. No.		
			"	"
G93455-0808	8MJ-8FB-LX90	7252-10215	3/4-16	3/4-16
G93455-1212	12MJ-12FB-LX90	7252-10225	1 1/16-12	1 1/16-12
G93455-1616	16MJ-16FB-LX90	7252-10235	1 5/16-12	1 5/16-12



Male JIC to Female Boss - 90° - Continued

Part No.	Descr.	Prod. No.		
			"	"
G93455-2020	20MJ-20FB-LX90	7252-10245	1 5/8-12	1 5/8-12

Male Boss to Female JIC/Boss - 90°

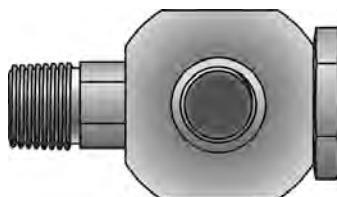



Part No.	Descr.	Prod. No.		
			"	"
G93460-0606	6MB-6FJ/FB-LX90S	7252-10015	9/16-18	9/16-18
G93460-0808	8MB-8FJ/FB-LX90S	7252-10025	3/4-16	3/4-16
G93460-1212	12MB-12FJ/FB-LX90S	7252-10035	1 1/16-12	1 1/16-12
G93460-1616	16MB-16FJ/FB-LX90S	7252-10045	1 5/16-12	1 5/16-12

JIC Seal Kit

Part No.	Descr.	Prod. No.	Standard Pack
G93500-0006	6JIC SWIVEL SEAL KIT	7252-12155	1
G93500-0008	8JIC SWIVEL SEAL KIT	7252-12165	1
G93500-0012	12JIC SWIVEL SEAL KIT	7252-12175	1
G93500-0016	16JIC SWIVEL SEAL KIT	7252-12185	1
G93500-0020	20JIC SWIVEL SEAL KIT	7252-12195	1
G93500-0024	24JIC SWIVEL SEAL KIT	7252-12205	1
G93500-0032	32JIC SWIVEL SEAL KIT	7252-12215	1

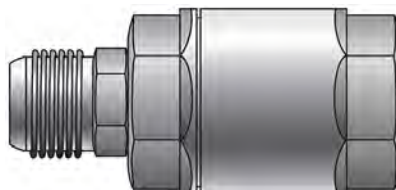
Male JIC to Female Pipe



Part No.	Descr.	Prod. No.				Hex Shank	Hex Body	Overall Length	Diameter
				"	"				
G93510-0808	8MJ-8FP-LX	7252-12255	6000	3/4-16	1/2-14	11/16	1 1/4	3.31	1.50
G93510-1212	12MJ-12FP-LX	7252-12265	6000	1 1/16-12	3/4-14	15/16	1 5/8	4.19	2.00
G93510-1616	16MJ-16FP-LX	7252-12275	6000	1 5/16-12	1-11 1/2	1 3/16	1 7/8	4.88	2.22

EQUIPMENT
HOSE/CPLG. SELECTION
G8K COUPLINGS
GLOBAL SPIRAL COUPLINGS
STAINLESS STEEL SPIRAL
MEGACRIMP COUPLINGS
STAINLESS STEEL BRAID
POWER CRIMP COUPLINGS
FIELD ATTACHABLE G1 & G2 COUPLINGS
FIELD ATTACHABLE C5 COUPLINGS
C14 COUPLINGS
GL COUPLINGS
GLX COUPLINGS
PCTS THERMOPLASTIC COUPLINGS
POLARSEAL COUPLINGS (ACA)
POLARSEAL II COUPLINGS (ACC)
POLARSEAL II COUPLINGS (ACB)
POWER STEERING
ADAPTERS
QUICK DISCONNECT COUPLERS
BALL VALVES
<b>LIVE SWIVEL</b>
ASSEMBLY FABRICATION
ACCESSORIES
EQUIPMENT AND PARTS
KITS
AIR BRAKE HOSE ASSY
BRASS



EQUIPMENT
HOSE/CPLG. SELECTION
G8K COUPLINGS
GLOBAL SPIRAL COUPLINGS
STAINLESS STEEL SPIRAL
MEGACRIMP COUPLINGS
STAINLESS STEEL BRAID
POWER CRIMP COUPLINGS
FIELD ATTACHABLE G1 & G2 COUPLINGS
FIELD ATTACHABLE C5 COUPLINGS
C14 COUPLINGS
GL COUPLINGS
GLX COUPLINGS
PCTS THERMOPLASTIC COUPLINGS
POLARSEAL COUPLINGS (ACA)
POLARSEAL II COUPLINGS (ACC)
POLARSEAL II COUPLINGS (ACB)
POWER STEERING
ADAPTERS
QUICK DISCONNECT COUPLERS
BALL VALVES
LIVE SWIVEL
ASSEMBLY FABRICATION
ACCESSORIES
EQUIPMENT AND PARTS
KITS
AIR BRAKE HOSE ASSY
BRASS

### Male Boss to Female Pipe - 90°



Part No.	Descr.	Prod. No.		
			"	"
G93520-0606	6MB-6FP-LX90S	7252-10135	9/16-18	3/8-18
G93520-0808	8MB-8FP-LX90S	7252-10145	3/4-16	1/2-14
G93520-1212	12MB-12FP-LX90S	7252-10155	1 1/16-12	3/4-14
G93520-1616	16MB-16FP-LX90S	7252-10165	1 5/16-12	1-11 1/2

### Male Boss to Male JIC - 90°

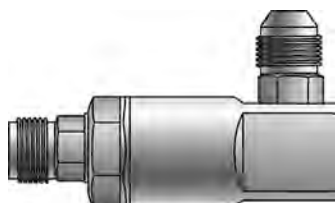

Part No.	Descr.	Prod. No.		
			"	"
G93530-0606	6MB-6MJ-LX90S	7252-10055	9/16-18	9/16-18
G93530-0808	8MB-8MJ-LX90S	7252-10065	3/4-16	3/4-16
G93530-1212	12MB-12MJ-LX90S	7252-10075	1 1/16-12	1 1/16-12
G93530-1616	16MB-16MJ-LX90S	7252-10085	1 5/16-12	1 5/16-12

### ORS Seal Kit

Part No.	Descr.	Prod. No.	Standard Pack
G93600-0012	12ORS LIVE SWIVEL SEAL KIT	7252-12235	1
G93600-0016	16ORS LIVE SWIVEL SEAL KIT	7252-12245	1

### ORS/BSPP Seal Kit

Part No.	Descr.	Prod. No.	Standard Pack
G93700-0008	8ORS/8BSPP LIVE SWVL SEAL KIT	7252-12225	1





### Male ORFS to Female ORFS

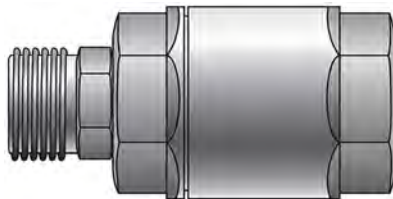

Part No.	Descr.	Prod. No.	⌚	🌀		Hex Shank	Hex Body	Overall Length	Diameter
				"	"				
G93724-1212	12MFFOR-12FFORX-LX	7252-12445	6000	1 3/16-12	1 3/16-12	1 1/16	1 3/4	3.86	2.09
G93724-1616	16MFFOR-16FFORX-LX	7252-12455	6000	1 7/16-12	1 7/16-12	1 5/16	2	4.38	2.31

### Male ORFS to Male ORFS

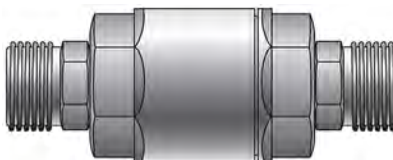

Part No.	Descr.	Prod. No.	⌚	🌀		Hex Shank	Hex Body	Overall Length	Diameter
				"	"				
G93742-0808	8MFFOR-8MFFOR-LX	7252-12465	6000	13/16-16	13/16-16	3/4	15/16	3.50	1.53
G93742-1212	12MFFOR-12MFFOR-LX	7252-12475	6000	1 3/16-12	1 3/16-12	1 1/16	1 3/4	4.52	2.09
G93742-1616	16MFFOR-16MFFOR-LX	7252-12485	6000	1 7/16-12	1 7/16-12	1 5/16	2	5.12	2.31

EQUIPMENT
HOSE/CPLG. SELECTION
G8K COUPLINGS
GLOBALSPIRAL COUPLINGS
STAINLESS STEEL SPIRAL
MEGACRIMP COUPLINGS
STAINLESS STEEL BRAID
POWER CRIMP COUPLINGS
FIELD ATTACHABLE G1 & G2 COUPLINGS
FIELD ATTACHABLE C5 COUPLINGS
C14 COUPLINGS
GL COUPLINGS
GLX COUPLINGS
PCTS THERMOPLASTIC COUPLINGS
POLARSEAL COUPLINGS (ACA)
POLARSEAL II COUPLINGS (ACC)
POLARSEAL II COUPLINGS (ACB)
POWER STEERING
ADAPTERS
QUICK DISCONNECT COUPLERS
BALL VALVES
LIVE SWIVEL
ASSEMBLY FABRICATION
ACCESSORIES
EQUIPMENT AND PARTS
KITS
AIR BRAKE HOSE ASSY
BRASS



**NOTES**

EQUIPMENT
HOSE/CPLG. SELECTION
G8K COUPLINGS
GLOBAL SPIRAL COUPLINGS
STAINLESS STEEL SPIRAL
MEGACRIMP COUPLINGS
STAINLESS STEEL BRAID
POWER CRIMP COUPLINGS
FIELD ATTACHABLE G1 & G2 COUPLINGS
FIELD ATTACHABLE C5 COUPLINGS
C14 COUPLINGS
GL COUPLINGS
GLX COUPLINGS
PCTS THERMOPLASTIC COUPLINGS
POLARSEAL COUPLINGS (ACA)
POLARSEAL II COUPLINGS (ACC)
POLARSEAL II COUPLINGS (ACB)
POWER STEERING
ADAPTERS
QUICK DISCONNECT COUPLERS
BALL VALVES
<b>LIVE SWIVEL</b>
ASSEMBLY FABRICATION
ACCESSORIES
EQUIPMENT AND PARTS
KITS
AIR BRAKE HOSE ASSY
BRASS



### Tube Assembly Equipment



Part No.	Prod. No.	Descr.	Standard Pack
91025	7468-1040	Bend-N-Fit Tube Bender	1

### Steel Power Steering & Transmission Oil Cooler Tubing - Male O-Ring



Part No.	Prod. No.	Descr.	Standard Pack
A35001-2405	7821-0113	24" - 5/16" Male O-Ring	2
A35001-2406	7821-0118	24" - 3/8" Male O-Ring	2
A35001-2407	7821-0126	24" - 7/16" Male O-Ring	2
A35001-2414	7821-0104	24" - 14mm Male O-Ring	2
A35001-2416	7821-0110	24" - 16mm Male O-Ring	2

### Steel Power Steering & Transmission Oil Cooler Tubing - Male Inverted Flare



Part No.	Prod. No.	Descr.	Standard Pack
A35003-2406	7821-0117	24" - 3/8" Inverted Male Flare	2
A35003-2414	7821-0103	24" - 14mm Male Inverted Flare	2
A35003-2416	7821-0109	24" - 16mm Male Inverted Flare	2

- EQUIPMENT
- HOSE/CPLG. SELECTION
- G8K COUPLINGS
- GLOBALSPIRAL COUPLINGS
- STAINLESS STEEL SPIRAL
- MEGACRIMP COUPLINGS
- STAINLESS STEEL BRAID
- POWER CRIMP COUPLINGS
- FIELD ATTACHABLE G1 & G2 COUPLINGS
- FIELD ATTACHABLE C5 COUPLINGS
- C14 COUPLINGS
- GL COUPLINGS
- GLX COUPLINGS
- PCTS THERMOPLASTIC COUPLINGS
- POLARSEAL COUPLINGS (ACA)
- POLARSEAL II COUPLINGS (ACC)
- POLARSEAL II COUPLINGS (ACB)
- POWER STEERING
- ADAPTERS
- QUICK DISCONNECT COUPLERS
- BALL VALVES
- LIVE SWIVEL
- ASSEMBLY FABRICATION
- ACCESSORIES
- EQUIPMENT AND PARTS
- KITS
- AIR BRAKE HOSE ASSY
- BRASS



EQUIPMENT
HOSE/CPLG. SELECTION
G8K COUPLINGS
GLOBAL SPIRAL COUPLINGS
STAINLESS STEEL SPIRAL
MEGACRIMP COUPLINGS
STAINLESS STEEL BRAID
POWER CRIMP COUPLINGS
FIELD ATTACHABLE G1 & G2 COUPLINGS
FIELD ATTACHABLE C5 COUPLINGS
C14 COUPLINGS
GL COUPLINGS
GLX COUPLINGS
PCTS THERMOPLASTIC COUPLINGS
POLARSEAL COUPLINGS (ACA)
POLARSEAL II COUPLINGS (ACC)
POLARSEAL II COUPLINGS (ACB)
POWER STEERING
ADAPTERS
QUICK DISCONNECT COUPLERS
BALL VALVES
LIVE SWIVEL
ASSEMBLY FABRICATION
ACCESSORIES
EQUIPMENT AND PARTS
KITS
AIR BRAKE HOSE ASSY
BRASS

## Steel Power Steering & Transmission Oil Cooler Tubing - Male SAE



Part No.	Prod. No.	Descr.	Standard Pack
A35004-2406	7821-0119	24" - 3/8" Male SAE	2

## Steel Power Steering & Transmission Oil Cooler Tubing - Long Swivel O-Ring



Part No.	Prod. No.	Descr.	Standard Pack
A35005-2416	7821-0108	24" - 16mm Long Swivel O-Ring	2

## Steel Power Steering & Transmission Oil Cooler Tubing - Swivel O-Ring Type I



Part No.	Prod. No.	Descr.	Standard Pack
A35006-2406	7821-0120	24" - 3/8" Swivel O-Ring Type I	2

## Steel Power Steering & Transmission Oil Cooler Tubing - Swivel O-Ring Type II



Part No.	Prod. No.	Descr.	Standard Pack
△ A35007-2405	7821-0114	24" - 5/16" Swivel O-Ring Type II	2

△ WARNING: Cancer and Reproductive Harm - www.P65Warnings.ca.gov



### Steel Power Steering & Transmission Oil Cooler Tubing - Swivel O-Ring Type III



Part No.	Prod. No.	Descr.	Standard Pack
A35008-2416	7821-0111	24" - 16mm Swivel O-Ring Type III	2

### Steel Power Steering & Transmission Oil Cooler Tubing - Male Captive O-Ring



Part No.	Prod. No.	Descr.	Standard Pack
A35010-2412	7821-0101	24" - 12mm Male Captive O-Ring	2

### Steel Power Steering & Transmission Oil Cooler Tubing - Captive O-Ring



Part No.	Prod. No.	Descr.	Standard Pack
A35011-2418	7821-0112	24" - 18mm Captive O-Ring	2

EQUIPMENT
HOSE/CPLG. SELECTION
G8K COUPLINGS
GLOBALSPIRAL COUPLINGS
STAINLESS STEEL SPIRAL
MEGACRIMP COUPLINGS
STAINLESS STEEL BRAID
POWER CRIMP COUPLINGS
FIELD ATTACHABLE G1 & G2 COUPLINGS
FIELD ATTACHABLE C5 COUPLINGS
C14 COUPLINGS
GL COUPLINGS
GLX COUPLINGS
PCTS THERMOPLASTIC COUPLINGS
POLARSEAL COUPLINGS (ACA)
POLARSEAL II COUPLINGS (ACC)
POLARSEAL II COUPLINGS (ACB)
POWER STEERING
ADAPTERS
QUICK DISCONNECT COUPLERS
BALL VALVES
LIVE SWIVEL
<b>ASSEMBLY FABRICATION</b>
ACCESSORIES
EQUIPMENT AND PARTS
KITS
AIR BRAKE HOSE ASSY
BRASS



EQUIPMENT
HOSE/CPLG. SELECTION
G8K COUPLINGS
GLOBAL SPIRAL COUPLINGS
STAINLESS STEEL SPIRAL
MEGACRIMP COUPLINGS
STAINLESS STEEL BRAID
POWER CRIMP COUPLINGS
FIELD ATTACHABLE G1 & G2 COUPLINGS
FIELD ATTACHABLE C5 COUPLINGS
C14 COUPLINGS
GL COUPLINGS
GLX COUPLINGS
PCTS THERMOPLASTIC COUPLINGS
POLARSEAL COUPLINGS (ACA)
POLARSEAL II COUPLINGS (ACC)
POLARSEAL II COUPLINGS (ACB)
POWER STEERING
ADAPTERS
QUICK DISCONNECT COUPLERS
BALL VALVES
LIVE SWIVEL
ASSEMBLY FABRICATION
ACCESSORIES
EQUIPMENT AND PARTS
KITS
AIR BRAKE HOSE ASSY
BRASS

## Steel Power Steering & Transmission Oil Cooler Tubing - Female SAE



Part No.	Prod. No.	Descr.	Standard Pack
A35012-2406	7821-0116	24" - 3/8" Female SAE	2
A35012-2408	7821-0127	24" - 1/2" Female SAE	2
A35012-2416	7821-0107	24" - 16mm Female SAE	2

## Steel Power Steering & Transmission Oil Cooler Tubing - Beaded Tube



Part No.	Prod. No.	Descr.	Standard Pack
A35020-2406	7821-0115	24" - 3/8" Beaded Tube	2

## Steel Power Steering & Transmission Oil Cooler Tubing - Male Single Bead Quick Connect



Part No.	Prod. No.	Descr.	Standard Pack
A35023-2406	7821-0124	24" - 3/8" Male Single Bead Quick Connect	2

## Steel Power Steering & Transmission Oil Cooler Tubing - Double Beaded Pipe



Part No.	Prod. No.	Descr.	Standard Pack
A35025-2406	7821-0121	24" - 3/8" Double Beaded Pipe	2



### Steel Power Steering & Transmission Oil Cooler Tubing - GM Quick Connect



Part No.	Prod. No.	Descr.	Standard Pack
A35030-2406	7821-0123	24" - 3/8" GM Quick Connect	2

### Aluminum Air Conditioning Tubing - Male Tube O-Ring



Part No.	Prod. No.	Descr.	Standard Pack
A45001-2406	7821-2024	24" - 3/8" Male Tube O-Ring	2
A45001-2408	7821-2025	24" - 1/2" Male Tube O-Ring	2

### Aluminum Air Conditioning Tubing - Male SAE



Part No.	Prod. No.	Descr.	Standard Pack
A45004-2406	7821-2020	24" - 3/8" Male SAE	2
A45004-2408	7821-2021	24" - 1/2" Male SAE	2

### Aluminum Air Conditioning Tubing - Male Inverted O-Ring



Part No.	Prod. No.	Descr.	Standard Pack
A45009-2406	7821-2029	24" - 3/8" Male Inverted O-Ring	2
A45009-2408	7821-2030	24" - 1/2" Male Inverted O-Ring	2

EQUIPMENT
HOSE/CPLG. SELECTION
G8K COUPLINGS
GLOBAL SPIRAL COUPLINGS
STAINLESS STEEL SPIRAL
MEGACRIMP COUPLINGS
STAINLESS STEEL BRAID
POWER CRIMP COUPLINGS
FIELD ATTACHABLE G1 & G2 COUPLINGS
FIELD ATTACHABLE C5 COUPLINGS
C14 COUPLINGS
GL COUPLINGS
GLX COUPLINGS
PCTS THERMOPLASTIC COUPLINGS
POLARSEAL COUPLINGS (ACA)
POLARSEAL II COUPLINGS (ACC)
POLARSEAL II COUPLINGS (ACB)
POWER STEERING
ADAPTERS
QUICK DISCONNECT COUPLERS
BALL VALVES
LIVE SWIVEL
ASSEMBLY FABRICATION
ACCESSORIES
EQUIPMENT AND PARTS
KITS
AIR BRAKE HOSE ASSY
BRASS



EQUIPMENT
HOSE/CPLG. SELECTION
G8K COUPLINGS
GLOBAL SPIRAL COUPLINGS
STAINLESS STEEL SPIRAL
MEGACRIMP COUPLINGS
STAINLESS STEEL BRAID
POWER CRIMP COUPLINGS
FIELD ATTACHABLE G1 & G2 COUPLINGS
FIELD ATTACHABLE C5 COUPLINGS
C14 COUPLINGS
GL COUPLINGS
GLX COUPLINGS
PCTS THERMOPLASTIC COUPLINGS
POLARSEAL COUPLINGS (ACA)
POLARSEAL II COUPLINGS (ACC)
POLARSEAL II COUPLINGS (ACB)
POWER STEERING
ADAPTERS
QUICK DISCONNECT COUPLERS
BALL VALVES
LIVE SWIVEL
ASSEMBLY FABRICATION
ACCESSORIES
EQUIPMENT AND PARTS
KITS
AIR BRAKE HOSE ASSY
BRASS

## Aluminum Air Conditioning Tubing - Female Tube O-Ring



Part No.	Prod. No.	Descr.	Standard Pack
A45011-2406	7821-2022	24" - 3/8" Female Tube O-Ring	2
A45011-2408	7821-2023	24" - 1/2" Female Tube O-Ring	2
A45011-2416	7821-2026	24" - 16mm Female Tube O-Ring	2
A45011-2418	7821-2027	24" - 18mm Female Tube O-Ring	2
A45011-2420	7821-2028	24" - 20mm Female Tube O-Ring	2

## Aluminum Air Conditioning Tubing - Female SAE



Part No.	Prod. No.	Descr.	Standard Pack
A45012-2406	7821-2018	24" - 3/8" Female SAE	2
A45012-2408	7821-2019	24" - 1/2" Female SAE	2

## Aluminum Air Conditioning Tubing - Male Ford Spring Lock



Part No.	Prod. No.	Descr.	Standard Pack
△ A45035-2406	7821-2031	24" - 3/8" Male Ford Spring Lock	2
△ A45035-2408	7821-2032	24" - 1/2" Male Ford Spring Lock	2

△ WARNING: Cancer and Reproductive Harm - www.P65Warnings.ca.gov





# Aluminum Air Conditioning Tubing - Female Ford Spring Lock



Part No.	Prod. No.	Descr.	Standard Pack
A45036-2406	7821-2033	24" - 3/8" Female Ford Spring Lock	2
A45036-2408	7821-2034	24" - 1/2" Female Ford Spring Lock	2

- EQUIPMENT
- HOSE/CPLG. SELECTION
- G8K COUPLINGS
- GLOBALSPIRAL COUPLINGS
- STAINLESS STEEL SPIRAL
- MEGACRIMP COUPLINGS
- STAINLESS STEEL BRAID
- POWER CRIMP COUPLINGS
- FIELD ATTACHABLE G1 & G2 COUPLINGS
- FIELD ATTACHABLE C5 COUPLINGS
- C14 COUPLINGS
- GL COUPLINGS
- GLX COUPLINGS
- PCTS THERMOPLASTIC COUPLINGS
- POLARSEAL COUPLINGS (ACA)
- POLARSEAL II COUPLINGS (ACC)
- POLARSEAL II COUPLINGS (ACB)
- POWER STEERING
- ADAPTERS
- QUICK DISCONNECT COUPLERS
- BALL VALVES
- LIVE SWIVEL
- ASSEMBLY FABRICATION**
- ACCESSORIES
- EQUIPMENT AND PARTS
- KITS
- AIR BRAKE HOSE ASSY
- BRASS



**NOTES**

EQUIPMENT
HOSE/CPLG. SELECTION
G8K COUPLINGS
GLOBAL SPIRAL COUPLINGS
STAINLESS STEEL SPIRAL
MEGACRIMP COUPLINGS
STAINLESS STEEL BRAID
POWER CRIMP COUPLINGS
FIELD ATTACHABLE G1 & G2 COUPLINGS
FIELD ATTACHABLE C5 COUPLINGS
C14 COUPLINGS
GL COUPLINGS
GLX COUPLINGS
PCTS THERMOPLASTIC COUPLINGS
POLARSEAL COUPLINGS (ACA)
POLARSEAL II COUPLINGS (ACC)
POLARSEAL II COUPLINGS (ACB)
POWER STEERING
ADAPTERS
QUICK DISCONNECT COUPLERS
BALL VALVES
LIVE SWIVEL
<b>ASSEMBLY FABRICATION</b>
ACCESSORIES
EQUIPMENT AND PARTS
KITS
AIR BRAKE HOSE ASSY
BRASS



## LifeGuard® Tools

Part No.	Prod. No.	Descr.	Standard Pack
78075	7484-1600	LifeGuard Sleeve Guide Table	1
78076	7482-1604	LifeGuard Sleeve Bullets -4, -6, -8	1

## LifeGuard® 3000, 4000 and 5000



Determining the Size of a Sleeve  
 $B = \text{Nominal I.D.} = "A" \times 2 + 3.14$

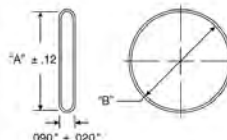

Part No.	Descr.	Prod. No.	A Inside Flat	B Sleeve I.D.	Standard Pack
			"	"	
G81102-0014	14LG3K	7277-1850	1.11	.71	120
G81102-0016	16LG3K	7277-1851	1.42	.91	120
G81102-0020	20LG3K	7277-1852	1.67	1.06	120
G81102-0022	22LG3K	7277-1853	2.13	1.35	120
G81102-0026	26LG3K	7277-1854	2.36	1.50	120
G81102-0032	32LG3K	7277-1855	2.78	1.99	120
G81104-0014	14LG4K	7277-1960	1.38	.88	120
G81104-0016	16LG4K	7277-1961	1.62	1.03	120
G81104-0020	20LG4K	7277-1962	1.91	1.22	120
G81104-0022	22LG4K	7277-1963	1.98	1.26	120
G81104-0026	26LG4K	7277-1964	2.50	1.59	120
G81104-0032	32LG4K	7277-1965	2.78	1.99	120
G81105-0014	14LG5K	7277-1950	1.38	.88	120
G81105-0016	16LG5K	7277-1951	1.62	1.03	120
G81105-0020	20LG5K	7277-1952	1.91	1.22	120
G81105-0022	22LG5K	7277-1953	2.13	1.35	120
G81105-0026	26LG5K	7277-1954	2.50	1.59	120

## LifeGuard® Clamp Collars - Stainless Steel



Part No.	Descr.	Prod. No.	⊖	Standard Pack
			"	
G81995-0406S	6SC-4-SS	7334-48535	1.15	1
G81995-0408S	8SC-4-SS	7334-48545	1.40	1
G81995-0410S	10SC-4-SS	7334-48605	1.62	1
G81995-0412S	12SC-4-SS	7334-48615	1.87	1
G81995-0516S	16SC-5-SS	7334-48815	2.09	1

- EQUIPMENT
- HOSE/CPLG. SELECTION
- G8K COUPLINGS
- GLOBALSPIRAL COUPLINGS
- STAINLESS STEEL SPIRAL
- MEGACRIMP COUPLINGS
- STAINLESS STEEL BRAID
- POWER CRIMP COUPLINGS
- FIELD ATTACHABLE G1 & G2 COUPLINGS
- FIELD ATTACHABLE C5 COUPLINGS
- C14 COUPLINGS
- GL COUPLINGS
- GLX COUPLINGS
- PCTS THERMOPLASTIC COUPLINGS
- POLARSEAL COUPLINGS (ACA)
- POLARSEAL II COUPLINGS (ACC)
- POLARSEAL II COUPLINGS (ACB)
- POWER STEERING
- ADAPTERS
- QUICK DISCONNECT COUPLERS
- BALL VALVES
- LIVE SWIVEL
- ASSEMBLY FABRICATION
- ACCESSORIES
- EQUIPMENT AND PARTS
- KITS
- AIR BRAKE HOSE ASSY
- BRASS



## Clamp Collar for Nylon Sleeve and LifeGuard® Sleeve



EQUIPMENT
HOSE/CPLG. SELECTION
G8K COUPLINGS
GLOBAL SPIRAL COUPLINGS
STAINLESS STEEL SPIRAL
MEGACRIMP COUPLINGS
STAINLESS STEEL BRAID
POWER CRIMP COUPLINGS
FIELD ATTACHABLE G1 & G2 COUPLINGS
FIELD ATTACHABLE C5 COUPLINGS
C14 COUPLINGS
GL COUPLINGS
GLX COUPLINGS
PCTS THERMOPLASTIC COUPLINGS
POLARSEAL COUPLINGS (ACA)
POLARSEAL II COUPLINGS (ACC)
POLARSEAL II COUPLINGS (ACB)
POWER STEERING
ADAPTERS
QUICK DISCONNECT COUPLERS
BALL VALVES
LIVE SWIVEL
ASSEMBLY FABRICATION
ACCESSORIES
EQUIPMENT AND PARTS
KITS
AIR BRAKE HOSE ASSY
BRASS

Part No.	Descr.	Prod. No.	⌀	Standard Pack
			"	
G81995-0104	4SC-1	7334-60035	.86	1
G81995-0104X	4SC-1 XBULK	7334-6003	.86	1300
G81995-0106	6SC-1	7334-60125	1.00	1
G81995-0106X	6SC-1 XBULK	7334-6012	1.00	2000
G81995-0108	8SC-1	7334-60315	1.18	1
G81995-0108X	8SC-1 XBULK	7334-6031	1.18	2000
G81995-0110	10SC-1	7334-60545	1.40	1
G81995-0110X	10SC-1 XBULK	7334-6054	1.40	250
G81995-0112	12SC-1	7334-60755	1.62	1
G81995-0112X	12SC-1 XBULK	7334-6075	1.62	1000
G81995-0116X	16SC-2 XBULK	7334-4882	2.06	150
G81995-0204X	4SC-2 XBULK	7334-6001	.81	900
G81995-0210	10SC-2	7334-60515	1.26	1
G81995-0210X	10SC-2 XBULK	7334-6051	1.26	100000
G81995-0212	12SC-2	7334-60715	1.45	1
G81995-0212X	12SC-2 XBULK	7334-6071	1.45	1250
G81995-0306	6SC-3	7334-60145	1.05	1
G81995-0306X	6SC-3 XBULK	7334-6014	1.05	2000
G81995-0406	6SC-4	7334-60155	1.15	1
G81995-0406X	6SC-4 XBULK	7334-6015	1.15	400
G81995-0408	8SC-4	7334-60555	1.62	1
G81995-0408X	8SC-4 XBULK	7334-6055	1.62	200
G81995-0410	10SC-4	7334-60565	2.37	1
G81995-0410X	10SC-4 XBULK	7334-6056	2.37	200
G81995-0412	12SC-4	7334-60575	1.87	1
G81995-0412X	12SC-4 XBULK	7334-6057	1.87	150
G81995-0416	16SC-4	7334-60585	1.40	1



## Nylon Protective Sleeve

Do not use the Nylon Sleeve where ambient temperatures exceed 250°F.

Description: Gates Nylon Sleeves perform a dual role: (1) they provide excellent abrasion resistance to protect individual hose; and (2) they can be used to bundle several hose assemblies together for maximum protection. Downtime and maintenance costs are reduced. These Nylon Sleeves are unique because they form an extra protective layer against abrasive forces. Specifically, thousands of tiny Nylon filaments, woven into the texturized yarn, "friz" into a self-renewing shield that is extremely resistant to severe abrasion. This nylon sleeving has MSHA flame-resistance approval. Add 1/8" for installation.

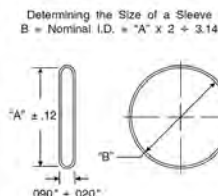

Part No.	Descr.	Prod. No.	A Inside Flat	B Sleeve I.D.	Standard Pack
			"	"	
G81800-0010	HG-10	7277-1067	1.07	.68	300
G81800-0014	HG-14	7277-1010	1.42	.90	300
G81800-0016	HG-16	7277-1011	1.67	1.06	300
G81800-0020	HG-20	7277-1012	1.92	1.22	300
G81800-0024	HG-24	7277-1013	2.24	1.42	300
G81800-0026	HG-26	7277-1377	2.50	1.59	300
G81800-0028	HG-28	7277-1014	2.85	1.81	300
G81800-0032	HG-32	7277-1015	3.44	2.19	300
G81800-0038	HG-38	7277-1016	3.74	2.38	300
G81800-0042	HG-42	7277-1018	4.12	2.62	300
G81800-0046	HG-46	7277-1024	4.53	2.88	300
G81800-0064	HG-64	7277-1276	6.91	4.40	100
G81801-0014	HG 14 X25FT	7277-1278	1.42	.90	25
G81801-0016	HG 16 X25FT	7277-1279	1.67	1.06	25
G81801-0020	HG 20 X25FT	7277-1280	1.92	1.22	25
G81801-0024	HG 24 X25FT	7277-1281	2.24	1.42	25
G81801-0026	HG 26 X25FT	7277-1378	2.50	1.59	25
G81801-0028	HG 28 X25FT	7277-1282	2.85	1.81	25
G81801-0032	HG 32 X25FT	7277-1283	3.44	2.19	25
G81801-0038	HG 38 X25FT	7277-1284	3.74	2.38	25

NOTE: Be sure to heat the cut edges of the Nylon Hose Sleeve. You may have to use a banded clamp or nylon tie to fasten the sleeve securely.

- EQUIPMENT
- HOSE/CPLG. SELECTION
- G8K COUPLINGS
- GLOBALSPIRAL COUPLINGS
- STAINLESS STEEL SPIRAL
- MEGACRIMP COUPLINGS
- STAINLESS STEEL BRAID
- POWER CRIMP COUPLINGS
- FIELD ATTACHABLE G1 & G2 COUPLINGS
- FIELD ATTACHABLE C5 COUPLINGS
- C14 COUPLINGS
- GL COUPLINGS
- GLX COUPLINGS
- PCTS THERMOPLASTIC COUPLINGS
- POLARSEAL COUPLINGS (ACA)
- POLARSEAL II COUPLINGS (ACC)
- POLARSEAL II COUPLINGS (ACB)
- POWER STEERING
- ADAPTERS
- QUICK DISCONNECT COUPLERS
- BALL VALVES
- LIVE SWIVEL
- ASSEMBLY FABRICATION
- ACCESSORIES
- EQUIPMENT AND PARTS
- KITS
- AIR BRAKE HOSE ASSY
- BRASS



## PolySleeve™ High Density Polyethylene Hose Wrap

Description: Gates PolySleeve is a spiral wrap designed to protect or bundle hose for appearance and safety. PolySleeve protects hose from chaffing, rubbing, crushing, ultraviolet rays and other hazards that cause hose failures. It can be an easy and economical way to protect equipment, reduce downtime, improve sighting and improve overall appearance. PolySleeve can be installed easily – even after the hose assembly or assemblies are in place. The edges are rounded, so installers won't cut their hands. Just wrap a section of Gates PolySleeve in the abrasion area or wrap it around any number of hose for better appearance or safety. It is offered in either black or yellow in a full range of sizes.

This product is made of heavy-wall, high-density polyethylene (HDPE) and has a wide temperature range. At -40°F it starts to become somewhat brittle, and at 280°F it starts to become soft. After temperature is normalized, PolySleeve returns to its original state quickly. PolySleeve is made with an anti-static material, so it won't build up a static charge.

Features Advantages: Available in two colors (black and yellow), multiple sizes for individual hose or bundling.

Comes with rounded edges both inside and out for added safety.

Easy to install before or after assembly fabrication or installation.

Effective temperature range from -40°F to +280°F (-40°C to +130°C).

Guards against harsh environmental conditions for reduced downtime.

Safe, affordable protection for hydraulic and pneumatic lines.



EQUIPMENT
HOSE/CPLG. SELECTION
G8K COUPLINGS
GLOBAL SPIRAL COUPLINGS
STAINLESS STEEL SPIRAL
MEGACRIMP COUPLINGS
STAINLESS STEEL BRAID
POWER CRIMP COUPLINGS
FIELD ATTACHABLE G1 & G2 COUPLINGS
FIELD ATTACHABLE C5 COUPLINGS
C14 COUPLINGS
GL COUPLINGS
GLX COUPLINGS
PCTS THERMOPLASTIC COUPLINGS
POLARSEAL COUPLINGS (ACA)
POLARSEAL II COUPLINGS (ACC)
POLARSEAL II COUPLINGS (ACB)
POWER STEERING
ADAPTERS
QUICK DISCONNECT COUPLERS
BALL VALVES
LIVE SWIVEL
ASSEMBLY FABRICATION
ACCESSORIES
EQUIPMENT AND PARTS
KITS
AIR BRAKE HOSE ASSY
BRASS

Part No.	Descr.	Prod. No.	Color	Coil I.D.	Fits Max. Hose O.D.	Fits Min. Hose O.D.	Wall Thickness	Width	Standard Pack
				"	"	"			
G80901-0006	6PSB POLY SLEEVE	7277-1174	Black	.38	.52	.38	.060	3/8	165
G80901-0008	8PSB POLY SLEEVE	7277-1175	Black	.50	.64	.52	.070	9/16	66
G80901-0012	12PSB POLY SLEEVE	7277-1176	Black	.63	.85	.63	.080	5/8	66
G80901-0016	16PSB POLY SLEEVE	7277-1177	Black	.84	1.08	.86	.080	7/8	66
G80901-0020	20PSB POLY SLEEVE	7277-1178	Black	1.06	1.35	1.10	.100	15/16	66
G80901-0024	24PSB POLY SLEEVE	7277-1179	Black	1.34	1.74	1.36	.120	1 3/16	66
G80901-0028	28PSB POLY SLEEVE	7277-1180	Black	1.73	2.18	1.75	.120	1 7/16	66
G80901-0036	36PSB POLY SLEEVE	7277-1181	Black	2.17	2.61	2.19	.160	1 1/2	66
G80901-0044	44PSB POLY SLEEVE	7277-1182	Black	2.60	3.11	2.62	.180	1 11/16	66
G80901-0048	48PSB POLY SLEEVE	7277-1183	Black	3.10	3.95	3.12	.220	1 7/8	66
G80901-0056	56PSB POLY SLEEVE	7277-1184	Black	3.90	4.25	3.95	.220	2 1/4	40
G80901-0072	72PSB POLY SLEEVE	7277-0001	Black	4.33	12.00	4.35	.220	1 3/8	40
G80902-0006	6PSY POLY SLEEVE	7277-1185	Yellow	.38	.52	.38	.060	3/8	165
G80902-0008	8PSY POLY SLEEVE	7277-1186	Yellow	.50	.64	.52	.070	9/16	66
G80902-0012	12PSY POLY SLEEVE	7277-1187	Yellow	.63	.85	.63	.080	5/8	66
G80902-0016	16PSY POLY SLEEVE	7277-1188	Yellow	.84	1.08	.86	.080	7/8	66
G80902-0020	20PSY POLY SLEEVE	7277-1189	Yellow	1.06	1.35	1.10	.100	15/16	66
G80902-0024	24PSY POLY SLEEVE	7277-1190	Yellow	1.34	1.74	1.36	.120	1 3/16	66
G80902-0028	28PSY POLY SLEEVE	7277-1191	Yellow	1.73	2.18	1.75	.120	1 7/16	66
G80902-0036	36PSY POLY SLEEVE	7277-1192	Yellow	2.17	2.61	2.19	.160	1 1/2	66
G80902-0044	44PSY POLY SLEEVE	7277-1193	Yellow	2.60	3.11	2.62	.180	1 11/16	66
G80902-0048	48PSY POLY SLEEVE	7277-1194	Yellow	3.10	3.95	3.12	.220	1 7/8	66
G80902-0056	56PSY POLY SLEEVE	7277-1195	Yellow	3.90	4.25	3.95	.220	2 1/4	40



## Plastic Protective Coil Sleeves

Description: Economical, lightweight plastic sleeving protects hose from water, air, gasoline and hydraulic fluids. Effective temperature range from -40°F to +250°F (-40°C to +121°C).



Part No.	Descr.	Prod. No.	A Coil I.D.	B Strip Width	Thickness	Standard Pack
			"	"	"	
G81900-0004	1/4" CS1151-100FT	7277-1151	1/4	1/4	.040	100
G81900-0006	3/8" CS1152-100FT	7277-1152	3/8	1/4	.040	100
G81900-0008	1/2" CS1153-100FT	7277-1153	1/2	3/8	.070	100
G81900-0010	5/8" CS1154-50FT	7277-1154	5/8	3/8	.070	50
G81900-0012	3/4" CS1155-50FT	7277-1155	3/4	3/8	.070	50
G81900-0016	1" CS1156-50FT	7277-1156	1	5/8	.115	50
G81900-0022	1 3/8" CS1157-25FT	7277-1157	1 3/8	5/8	.115	25
G81900-0030	1 7/8" CS1158-25FT	7277-1158	1 7/8	5/8	.115	25

## Plated Flat Armor Spring Guards

Description: For proper spring guard selection compare the outside diameter of the hose to the inside diameter of the spring guard. Allow 1/32" for installation.

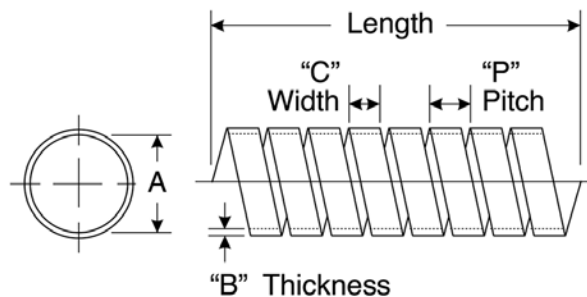

Part No.	Descr.	Prod. No.	A (+.015)	B	C	P	Standard Pack
			"	"	"	"	
G82801-0008	35/64" FSG-25FT	7277-0500	.550	.019	3/8	1/2	25
G82801-0009	21/32" FSG-25FT	7277-0501	.656	.019	3/8	1/2	25
G82801-0010	39/64" FSG-25FT	7277-0533	.609	.032	1/4	3/8	25
G82801-0011	22/32" FSG-25FT	7277-0502	.719	.019	3/8	1/2	25
G82801-0012	13/16" FSG-25FT	7277-0503	.812	.028	1/4	3/8	25
G82801-0013	51/64" FSG-25FT	7277-0534	.797	.032	3/8	1/2	25
G82801-0014	7/8" FSG-25FT	7277-0504	.875	.028	1/2	5/8	25
G82801-0015	61/64" FSG-25FT	7277-0505	.953	.028	1/2	5/8	25
G82801-0016	1" FSG-25FT	7277-0506	1.000	.028	1/2	5/8	25
G82801-0017	1 3/32" FSG-25FT	7277-0530	1.093	.028	1/2	5/8	25
G82801-0019	1 7/32" FSG-25FT	7277-0507	1.219	.028	1/2	5/8	25
G82801-0020	1 9/32" FSG-25FT	7277-0508	1.281	.028	1/2	5/8	25
G82801-0022	1 3/8" FSG-25FT	7277-0532	1.375	.028	1/2	5/8	25
G82801-0025	1 9/16" FSG-25FT	7277-0520	1.562	.028	1/2	5/8	25
G82801-0026	1 5/8" FSG-25FT	7277-0509	1.625	.028	1/2	5/8	25

- EQUIPMENT
- HOSE/CPLG. SELECTION
- G8K COUPLINGS
- GLOBALSPIRAL COUPLINGS
- STAINLESS STEEL SPIRAL
- MEGACRIMP COUPLINGS
- STAINLESS STEEL BRAID
- POWER CRIMP COUPLINGS
- FIELD ATTACHABLE G1 & G2 COUPLINGS
- FIELD ATTACHABLE C5 COUPLINGS
- C14 COUPLINGS
- GL COUPLINGS
- GLX COUPLINGS
- PCTS THERMOPLASTIC COUPLINGS
- POLARSEAL COUPLINGS (ACA)
- POLARSEAL II COUPLINGS (ACC)
- POLARSEAL II COUPLINGS (ACB)
- POWER STEERING
- ADAPTERS
- QUICK DISCONNECT COUPLERS
- BALL VALVES
- LIVE SWIVEL
- ASSEMBLY FABRICATION
- ACCESSORIES
- EQUIPMENT AND PARTS
- KITS
- AIR BRAKE HOSE ASSY
- BRASS



### Plated Flat Armor Spring Guards - Continued

Part No.	Descr.	Prod. No.	A (+.015)	B	C	P	Standard Pack
			"	"	"	"	
G82801-0027	1 11/16" FSG-5FT	7277-0529	1.687	.028	1/2	5/8	5
G82801-0028	1 51/64" FSG-15FT	7277-0525	1.797	.028	1/2	5/8	15
G82801-0029	1 27/32" FSG-15FT	7277-0531	1.844	.028	1/2	5/8	15
G82801-0033	2 3/32" FSG-10FT	7277-0527	2.093	.028	1/2	5/8	10
G82801-0037	2 11/32" FSG-5FT	7277-0528	2.343	.028	1/2	5/8	5
G82801-0046	2 7/8" FSG-5FT	7277-0526	2.875	.028	1/2	5/8	5

### Plated Wire Spring Guards

Description: For proper spring guard selection compare the outside diameter of the hose to the inside diameter of the spring guard. Allow 1/32" for installation.

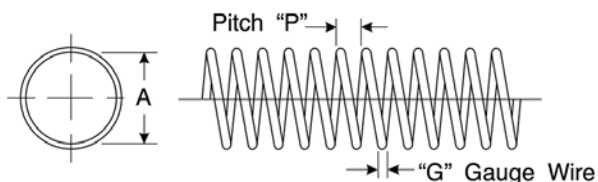

Part No.	Descr.	Prod. No.	A (+.015)	G	P	Standard Pack
			"	"	"	
G83801-0009	35/64" RSG-25FT	7277-0521	.550	14 (.080)	7/32	25
G83801-0010	49/64" RSG-25FT	7277-0510	.676	14 (.080)	7/32	25
G83801-0011	11/16" RSG-25FT	7277-0535	.682	16 (.065)	7/32	25
G83801-0012	47/64" RSG-25FT	7277-0511	.738	14 (.080)	7/32	25
G83801-0014	55/64" RSG-25FT	7277-0512	.852	14 (.080)	7/32	25
G83801-0015	59/64" RSG-25FT	7277-0513	.915	14 (.080)	7/32	25
G83801-0016	63/64" RSG-25FT	7277-0514	.977	14 (.080)	7/32	25
G83801-0017	1 3/64" RSG-25FT	7277-0515	1.040	14 (.080)	7/32	25
G83801-0018	1 1/8" RSG-25FT	7277-0522	1.122	14 (.080)	7/32	25
G83801-0020	1 9/32" RSG-25FT	7277-0516	1.278	11 (.120)	11/32	25
G83801-0021	1 11/32" RSG-25FT	7277-0517	1.340	11 (.120)	11/32	25
G83801-0025	1 37/64" RSG-25FT	7277-0518	1.578	11 (.120)	11/32	25
G83801-0026	1 5/8" RSG-25FT	7277-0519	1.625	11 (.120)	11/32	25
G83801-0029	1 27/32" RSG-10FT	7277-0524	1.847	14 (.080)	13/32	10
G83801-0034	2 1/8" RSG-7FT	7277-0548	2.120	11 (.120)	11/32	7
G83801-0040	2 7/64" RSG-7FT	7277-0523	2.112	14 (.080)	13/32	7

EQUIPMENT
HOSE/CPLG. SELECTION
G8K COUPLINGS
GLOBAL SPIRAL COUPLINGS
STAINLESS STEEL SPIRAL
MEGACRIMP COUPLINGS
STAINLESS STEEL BRAID
POWER CRIMP COUPLINGS
FIELD ATTACHABLE G1 & G2 COUPLINGS
FIELD ATTACHABLE C5 COUPLINGS
C14 COUPLINGS
GL COUPLINGS
GLX COUPLINGS
PCTS THERMOPLASTIC COUPLINGS
POLARSEAL COUPLINGS (ACA)
POLARSEAL II COUPLINGS (ACC)
POLARSEAL II COUPLINGS (ACB)
POWER STEERING
ADAPTERS
QUICK DISCONNECT COUPLERS
BALL VALVES
LIVE SWIVEL
ASSEMBLY FABRICATION
ACCESSORIES
EQUIPMENT AND PARTS
KITS
AIR BRAKE HOSE ASSY
BRASS





## HeatGuard® Tape

Description: HeatGuard Tape is designed to provide a non-adhesive insulating wrap that can be used as a substitute for HeatGuard protective sheathing, offering resistance to molten metal splash, radiant heat, abrasion, corrosive atmosphere, moisture, chemicals, vibration and electricity. HeatGuard Tape is white knitted fiberglass yarn woven in a flat strip and coated on one side with iron oxide red silicone rubber with a nominal thickness of 0.147".

Temperature Range: Rated for 500°F (260°C) continuous exposure, up to 2000°F (1093°C) for 15–20 minutes and up to 3000°F (1650°C) for 15–30 seconds.



Part No.	Prod. No.	Descr.	Standard Pack
G81100-0100	7277-0010	HTG-1" Wide HeatGuard Tape	100
G81100-0200	7277-0011	HTG-2" Wide HeatGuard Tape	100
G81100-0300	7277-0012	HTG-3" Wide HeatGuard Tape	100
G81100-0400	7277-0013	HTG-4" Wide HeatGuard Tape	100
G81100-0500	7277-0014	HTG-5" Wide HeatGuard Tape	100

## HeatGuard® Protective Sheathing

Description: Best of all, HeatGuard can pay for itself in reduced replacement and maintenance costs. It is available in two grades – HeatGuard and HeatGuard Hi-Temp. Contact Hose Product Application for details. HeatGuard is a completely not-asbestos, heat-resistant, protective sleeving. It goes on easily over most hose and couplings, with only hose clamps or wire ties required for fastening. Nominal wall thickness – 0.135".

Temperature Range: HeatGuard coated fiberglass; -65°F to +500°F (-54°C to +260°C).

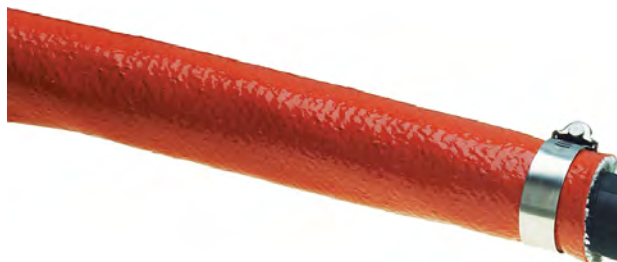

Part No.	Descr.	Prod. No.	Inside Diameter	Standard Pack
			"	
G81100-0004	HTG-4	7277-1571	.25	50
G81100-0005	HTG-5	7277-1572	.31	50
G81100-0006	HTG-6	7277-1573	.38	50
G81100-0007	HTG-7	7277-1574	.44	50
G81100-0008	HTG-8	7277-1575	.50	50
G81100-0009	HTG-9	7277-1576	.56	50
G81100-0010	HTG-10	7277-1577	.62	50
G81100-0011	HTG-11	7277-1578	.69	50
G81100-0012	HTG-12	7277-1579	.75	50
G81100-0013	HTG-13	7277-1580	.81	50
G81100-0014	HTG-14	7277-1581	.88	50
G81100-0015	HTG-15	7277-1582	.94	50

- EQUIPMENT
- HOSE/CPLG. SELECTION
- G8K COUPLINGS
- GLOBALSPIRAL COUPLINGS
- STAINLESS STEEL SPIRAL
- MEGACRIMP COUPLINGS
- STAINLESS STEEL BRAID
- POWER CRIMP COUPLINGS
- FIELD ATTACHABLE G1 & G2 COUPLINGS
- FIELD ATTACHABLE C5 COUPLINGS
- C14 COUPLINGS
- GL COUPLINGS
- GLX COUPLINGS
- PCTS THERMOPLASTIC COUPLINGS
- POLARSEAL COUPLINGS (ACA)
- POLARSEAL II COUPLINGS (ACC)
- POLARSEAL II COUPLINGS (ACB)
- POWER STEERING
- ADAPTERS
- QUICK DISCONNECT COUPLERS
- BALL VALVES
- LIVE SWIVEL
- ASSEMBLY FABRICATION
- ACCESSORIES
- EQUIPMENT AND PARTS
- KITS
- AIR BRAKE HOSE ASSY
- BRASS



### HeatGuard® Protective Sheathing - Continued

EQUIPMENT
HOSE/CPLG. SELECTION
G8K COUPLINGS
GLOBAL SPIRAL COUPLINGS
STAINLESS STEEL SPIRAL
MEGACRIMP COUPLINGS
STAINLESS STEEL BRAID
POWER CRIMP COUPLINGS
FIELD ATTACHABLE G1 & G2 COUPLINGS
FIELD ATTACHABLE C5 COUPLINGS
C14 COUPLINGS
GL COUPLINGS
GLX COUPLINGS
PCTS THERMOPLASTIC COUPLINGS
POLARSEAL COUPLINGS (ACA)
POLARSEAL II COUPLINGS (ACC)
POLARSEAL II COUPLINGS (ACB)
POWER STEERING
ADAPTERS
QUICK DISCONNECT COUPLERS
BALL VALVES
LIVE SWIVEL
ASSEMBLY FABRICATION
ACCESSORIES
EQUIPMENT AND PARTS
KITS
AIR BRAKE HOSE ASSY
BRASS

Part No.	Descr.	Prod. No.	Inside Diameter	Standard Pack
			"	
G81100-0016	HTG-16	7277-1196	1.00	50
G81100-0018	HTG-18	7277-1197	1.12	50
G81100-0020	HTG-20	7277-1583	1.25	50
G81100-0022	HTG-22	7277-1584	1.38	50
G81100-0024	HTG-24	7277-1585	1.50	50
G81100-0026	HTG-26	7277-1586	1.62	50
G81100-0028	HTG-28	7277-1587	1.75	50
G81100-0030	HTG-30	7277-1588	1.88	50
G81100-0032	HTG-32	7277-1589	2.00	50
G81100-0034	HTG-34	7277-1590	2.12	50
G81100-0036	HTG-36	7277-1591	2.25	50
G81100-0038	HTG-38	7277-1592	2.38	50
G81100-0040	HTG-40	7277-1593	2.50	50
G81100-0044	HTG-44	7277-1595	2.75	50
G81100-0056	HTG-56	7277-1600	3.50	50
G81100-0064	HTG-64	7277-1602	4.00	50

### HeatGuard® High-Temp Protective Sheathing

Description: HeatGuard Hi-Temp is a completely not-asbestos, heat-resistant, protective sleeving. It goes on easily over most hose and couplings, with only hose clamps or wire ties required for fastening. Nominal wall thickness – 0.142". It is available in two grades – HeatGuard and HeatGuard Hi-Temp. Contact Hose Product Application for details.

It is available in two grades – HeatGuard and HeatGuard Hi-Temp. Contact Hose Product Application for details.

Temperature Range: HeatGuard Hi-Temp is braided, coated fiberglass; meets SAE AS1072E specification; temperature range: -65°F to +500°F (-54°C to +260°C) for continuous exposure, up to 2000°F (1093°C) for 15–20 minutes and up to 3000°F (1650°C) for 15–30 seconds.

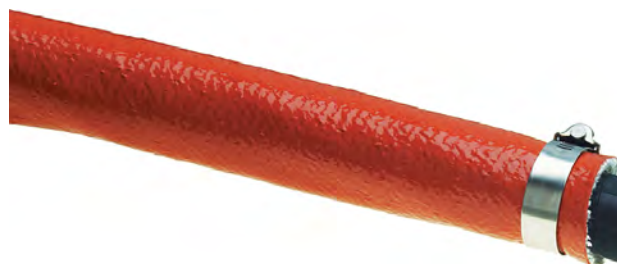

Part No.	Descr.	Prod. No.	Inside Diameter	Standard Pack
			"	
G81101-0024	24-HTGH	7277-1611	1.50	50
G81101-0028	28-HTGH	7277-1612	1.75	50
G81101-0034	34-HTGH	7277-1613	2.12	50
G81101-0052	52-HTGH	7277-1616	3.25	50



## Clamp Collars

Description: Crimping Instruction: Care must be taken when crimping clamp collars onto a hydraulic hose. If crimp is too tight, hose will be crushed, dramatically reducing its service life. If crimp is too loose, collar could slide along hose's length causing abrasion and eventual hose cover failure. Remember: Clamp collars must be crimped before the hose couplings.

To locate clamps and protect hose. Previously available only through equipment dealerships, clamp collars are common on many types of construction equipment. The collars are actually crimped onto a hydraulic hose, reducing hose movement and minimizing abrasion.

Use the following instruction to determine crimp diameter, which can then be used to find crimping setting in Gates Crimp Data Manual (428-7365 Auto./35019 Ind.). The required clamp collar for a specific hydraulic hose is provided in Table 1. 1. Measure hose's outside diameter at the location where clamp collar will be crimped. This can be accomplished by using a pie tape or by using the average hose outside diameter measured with a dial caliper. 2. Measure wall thickness of clamp collar with a dial caliper. 3. Obtain crimp diameter by adding hose outside diameter to twice the clamp collar wall thickness; Crimp Diameter = (Hose O.D.) + (2 x .065).



Part No.	Descr.	Prod. No.	Hydraulic Hose Applications
G52000-0210	CC1.12	7334-45805	10M2T, 10G2, 10M3K
G52000-0210S	CC1.20	7334-37015	12M2T, 12G2, 12M4K
G52000-0212	CC1.25	7334-45885	12M2T, 12G2, 12M4K
G52000-0412	CC1.37	7334-45895	12C12, 12G4K

- EQUIPMENT
- HOSE/CPLG. SELECTION
- G8K COUPLINGS
- GLOBALSPIRAL COUPLINGS
- STAINLESS STEEL SPIRAL
- MEGACRIMP COUPLINGS
- STAINLESS STEEL BRAID
- POWER CRIMP COUPLINGS
- FIELD ATTACHABLE G1 & G2 COUPLINGS
- FIELD ATTACHABLE C5 COUPLINGS
- C14 COUPLINGS
- GL COUPLINGS
- GLX COUPLINGS
- PCTS THERMOPLASTIC COUPLINGS
- POLARSEAL COUPLINGS (ACA)
- POLARSEAL II COUPLINGS (ACC)
- POLARSEAL II COUPLINGS (ACB)
- POWER STEERING
- ADAPTERS
- QUICK DISCONNECT COUPLERS
- BALL VALVES
- LIVE SWIVEL
- ASSEMBLY FABRICATION
- ACCESSORIES
- EQUIPMENT AND PARTS
- KITS
- AIR BRAKE HOSE ASSY
- BRASS



## Vinyl Bend Restrictor

Description: Gates tapered PVC sleeve reduces bending stress in the hose near the coupling to prevent damage, such as in power wash applications. Installed during hose assembly, this smoothly-finished product withstands temperatures from -40°F to +200°F (-40°C to +93°C).

Features Advantages: Friction Fit: no adhesives or clamps required to hold bend restrictor in place on hose assembly. Saves assembly cost. Smooth finish will not scratch finish on equipment being washed. Attractive appearance enhances look of quality. Tapered design reduces bending stress neat the hose-coupling junction so extra-long, more trouble-free hose life can be expected. Wide temperature helps give extra-long service life for both hot and cold power wash assemblies.



	Part No.	Descr.	Prod. No.	Color	Inside Diameter	Length	Hose Size and Type	Standard Pack
					"	"		
FIELD ATTACHABLE G1 & G2 COUPLINGS	G80700-0106	HBR1051	7277-10515	Black	.73	6.0	6G1, 6G1H, 6M3K, 6M2T, 6PC3000, 6PC4000, 4PC6000	27
FIELD ATTACHABLE C5 COUPLINGS	G80700-0106X	HBR1051 XBULK	7277-1051	Black	.73	6.0	6G1, 6G1H, 6M3K, 6M2T, 6PC3000, 6PC4000, 4PC6000	380
C14 COUPLINGS	G80700-0108	HBR1052	7277-10525	Black	.84	7.00	8G1, 8G1H, 6PC5000	38
GL COUPLINGS	G80700-0108X	HBR1052 XBULK	7277-1052	Black	.84	7.00	8G1, 8G1H, 6PC5000	200
GLX COUPLINGS	G80700-0110	HBR1053	7277-10535	Black	1.00	8.0	10G1, 10G1H, 10M2T	30
	G80700-0110X	HBR1053 XBULK	7277-1053	Black	1.00	8.0	10G1, 10G1H, 10M2T	150
	G80700-0204	HBR1050	7277-10505	Black	.63	5.5	4G1, 4G1H, 4G2, 4M3K, 4M2T, 4PC3500	39
	G80700-0204X	HBR1050 XBULK	7277-1050	Black	.63	5.5	4G1, 4G1H, 4G2, 4M3K, 4M2T, 4PC3500	410
PCTS THERMOPLASTIC COUPLINGS	G80700-0206	HBR1054	7277-10545	Black	.77	7.00	6G2	45
	G80700-0206X	HBR1054 XBULK	7277-1054	Black	.77	7.00	6G2	300
	G80700-0208	HBR1056	7277-10905	Black	.91	7.00	8PC2500	34
POLARSEAL COUPLINGS (ACA)	G80700-0404	HBR1055	7277-10555	Black	.53	5.3	4TH7/4TH7NC	42
	G80700-0404X	HBR1055 XBULK	7277-1055	Black	.53	5.3	4TH7/4TH7NC	440
	G80705-0108	HBR1098	7277-10985	Red	.91	7.00	8PC2500	34
POLARSEAL II COUPLINGS (ACC)	G80705-0108X	HBR1098 XBULK	7277-1098	Red	.91	7.00	8PC2500	190
	G80705-0206	HBR1097	7277-10975	Red	.76	7.00	6G2	45
	G80705-0206X	HBR1097 XBULK	7277-1097	Red	.76	7.00	6G2	300

EQUIPMENT
HOSE/CPLG. SELECTION
G8K COUPLINGS
GLOBAL SPIRAL COUPLINGS
STAINLESS STEEL SPIRAL
MEGACRIMP COUPLINGS
STAINLESS STEEL BRAID
POWER CRIMP COUPLINGS
FIELD ATTACHABLE G1 & G2 COUPLINGS
FIELD ATTACHABLE C5 COUPLINGS
C14 COUPLINGS
GL COUPLINGS
GLX COUPLINGS
PCTS THERMOPLASTIC COUPLINGS
POLARSEAL COUPLINGS (ACA)
POLARSEAL II COUPLINGS (ACC)
POLARSEAL II COUPLINGS (ACB)
POWER STEERING
ADAPTERS
QUICK DISCONNECT COUPLERS
BALL VALVES
LIVE SWIVEL
ASSEMBLY FABRICATION
ACCESSORIES
EQUIPMENT AND PARTS
KITS
AIR BRAKE HOSE ASSY
BRASS



### Code 61 Flange Cap

For maintenance use only. Not to be used under pressure.

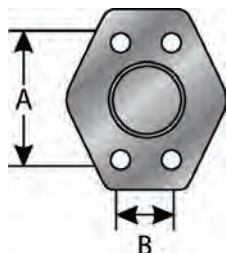

Part No.	Descr.	Prod. No.	Nom. Flg. Size	A	B	Standard Pack
			"	"	"	
G60897-0012	12FL-CAP	7253-66115	3/4	1.88	.41	1
G60897-0016	16FL-CAP	7253-66125	1	2.06	.41	1
G60897-0020	20FL-CAP	7253-66135	1 1/4	2.31	.47	1
G60897-0024	24FL-CAP	7253-66145	1 1/2	2.75	.53	1
G60897-0032	32FL-CAP	7253-66155	2	3.06	.53	1

### Flange Half Sets (Code 61 - SAE J518)

Each set contains 2 flange halves, 1 O-Ring and 4 bolts (Grade 8) with lock washers.



Part No.	Descr.	Prod. No.	Nom. Flg. Size	A	B	Standard Pack
			"	"	"	
G60899-0008	8CFHS	7253-07015	1/2	1.50	.34	1
G60899-0012	12CFHS	7253-07025	3/4	1.88	.41	1
G60899-0016	16CFHS	7253-07035	1	2.06	.41	1
G60899-0020	20CFHS	7253-07045	1 1/4	2.31	.47	1
G60899-0024	24CFHS	7253-07055	1 1/2	2.75	.53	1
G60899-0032	32CFHS	7253-07065	2	3.06	.53	1
G60899-0040	40CFHS	7253-01305	2 1/2	3.50	.54	1
G60899-0048	48CFHS	7253-01315	3	4.19	.66	1
G60899-0056	56CFHS	7253-01325	3 1/2	4.75	.66	1
G60899-0064	64CFHS	7253-01335	4	4.75	.66	1

- EQUIPMENT
- HOSE/CPLG. SELECTION
- G8K COUPLINGS
- GLOBALSPIRAL COUPLINGS
- STAINLESS STEEL SPIRAL
- MEGACRIMP COUPLINGS
- STAINLESS STEEL BRAID
- POWER CRIMP COUPLINGS
- FIELD ATTACHABLE G1 & G2 COUPLINGS
- FIELD ATTACHABLE C5 COUPLINGS
- C14 COUPLINGS
- GL COUPLINGS
- GLX COUPLINGS
- PCTS THERMOPLASTIC COUPLINGS
- POLARSEAL COUPLINGS (ACA)
- POLARSEAL II COUPLINGS (ACC)
- POLARSEAL II COUPLINGS (ACB)
- POWER STEERING
- ADAPTERS
- QUICK DISCONNECT COUPLERS
- BALL VALVES
- LIVE SWIVEL
- ASSEMBLY FABRICATION
- ACCESSORIES
- EQUIPMENT AND PARTS
- KITS
- AIR BRAKE HOSE ASSY
- BRASS



EQUIPMENT
HOSE/CPLG. SELECTION
G8K COUPLINGS
GLOBAL SPIRAL COUPLINGS
STAINLESS STEEL SPIRAL
MEGACRIMP COUPLINGS
STAINLESS STEEL BRAID
POWER CRIMP COUPLINGS
FIELD ATTACHABLE G1 & G2 COUPLINGS
FIELD ATTACHABLE C5 COUPLINGS
C14 COUPLINGS
GL COUPLINGS
GLX COUPLINGS
PCTS THERMOPLASTIC COUPLINGS
POLARSEAL COUPLINGS (ACA)
POLARSEAL II COUPLINGS (ACC)
POLARSEAL II COUPLINGS (ACB)
POWER STEERING
ADAPTERS
QUICK DISCONNECT COUPLERS
BALL VALVES
LIVE SWIVEL
ASSEMBLY FABRICATION
ACCESSORIES
EQUIPMENT AND PARTS
KITS
AIR BRAKE HOSE ASSY
BRASS

### Code 62 Flange Cap

For maintenance use only. Not to be used under pressure.

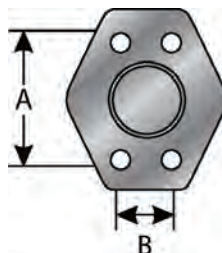

Part No.	Descr.	Prod. No.	Nom. Flg. Size	A	B	Standard Pack
			"	"	"	
G60927-0012	12FLH-CAP	7253-66165	3/4	2.00	.41	1
G60927-0016	16FLH-CAP	7253-66175	1	2.25	.47	1
G60927-0020	20FLH-CAP	7253-66185	1 1/4	2.63	.53	1
G60927-0024	24FLH-CAP	7253-66195	1 1/2	3.13	.66	1
G60927-0032	32FLH-CAP	7253-66205	2	3.81	.78	1

### Flange Half Sets (Code 62 - SAE J518)

Each set contains 2 flange halves, 1 O-Ring and 4 bolts (Grade 8) with lock washers.



Part No.	Descr.	Prod. No.	Nom. Flg. Size	A	B	Standard Pack
			"	"	"	
G60929-0008	8FHHS	7253-09775	1/2	1.55	.34	1
G60929-0012	12FHHS	7253-09785	3/4	2.00	.41	1
G60929-0016	16FHHS	7253-09795	1	2.25	.47	1
G60929-0020	20FHHS	7253-09805	1 1/4	2.63	.53	1
G60929-0024	24FHHS	7253-09815	1 1/2	3.13	.66	1
G60929-0032	32FHHS	7253-09825	2	3.81	.78	1



### Caterpillar-Style Flange Half Sets

Each set contains 2 flange halves, 1 O-Ring and 4 bolts (Grade 8) with lock washers.

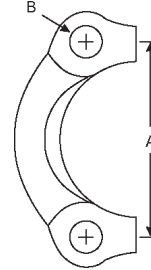
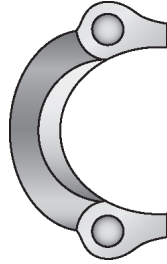

Part No.	Descr.	Prod. No.	Nom. Flg. Size	A	B	Standard Pack
			"	"	"	
G60959-0012	12CATFHS	7253-37025	3/4	2.00	.41	1
G60959-0016	16CATFHS	7253-37035	1	2.25	.47	1
G60959-0020	20CATFHS	7253-37045	1 1/4	2.63	.53	1
G60959-0024	24CATFHS	7253-37055	1 1/2	3.13	.66	1
G60959-0032	32CATFHS	7253-37065	2	3.81	.78	1

- EQUIPMENT
- HOSE/CPLG. SELECTION
- G8K COUPLINGS
- GLOBALSPIRAL COUPLINGS
- STAINLESS STEEL SPIRAL
- MEGACRIMP COUPLINGS
- STAINLESS STEEL BRAID
- POWER CRIMP COUPLINGS
- FIELD ATTACHABLE G1 & G2 COUPLINGS
- FIELD ATTACHABLE C5 COUPLINGS
- C14 COUPLINGS
- GL COUPLINGS
- GLX COUPLINGS
- PCTS THERMOPLASTIC COUPLINGS
- POLARSEAL COUPLINGS (ACA)
- POLARSEAL II COUPLINGS (ACC)
- POLARSEAL II COUPLINGS (ACB)
- POWER STEERING
- ADAPTERS
- QUICK DISCONNECT COUPLERS
- BALL VALVES
- LIVE SWIVEL
- ASSEMBLY FABRICATION
- ACCESSORIES
- EQUIPMENT AND PARTS
- KITS
- AIR BRAKE HOSE ASSY
- BRASS



## O-Rings for Straight Thread Boss Fittings

90 Durometer Hardness.



Part No.	Descr.	Prod. No.	Inside Diameter	Wall Thickness	Standard Pack
			"	"	
G60248-0003	3 O-RING	7254-0003	19/64	1/16	10
G60248-0004	4 O-RING	7254-0004	11/32	5/64	10
G60248-0005	5 O-RING	7254-0005	13/32	5/64	10
G60248-0006	6 O-RING	7254-0006	15/32	5/64	10
G60248-0008	8 O-RING	7254-0008	41/64	3/32	10
G60248-0010	10 O-RING	7254-0010	3/4	3/32	10
G60248-0012	12 O-RING	7254-0012	59/64	7/64	10
G60248-0014	14 O-RING	7254-0014	1 3/64	7/64	10
G60248-0016	16 O-RING	7254-0016	1 11/64	7/64	10
G60248-0020	20 O-RING	7254-0020	1 15/32	7/64	10

## O-Rings for Flat-Face Fittings

90 Durometer Hardness.

Caution: DO NOT USE these O-Rings with phosphate esters, diesters or phosphate ester emulsion hydraulic fluids. Instead, use O-Rings made of Viton, EPDM or CPE polymers or other materials compatible with the fluids.

These O-Rings are compounded from a Nitrile polymer for use with petroleum-based hydraulic fluids, water and glycol and oil-water emulsions.



Part No.	Descr.	Prod. No.	Reference Coupling	Arp. No.	Standard Pack
			"		
G60698-0004	4 O-RING FF	7254-0125	1/4	011	10
G60698-0006	6 O-RING FF	7254-0126	3/8	012	10
G60698-0008	8 O-RING FF	7254-0127	1/2	014	10
G60698-0010	10 O-RING FF	7254-0128	5/8	016	10
G60698-0012	12 O-RING FF	7254-0129	3/4	018	10
G60698-0016	16 O-RING FF	7254-0130	1	021	10
G60698-0020	20 O-RING FF	7254-0131	1 1/4	025	10
G60698-0024	24 O-RING FF	7254-0132	1 1/2	029	10

NOTE: Standard O-Ring number.

EQUIPMENT
HOSE/CPLG. SELECTION
G8K COUPLINGS
GLOBAL SPIRAL COUPLINGS
STAINLESS STEEL SPIRAL
MEGACRIMP COUPLINGS
STAINLESS STEEL BRAID
POWER CRIMP COUPLINGS
FIELD ATTACHABLE G1 & G2 COUPLINGS
FIELD ATTACHABLE C5 COUPLINGS
C14 COUPLINGS
GL COUPLINGS
GLX COUPLINGS
PCTS THERMOPLASTIC COUPLINGS
POLARSEAL COUPLINGS (ACA)
POLARSEAL II COUPLINGS (ACC)
POLARSEAL II COUPLINGS (ACB)
POWER STEERING
ADAPTERS
QUICK DISCONNECT COUPLERS
BALL VALVES
LIVE SWIVEL
ASSEMBLY FABRICATION
ACCESSORIES
EQUIPMENT AND PARTS
KITS
AIR BRAKE HOSE ASSY
BRASS





## O-Rings for Code 61, Code 62, and Caterpillar-Style Flange Fittings

90 Durometer Hardness.



Part No.	Descr.	Prod. No.	Inside Diameter	Wall Thickness	Standard Pack
			"	"	
G60898-0008	8 FLANGE O-RING	7254-0001	3/4	.139	10
G60898-0010	10 FLANGE O-RING	7254-0142	55/64	.139	10
G60898-0012	12 FLANGE O-RING	7254-0007	1.00	.139	10
G60898-0016	16 FLANGE O-RING	7254-0009	1 5/16	.139	10
G60898-0020	20 FLANGE O-RING	7254-0011	1 1/2	.139	10
G60898-0024	24 FLANGE O-RING	7254-0013	1 7/8	.139	10
G60898-0032	32 FLANGE O-RING	7254-0015	2 1/4	.139	10
G60898-0040X	40 FLANGE O-RING	7254-0133	2 3/4	.139	10
G60898-0048	48 FLANGE O-RING	7254-0134	3 3/8	.139	10
G60898-0056	56 FLANGE O-RING	7254-0135	3 7/8	.139	10
G60898-0064X	64 FLANGE O-RING	7254-0136	4 3/8	.139	10

## O-Rings for British Standard Parallel Pipe (BSPP Couplings)

70 Durometer Hardness.



Part No.	Descr.	Prod. No.	Inside Diameter	Wall Thickness	Standard Pack
			mm	mm	
G64095-0004	4 O-RING FBSPP	7254-1166	5.5	1.0	10
G64095-0006	6 O-RING FBSPP	7254-1154	7.1	1.6	10
G64095-0008	8 O-RING FBSPP	7254-1157	11.1	1.6	10
G64095-0010	10 O-RING FBSPP	7254-1159	12.1	1.6	10
G64095-0012	12 O-RING FBSPP	7254-1162	15.1	1.6	10
G64095-0016	16 O-RING FBSPP	7254-1164	20.1	1.6	10
G64095-0020	20 O-RING FBSPP	7254-1165	27.1	1.6	10

EQUIPMENT
HOSE/CPLG. SELECTION
G8K COUPLINGS
GLOBALSPIRAL COUPLINGS
STAINLESS STEEL SPIRAL
MEGACRIMP COUPLINGS
STAINLESS STEEL BRAID
POWER CRIMP COUPLINGS
FIELD ATTACHABLE G1 & G2 COUPLINGS
FIELD ATTACHABLE C5 COUPLINGS
C14 COUPLINGS
GL COUPLINGS
GLX COUPLINGS
PCTS THERMOPLASTIC COUPLINGS
POLARSEAL COUPLINGS (ACA)
POLARSEAL II COUPLINGS (ACC)
POLARSEAL II COUPLINGS (ACB)
POWER STEERING
ADAPTERS
QUICK DISCONNECT COUPLERS
BALL VALVES
LIVE SWIVEL
ASSEMBLY FABRICATION
ACCESSORIES
EQUIPMENT AND PARTS
KITS
AIR BRAKE HOSE ASSY
BRASS



EQUIPMENT
HOSE/CPLG. SELECTION
G8K COUPLINGS
GLOBALSPIRAL COUPLINGS
STAINLESS STEEL SPIRAL
MEGACRIMP COUPLINGS
STAINLESS STEEL BRAID
POWER CRIMP COUPLINGS
FIELD ATTACHABLE G1 & G2 COUPLINGS
FIELD ATTACHABLE C5 COUPLINGS
C14 COUPLINGS
GL COUPLINGS
GLX COUPLINGS
PCTS THERMOPLASTIC COUPLINGS
POLARSEAL COUPLINGS (ACA)
POLARSEAL II COUPLINGS (ACC)
POLARSEAL II COUPLINGS (ACB)
POWER STEERING
ADAPTERS
QUICK DISCONNECT COUPLERS
BALL VALVES
LIVE SWIVEL
ASSEMBLY FABRICATION
ACCESSORIES
EQUIPMENT AND PARTS
KITS
AIR BRAKE HOSE ASSY
BRASS

## O-Rings for DIN Light & Heavy Series (MegaCrimp® and GlobalSpiral™ Couplings)

70 Durometer Hardness.



Part No.	Descr.	Prod. No.	Inside Diameter	Wall Thickness	Standard Pack
			mm	mm	
G64780-0018	18 O-RING DIN L	7254-0201	15.0	2.0	10
G64780-0022	22 O-RING DIN L	7254-0202	20.0	2.0	10
G64780-0028	28 O-RING DIN L	7254-0203	26.0	2.0	10
G64780-0035	35 O-RING DIN L	7254-0204	32.0	2.5	10
G64780-0042	42 O-RING DIN L	7254-0205	38.0	2.5	10
G64781-0006	6 O-RING DIN H	7254-0206	4.0	1.5	10
G64781-0008	8 O-RING DIN H	7254-0207	6.0	1.5	10
G64781-0010	10 O-RING DIN H	7254-0208	7.5	1.5	10
G64781-0012	12 O-RING DIN H	7254-0209	9.0	1.5	10
G64781-0014	14 O-RING DIN H	7254-1132	10.0	2.0	10
G64781-0016	15/16 O-RING DIN L/H	7254-0200	12.0	2.0	10
G64781-0020	20 O-RING DIN H	7254-0210	16.3	2.4	10
G64781-0025	25 O-RING DIN H	7254-0211	20.3	2.4	10
G64781-0030	30 O-RING DIN H	7254-0212	25.3	2.4	10
G64781-0038	38 O-RING DIN H	7254-0213	33.3	2.4	10

## O-Rings for DIN Heavy Series (MegaCrimp® and GlobalSpiral™ Couplings)

70 Durometer Hardness.



Part No.	Descr.	Prod. No.	Inside Diameter	Wall Thickness	Standard Pack
			mm	mm	
G64782-0008	8 O-RING DIN H	7254-0154	6.0	1.5	10
G64782-0010	10 O-RING DIN H	7254-0151	7.1	1.6	10
G64782-0012	12 O-RING DIN H	7254-0153	9.1	1.6	10
G64782-0014	14 O-RING DIN H	7254-0150	10.5	1.8	10
G64782-0016	16 O-RING DIN H	7254-0149	11.9	1.8	10
G64782-0020	20 O-RING DIN H	7254-0152	16.6	2.4	10
G64782-0025	25 O-RING DIN H	7254-0144	21.6	2.4	10
G64782-0030	30 O-RING DIN H	7254-0146	27.6	2.4	10
G64782-0038	38 O-RING DIN H	7254-0145	34.6	2.4	10



### Female Flareless Nut

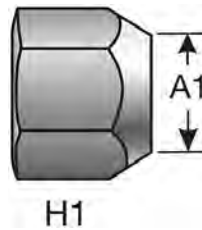

Part No.	Descr.	Prod. No.	A1		H1	Standard Pack
			"	"	"	
G60050-0004	4FFN	7334-40495	1/4	7/16-20	9/16	5
G60050-0005	5FFN	7334-40505	5/16	1/2-20	5/8	5
G60050-0006	6FFN	7334-40515	3/8	9/16-18	11/16	5
G60050-0008	8FFN	7334-40425	1/2	3/4-16	7/8	5
G60050-0010	10FFN	7334-40525	5/8	7/8-14	1	1
G60050-0012	12FFN	7334-40535	3/4	1 1/16-12	1 1/4	1
G60050-0016	16FFN	7334-40545	1	1 5/16-12	1 1/2	1

### Female Flareless Sleeve

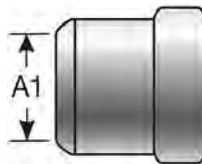

Part No.	Descr.	Prod. No.	A1	Standard Pack
			"	
G60051-0004	4FFS	7334-40555	1/4	5
G60051-0005	5FFS	7334-40565	5/16	5
G60051-0006	6FFS	7334-40575	3/8	5
G60051-0008	8FFS	7334-40435	1/2	5
G60051-0010	10FFS	7334-40585	5/8	1
G60051-0012	12FFS	7334-40595	3/4	1
G60051-0016	16FFS	7334-40605	1	1

### Tube Sleeve

For use up to SAE 100R2 maximum working pressure.

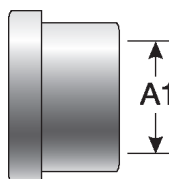

Part No.	Descr.	Prod. No.	A1	Standard Pack
			"	
G60394-0003	3TS	7259-78275	3/16	5

- EQUIPMENT
- HOSE/CPLG. SELECTION
- G8K COUPLINGS
- GLOBALSPIRAL COUPLINGS
- STAINLESS STEEL SPIRAL
- MEGACRIMP COUPLINGS
- STAINLESS STEEL BRAID
- POWER CRIMP COUPLINGS
- FIELD ATTACHABLE G1 & G2 COUPLINGS
- FIELD ATTACHABLE C5 COUPLINGS
- C14 COUPLINGS
- GL COUPLINGS
- GLX COUPLINGS
- PCTS THERMOPLASTIC COUPLINGS
- POLARSEAL COUPLINGS (ACA)
- POLARSEAL II COUPLINGS (ACC)
- POLARSEAL II COUPLINGS (ACB)
- POWER STEERING
- ADAPTERS
- QUICK DISCONNECT COUPLERS
- BALL VALVES
- LIVE SWIVEL
- ASSEMBLY FABRICATION
- ACCESSORIES
- EQUIPMENT AND PARTS
- KITS
- AIR BRAKE HOSE ASSY
- BRASS



EQUIPMENT
HOSE/CPLG. SELECTION
G8K COUPLINGS
GLOBAL SPIRAL COUPLINGS
STAINLESS STEEL SPIRAL
MEGACRIMP COUPLINGS
STAINLESS STEEL BRAID
POWER CRIMP COUPLINGS
FIELD ATTACHABLE G1 & G2 COUPLINGS
FIELD ATTACHABLE C5 COUPLINGS
C14 COUPLINGS
GL COUPLINGS
GLX COUPLINGS
PCTS THERMOPLASTIC COUPLINGS
POLARSEAL COUPLINGS (ACA)
POLARSEAL II COUPLINGS (ACC)
POLARSEAL II COUPLINGS (ACB)
POWER STEERING
ADAPTERS
QUICK DISCONNECT COUPLERS
BALL VALVES
LIVE SWIVEL
ASSEMBLY FABRICATION
ACCESSORIES
EQUIPMENT AND PARTS
KITS
AIR BRAKE HOSE ASSY
BRASS

### Tube Sleeve - Continued

Part No.	Descr.	Prod. No.	A1	Standard Pack
			"	
G60394-0004	4TS	7259-23905	1/4	5
G60394-0005	5TS	7259-23915	5/16	5
G60394-0006	6TS	7259-23925	3/8	5
G60394-0008	8TS	7259-23935	1/2	5
G60394-0010	10TS	7259-23945	5/8	1
G60394-0012	12TS	7259-23955	3/4	1
G60394-0014	14TS	7259-23965	7/8	1
G60394-0016	16TS	7259-23975	1	1
G60394-0020	20TS	7259-23985	1 1/4	1
G60394-0024	24TS	7259-23995	1 1/2	1
G60394-0032	32TS	7259-24005	2	1

### Tube Sleeve Nut

For use up to SAE 100R2 maximum working pressure.

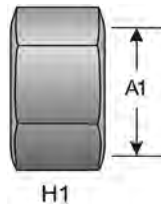

Part No.	Descr.	Prod. No.	A1		H1	Standard Pack
			"	"	"	
G60395-0002	2TSN	7259-06805	1/8	5/16-24	3/8	1
G60395-0003	3TSN	7259-78295	3/16	3/8-24	1/4	1
G60395-0004	4TSN	7259-01105	1/4	7/16-20	9/16	1
G60395-0005	5TSN	7259-01115	5/16	1/2-20	5/8	1
G60395-0006	6TSN	7259-01125	3/8	9/16-18	11/16	1
G60395-0006X	6TSN XBULK	7259-0112	3/8	9/16-18	11/16	950
G60395-0008	8TSN	7259-01135	1/2	3/4-16	7/8	1
G60395-0010	10TSN	7259-01145	5/8	7/8-14	1	1
G60395-0012	12TSN	7259-01155	3/4	1 1/16-12	1 1/4	1
G60395-0014	14TSN	7259-01165	7/8	1 3/16-12	1 3/8	1
G60395-0016	16TSN	7259-01175	1	1 5/16-12	1 1/2	1
G60395-0020	20TSN	7259-01185	1 1/4	1 5/8-12	2	1
G60395-0032	32TSN	7259-09055	2	2 1/2-12	2 7/8	1



## Locknuts for Bulkhead Fittings

For use up to SAE 100R2 maximum working pressure.



H1

Part No.	Descr.	Prod. No.		H1	Standard Pack
			"	"	
G60399-0004	4LN-SH	7259-24605	7/16-20	11/16	5
G60399-0005	5LN	7253-24615	1/2-20	3/4	5
G60399-0006	6LN-SH	7259-24625	9/16-18	11/16	5
G60399-0008	8LN-SH	7259-24635	3/4-16	1	5
G60399-0010	10LN-SH	7259-24645	7/8-14	1 1/8	1
G60399-0016	16LN-SH	7259-24665	1 5/16-12	1 5/8	1

## SAE Tubing Sleeve Nut

For use up to SAE 100R2 maximum working pressure.



Part No.	Descr.	Prod. No.			Standard Pack
			"	"	
G60685-0004	4STSN	7250-18195	1/4	7/16-20	1
G60685-0005	5STSN	7250-18205	5/16	1/2-20	1
G60685-0006	6STSN	7250-18215	3/8	5/8-18	1
G60685-0008	8STSN	7250-18225	1/2	3/4-16	1
G60685-0010	10STSN	7250-18235	5/8	7/8-14	1
G60685-0012	12STSN	7250-18245	3/4	1 1/16-14	1

WARNING: Cancer and Reproductive Harm - www.P65Warnings.ca.gov

## Metric Bite Sleeve

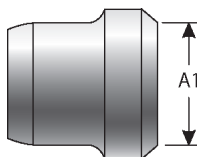

Part No.	Descr.	Prod. No.	A1	Standard Pack
			mm	
G64787-0006	6BS	7253-26815	6.0	5
G64787-0008	8BS	7253-26835	8.0	5

EQUIPMENT
HOSE/CPLG. SELECTION
G8K COUPLINGS
GLOBALSPIRAL COUPLINGS
STAINLESS STEEL SPIRAL
MEGACRIMP COUPLINGS
STAINLESS STEEL BRAID
POWER CRIMP COUPLINGS
FIELD ATTACHABLE G1 & G2 COUPLINGS
FIELD ATTACHABLE C5 COUPLINGS
C14 COUPLINGS
GL COUPLINGS
GLX COUPLINGS
PCTS THERMOPLASTIC COUPLINGS
POLARSEAL COUPLINGS (ACA)
POLARSEAL II COUPLINGS (ACC)
POLARSEAL II COUPLINGS (ACB)
POWER STEERING
ADAPTERS
QUICK DISCONNECT COUPLERS
BALL VALVES
LIVE SWIVEL
ASSEMBLY FABRICATION
ACCESSORIES
EQUIPMENT AND PARTS
KITS
AIR BRAKE HOSE ASSY
BRASS





Metric Bite Sleeve - Continued

EQUIPMENT
HOSE/CPLG. SELECTION
G8K COUPLINGS
GLOBAL SPIRAL COUPLINGS
STAINLESS STEEL SPIRAL
MEGACRIMP COUPLINGS
STAINLESS STEEL BRAID
POWER CRIMP COUPLINGS
FIELD ATTACHABLE G1 & G2 COUPLINGS
FIELD ATTACHABLE C5 COUPLINGS
C14 COUPLINGS
GL COUPLINGS
GLX COUPLINGS
PCTS THERMOPLASTIC COUPLINGS
POLARSEAL COUPLINGS (ACA)
POLARSEAL II COUPLINGS (ACC)
POLARSEAL II COUPLINGS (ACB)
POWER STEERING
ADAPTERS
QUICK DISCONNECT COUPLERS
BALL VALVES
LIVE SWIVEL
ASSEMBLY FABRICATION
ACCESSORIES
EQUIPMENT AND PARTS
KITS
AIR BRAKE HOSE ASSY
BRASS

Part No.	Descr.	Prod. No.	A1	Standard Pack
			mm	
G64787-0010	10BS	7253-26855	10.0	1
G64787-0012	12BS	7253-26875	12.0	1
G64787-0014	14BS	7253-26895	14.0	1
G64787-0015	15BS	7253-26905	15.0	1
G64787-0016	16BS	7253-26915	16.0	1
G64787-0018	18BS	7253-26925	18.0	1
G64787-0020	20BS	7253-26935	20.0	1
G64787-0022	22BS	7253-26945	22.0	1
G64787-0025	25BS	7253-26955	25.0	1
G64787-0028	28BS	7253-26965	28.0	1
G64787-0030	30BS	7253-26975	30.0	1
G64787-0035	35BS	7253-26985	35.0	1
G64787-0038	38BS	7253-26995	38.0	1
G64787-0042	42BS	7253-27005	42.0	1

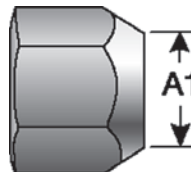
Metric Bite Nut



Part No.	Descr.	Prod. No.		A1	Standard Pack
			"	mm	
G64788-0006	6MNL	7253-27105	M12X1.5	6.0	5
G64788-06LL	6MNLL	7314-06455	M10X1.5	6.0	1
G64788-0008	8MNL	7253-27125	M14X1.5	8.0	5
G64788-0010	10MNL	7253-27145	M16X1.5	10.0	1
G64788-0012	12MNL	7253-27165	M18X1.5	12.0	1
G64788-0015	15MNL	7253-27185	M22X1.5	15.0	1
G64788-0018	18MNL	7253-27215	M26X1.5	18.0	1
G64788-0022	22MNL	7253-27235	M30X2.0	22.0	1
G64788-0028	28MNL	7253-27255	M36X2.0	28.0	1
G64788-0035	35MNL	7253-27275	M45X2.0	35.0	1
G64788-0042	42MNL	7253-27295	M52X2.0	42.0	1
G64789-0006	6MNH	7253-27115	M14X1.5	6.0	5
G64789-0008	8MNH	7253-27135	M16X1.5	8.0	5
G64789-0010	10MNH	7253-27155	M18X1.5	10.0	1
G64789-0012	12MNH	7253-27175	M20X1.5	12.0	1
G64789-0014	14MNH	7253-27195	M22X1.5	14.0	1
G64789-0016	16MNH	7253-27205	M24X1.5	16.0	1
G64789-0020	20MNH	7253-27225	M30X2.0	20.0	1
G64789-0025	25MNH	7253-27245	M36X2.0	25.0	1
G64789-0030	30MNH	7253-27265	M42X2.0	30.0	1
G64789-0038	38MNH	7253-27285	M52X2.0	38.0	1



## Diagnostic Equipment

Part No.	Descr.	Prod. No.	Standard Pack
	RFID BAND TAG - ORANGE	7485-2110	400
	RFID KEY TAG - ORANGE	7485-2120	70
	RFID LANYARD TAG 12 IN ORANGE	7485-2130	70
	RFID LANYARD TAG 24 IN ORANGE	7485-2140	200
	RFID LANYARD TAG 36 IN ORANGE	7485-2150	70

EQUIPMENT
HOSE/CPLG. SELECTION
G8K COUPLINGS
GLOBALSPIRAL COUPLINGS
STAINLESS STEEL SPIRAL
MEGACRIMP COUPLINGS
STAINLESS STEEL BRAID
POWER CRIMP COUPLINGS
FIELD ATTACHABLE G1 & G2 COUPLINGS
FIELD ATTACHABLE C5 COUPLINGS
C14 COUPLINGS
GL COUPLINGS
GLX COUPLINGS
PCTS THERMOPLASTIC COUPLINGS
POLARSEAL COUPLINGS (ACA)
POLARSEAL II COUPLINGS (ACC)
POLARSEAL II COUPLINGS (ACB)
POWER STEERING
ADAPTERS
QUICK DISCONNECT COUPLERS
BALL VALVES
LIVE SWIVEL
ASSEMBLY FABRICATION
<b>ACCESSORIES</b>
EQUIPMENT AND PARTS
KITS
AIR BRAKE HOSE ASSY
BRASS



**NOTES**

EQUIPMENT
HOSE/CPLG. SELECTION
G8K COUPLINGS
GLOBAL SPIRAL COUPLINGS
STAINLESS STEEL SPIRAL
MEGACRIMP COUPLINGS
STAINLESS STEEL BRAID
POWER CRIMP COUPLINGS
FIELD ATTACHABLE G1 & G2 COUPLINGS
FIELD ATTACHABLE C5 COUPLINGS
C14 COUPLINGS
GL COUPLINGS
GLX COUPLINGS
PCTS THERMOPLASTIC COUPLINGS
POLARSEAL COUPLINGS (ACA)
POLARSEAL II COUPLINGS (ACC)
POLARSEAL II COUPLINGS (ACB)
POWER STEERING
ADAPTERS
QUICK DISCONNECT COUPLERS
BALL VALVES
LIVE SWIVEL
ASSEMBLY FABRICATION
<b>ACCESSORIES</b>
EQUIPMENT AND PARTS
KITS
AIR BRAKE HOSE ASSY
BRASS





## Gates GC® 16XD™ Parts

Part No.	Prod. No.	Descr.	Standard Pack
78775	7482-7301	GC16XD Handle Assembly	1
78778	7482-7302	GC16XD Foam Filler	1
78779	7482-7303	GC16XD Die Tub	1
78759	7482-7304	QC Tool (QCT) GC16-XD	1
78781	7482-7305	GC16XD End Caps	1
78782	7482-7306	GC16XD Stand Off Assembly (Long Version)	1
78795	7482-7307	GC16XD Die Retainer Sets	1
78796	7482-7308	GC16XD Dial Vernier Assembly	1
78797	7482-7309	GC16XD Bracket Assembly	1
78733	7482-7313	GC16XD Start Up Kit	1

## MobileCrimp® 4-20 Positive Stop Spacers

Part No.	Prod. No.	Descr.	Standard Pack
78481	7482-1102	B1 Spacer, PS	1
78482	7482-1103	W1 Spacer, PS	1
78483	7482-1104	R1 Spacer, PS	1
78484	7482-1105	B2 Spacer, PS	1
78485	7482-1106	W2 Spacer, PS	1
78486	7482-1107	R2 Spacer, PS	1
78487	7482-1108	B3 Spacer, PS	1
78488	7482-1109	W3 Spacer, PS	1
78489	7482-1110	R3 Spacer, PS	1
78490	7482-1111	B4 Spacer, PS	1
78491	7482-1112	W4 Spacer, PS	1
78492	7482-1113	R4 Spacer, PS	1
78493	7482-1114	B5 Spacer, PS	1
78494	7482-1115	W5 Spacer, PS	1
78495	7482-1116	R5 Spacer, PS	1

## MobileCrimp® 4-20 Parts



Part No.	Prod. No.	Descr.	Standard Pack
78450	7482-1000	Magnet for Handling Die Sets	1
78455	7482-1005	Stand	1
78456	7482-1006	Pivot Spacer	1

EQUIPMENT
HOSE/CPLG. SELECTION
G8K COUPLINGS
GLOBALSPIRAL COUPLINGS
STAINLESS STEEL SPIRAL
MEGACRIMP COUPLINGS
STAINLESS STEEL BRAID
POWER CRIMP COUPLINGS
FIELD ATTACHABLE G1 & G2 COUPLINGS
FIELD ATTACHABLE C5 COUPLINGS
C14 COUPLINGS
GL COUPLINGS
GLX COUPLINGS
PCTS THERMOPLASTIC COUPLINGS
POLARSEAL COUPLINGS (ACA)
POLARSEAL II COUPLINGS (ACC)
POLARSEAL II COUPLINGS (ACB)
POWER STEERING
ADAPTERS
QUICK DISCONNECT COUPLERS
BALL VALVES
LIVE SWIVEL
ASSEMBLY FABRICATION
ACCESSORIES
EQUIPMENT AND PARTS
KITS
AIR BRAKE HOSE ASSY
BRASS



## MobileCrimp® 4-20 Parts - Continued

EQUIPMENT
HOSE/CPLG. SELECTION
G8K COUPLINGS
GLOBAL SPIRAL COUPLINGS
STAINLESS STEEL SPIRAL
MEGACRIMP COUPLINGS
STAINLESS STEEL BRAID
POWER CRIMP COUPLINGS
FIELD ATTACHABLE G1 & G2 COUPLINGS
FIELD ATTACHABLE C5 COUPLINGS
C14 COUPLINGS
GL COUPLINGS
GLX COUPLINGS
PCTS THERMOPLASTIC COUPLINGS
POLARSEAL COUPLINGS (ACA)
POLARSEAL II COUPLINGS (ACC)
POLARSEAL II COUPLINGS (ACB)
POWER STEERING
ADAPTERS
QUICK DISCONNECT COUPLERS
BALL VALVES
LIVE SWIVEL
ASSEMBLY FABRICATION
ACCESSORIES
EQUIPMENT AND PARTS
KITS
AIR BRAKE HOSE ASSY
BRASS

Part No.	Prod. No.	Descr.	Standard Pack
78459	7482-1009	Stand Clamp	1
78462	7482-1012	Pivot Knob	1
78463	7482-1013	Positive Stop Pressure Plate	1
78465	7482-1015	DD Computer Pressure Plate	1
78467	7482-1017	Hose Assembly	125
78437	7482-1036	Pusher	1
78438	7482-1037	Cover Plate	1
78440	7482-1041	Seal Kit Includes: Seal, Washer and Backup Ring	1
78046	7482-1078	DD Pressure Plate for 20G/MC38	1
78445	7482-1098	Computer Cable	1
78447	7482-1100	Digital Dial Assy. Kit (To Upgrade PS)	1
78449	7482-1117	Ball Plunger for Top of Cylinder	1
78427	7482-1147	Die Spring	1
78426	7482-1148	Die Link	1
78428	7482-1149	Shoulder Screws	1
78419	7482-1157	Slydring for Piston	1
78420	7482-1163	Tall Handle for DD	1
78421	7482-1164	Locking Pin	1
78422	7482-1165	Chain for Locking Pin	1
78424	7482-1168	Cable Assy. for DD	1
78396	7482-1170	DD Top Mt Contrl Kit (side to top mount)	1
78397	7482-1171	DD Controller Top Mount	1
78425	7482-1190	Retaining Ring for Piston	1

## Power Crimp® 707 Parts



Part No.	Prod. No.	Descr.	Standard Pack
78251	7480-6591	PC703 to PC707 Conversion Kit	1
78717	7482-0054	Crimp Switch Button for PC603/PC707	1
78718	7482-0105	Piston New Design (Seals Included)	1
78719	7482-0106	Piston Rod	1
78722	7482-0109	Piston Rod Guide	1
78723	7482-0110	Base Plate (Machine)	1
78724	7482-0111	Tie Rod	1
78725	7482-0112	Pusher Cup (update design)	1
78728	7482-0116	Cylinder and Top Plate	1
78729	7482-0118	Spring Anchor	1
78730	7482-0119	Mounting Bracket	1
78732	7482-0147	O-Ring Between Piston and Rod	1
78734	7482-0229	Actuator Rod	1



### Power Crimp® 707 Parts - Continued

Part No.	Prod. No.	Descr.	Standard Pack
78736	7482-0239	Die Cone With Notch	1
78737	7482-0243	Tie Rod Nut	1
78739	7482-0277	Switch Box Complete w/115V Cord Assy.	1
78740	7482-0280	Digital Readout Meter	1
78742	7482-0283	PC707 Shroud Only	1
78745	7482-0289	PC707 Hose Assy. (Pump to Crimper)	115
78746	7482-0291	Magnet for Removing Dies	1
78747	7482-0297	Die Cone (No Notch)	1
78252	7482-0442	Microswitch	1
78748	7482-0498	230V Cord Assy. for Digital Readout	1
78760	7482-0499	PC707 230V Converter Kit	1
78754	7482-0747	115V Cord Assy for Digital Readout	1
78478	7482-0789	Die Cage Halves (Set of 2) for 700 Series	1
78758	7482-0919	Stainless Steel Washer	1
78940	7482-0940	Die Cage Halves for 739	1
78757	7482-1095	PC707 Seal Kit for New Aluminum Piston Serial Nos. 14,000 and Up	1
78750	7482-1215	Silver Die Back Up Ring	1
78761	7482-1422	LifeGuard Plate	1
78762	7482-1423	LifeGuard Plate and Die Kit	1
78749	7482-1672	Screw for Die Fingers	1
78755	7482-3011	Molykote 3 oz. Jar G Die Lubricant	1
78751	7482-6959	Piston Return Spring for PC707/3000B	1

### GC® 32 Parts



Part No.	Prod. No.	Descr.	Standard Pack
78832	7482-7100	Head Replacement Kit	1
78833	7482-7101	Panel Replacement Kit	1
78834	7482-7102	Valve Block Adapters	1
78835	7482-7103	Pilot Operated Check	1
78836	7482-7104	Quick Change Tool	1
78837	7482-7105	Dial Vernier	1
78840	7482-7108	Depth Stop	1
78841	7482-7109	Mirror	1
78843	7482-7111	Foot Pedal	1
78847	7482-7115	Control Panel Post	1
78848	7482-7116	Kicker Tubing (Upper)	1
78849	7482-7117	Kicker Tubing (Lower)	1
78851	7482-7119	Foam Fillers GC32-XD Set of 8	8

- EQUIPMENT
- HOSE/CPLG. SELECTION
- G8K COUPLINGS
- GLOBALSPIRAL COUPLINGS
- STAINLESS STEEL SPIRAL
- MEGACRIMP COUPLINGS
- STAINLESS STEEL BRAID
- POWER CRIMP COUPLINGS
- FIELD ATTACHABLE G1 & G2 COUPLINGS
- FIELD ATTACHABLE C5 COUPLINGS
- C14 COUPLINGS
- GL COUPLINGS
- GLX COUPLINGS
- PCTS THERMOPLASTIC COUPLINGS
- POLARSEAL COUPLINGS (ACA)
- POLARSEAL II COUPLINGS (ACC)
- POLARSEAL II COUPLINGS (ACB)
- POWER STEERING
- ADAPTERS
- QUICK DISCONNECT COUPLERS
- BALL VALVES
- LIVE SWIVEL
- ASSEMBLY FABRICATION
- ACCESSORIES
- EQUIPMENT AND PARTS**
- KITS
- AIR BRAKE HOSE ASSY
- BRASS

GC<sup>®</sup> 32 Parts - Continued

EQUIPMENT
HOSE/CPLG. SELECTION
G8K COUPLINGS
GLOBAL SPIRAL COUPLINGS
STAINLESS STEEL SPIRAL
MEGACRIMP COUPLINGS
STAINLESS STEEL BRAID
POWER CRIMP COUPLINGS
FIELD ATTACHABLE G1 & G2 COUPLINGS
FIELD ATTACHABLE C5 COUPLINGS
C14 COUPLINGS
GL COUPLINGS
GLX COUPLINGS
PCTS THERMOPLASTIC COUPLINGS
POLARSEAL COUPLINGS (ACA)
POLARSEAL II COUPLINGS (ACC)
POLARSEAL II COUPLINGS (ACB)
POWER STEERING
ADAPTERS
QUICK DISCONNECT COUPLERS
BALL VALVES
LIVE SWIVEL
ASSEMBLY FABRICATION
ACCESSORIES
EQUIPMENT AND PARTS
KITS
AIR BRAKE HOSE ASSY
BRASS

Part No.	Prod. No.	Descr.	Standard Pack
78856	7482-7124	Die Tubs	1
78858	7482-7126	Head Seal	1
78907	7482-7175	Breather Cap	1
78909	7482-7179	Kicker	1
78910	7482-7180	2 Position 3-Way Solenoid	1
78918	7482-7188	Dial Vernier Locking Plate	1
78924	7482-7193	Relief Valve	1
78925	7482-7194	Back Press. Cont. Cartridge	1
78927	7482-7196	Oil Filter Element	1
74827208	7482-7208	Control Box CSA	1
74827227	7482-7227	Surge Protector w/Hubbell Plug	144
79006	7482-7246	OTC Repair Kit GC32/96 series up to 2"	1
78047	7482-7247	GC96TS, TSi, GC32TSi Power Supply	4
78048	7482-7248	GC96 GC32XD Transformer	4
74827267	7482-7267	GC32 Inverter	1
78002	7482-7268	Die Retention Plate Kit	1

Gates GC<sup>®</sup> 96 Parts

Part No.	Prod. No.	Descr.	Standard Pack
74829100	7482-9100	GC96TS Control Box with Potentiometer	1
74829181	7482-9181	GC96TS Die Release Tool	1



Stop searching and start saving with these great hydraulic assortments. For once, all your hydraulic components will be in one place. And they are organized by size and style.

### O-Ring (OR, FLOR, ORFF) Assortment Kit

**Part Number:** 85001  
**Product Number:** 7369-0001



O-Rings for Straight-Thread Boss Fittings		
Descr.	Part No.	Quantity
4 O-RING	G60248-0004	10
6 O-RING	G60248-0006	10
8 O-RING	G60248-0008	10
10 O-RING	G60248-0010	10
12 O-RING	G60248-0012	10
16 O-RING	G60248-0016	10
20 O-RING	G60248-0020	10

O-Rings for Code 61 & 62 Flange Fittings		
Descr.	Part No.	Quantity
12 FLANGE O-RING	G60898-0012	10
16 FLANGE O-RING	G60898-0016	10
20 FLANGE O-RING	G60898-0020	10

O-Rings for Flat-Face Fittings		
Descr.	Part No.	Quantity
4 O-RING FF	G60698-0004	10
6 O-RING FF	G60698-0006	10
8 O-RING FF	G60698-0008	10
10 O-RING FF	G60698-0010	10
12 O-RING FF	G60698-0012	10
14 O-RING FF	G60698-0016	10

### Flat-Face Plug (MFFOR) and Cap (FFOR) Kit

**Part Number:** 85002  
**Product Number:** 7369-0002



Flat-Face O-Ring Caps		
Descr.	Part No.	Quantity
4FFOR-CAP	G60701-0004	2
6FFOR-CAP	G60701-0006	2
8FFOR-CAP	G60701-0008	2
10FFOR-CAP	G60701-0010	2
12FFOR-CAP	G60701-0012	2
16FFOR-CAP	G60701-0016	2

Flat-Face O-Ring Plugs		
Descr.	Part No.	Quantity
4MFFOR-PLUG	G60702-0004	2
6MFFOR-PLUG	G60702-0006	2
8MFFOR-PLUG	G60702-0008	2
10MFFOR-PLUG	G60702-0010	2
12MFFOR-PLUG	G60702-0012	2
16MFFOR-PLUG	G60702-0016	2

- EQUIPMENT
- HOSE/CPLG. SELECTION
- G8K COUPLINGS
- GLOBALSPIRAL COUPLINGS
- STAINLESS STEEL SPIRAL
- MEGACRIMP COUPLINGS
- STAINLESS STEEL BRAID
- POWER CRIMP COUPLINGS
- FIELD ATTACHABLE G1 & G2 COUPLINGS
- FIELD ATTACHABLE C5 COUPLINGS
- C14 COUPLINGS
- GL COUPLINGS
- GLX COUPLINGS
- PCTS THERMOPLASTIC COUPLINGS
- POLARSEAL COUPLINGS (ACA)
- POLARSEAL II COUPLINGS (ACC)
- POLARSEAL II COUPLINGS (ACB)
- POWER STEERING
- ADAPTERS
- QUICK DISCONNECT COUPLERS
- BALL VALVES
- LIVE SWIVEL
- ASSEMBLY FABRICATION
- ACCESSORIES
- EQUIPMENT AND PARTS
- KITS**
- AIR BRAKE HOSE ASSY
- BRASS



EQUIPMENT
HOSE/CPLG. SELECTION
G8K COUPLINGS
GLOBAL SPIRAL COUPLINGS
STAINLESS STEEL SPIRAL
MEGACRIMP COUPLINGS
STAINLESS STEEL BRAID
POWER CRIMP COUPLINGS
FIELD ATTACHABLE G1 & G2 COUPLINGS
FIELD ATTACHABLE C5 COUPLINGS
C14 COUPLINGS
GL COUPLINGS
GLX COUPLINGS
PCTS THERMOPLASTIC COUPLINGS
POLARSEAL COUPLINGS (ACA)
POLARSEAL II COUPLINGS (ACC)
POLARSEAL II COUPLINGS (ACB)
POWER STEERING
ADAPTERS
QUICK DISCONNECT COUPLERS
BALL VALVES
LIVE SWIVEL
ASSEMBLY FABRICATION
ACCESSORIES
EQUIPMENT AND PARTS
<b>KITS</b>
AIR BRAKE HOSE ASSY
BRASS

## JIC Plug (MJ) and Cap (FJ) Kit

**Part Number:** 85003  
**Product Number:** 7369-0003



Male 37° Flare (JIC) Plug		
Descr.	Part No.	Quantity
4MJ-PLUG	G60402-0004	2
5MJ-PLUG	G60402-0005	2
6MJ-PLUG	G60402-0006	2
8MJ-PLUG	G60402-0008	2
10MJ-PLUG	G60402-0010	2
12MJ-PLUG	G60402-0012	2
14MJ-PLUG	G60402-0014	2
16MJ-PLUG	G60402-0016	2
20MJ-PLUG	G60402-0020	2

Female 37° Flare (JIC) Cap		
Descr.	Part No.	Quantity
4FJ-CAP	G60401-0004	2
5FJ-CAP	G60401-0005	2
6FJ-CAP	G60401-0006	2
8FJ-CAP	G60401-0008	2
10FJ-CAP	G60401-0010	2
12FJ-CAP	G60401-0012	2
16FJ-CAP	G60401-0016	2
20FJ-CAP	G60401-0020	2

## Male Pipe (MP) and O-Ring Boss (MB) Plug Kit

**Part Number:** 85004  
**Product Number:** 7369-0004



\*Space for plugs, but not included in kit.

Male Pipe Plug		
Descr.	Part No.	Quantity
2MP-PLUG	G60102-0002	2
4MP-PLUG	G60102-0004	2
6MP-PLUG	G60102-0006	2
8MP-PLUG	G60102-0008	2
12MP-PLUG	G60102-0012	2
16MP-PLUG	G60102-0016	2
20MP-PLUG	G60102-0020	2
24MP-PLUG	G60102-0024	Optional*

Male O-Ring Boss Plug		
Descr.	Part No.	Quantity
4MB-PLUG	G60250-0004	2
5MB-PLUG	G60250-0005	2
6MB-PLUG	G60250-0006	2
8MB-PLUG	G60250-0008	2
10MB-PLUG	G60250-0010	2
12MB-PLUG	G60250-0012	2
16MB-PLUG	G60250-0016	1



## Rubber Air Brake & C14 Assembly Assortments

**Assortment Part Number:** 91181, **Assortment Product Number:** 7626-0105

Part No.	Descr.	Length	Unit Count
G89170-1036	10C14-10FJSX-10FJSX-36	36"	1
G89170-1048	10C14-10FJSX-10FJSX-48	48"	1
G89170-1054	10C14-10FJSX-10FJSX-54	54"	1
G89170-1084	10C14-10FJSX-10FJSX-84	84"	1
27245	3/8" Hose, 6AB-4MP-6MPA-20	20"	1
27246	3/8" Hose, 6AB-4MP-6MPA-24	24"	1
27248	3/8" Hose, 6AB-4MP-6MPA-30	30"	1
27252	1/2" Hose, 8AB-6MP-6MPA-18	18"	1
27253	1/2" Hose, 8AB-6MP-6MPA-20	20"	1
27254	1/2" Hose, 8AB-6MP-6MPA-24	24"	2
27255	1/2" Hose, 8AB-6MP-6MPA-28	28"	2
27256	1/2" Hose, 8AB-6MP-6MPA-30	30"	2
27257	1/2" Hose, 8AB-6MP-6MPA-32	32"	1
27258	1/2" Hose, 8AB-6MP-6MPA-36	36"	2
27259	1/2" Hose, 8AB-6MP-6MPA-42	42"	2
27266	3/8" Hose, 6AB-6MP-6MPA-24	24"	2
27267	3/8" Hose, 6AB-6MP-6MPA-26	26"	1
27268	3/8" Hose, 6AB-6MP-6MPA-28	28"	2
27269	3/8" Hose, 6AB-6MP-6MPA-30	30"	1
27270	3/8" Hose, 6AB-6MP-6MPA-32	32"	1
27272	3/8" Hose, 6AB-6MP-6MPA-36	36"	1
27275	3/8" Hose, 6AB-6MP-6MPA-42	42"	1
27279	3/8" Hose, 6AB-6MP-6MPA-48	48"	1
27281	3/8" Hose, 6AB-6MP-6MPA-60	60"	1
91180	Air Brake Hose Rack	—	2
—	Content Sheet	—	1
—	Part No. Decals	—	24



**Assortment Part Number:** 91182, **Assortment Product Number:** 7626-0104

Part No.	Descr.	Length	Unit Count
G89170-1048	10C14-10FJSX-10FJSX-48	48"	1
G89170-1054	10C14-10FJSX-10FJSX-54	54"	1
27246	3/8" Hose, 6AB-4MP-6MPA-24	24"	1
27254	1/2" Hose, 8AB-6MP-6MPA-24	24"	2
27255	1/2" Hose, 8AB-6MP-6MPA-28	28"	1
27256	1/2" Hose, 8AB-6MP-6MPA-30	30"	2
27258	1/2" Hose, 8AB-6MP-6MPA-36	36"	2
27259	1/2" Hose, 8AB-6MP-6MPA-42	42"	1
27266	3/8" Hose, 6AB-6MP-6MPA-24	24"	2
27268	3/8" Hose, 6AB-6MP-6MPA-28	28"	1
27269	3/8" Hose, 6AB-6MP-6MPA-30	30"	1
27272	3/8" Hose, 6AB-6MP-6MPA-36	36"	1
91180	Air Brake Hose Rack	—	1
—	Content Sheet	—	1
—	Part No. Decals	—	12

EQUIPMENT
HOSE/CPLG. SELECTION
G8K COUPLINGS
GLOBALSPIRAL COUPLINGS
STAINLESS STEEL SPIRAL
MEGACRIMP COUPLINGS
STAINLESS STEEL BRAID
POWER CRIMP COUPLINGS
FIELD ATTACHABLE G1 & G2 COUPLINGS
FIELD ATTACHABLE C5 COUPLINGS
C14 COUPLINGS
GL COUPLINGS
GLX COUPLINGS
PCTS THERMOPLASTIC COUPLINGS
POLARSEAL COUPLINGS (ACA)
POLARSEAL II COUPLINGS (ACC)
POLARSEAL II COUPLINGS (ACB)
POWER STEERING
ADAPTERS
QUICK DISCONNECT COUPLERS
BALL VALVES
LIVE SWIVEL
ASSEMBLY FABRICATION
ACCESSORIES
EQUIPMENT AND PARTS
<b>KITS</b>
AIR BRAKE HOSE ASSY
BRASS





EQUIPMENT
HOSE/CPLG. SELECTION
G8K COUPLINGS
GLOBAL SPIRAL COUPLINGS
STAINLESS STEEL SPIRAL
MEGACRIMP COUPLINGS
STAINLESS STEEL BRAID
POWER CRIMP COUPLINGS
FIELD ATTACHABLE G1 & G2 COUPLINGS
FIELD ATTACHABLE C5 COUPLINGS
C14 COUPLINGS
GL COUPLINGS
GLX COUPLINGS
PCTS THERMOPLASTIC COUPLINGS
POLARSEAL COUPLINGS (ACA)
POLARSEAL II COUPLINGS (ACC)
POLARSEAL II COUPLINGS (ACB)
POWER STEERING
ADAPTERS
QUICK DISCONNECT COUPLERS
BALL VALVES
LIVE SWIVEL
ASSEMBLY FABRICATION
ACCESSORIES
EQUIPMENT AND PARTS
<b>KITS</b>
AIR BRAKE HOSE ASSY
BRASS



### Bonded Seals

**Part Number:** 85041  
**Product Number:** 7369-5041

Descr.	Part No.	Quantity
2BBDS	G64075-0002	Optional*
4BBDS	G64075-0004	10
6BBDS	G64075-0006	10
8BBDS	G64075-0008	10
10BBDS	G64075-0010	10
12BBDS	G64075-0012	10
16BBDS	G64075-0016	10
20BBDS	G64075-0020	Optional*
24BBDS	G64075-0024	Optional*
32BBDS	G64075-0032	Optional*
6MBDS	G64775-0006	10
8MBDS	G64775-0008	10
10MBDS	G64775-0010	10
12MBDS	G64775-0012	10
14MBDS	G64775-0014	10
16MBDS	G64775-0016	10
18MBDS	G64775-0018	10
20MBDS	G64775-0020	10
22MBDS	G64775-0022	10
24MBDS	G64775-0024	Optional*
26MBDS	G64775-0026	Optional*
27MBDS	G64775-0027	Optional*
30MBDS	G64775-0030	Optional*
33MBDS	G64775-0033	Optional*
36MBDS	G64775-0036	Optional*
42MBDS	G64775-0042	Optional*

\*Space for bonded seals, but not included in kit.



### British

**Part Number:** 85042  
**Product Number:** 7369-5042

Descr.	Part No.	Quantity
2MBSFOR-PLUG	G64094-0002	2
4MBSFOR-PLUG	G64094-0004	2
6MBSFOR-PLUG	G64094-0006	2
8MBSFOR-PLUG	G64094-0008	2
12MBSFOR-PLUG	G64094-0012	Optional*
16MBSFOR-PLUG	G64094-0016	Optional*
20MBSFOR-PLUG	G64094-0020	Optional*
2MBSPP-PLUG	G64099-0002	2
4MBSPP-PLUG	G64099-0004	2
6MBSPP-PLUG	G64099-0006	2
8MBSPP-PLUG	G64099-0008	2
10MBSPP-PLUG	G64099-0010	2
12MBSPP-PLUG	G64099-0012	2
16MBSPP-PLUG	G64099-0016	Optional*
20MBSPP-PLUG	G64099-0020	Optional*
24MBSPP-PLUG	G64099-0024	Optional*
32MBSPP-PLUG	G64099-0032	Optional*
2MBSPT-PLUG	G64098-0002	2
4MBSPT-PLUG	G64098-0004	2
6MBSPT-PLUG	G64098-0006	2
8MBSPT-PLUG	G64098-0008	2
10MBSPT-PLUG	G64098-0010	2
12MBSPT-PLUG	G64098-0012	2
16MBSPT-PLUG	G64098-0016	Optional*
20MBSPT-PLUG	G64098-0020	Optional*
24MBSPT-PLUG	G64098-0024	Optional*
32MBSPT-PLUG	G64098-0032	Optional*
2FBSPP-CAP	G64097-0002	2
4FBSPP-CAP	G64097-0004	2
6FBSPP-CAP	G64097-0006	2
8FBSPP-CAP	G64097-0008	2
10FBSPP-CAP	G64097-0010	2
12FBSPP-CAP	G64097-0012	2
16FBSPP-CAP	G64097-0016	Optional*
20FBSPP-CAP	G64097-0020	Optional*
24FBSPP-CAP	G64097-0024	Optional*
32FBSPP-CAP	G64097-0032	Optional*

\*Space for plugs and caps, but not included in kit.





### DIN Light

**Part Number:** 85043

**Product Number:** 7369-5043

Descr.	Part No.	Quantity
6MDL-PLUG	G64792-0006	2
8MDL-PLUG	G64792-0008	2
10MDL-PLUG	G64792-0010	2
12MDL-PLUG	G64792-0012	2
15MDL-PLUG	G64792-0015	2
18MDL-PLUG	G64792-0018	2
22MDL-PLUG	G64792-0022	2
28MDL-PLUG	G64792-0028	Optional*
35MDL-PLUG	G64792-0035	Optional*
42MDL-PLUG	G64792-0042	Optional*
6FDL-CAP	G64793-0006	2
8FDL-CAP	G64793-0008	2
10FDL-CAP	G64793-0010	2
12FDL-CAP	G64793-0012	2
15FDL-CAP	G64793-0015	2
18FDL-CAP	G64793-0018	2
22FDL-CAP	G64793-0022	2
28FDL-CAP	G64793-0028	Optional*
35FDL-CAP	G64793-0035	Optional*
42FDL-CAP	G64793-0042	Optional*

\*Space for plugs and caps, but not included in kit.



### DIN Heavy

**Part Number:** 85044

**Product Number:** 7369-5044

Descr.	Part No.	Quantity
8MDH-PLUG	G64794-0008	2
10MDH-PLUG	G64794-0010	2
12MDH-PLUG	G64794-0012	2
14MDH-PLUG	G64794-0014	2
16MDH-PLUG	G64794-0016	2
20MDH-PLUG	G64794-0020	2
25MDH-PLUG	G64794-0025	2
30MDH-PLUG	G64794-0030	Optional*
38MDH-PLUG	G64794-0038	Optional*
8FDH-CAP	G64795-0008	2
10FDH-CAP	G64795-0010	2
12FDH-CAP	G64795-0012	2
14FDH-CAP	G64795-0014	2
16FDH-CAP	G64795-0016	2
20FDH-CAP	G64795-0020	2
25FDH-CAP	G64795-0025	2
30FDH-CAP	G64795-0030	Optional*
38FDH-CAP	G64795-0038	Optional*

\*Space for plugs and caps, but not included in kit.

EQUIPMENT
HOSE/CPLG. SELECTION
G8K COUPLINGS
GLOBALSPIRAL COUPLINGS
STAINLESS STEEL SPIRAL
MEGACRIMP COUPLINGS
STAINLESS STEEL BRAID
POWER CRIMP COUPLINGS
FIELD ATTACHABLE G1 & G2 COUPLINGS
FIELD ATTACHABLE C5 COUPLINGS
C14 COUPLINGS
GL COUPLINGS
GLX COUPLINGS
PCTS THERMOPLASTIC COUPLINGS
POLARSEAL COUPLINGS (ACA)
POLARSEAL II COUPLINGS (ACC)
POLARSEAL II COUPLINGS (ACB)
POWER STEERING
ADAPTERS
QUICK DISCONNECT COUPLERS
BALL VALVES
LIVE SWIVEL
ASSEMBLY FABRICATION
ACCESSORIES
EQUIPMENT AND PARTS
KITS
AIR BRAKE HOSE ASSY
BRASS



EQUIPMENT
HOSE/CPLG. SELECTION
G8K COUPLINGS
GLOBAL SPIRAL COUPLINGS
STAINLESS STEEL SPIRAL
MEGACRIMP COUPLINGS
STAINLESS STEEL BRAID
POWER CRIMP COUPLINGS
FIELD ATTACHABLE G1 & G2 COUPLINGS
FIELD ATTACHABLE C5 COUPLINGS
C14 COUPLINGS
GL COUPLINGS
GLX COUPLINGS
PCTS THERMOPLASTIC COUPLINGS
POLARSEAL COUPLINGS (ACA)
POLARSEAL II COUPLINGS (ACC)
POLARSEAL II COUPLINGS (ACB)
POWER STEERING
ADAPTERS
QUICK DISCONNECT COUPLERS
BALL VALVES
LIVE SWIVEL
ASSEMBLY FABRICATION
ACCESSORIES
EQUIPMENT AND PARTS
<b>KITS</b>
AIR BRAKE HOSE ASSY
BRASS



### Metric

**Part Number:** 85045  
**Product Number:** 7369-5045

Descr.	Part No.	Quantity
8MM-PLUG	G64790-0008	2
10MM-PLUG	G64790-0010	2
12MM-PLUG	G64790-0012	2
14MM-PLUG	G64790-0014	2
16MM-PLUG	G64790-0016	2
18MM-PLUG	G64790-0018	2
20MM-PLUG	G64790-0020	2
22MM-PLUG	G64790-0022	2
24MM-PLUG	G64790-0024	2
26MM-PLUG	G64790-0026	2
30MM-PLUG	G64790-0030	2
22MKB-PLUG	G63980-0022	2

### Japanese

**Part Number:** 85046  
**Product Number:** 7369-5046

Descr.	Part No.	Quantity
4FK-CAP	G65597-0004	2
6FK-CAP	G65597-0006	2
8FK-CAP	G65597-0008	2
10FK-CAP	G65597-0010	2
12FK-CAP	G65597-0012	2
16FK-CAP	G65597-0016	Optional*
4MK-PLUG	G65599-0004	2
6MK-PLUG	G65599-0006	2
8MK-PLUG	G65599-0008	2
10MK-PLUG	G65599-0010	2
12MK-PLUG	G65599-0012	2
16MK-PLUG	G65599-0016	Optional*
4FJIS-CAP	G65097-0004	2
6FJIS-CAP	G65097-0006	2
8FJIS-CAP	G65097-0008	2
12FJIS-CAP	G65097-0012	2
16FJIS-CAP	G65097-0016	2
20FJIS-CAP	G65097-0020	Optional*
24FJIS-CAP	G65097-0024	Optional*
32FJIS-CAP	G65097-0032	Optional*
4MJIS-PLUG	G65099-0004	2
6MJIS-PLUG	G65099-0006	2
8MJIS-PLUG	G65099-0008	2
12MJIS-PLUG	G65099-0012	2
16MJIS-PLUG	G65099-0016	2
20MJIS-PLUG	G65099-0020	Optional*
24MJIS-PLUG	G65099-0024	Optional*
32MJIS-PLUG	G65099-0032	Optional*

\*Space for plugs and caps, but not included in kit.



### 1/2" ID Hose with 1/2" Female SAE Swivel at Both Ends



Part No.	Descr.	Prod. No.	Length	
			"	mm
△ 27693	8AB-8FSX-8FSX-18	7745-9146	18	457.0
△ 27695	8AB-8FSX-8FSX-24	7745-9138	24	610.0
△ 27696	8AB-8FSX-8FSX-30	7745-9139	30	762.0
△ 27697	8AB-8FSX-8FSX-36	7745-9140	36	914.4
△ 27698	8AB-8FSX-8FSX-42	7745-9141	42	1067.0
△ 27699	8AB-8FSX-8FSX-48	7745-9142	48	1219.0
△ 27701	8AB-8FSX-8FSX-60	7745-9144	60	1524.0
△ 27700	AB-8FSX-8FSX-54	7745-9143	54	1372.0

△ WARNING: Cancer and Reproductive Harm - www.P65Warnings.ca.gov

### 1/2" ID Hose with 3/8" Male Pipe NPTF Swivel at Both Ends



Part No.	Descr.	Prod. No.	Length	
			"	mm
△ 27602	8AB-6MPX-6MPX-08	7745-9083	8	203.0
△ 27603	8AB-6MPX-6MPX-12	7745-9084	12	305.0
△ 27605	8AB-6MPX-6MPX-16	7745-9085	16	406.0
△ 27607	8AB-6MPX-6MPX-20	7745-9086	20	508.0
△ 27609	8AB-6MPX-6MPX-24	7745-9087	24	610.0
△ 27611	8AB-6MPX-6MPX-28	7745-9088	28	711.0
△ 27613	8AB-6MPX-6MPX-32	7745-9089	32	813.0
△ 27615	8AB-6MPX-6MPX-36	7745-9090	36	914.4
△ 27618	8AB-6MPX-6MPX-42	7745-9091	42	1067.0
△ 27621	8AB-6MPX-6MPX-48	7749-9092	48	1219.0
△ 27624	8AB-6MPX-6MPX-54	7745-9093	54	1372.0
△ 27626	8AB-6MPX-6MPX-60	7745-9094	60	1524.0
△ 27627	8AB-6MPX-6MPX-66	7745-9095	66	1676.0
△ 27628	8AB-6MPX-6MPX-72	7745-9096	72	1829.0
△ 27629	8AB-6MPX-6MPX-84	7745-9097	84	2134.0

△ WARNING: Cancer and Reproductive Harm - www.P65Warnings.ca.gov

### 3/8" ID Hose with 1/4" Male Pipe NPTF Swivel at Both Ends



Part No.	Descr.	Prod. No.	Length	
			"	mm
△ 27658	6AB-4MPX-4MPX-08	7745-9114	8	203.0
△ 27659	6AB-4MPX-4MPX-12	7745-9115	12	305.0

△ WARNING: Cancer and Reproductive Harm - www.P65Warnings.ca.gov

EQUIPMENT
HOSE/CPLG. SELECTION
G8K COUPLINGS
GLOBAL SPIRAL COUPLINGS
STAINLESS STEEL SPIRAL
MEGACRIMP COUPLINGS
STAINLESS STEEL BRAID
POWER CRIMP COUPLINGS
FIELD ATTACHABLE G1 & G2 COUPLINGS
FIELD ATTACHABLE C5 COUPLINGS
C14 COUPLINGS
GL COUPLINGS
GLX COUPLINGS
PCTS THERMOPLASTIC COUPLINGS
POLARSEAL COUPLINGS (ACA)
POLARSEAL II COUPLINGS (ACC)
POLARSEAL II COUPLINGS (ACB)
POWER STEERING
ADAPTERS
QUICK DISCONNECT COUPLERS
BALL VALVES
LIVE SWIVEL
ASSEMBLY FABRICATION
ACCESSORIES
EQUIPMENT AND PARTS
KITS
AIR BRAKE HOSE ASSY
BRASS



3/8" ID Hose with 1/4" Male Pipe NPTF Swivel at Both Ends - Continued

EQUIPMENT
HOSE/CPLG. SELECTION
G8K COUPLINGS
GLOBAL SPIRAL COUPLINGS
STAINLESS STEEL SPIRAL
MEGACRIMP COUPLINGS
STAINLESS STEEL BRAID
POWER CRIMP COUPLINGS
FIELD ATTACHABLE G1 & G2 COUPLINGS
FIELD ATTACHABLE C5 COUPLINGS
C14 COUPLINGS
GL COUPLINGS
GLX COUPLINGS
PCTS THERMOPLASTIC COUPLINGS
POLARSEAL COUPLINGS (ACA)
POLARSEAL II COUPLINGS (ACC)
POLARSEAL II COUPLINGS (ACB)
POWER STEERING
ADAPTERS
QUICK DISCONNECT COUPLERS
BALL VALVES
LIVE SWIVEL
ASSEMBLY FABRICATION
ACCESSORIES
EQUIPMENT AND PARTS
KITS
AIR BRAKE HOSE ASSY
BRASS

Part No.	Descr.	Prod. No.	Length	
			"	mm
△ 27661	6AB-4MPX-4MPX-16	7745-9116	16	406.0
△ 27663	6AB-4MPX-4MPX-20	7745-9117	20	508.0
△ 27665	6AB-4MPX-4MPX-24	7745-9118	24	610.0
△ 27667	6AB-4MPX-4MPX-28	7745-9119	28	711.0
△ 27669	6AB-4MPX-4MPX-32	7745-9120	32	813.0
△ 27671	6AB-4MPX-4MPX-36	7745-9121	36	914.4
△ 27674	6AB-4MPX-4MPX-42	7745-9122	42	1067.0
△ 27677	6AB-4MPX-4MPX-48	7745-9123	48	1219.0
△ 27679	6AB-4MPX-4MPX-52	7745-9124	52	1321.0
△ 27681	6AB-4MPX-4MPX-60	7745-9125	60	1524.0
△ 27682	6AB-4MPX-4MPX-66	7745-9126	66	1676.0
△ 27683	6AB-4MPX-4MPX-72	7745-9127	72	1829.0
△ 27684	6AB-4MPX-4MPX-84	7745-9128	84	2134.0

△ WARNING: Cancer and Reproductive Harm - www.P65Warnings.ca.gov

3/8" ID Hose with 3/8" Male Pipe NPTF Swivel at Both Ends



Part No.	Descr.	Prod. No.	Length	
			"	mm
△ 27630	6AB-6MPX-6MPX-08	7745-9098	8	203.0
△ 27631	6AB-6MPX-6MPX-12	7745-9099	12	305.0
△ 27633	6AB-6MPX-6MPX-16	7745-9100	16	406.0
△ 27635	6AB-6MPX-6MPX-20	7745-9101	20	51.0
△ 27637	6AB-6MPX-6MPX-24	7745-9102	24	610.0
△ 27639	6AB-6MPX-6MPX-28	7745-9103	28	711.0
△ 27641	6AB-6MPX-6MPX-32	7745-9104	32	813.0
△ 27643	6AB-6MPX-6MPX-36	7745-9105	36	914.4
△ 27646	6AB-6MPX-6MPX-42	7745-9106	42	1067.0
△ 27648	6AB-6MPX-6MPX-45	7745-9107	45	1143.0
△ 27650	6AB-6MPX-6MPX-48	7745-9108	48	1219.0
△ 27652	6AB-6MPX-6MPX-52	7745-9109	52	1321.0
△ 27654	6AB-6MPX-6MPX-60	7745-9110	60	1524.0
△ 27655	6AB-6MPX-6MPX-66	7745-9111	66	1676.0
△ 27656	6AB-6MPX-6MPX-72	7745-9112	72	1829.0
△ 27657	6AB-6MPX-6MPX-84	7745-9113	84	2134.0

△ WARNING: Cancer and Reproductive Harm - www.P65Warnings.ca.gov



### 3/8" ID Hose with 3/8" Female SAE Swivel at Both Ends



Part No.	Descr.	Prod. No.	Length	
			"	mm
△ 27685	6AB-6FSX-6FSX-18	7745-9129	18	457.0
△ 27686	6AB-6FSX-6FSX-24	7745-9130	24	610.0
△ 27687	6AB-6FSX-6FSX-30	7745-9131	30	762.0
△ 27688	6AB-6FSX-6FSX-36	7745-9132	36	914.4
△ 27689	6AB-6FSX-6FSX-42	7745-9133	42	1067.0
△ 27690	6AB-6FSX-6FSX-48	7745-9134	48	1219.0
△ 27691	6AB-6FSX-6FSX-54	7745-9135	54	1372.0
△ 27692	6AB-6FSX-6FSX-60	7745-9136	60	1524.0

⚠ WARNING: Cancer and Reproductive Harm - www.P65Warnings.ca.gov

- EQUIPMENT
- HOSE/CPLG. SELECTION
- G8K COUPLINGS
- GLOBAL SPIRAL COUPLINGS
- STAINLESS STEEL SPIRAL
- MEGACRIMP COUPLINGS
- STAINLESS STEEL BRAID
- POWER CRIMP COUPLINGS
- FIELD ATTACHABLE G1 & G2 COUPLINGS
- FIELD ATTACHABLE C5 COUPLINGS
- C14 COUPLINGS
- GL COUPLINGS
- GLX COUPLINGS
- PCTS THERMOPLASTIC COUPLINGS
- POLARSEAL COUPLINGS (ACA)
- POLARSEAL II COUPLINGS (ACC)
- POLARSEAL II COUPLINGS (ACB)
- POWER STEERING
- ADAPTERS
- QUICK DISCONNECT COUPLERS
- BALL VALVES
- LIVE SWIVEL
- ASSEMBLY FABRICATION
- ACCESSORIES
- EQUIPMENT AND PARTS
- KITS
- AIR BRAKE HOSE ASSY
- BRASS



**NOTES**

EQUIPMENT
HOSE/CPLG. SELECTION
G8K COUPLINGS
GLOBAL SPIRAL COUPLINGS
STAINLESS STEEL SPIRAL
MEGACRIMP COUPLINGS
STAINLESS STEEL BRAID
POWER CRIMP COUPLINGS
FIELD ATTACHABLE G1 & G2 COUPLINGS
FIELD ATTACHABLE C5 COUPLINGS
C14 COUPLINGS
GL COUPLINGS
GLX COUPLINGS
PCTS THERMOPLASTIC COUPLINGS
POLARSEAL COUPLINGS (ACA)
POLARSEAL II COUPLINGS (ACC)
POLARSEAL II COUPLINGS (ACB)
POWER STEERING
ADAPTERS
QUICK DISCONNECT COUPLERS
BALL VALVES
LIVE SWIVEL
ASSEMBLY FABRICATION
ACCESSORIES
EQUIPMENT AND PARTS
KITS
AIR BRAKE HOSE ASSY
BRASS



# AIR BRAKE COUPLINGS FOR RUBBER HOSE

**Recommended For:** Air brake systems on trucks and buses. Offering includes a broad range of application coverage for use in the air brake system and with AB Series Rubber Air Brake Hose.

**Used With:** AB Series Rubber Air Brake Hose. **NOT** recommended for Nylon Air Brake Tubing.

**Features and Benefits:** Many fittings can be detached and reattached for reuse.

**Conformance:** Meets SAE J1402 and D.O.T. FMVSS-106 requirements.

**Working Pressure:** 225 psi (15 bar)

**Maximum Burst Pressure:** 900 psi (62 bar)

**Temperature Range:** -63°F to +250°F (-52° to +121°C)

**Material:** 360 Brass

EQUIPMENT
HOSE/CPLG. SELECTION
G8K COUPLINGS
GLOBALSPIRAL COUPLINGS
STAINLESS STEEL SPIRAL
MEGACRIMP COUPLINGS
STAINLESS STEEL BRAID
POWER CRIMP COUPLINGS
FIELD ATTACHABLE G1 & G2 COUPLINGS
FIELD ATTACHABLE C5 COUPLINGS
C14 COUPLINGS
GL COUPLINGS
GLX COUPLINGS
PCTS THERMOPLASTIC COUPLINGS
POLARSEAL COUPLINGS (ACA)
POLARSEAL II COUPLINGS (ACC)
POLARSEAL II COUPLINGS (ACB)
POWER STEERING
ADAPTERS
QUICK DISCONNECT COUPLERS
BALL VALVES
LIVE SWIVEL
ASSEMBLY FABRICATION
ACCESSORIES
EQUIPMENT AND PARTS
KITS
AIR BRAKE HOSE ASSY
BRASS



EQUIPMENT
HOSE/CPLG. SELECTION
G8K COUPLINGS
GLOBAL SPIRAL COUPLINGS
STAINLESS STEEL SPIRAL
MEGACRIMP COUPLINGS
STAINLESS STEEL BRAID
POWER CRIMP COUPLINGS
FIELD ATTACHABLE G1 & G2 COUPLINGS
FIELD ATTACHABLE C5 COUPLINGS
C14 COUPLINGS
GL COUPLINGS
GLX COUPLINGS
PCTS THERMOPLASTIC COUPLINGS
POLARSEAL COUPLINGS (ACA)
POLARSEAL II COUPLINGS (ACC)
POLARSEAL II COUPLINGS (ACB)
POWER STEERING
ADAPTERS
QUICK DISCONNECT COUPLERS
BALL VALVES
LIVE SWIVEL
ASSEMBLY FABRICATION
ACCESSORIES
EQUIPMENT AND PARTS
KITS
AIR BRAKE HOSE ASSY
BRASS

## Male Air Brake to Male Pipe Adapter

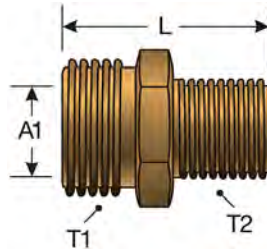

Part No.	Descr.	Prod. No.	A1		T1		T2		L	
			"	mm	(in)	(in)	"	mm		
△ G33030-0604	6MAB-4MP	7250-03175	3/8	9.7	3/4-20	1/4-18	1.06	26.9		
△ G33030-0606	6MAB-6MP	7250-03185	3/8	9.7	3/4-20	3/8-18	1.12	28.5		
△ G33030-0608	6MAB-8MP	7250-03195	3/8	9.7	3/4-20	1/2-14	1.18	30.0		
△ G33030-0806	8MAB-6MP	7250-03205	1/2	12.7	7/8-20	3/8-18	1.18	30.0		
△ G33030-0808	8MAB-8MP	7250-03215	1/2	12.7	7/8-20	1/2-14	1.37	34.8		

△ WARNING: Cancer and Reproductive Harm - www.P65Warnings.ca.gov

## Gladhand

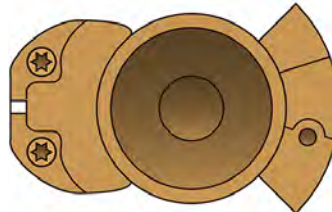

Part No.	Descr.	Prod. No.	Type
△ G33031-0508	8GH-S	7250-03225	Service
△ G33031-0608	8GH-U	7250-03235	Universal
△ G33031-0708	8GH-E	7250-03245	Emergency

△ WARNING: Cancer and Reproductive Harm - www.P65Warnings.ca.gov





### Gladhand Seal



Part No.	Descr.	Prod. No.
G33032-0006	6GH-SEAL	7250-15595

### Sleeve

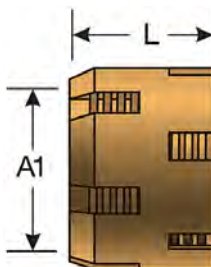

Part No.	Descr.	Prod. No.	A1		L	
			"	mm	"	mm
△ G33050-0006	6TS-6ABR	7250-03265	3/8	9.7	.69	17.5
△ G33050-0008	8TS-8ABR	7250-03275	1/2	12.7	.69	17.5

⚠ WARNING: Cancer and Reproductive Harm - www.P65Warnings.ca.gov

### Nut

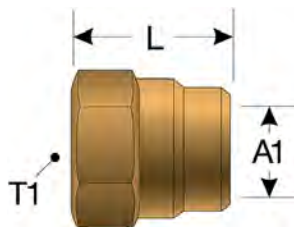

Part No.	Descr.	Prod. No.	A1		T1 (in)	L	
			"	mm		"	mm
△ G33060-0006	6TSN-6ABR	7250-03295	3/8	9.7	1 1/16	1.12	28.5
△ G33060-0008	8TSN-8ABR	7250-03305	1/2	12.7	1 1/4	1.12	28.5

⚠ WARNING: Cancer and Reproductive Harm - www.P65Warnings.ca.gov

- EQUIPMENT
- HOSE/CPLG. SELECTION
- G8K COUPLINGS
- GLOBALSPIRAL COUPLINGS
- STAINLESS STEEL SPIRAL
- MEGACRIMP COUPLINGS
- STAINLESS STEEL BRAID
- POWER CRIMP COUPLINGS
- FIELD ATTACHABLE G1 & G2 COUPLINGS
- FIELD ATTACHABLE C5 COUPLINGS
- C14 COUPLINGS
- GL COUPLINGS
- GLX COUPLINGS
- PCTS THERMOPLASTIC COUPLINGS
- POLARSEAL COUPLINGS (ACA)
- POLARSEAL II COUPLINGS (ACC)
- POLARSEAL II COUPLINGS (ACB)
- POWER STEERING
- ADAPTERS
- QUICK DISCONNECT COUPLERS
- BALL VALVES
- LIVE SWIVEL
- ASSEMBLY FABRICATION
- ACCESSORIES
- EQUIPMENT AND PARTS
- KITS
- AIR BRAKE HOSE ASSY
- BRASS



EQUIPMENT
HOSE/CPLG. SELECTION
G8K COUPLINGS
GLOBAL SPIRAL COUPLINGS
STAINLESS STEEL SPIRAL
MEGACRIMP COUPLINGS
STAINLESS STEEL BRAID
POWER CRIMP COUPLINGS
FIELD ATTACHABLE G1 & G2 COUPLINGS
FIELD ATTACHABLE C5 COUPLINGS
C14 COUPLINGS
GL COUPLINGS
GLX COUPLINGS
PCTS THERMOPLASTIC COUPLINGS
POLARSEAL COUPLINGS (ACA)
POLARSEAL II COUPLINGS (ACC)
POLARSEAL II COUPLINGS (ACB)
POWER STEERING
ADAPTERS
QUICK DISCONNECT COUPLERS
BALL VALVES
LIVE SWIVEL
ASSEMBLY FABRICATION
ACCESSORIES
EQUIPMENT AND PARTS
KITS
AIR BRAKE HOSE ASSY
BRASS

### Spring Guard Nut

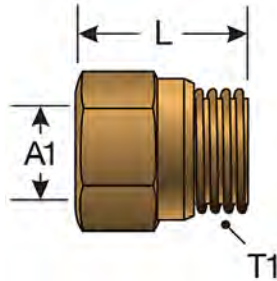

Part No.	Descr.	Prod. No.	A1		T1 (in)	L	
			"	mm		"	mm
△ G33061-0006	6SGN-6ABR	7250-03315	3/8	9.7	1 1/16	1.22	31.0
△ G33061-0008	8SGN-8ABR	7250-03325	1/2	12.7	1 1/4	1.19	30.2

⚠ WARNING: Cancer and Reproductive Harm - www.P65Warnings.ca.gov

### Air Brake to Male Pipe with Nut and Sleeve

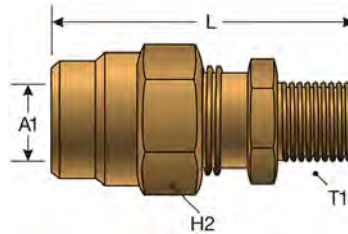

Part No.	Descr.	Prod. No.	A1		T1 (in)	H2	L	
			"	mm			"	mm
△ G33100-0604	6ABR-4MP	7250-03335	3/8	9.7	1/4-18	31/32	2.12	53.9
△ G33100-0606	6ABR-6MP	7250-03345	3/8	9.7	3/8-18	31/32	2.12	53.9
△ G33100-0608	6ABR-8MP	7250-03355	3/8	9.7	1/2-14	31/32	2.27	57.7
△ G33100-0806	8ABR-6MP	7250-03365	1/2	12.7	3/8-18	1 1/8	2.13	54.1
△ G33100-0808	8ABR-8MP	7250-03375	1/2	12.7	1/2-14	1 1/8	2.29	58.2

⚠ WARNING: Cancer and Reproductive Harm - www.P65Warnings.ca.gov



### Air Brake to Male Pipe with Spring Guard

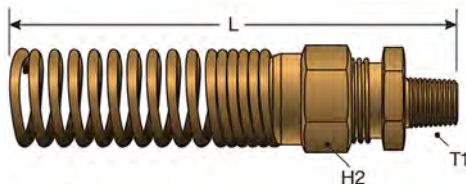

Part No.	Descr.	Prod. No.	T1 (in)		H2	L	
			"	mm		"	mm
△ G33110-0604	6ABRSG-4MP	7250-03385	1/4-18		31/32	4.80	121.9
△ G33110-0606	6ABRSG-6MP	7250-03395	3/8-18		31/32	4.80	121.9
△ G33110-0608	6ABRSG-8MP	7250-03405	1/2-14		31/32	4.90	124.5
△ G33110-0806	8ABRSG-6MP	7250-03415	3/8-18		1 1/8	5.00	127.0
△ G33110-0808	8ABRSG-8MP	7250-03425	1/2-14		1 1/8	5.20	132.1

⚠ WARNING: Cancer and Reproductive Harm - www.P65Warnings.ca.gov

### Air Brake to Male Pipe without Nut and Sleeve

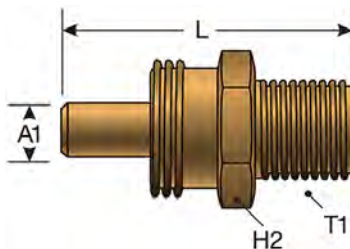

Part No.	Descr.	Prod. No.	A1		T1 (in)	H2	L	
			"	mm			"	mm
△ G33111-0604	6ABRI-4MP	7250-03435	3/8	9.7	1/4-18	31/32	1.91	48.5
△ G33111-0606	6ABRI-6MP	7250-03445	3/8	9.7	3/8-18	31/32	1.91	48.5
△ G33111-0608	6ABRI-8MP	7250-03455	3/8	9.7	1/2-14	31/32	2.06	52.3
△ G33111-0806	8ABRI-6MP	7250-03465	1/2	12.7	3/8-18	1 1/8	1.90	48.3
△ G33111-0808	8ABRI-8MP	7250-03475	1/2	12.7	1/2-14	1 1/8	2.07	52.6

⚠ WARNING: Cancer and Reproductive Harm - www.P65Warnings.ca.gov

### Air Brake Spring Guard

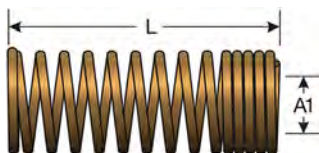

Part No.	Descr.	Prod. No.	A1		L
			"	mm	
△ G33112-0006	6SGABR	7250-03485	3/8	9.7	2.75
△ G33112-0008	8SGABR	7250-03495	1/2	12.7	3.00

⚠ WARNING: Cancer and Reproductive Harm - www.P65Warnings.ca.gov

EQUIPMENT
HOSE/CPLG. SELECTION
G8K COUPLINGS
GLOBALSPIRAL COUPLINGS
STAINLESS STEEL SPIRAL
MEGACRIMP COUPLINGS
STAINLESS STEEL BRAID
POWER CRIMP COUPLINGS
FIELD ATTACHABLE G1 & G2 COUPLINGS
FIELD ATTACHABLE C5 COUPLINGS
C14 COUPLINGS
GL COUPLINGS
GLX COUPLINGS
PCTS THERMOPLASTIC COUPLINGS
POLARSEAL COUPLINGS (ACA)
POLARSEAL II COUPLINGS (ACC)
POLARSEAL II COUPLINGS (ACB)
POWER STEERING
ADAPTERS
QUICK DISCONNECT COUPLERS
BALL VALVES
LIVE SWIVEL
ASSEMBLY FABRICATION
ACCESSORIES
EQUIPMENT AND PARTS
KITS
AIR BRAKE HOSE ASSY
BRASS



EQUIPMENT
HOSE/CPLG. SELECTION
G8K COUPLINGS
GLOBAL SPIRAL COUPLINGS
STAINLESS STEEL SPIRAL
MEGACRIMP COUPLINGS
STAINLESS STEEL BRAID
POWER CRIMP COUPLINGS
FIELD ATTACHABLE G1 & G2 COUPLINGS
FIELD ATTACHABLE C5 COUPLINGS
C14 COUPLINGS
GL COUPLINGS
GLX COUPLINGS
PCTS THERMOPLASTIC COUPLINGS
POLARSEAL COUPLINGS (ACA)
POLARSEAL II COUPLINGS (ACC)
POLARSEAL II COUPLINGS (ACB)
POWER STEERING
ADAPTERS
QUICK DISCONNECT COUPLERS
BALL VALVES
LIVE SWIVEL
ASSEMBLY FABRICATION
ACCESSORIES
EQUIPMENT AND PARTS
KITS
AIR BRAKE HOSE ASSY
BRASS

### Air Brake to Female Air Brake Swivel

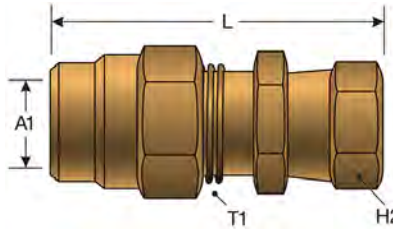

Part No.	Descr.	Prod. No.	A1			H2	L	
			"	mm	T1 (in)	"	"	mm
△ G33150-0606	6ABR-6FABX	7250-03505	3/8	9.7	3/4-20	31/32	2.30	58.4
△ G33150-0808	8ABR-8FABX	7250-03515	1/2	12.7	7/8-20	1 1/8	2.36	59.9

⚠ WARNING: Cancer and Reproductive Harm - www.P65Warnings.ca.gov

### Air Brake to Female Air Brake Swivel with Adapter

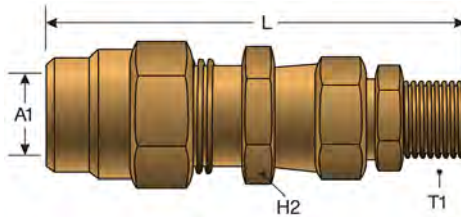

Part No.	Descr.	Prod. No.	A1			H2	L	
			"	mm	T1 (in)	"	"	mm
△ G33151-0604	6ABR-6FABX-4MPA	7250-03525	3/8	9.7	1/4-18	15/16	2.94	74.7
△ G33151-0606	6ABR-6FABX-6MPA	7250-03535	3/8	9.7	3/8-18	1 1/8	2.94	74.7
△ G33151-0608	6ABR-8FABX-8MPA	7250-03545	3/8	9.7	1/2-14	1 1/8	2.94	74.7
△ G33151-0806	8ABR-6FABX-6MPA	7250-15605	1/2	12.7	3/8-18	1 1/8	2.94	74.7

⚠ WARNING: Cancer and Reproductive Harm - www.P65Warnings.ca.gov

### Air Brake Union

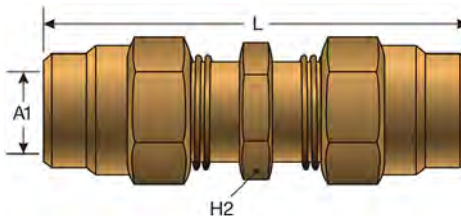

Part No.	Descr.	Prod. No.	A1		H2	L	
			"	mm	"	"	mm
△ G33400-0606	6ABR-6ABR	7250-03625	3/8	9.7	31/32	2.98	75.7
△ G33400-0808	8ABR-8ABR	7250-03635	1/2	12.7	1 1/8	2.99	75.9

⚠ WARNING: Cancer and Reproductive Harm - www.P65Warnings.ca.gov



# BRASS LOCK-ON FIELD ATTACHABLE COUPLINGS FOR LOC & LOL HOSE

**Recommended For:** Fuel lines, fluid lines or vacuum lines in low and medium pressure applications.

**Used With:** LOC and LOL Hose

**Features and Benefits:** Lock-On barbed stem fittings are quick connecting and resistant to damage from high vibration diesel applications. Hose clamps or ferrules are not needed or recommended.

**Working Pressure:** 300 psi (21 bar)

**Temperature Range:** -40°F to 250°F (-40°C to +121°C)

**Material:** 360 Brass

## Assembly Instructions:

1. Measure and mark the hose length to be cut. When cutting, be sure to make the cut as even as possible. We recommended using a hand held hose cutter or a sharp knife.
2. Lubricate the hose and/or fittings with light oil or soapy water. Heavy oils or grease are not recommended as a lubricant.
3. Insert fitting until the first barb is in the hose.
4. Place the fitting end against a flat hard surface, such as a work bench, to finish inserting the fitting stem into the hose. You'll need to grip the hose approximately one inch from the end of the fitting and push until the end of the hose is fully over the stem and against the yellow plastic stop cap or the stop below the hex on the fitting. Note: a yellow stop cap is normally part of a Lock-On fitting.

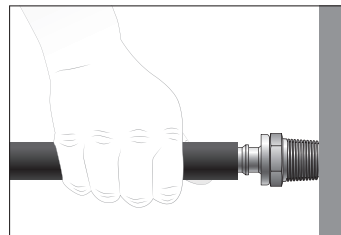

## Precautions:

- Make sure the Lock-On fitting is fully inserted into the hose. Lock-On fittings will properly grip hose only when pushed all the way in, with the cut end of the hose completely concealed by the plastic cap.
- Using clamps with LOC Lock-On fittings is not recommended. Clamps will damage the seal causing leaks and an unsafe assembly.

## Lock-On Fitting and Hose Disassembly Instructions:

1. Secure the fitting using a vise, sturdy workbench or other stable surface.
2. Starting at the yellow plastic stop cap, carefully cut the hose lengthwise approximately one inch away from the yellow stop cap.

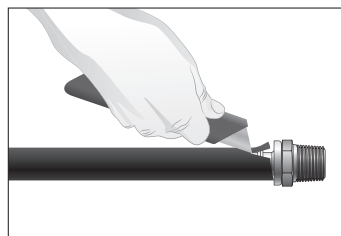

3. Cut slowly, making sure not to nick the fitting barbs.
4. Grip the hose firmly and give it a sharp downward tug away from the fitting to separate the fitting from the hose.

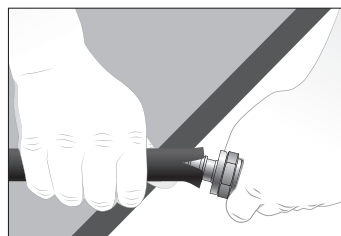

EQUIPMENT
HOSE/CPLG. SELECTION
G8K COUPLINGS
GLOBALSPIRAL COUPLINGS
STAINLESS STEEL SPIRAL
MEGACRIMP COUPLINGS
STAINLESS STEEL BRAID
POWER CRIMP COUPLINGS
FIELD ATTACHABLE G1 & G2 COUPLINGS
FIELD ATTACHABLE C5 COUPLINGS
C14 COUPLINGS
GL COUPLINGS
GLX COUPLINGS
PCTS THERMOPLASTIC COUPLINGS
POLARSEAL COUPLINGS (ACA)
POLARSEAL II COUPLINGS (ACC)
POLARSEAL II COUPLINGS (ACB)
POWER STEERING
ADAPTERS
QUICK DISCONNECT COUPLERS
BALL VALVES
LIVE SWIVEL
ASSEMBLY FABRICATION
ACCESSORIES
EQUIPMENT AND PARTS
KITS
AIR BRAKE HOSE ASSY
BRASS



EQUIPMENT
HOSE/CPLG. SELECTION
G8K COUPLINGS
GLOBALSPIRAL COUPLINGS
STAINLESS STEEL SPIRAL
MEGACRIMP COUPLINGS
STAINLESS STEEL BRAID
POWER CRIMP COUPLINGS
FIELD ATTACHABLE G1 & G2 COUPLINGS
FIELD ATTACHABLE C5 COUPLINGS
C14 COUPLINGS
GL COUPLINGS
GLX COUPLINGS
PCTS THERMOPLASTIC COUPLINGS
POLARSEAL COUPLINGS (ACA)
POLARSEAL II COUPLINGS (ACC)
POLARSEAL II COUPLINGS (ACB)
POWER STEERING
ADAPTERS
QUICK DISCONNECT COUPLERS
BALL VALVES
LIVE SWIVEL
ASSEMBLY FABRICATION
ACCESSORIES
EQUIPMENT AND PARTS
KITS
AIR BRAKE HOSE ASSY
BRASS

### Male Pipe with Cone Seat

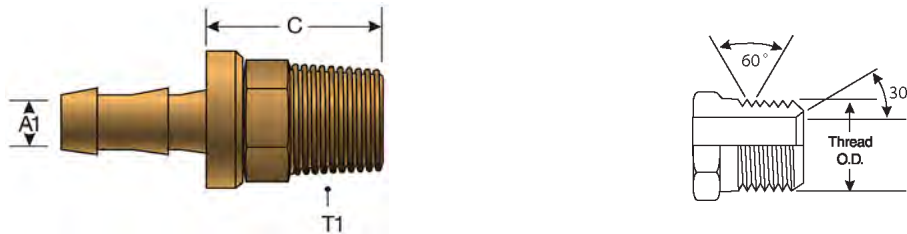

Part No.	Descr.	Prod. No.	A1		T1 (in)	C	
			"	mm		"	mm
△ G36100-0402	4LOC-2RMP	7250-04435	1/4	6.4	1/8-27	.56	14.2
△ G36100-0404	4LOC-4RMP	7250-04445	1/4	6.4	1/4-18	.81	20.6
△ G36100-0406	4LOC-6RMP	7250-16065	1/4	6.4	3/8-18	.88	22.4
△ G36100-0502	5LOC-2RMP	7250-04455	5/16	7.9	1/8-27	.81	20.6
△ G36100-0504	5LOC-4RMP	7250-04465	5/16	7.9	1/4-18	.77	19.6
△ G36100-0602	6LOC-2RMP	7250-04475	3/8	9.5	1/8-27	.56	14.2
△ G36100-0604	6LOC-4RMP	7250-04485	3/8	9.5	1/4-18	.81	20.6
△ G36100-0606	6LOC-6RMP	7250-04495	3/8	9.5	3/8-18	.88	22.4
△ G36100-0608	6LOC-8RMP	7250-16075	3/8	9.5	1/2-14	.88	22.4
△ G36100-0804	8LOC-4RMP	7250-16085	1/2	12.7	1/4-18	.81	20.6
△ G36100-0806	8LOC-6RMP	7250-04505	1/2	12.7	3/8-18	.88	22.4
△ G36100-0808	8LOC-8RMP	7250-04515	1/2	12.7	1/2-14	.88	22.4
△ G36100-0812	8LOC-12RMP	7250-16095	1/2	12.7	3/4-14	1.13	28.7
△ G36100-1006	10LOC-6RMP	7250-16105	5/8	15.9	3/8-18	.88	22.4
△ G36100-1008	10LOC-8RMP	7250-04525	5/8	15.9	1/2-14	1.06	26.9
△ G36100-1012	10LOC-12RMP	7250-16115	5/8	15.9	3/4-14	.88	22.4
△ G36100-1208	12LOC-8RMP	7250-16125	3/4	19.1	1/2-14	.88	22.4
△ G36100-1212	12LOC-12RMP	7250-04535	3/4	19.1	3/4-14	1.13	28.7

△ WARNING: Cancer and Reproductive Harm - www.P65Warnings.ca.gov

### Male Pipe Swivel without Cone Seat

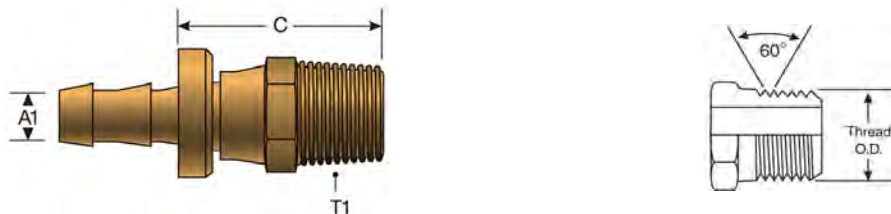

Part No.	Descr.	Prod. No.	A1		T1 (in)	C	
			"	mm		"	mm
△ G36105-0404	4LOC-4RMPX	7250-16135	1/4	6.4	1/4-18	1.81	46.0
△ G36105-0606	6LOC-6RMPX	7250-16145	3/8	9.5	3/8-18	2.00	50.8
△ G36105-0808	8LOC-8RMPX	7250-16155	1/2	12.7	1/2-14	2.38	60.5
△ G36105-1212	12LOC-12RMPX	7250-16165	3/4	19.1	3/4-14	2.68	68.1

△ WARNING: Cancer and Reproductive Harm - www.P65Warnings.ca.gov



# BRASS LOCK-ON FIELD ATTACHABLE COUPLINGS FOR LOC & LOL HOSE

## Male Pipe 90° Block with Cone Seat



Part No.	Descr.	Prod. No.	A1		T1 (in)	C	
			"	mm		"	mm
△ G36106-0402	4LOC-2RMP90	7250-16175	1/4	6.4	1/8-27	.31	7.9
△ G36106-0404	4LOC-4RMP90	7250-16185	1/4	6.4	1/4-18	.38	9.7
△ G36106-0502	5LOC-2RMP90	7250-04555	5/16	7.9	1/8-27	.31	7.9
△ G36106-0504	5LOC-4RMP90	7250-04565	5/16	7.9	1/4-18	.38	9.7
△ G36106-0602	6LOC-2RMP90	7250-04575	3/8	9.5	1/8-27	.38	9.7
△ G36106-0604	6LOC-4RMP90	7250-04585	3/8	9.5	1/4-18	.40	10.2
△ G36106-0606	6LOC-6RMP90	7250-16195	3/8	9.5	3/8-18	.43	10.9
△ G36106-0808	8LOC-8RMP90	7250-16205	1/2	12.7	1/2-14	.50	12.7
△ G36106-1212	12LOC-12RMP90	7250-16215	3/4	19.1	3/4-14	.76	19.3

⚠ WARNING: Cancer and Reproductive Harm - www.P65Warnings.ca.gov

## Female Pipe without Cone Seat

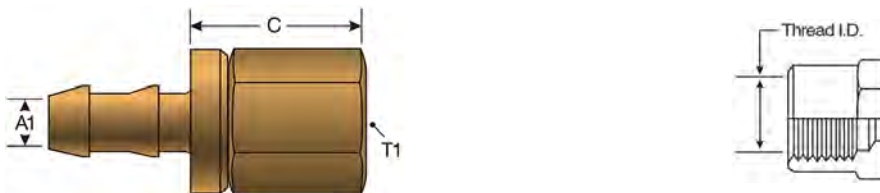

Part No.	Descr.	Prod. No.	A1		T1 (in)	C	
			"	mm		"	mm
△ G36110-0404	4LOC-4RFP	7250-04595	1/4	6.4	1/4-18	.50	12.7
△ G36110-0504	5LOC-4RFP	7250-16225	5/16	7.9	1/4-18	.50	12.7
△ G36110-0606	6LOC-6RFP	7250-04605	3/8	9.5	3/8-18	.63	16.0
△ G36110-0806	8LOC-6RFP	7250-16235	1/2	12.7	3/8-18	.63	16.0
△ G36110-0808	8LOC-8RFP	7250-04615	1/2	12.7	1/2-14	.75	19.1
△ G36110-1008	10LOC-8RFP	7250-16245	5/8	15.9	1/2-14	.75	19.1
△ G36110-1212	12LOC-12RFP	7250-16255	3/4	19.1	3/4-14	.93	23.6

⚠ WARNING: Cancer and Reproductive Harm - www.P65Warnings.ca.gov

- EQUIPMENT
- HOSE/CPLG. SELECTION
- G8K COUPLINGS
- GLOBALSPIRAL COUPLINGS
- STAINLESS STEEL SPIRAL
- MEGACRIMP COUPLINGS
- STAINLESS STEEL BRAID
- POWER CRIMP COUPLINGS
- FIELD ATTACHABLE G1 & G2 COUPLINGS
- FIELD ATTACHABLE C5 COUPLINGS
- C14 COUPLINGS
- GL COUPLINGS
- GLX COUPLINGS
- PCTS THERMOPLASTIC COUPLINGS
- POLARSEAL COUPLINGS (ACA)
- POLARSEAL II COUPLINGS (ACC)
- POLARSEAL II COUPLINGS (ACB)
- POWER STEERING
- ADAPTERS
- QUICK DISCONNECT COUPLERS
- BALL VALVES
- LIVE SWIVEL
- ASSEMBLY FABRICATION
- ACCESSORIES
- EQUIPMENT AND PARTS
- KITS
- AIR BRAKE HOSE ASSY
- BRASS





EQUIPMENT
HOSE/CPLG. SELECTION
G8K COUPLINGS
GLOBAL SPIRAL COUPLINGS
STAINLESS STEEL SPIRAL
MEGACRIMP COUPLINGS
STAINLESS STEEL BRAID
POWER CRIMP COUPLINGS
FIELD ATTACHABLE G1 & G2 COUPLINGS
FIELD ATTACHABLE C5 COUPLINGS
C14 COUPLINGS
GL COUPLINGS
GLX COUPLINGS
PCTS THERMOPLASTIC COUPLINGS
POLARSEAL COUPLINGS (ACA)
POLARSEAL II COUPLINGS (ACC)
POLARSEAL II COUPLINGS (ACB)
POWER STEERING
ADAPTERS
QUICK DISCONNECT COUPLERS
BALL VALVES
LIVE SWIVEL
ASSEMBLY FABRICATION
ACCESSORIES
EQUIPMENT AND PARTS
KITS
AIR BRAKE HOSE ASSY
BRASS

## Female Pipe Swivel with Cone Seat

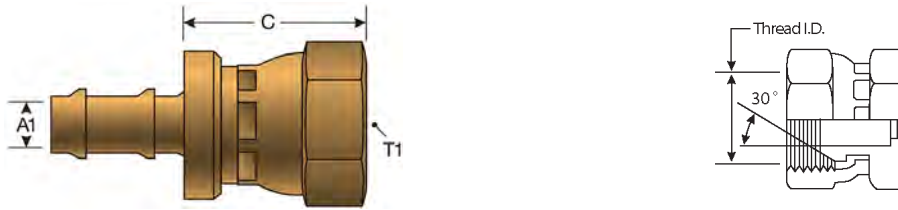

Part No.	Descr.	Prod. No.	A1		T1 (in)	C	
			"	mm		"	mm
△ G36111-0402	4LOC-2RFPX	7250-16265	1/4	6.4	1/8-27	1.81	46.0
△ G36111-0404	4LOC-4RFPX	7250-16275	1/4	6.4	1/4-18	1.81	46.0
△ G36111-0406	4LOC-6RFPX	7250-16285	1/4	6.4	3/8-18	2.00	50.8
△ G36111-0604	6LOC-4RFPX	7250-16295	3/8	9.5	1/4-18	1.81	46.0
△ G36111-0606	6LOC-6RFPX	7250-16305	3/8	9.5	3/8-18	2.00	50.8
△ G36111-0608	6LOC-8RFPX	7250-16315	3/8	9.5	1/2-14	2.38	60.5
△ G36111-0808	8LOC-8RFPX	7250-16325	1/2	12.7	1/2-14	2.38	60.5
△ G36111-0812	8LOC-12RFPX	7250-16335	1/2	12.7	3/4-14	2.68	68.1
△ G36111-1012	10LOC-12RFPX	7250-16345	5/8	15.9	3/4-14	2.68	68.1
△ G36111-1212	12LOC-12RFPX	7250-16355	3/4	19.1	3/4-14	2.68	68.1

△ WARNING: Cancer and Reproductive Harm - www.P65Warnings.ca.gov

## Male JIC 37° Flare

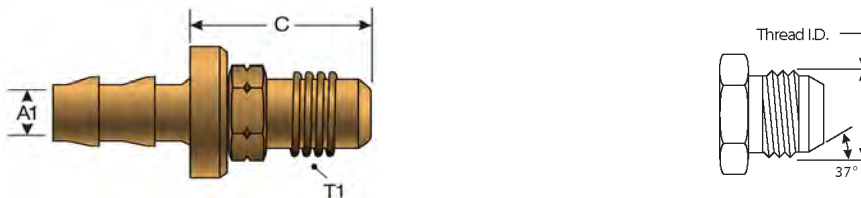

Part No.	Descr.	Prod. No.	A1		T1 (in)	C	
			"	mm		"	mm
△ G36165-0404	4LOC-4RMJ	7250-16365	1/4	6.4	7/16-20	.81	20.6
△ G36165-0405	4LOC-5RMJ	7250-16375	1/4	6.4	1/2-20	.94	23.9
△ G36165-0406	4LOC-6RMJ	7250-16385	1/4	6.4	9/16-18	1.00	25.4
△ G36165-0604	6LOC-4RMJ	7250-16395	3/8	9.5	7/16-20	.88	22.4
△ G36165-0605	6LOC-5RMJ	7250-16405	3/8	9.5	1/2-20	.94	23.9
△ G36165-0606	6LOC-6RMJ	7250-16415	3/8	9.5	9/16-18	1.00	25.4
△ G36165-0608	6LOC-8RMJ	7250-16425	3/8	9.5	3/4-16	1.19	30.2
△ G36165-0808	8LOC-8RMJ	7250-16435	1/2	12.7	3/4-16	1.19	30.2
△ G36165-0810	8LOC-10RMJ	7250-16445	1/2	12.7	7/8-14	1.27	32.3
△ G36165-1008	10LOC-8RMJ	7250-16455	5/8	15.9	3/4-16	1.19	30.2
△ G36165-1010	10LOC-10RMJ	7250-16465	5/8	15.9	7/8-14	1.27	32.3
△ G36165-1210	12LOC-10RMJ	7250-16475	3/4	19.1	7/8-14	1.27	32.3
△ G36165-1212	12LOC-12RMJ	7250-16485	3/4	19.1	1 1/16-12	1.33	33.8

△ WARNING: Cancer and Reproductive Harm - www.P65Warnings.ca.gov





### Female JIC 37° Flare Swivel



Part No.	Descr.	Prod. No.	A1		T1 (in)	C	
			"	mm		"	mm
△ G36170-0406	4LOC-6RFJX	7250-16495	1/4	6.4	9/16-18	.74	18.8
△ G36170-0606	6LOC-6RFJX	7250-04625	3/8	9.5	9/16-18	.81	20.6
△ G36170-1212	12LOC-12RFJX	7250-04635	3/4	19.1	1 1/16-12	1.09	27.7

△ WARNING: Cancer and Reproductive Harm - www.P65Warnings.ca.gov

### Male SAE 45° Flare

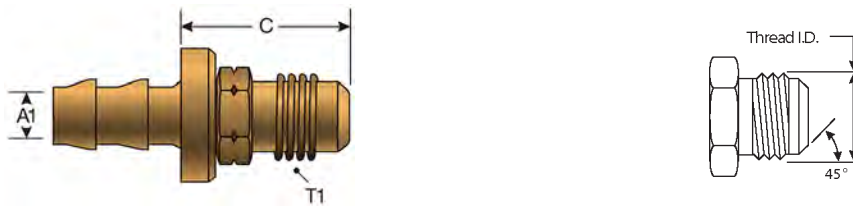

Part No.	Descr.	Prod. No.	A1		T1 (in)	C	
			"	mm		"	mm
△ G36195-0404	4LOC-4RMS	7250-04645	1/4	6.4	7/16-20	.69	17.5
△ G36195-0405	4LOC-5RMS	7250-04655	1/4	6.4	1/2-20	.38	9.7
△ G36195-0406	4LOC-6RMS	7250-04665	1/4	6.4	5/8-18	.88	22.4
△ G36195-0505	5LOC-5RMS	7250-04675	5/16	7.9	1/2-20	.81	20.6
△ G36195-0604	6LOC-4RMS	7250-16505	3/8	9.5	7/16-20	.69	17.5
△ G36195-0605	6LOC-5RMS	7250-16515	3/8	9.5	1/2-20	.81	20.6
△ G36195-0606	6LOC-6RMS	7250-04685	3/8	9.5	5/8-18	.88	22.4
△ G36195-0608	6LOC-8RMS	7250-16525	3/8	9.5	3/4-16	1.31	33.3
△ G36195-0808	8LOC-8RMS	7250-18285	1/2	12.7	3/4-16	1.13	28.7
△ G36195-0810	8LOC-10RMS	7250-16535	1/2	12.7	7/8-14	1.27	32.3
△ G36195-1008	10LOC-8RMS	7250-16545	5/8	15.9	3/4-16	1.13	28.7
△ G36195-1010	10LOC-10RMS	7250-16555	5/8	15.9	7/8-14	1.27	32.3
△ G36195-1210	12LOC-10RMS	7250-16565	3/4	19.1	7/8-14	1.27	32.3
△ G36195-1212	12LOC-12RMS	7250-16575	3/4	19.1	1 1/16-14	1.83	46.5

△ WARNING: Cancer and Reproductive Harm - www.P65Warnings.ca.gov

EQUIPMENT
HOSE/CPLG. SELECTION
G8K COUPLINGS
GLOBALSPIRAL COUPLINGS
STAINLESS STEEL SPIRAL
MEGACRIMP COUPLINGS
STAINLESS STEEL BRAID
POWER CRIMP COUPLINGS
FIELD ATTACHABLE G1 & G2 COUPLINGS
FIELD ATTACHABLE C5 COUPLINGS
C14 COUPLINGS
GL COUPLINGS
GLX COUPLINGS
PCTS THERMOPLASTIC COUPLINGS
POLARSEAL COUPLINGS (ACA)
POLARSEAL II COUPLINGS (ACC)
POLARSEAL II COUPLINGS (ACB)
POWER STEERING
ADAPTERS
QUICK DISCONNECT COUPLERS
BALL VALVES
LIVE SWIVEL
ASSEMBLY FABRICATION
ACCESSORIES
EQUIPMENT AND PARTS
KITS
AIR BRAKE HOSE ASSY
BRASS



EQUIPMENT
HOSE/CPLG. SELECTION
G8K COUPLINGS
GLOBAL SPIRAL COUPLINGS
STAINLESS STEEL SPIRAL
MEGACRIMP COUPLINGS
STAINLESS STEEL BRAID
POWER CRIMP COUPLINGS
FIELD ATTACHABLE G1 & G2 COUPLINGS
FIELD ATTACHABLE C5 COUPLINGS
C14 COUPLINGS
GL COUPLINGS
GLX COUPLINGS
PCTS THERMOPLASTIC COUPLINGS
POLARSEAL COUPLINGS (ACA)
POLARSEAL II COUPLINGS (ACC)
POLARSEAL II COUPLINGS (ACB)
POWER STEERING
ADAPTERS
QUICK DISCONNECT COUPLERS
BALL VALVES
LIVE SWIVEL
ASSEMBLY FABRICATION
ACCESSORIES
EQUIPMENT AND PARTS
KITS
AIR BRAKE HOSE ASSY
BRASS

### Female SAE 45° Flare Swivel



Part No.	Descr.	Prod. No.	A1		T1 (in)	C	
			"	mm		"	mm
△ G36200-0406	4LOC-6RFSX	7250-16585	1/4	6.4	5/8-18	.69	17.5
△ G36200-0506	5LOC-6RFSX	7250-18295	5/16	7.9	5/8-18	.81	20.6
△ G36200-0606	6LOC-6RFSX	7250-04695	3/8	9.5	5/8-18	.84	21.3
△ G36200-0806	8LOC-6RFSX	7250-16595	1/2	12.7	5/8-18	.84	21.3
△ G36200-1212	12LOC-12RFSX	7250-04705	3/4	19.1	1 1/16-14	1.09	27.7

⚠ WARNING: Cancer and Reproductive Harm - www.P65Warnings.ca.gov

### Dual Seat Female JIC 37°/SAE 45° Flare Swivel

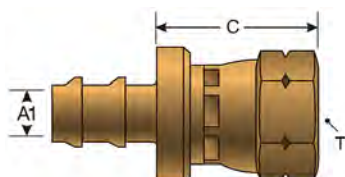

Part No.	Descr.	Prod. No.	A1		T1 (in)	C	
			"	mm		"	mm
△ G36210-0404	4LOC-4RFJSX	7250-04715	1/4	6.4	7/16-20	.75	19.1
△ G36210-0405	4LOC-5RFJSX	7250-04725	1/4	6.4	1/2-20	.78	19.8
△ G36210-0505	5LOC-5RFJSX	7250-04735	5/16	7.9	1/2-20	.81	20.6
△ G36210-0605	6LOC-5RFJSX	7250-04745	3/8	9.5	1/2-20	.81	20.6
△ G36210-0608	6LOC-8RFJSX	7250-18305	3/8	9.5	3/4-16	.97	24.6
△ G36210-0808	8LOC-8RFJSX	7250-04755	1/2	12.7	3/4-16	.97	24.6
△ G36210-0810	8LOC-10RFJSX	7250-18315	1/2	12.7	7/8-14	1.00	25.4
△ G36210-1010	10LOC-10RFJSX	7250-04765	5/8	15.9	7/8-14	1.00	25.4
△ G36210-1210	12LOC-10RFJSX	7250-04775	3/4	19.1	7/8-14	1.00	25.4

⚠ WARNING: Cancer and Reproductive Harm - www.P65Warnings.ca.gov



### Male SAE Inverted Flare Swivel

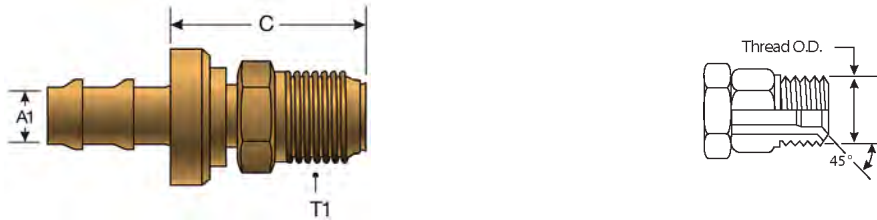

Part No.	Descr.	Prod. No.	A1		T1 (in)	C	
			"	mm		"	mm
△ G36500-0403	4LOC-3RMIX	7250-04785	1/4	6.4	3/8-24	.78	19.8
△ G36500-0404	4LOC-4RMIX	7250-04795	1/4	6.4	7/16-24	.78	19.8
△ G36500-0405	4LOC-5RMIX	7250-04805	1/4	6.4	1/2-20	.78	19.8
△ G36500-0504	5LOC-4RMIX	7250-04815	5/16	7.9	1/2-20	.78	19.8
△ G36500-0505	5LOC-5RMIX	7250-04825	5/16	7.9	1/2-20	.82	20.8
△ G36500-0506	5LOC-6RMIX	7250-04835	5/16	7.9	5/8-18	.86	21.8
△ G36500-0605	6LOC-5RMIX	7250-04845	3/8	9.5	1/2-20	.82	20.8
△ G36500-0606	6LOC-6RMIX	7250-04855	3/8	9.5	5/8-18	.97	24.6
△ G36500-0608	6LOC-8RMIX	7250-16605	3/8	9.5	3/4-18	1.00	25.4
△ G36500-0806	8LOC-6RMIX	7250-16615	1/2	12.7	5/8-18	.97	24.6
△ G36500-0808	8LOC-8RMIX	7250-04865	1/2	12.7	3/4-18	1.00	25.4
△ G36500-1010	10LOC-10RMIX	7250-18325	5/8	15.9	7/8-18	1.00	25.4

⚠ WARNING: Cancer and Reproductive Harm - www.P65Warnings.ca.gov

### Female SAE Inverted Flare



Part No.	Descr.	Prod. No.	A1		T1 (in)	C	
			"	mm		"	mm
△ G36508-0403	4LOC-3RFI	7250-04875	1/4	6.4	3/8-24	.75	19.1
△ G36508-0404	4LOC-4RFI	7250-04885	1/4	6.4	7/16-24	.75	19.1
△ G36508-0405	4LOC-5RFI	7250-04895	1/4	6.4	1/2-20	.75	19.1
△ G36508-0505	5LOC-5RFI	7250-04905	5/16	7.9	1/2-20	.75	19.1
△ G36508-0605	6LOC-5RFI	7250-04915	3/8	9.5	1/2-20	.75	19.1
△ G36508-0606	6LOC-6RFI	7250-04925	3/8	9.5	5/8-18	.88	22.4
△ G36508-0808	8LOC-8RFI	7250-04935	1/2	12.7	5/8-18	.93	23.6

⚠ WARNING: Cancer and Reproductive Harm - www.P65Warnings.ca.gov

- EQUIPMENT
- HOSE/CPLG. SELECTION
- G8K COUPLINGS
- GLOBALSPIRAL COUPLINGS
- STAINLESS STEEL SPIRAL
- MEGACRIMP COUPLINGS
- STAINLESS STEEL BRAID
- POWER CRIMP COUPLINGS
- FIELD ATTACHABLE G1 & G2 COUPLINGS
- FIELD ATTACHABLE C5 COUPLINGS
- C14 COUPLINGS
- GL COUPLINGS
- GLX COUPLINGS
- PCTS THERMOPLASTIC COUPLINGS
- POLARSEAL COUPLINGS (ACA)
- POLARSEAL II COUPLINGS (ACC)
- POLARSEAL II COUPLINGS (ACB)
- POWER STEERING
- ADAPTERS
- QUICK DISCONNECT COUPLERS
- BALL VALVES
- LIVE SWIVEL
- ASSEMBLY FABRICATION
- ACCESSORIES
- EQUIPMENT AND PARTS
- KITS
- AIR BRAKE HOSE ASSY
- BRASS



EQUIPMENT
HOSE/CPLG. SELECTION
G8K COUPLINGS
GLOBAL SPIRAL COUPLINGS
STAINLESS STEEL SPIRAL
MEGACRIMP COUPLINGS
STAINLESS STEEL BRAID
POWER CRIMP COUPLINGS
FIELD ATTACHABLE G1 & G2 COUPLINGS
FIELD ATTACHABLE C5 COUPLINGS
C14 COUPLINGS
GL COUPLINGS
GLX COUPLINGS
PCTS THERMOPLASTIC COUPLINGS
POLARSEAL COUPLINGS (ACA)
POLARSEAL II COUPLINGS (ACC)
POLARSEAL II COUPLINGS (ACB)
POWER STEERING
ADAPTERS
QUICK DISCONNECT COUPLERS
BALL VALVES
LIVE SWIVEL
ASSEMBLY FABRICATION
ACCESSORIES
EQUIPMENT AND PARTS
KITS
AIR BRAKE HOSE ASSY
BRASS

### North American Stand Pipe

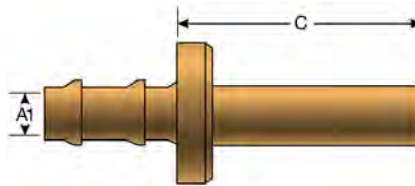

Part No.	Descr.	Prod. No.	A1		C	
			"	mm	"	mm
△ G36520-0403	4LOC-3RFT	7250-04945	1/4	6.4	.75	19.1
△ G36520-0404	4LOC-4RFT	7250-04955	1/4	6.4	1.00	25.4
△ G36520-0405	4LOC-5RFT	7250-04965	1/4	6.4	1.13	28.7
△ G36520-0505	5LOC-5RFT	7250-04975	5/16	7.9	1.13	28.7
△ G36520-0606	6LOC-6RSP	7250-04985	3/8	9.5	1.25	31.8
△ G36520-0808	8LOC-8RSP	7250-16625	1/2	12.7	1.00	25.4
△ G36520-1010	10LOC-10RSP	7250-16635	5/8	15.9	1.00	25.4

△ WARNING: Cancer and Reproductive Harm - www.P65Warnings.ca.gov

### Hose Length Extenders



Part No.	Descr.	Prod. No.	A1	A2
			"	"
△ G36535-0404	4LOC-4RHM	7250-04995	1/4	1/4
△ G36535-0505	5LOC-5RHM	7250-05005	5/16	5/16
△ G36535-0606	6LOC-6RHM	7250-05015	3/8	3/8
△ G36535-0808	8LOC-8RHM	7250-05025	1/2	1/2
△ G36535-1010	10LOC-10RHM	7250-18335	5/8	5/8
△ G36535-1212	12LOC-12RHM	7250-18345	3/4	3/4

△ WARNING: Cancer and Reproductive Harm - www.P65Warnings.ca.gov



### Male British Standard Pipe Tapered

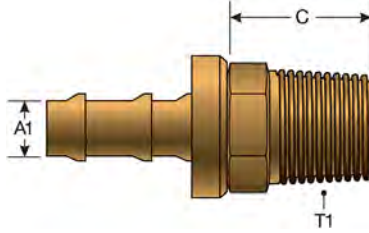

Part No.	Descr.	Prod. No.	A1		T1 (in)	C	
			"	mm		"	mm
△ G36795-0504	5LOC-4MBSPT	7250-10225	5/16	7.9	1/4-19	.63	16.0

⚠ WARNING: Cancer and Reproductive Harm - www.P65Warnings.ca.gov

- EQUIPMENT
- HOSE/CPLG. SELECTION
- G8K COUPLINGS
- GLOBALSPIRAL COUPLINGS
- STAINLESS STEEL SPIRAL
- MEGACRIMP COUPLINGS
- STAINLESS STEEL BRAID
- POWER CRIMP COUPLINGS
- FIELD ATTACHABLE G1 & G2 COUPLINGS
- FIELD ATTACHABLE C5 COUPLINGS
- C14 COUPLINGS
- GL COUPLINGS
- GLX COUPLINGS
- PCTS THERMOPLASTIC COUPLINGS
- POLARSEAL COUPLINGS (ACA)
- POLARSEAL II COUPLINGS (ACC)
- POLARSEAL II COUPLINGS (ACB)
- POWER STEERING
- ADAPTERS
- QUICK DISCONNECT COUPLERS
- BALL VALVES
- LIVE SWIVEL
- ASSEMBLY FABRICATION
- ACCESSORIES
- EQUIPMENT AND PARTS
- KITS
- AIR BRAKE HOSE ASSY
- BRASS

# SINGLE BEAD



EQUIPMENT
HOSE/CPLG. SELECTION
G8K COUPLINGS
GLOBAL SPIRAL COUPLINGS
STAINLESS STEEL SPIRAL
MEGACRIMP COUPLINGS
STAINLESS STEEL BRAID
POWER CRIMP COUPLINGS
FIELD ATTACHABLE G1 & G2 COUPLINGS
FIELD ATTACHABLE C5 COUPLINGS
C14 COUPLINGS
GL COUPLINGS
GLX COUPLINGS
PCTS THERMOPLASTIC COUPLINGS
POLARSEAL COUPLINGS (ACA)
POLARSEAL II COUPLINGS (ACC)
POLARSEAL II COUPLINGS (ACB)
POWER STEERING
ADAPTERS
QUICK DISCONNECT COUPLERS
BALL VALVES
LIVE SWIVEL
ASSEMBLY FABRICATION
ACCESSORIES
EQUIPMENT AND PARTS
KITS
AIR BRAKE HOSE ASSY
BRASS

**Recommended For:** Low pressure fuel, oil, compressed air and water lines used in small engines, vacuum advance and evaporative emission control systems.

**Used With:** Low pressure hose such as multi-purpose or general purpose hose.

**Features and Benefits:** Single bead fittings are quick connecting, field attachable and reusable. An economical choice for general purpose fluid applications. Single bead is sometimes referred to as beaded nipple.

**Conformance:** Contact Gates to verify compliance to desired specifications and suitability for particular applications.

**Working Pressure:** 60 psi (4 bar)

**Temperature Range:** -40°F to +250°F (-40°C to +121°C)

**Material:** 360 Brass

## Assembly Instructions:

1. Cut hose as straight as possible.
2. Slide clamp on hose then lubricate hose or fitting.
3. Push hose on fitting until hose bottoms against hex or stop ring.
4. Position hose clamp between fitting bead on stem and end of hose and tighten.
5. Hose clamps required.



### Male Pipe with Cone Seat

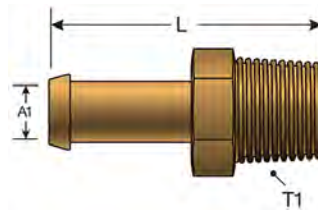

Part No.	Descr.	Prod. No.	A1		T1 (in)	L	
			"	mm		"	mm
△ G37100-0302	3SB-2RMP	7250-05035	3/16	4.8	1/8-27	1.26	32.0
△ G37100-0402	4SB-2RMP	7250-05045	1/4	6.4	1/8-27	1.32	33.5
△ G37100-0404	4SB-4RMP	7250-05055	1/4	6.4	1/4-18	1.63	41.4
△ G37100-0502	5SB-2RMP	7250-05065	5/16	7.9	1/8-27	1.55	39.4
△ G37100-0504	5SB-4RMP	7250-05075	5/16	7.9	1/4-18	1.55	39.4
△ G37100-0602	6SB-2RMP	7250-05085	3/8	9.7	1/8-27	1.55	39.4
△ G37100-0604	6SB-4RMP	7250-05095	3/8	9.7	1/4-18	1.63	41.4
△ G37100-0606	6SB-6RMP	7250-05105	3/8	9.7	3/8-18	1.72	43.7
△ G37100-0806	8SB-6RMP	7250-05115	1/2	12.7	3/8-18	1.72	43.7
△ G37100-0808	8SB-8RMP	7250-05125	1/2	12.7	1/2-14	1.79	45.5
△ G37100-1006	10SB-6RMP	7250-05135	5/8	15.9	3/8-18	1.78	45.2
△ G37100-1008	10SB-8RMP	7250-05145	5/8	15.9	1/2-14	1.78	45.2
△ G37100-1012	10SB-12RMP	7250-16645	5/8	15.9	3/4-14	1.92	48.8
△ G37100-1208	12SB-8RMP	7250-05155	3/4	19.1	1/2-14	1.78	45.2
△ G37100-1212	12SB-12RMP	7250-16655	3/4	19.1	3/4-14	1.92	48.8

⚠ WARNING: Cancer and Reproductive Harm - www.P65Warnings.ca.gov

### Male Straight Thread Connector

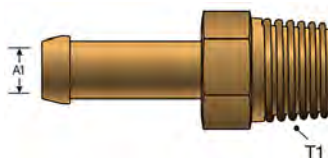

Part No.	Descr.	Prod. No.	A1		T1 (in)
			"	mm	
△ G37103-0609	6SB-9MSC	7250-05165	3/8	9.7	9/16-24
△ G37103-0610	6SB-10MSC	7250-05175	3/8	9.7	5/8-20
△ G37103-0614	6SB-14MSC	7250-05185	3/8	9.7	7/8-20

⚠ WARNING: Cancer and Reproductive Harm - www.P65Warnings.ca.gov

- EQUIPMENT
- HOSE/CPLG. SELECTION
- G8K COUPLINGS
- GLOBALSPIRAL COUPLINGS
- STAINLESS STEEL SPIRAL
- MEGACRIMP COUPLINGS
- STAINLESS STEEL BRAID
- POWER CRIMP COUPLINGS
- FIELD ATTACHABLE G1 & G2 COUPLINGS
- FIELD ATTACHABLE C5 COUPLINGS
- C14 COUPLINGS
- GL COUPLINGS
- GLX COUPLINGS
- PCTS THERMOPLASTIC COUPLINGS
- POLARSEAL COUPLINGS (ACA)
- POLARSEAL II COUPLINGS (ACC)
- POLARSEAL II COUPLINGS (ACB)
- POWER STEERING
- ADAPTERS
- QUICK DISCONNECT COUPLERS
- BALL VALVES
- LIVE SWIVEL
- ASSEMBLY FABRICATION
- ACCESSORIES
- EQUIPMENT AND PARTS
- KITS
- AIR BRAKE HOSE ASSY
- BRASS



EQUIPMENT
HOSE/CPLG. SELECTION
G8K COUPLINGS
GLOBAL SPIRAL COUPLINGS
STAINLESS STEEL SPIRAL
MEGACRIMP COUPLINGS
STAINLESS STEEL BRAID
POWER CRIMP COUPLINGS
FIELD ATTACHABLE G1 & G2 COUPLINGS
FIELD ATTACHABLE C5 COUPLINGS
C14 COUPLINGS
GL COUPLINGS
GLX COUPLINGS
PCTS THERMOPLASTIC COUPLINGS
POLARSEAL COUPLINGS (ACA)
POLARSEAL II COUPLINGS (ACC)
POLARSEAL II COUPLINGS (ACB)
POWER STEERING
ADAPTERS
QUICK DISCONNECT COUPLERS
BALL VALVES
LIVE SWIVEL
ASSEMBLY FABRICATION
ACCESSORIES
EQUIPMENT AND PARTS
KITS
AIR BRAKE HOSE ASSY
BRASS

### Male Pipe 90° Block Cone Seat

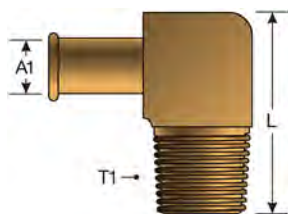

Part No.	Descr.	Prod. No.	A1		T1 (in)	L	
			"	mm		"	mm
△ G37106-0402	4SB-2RMP90	7250-05195	1/4	6.4	1/8-27	1.00	25.4
△ G37106-0502	5SB-2RMP90	7250-05205	5/16	7.9	1/8-27	1.01	25.7
△ G37106-0504	5SB-4RMP90	7250-05215	5/16	7.9	1/4-18	1.01	25.7
△ G37106-0602	6SB-2RMP90	7250-05225	3/8	9.7	1/8-27	1.01	25.7
△ G37106-0604	6SB-4RMP90	7250-05235	3/8	9.7	1/4-18	1.04	26.4
△ G37106-0606	6SB-6RMP90	7250-05245	3/8	9.7	3/8-14	1.08	27.4
△ G37106-0806	8SB-6RMP90	7250-16665	1/2	12.7	3/8-14	1.08	27.4
△ G37106-0808	8SB-8RMP90	7250-16675	1/2	12.7	1/2-14	1.16	29.5
△ G37106-1006	10SB-6RMP90	7250-05255	5/8	15.9	3/8-18	1.13	28.7
△ G37106-1008	10SB-8RMP90	7250-16685	5/8	15.9	1/2-14	1.21	30.7
△ G37106-1208	12SB-8RMP90	7250-16695	3/4	19.1	1/2-14	1.28	32.5

△ WARNING: Cancer and Reproductive Harm - www.P65Warnings.ca.gov

### Male SAE 45° Flare Connector

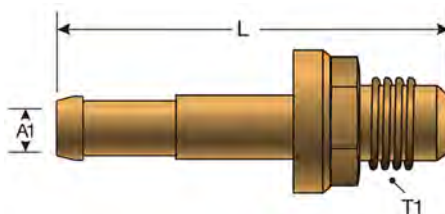

Part No.	Descr.	Prod. No.	A1		T1 (in)	L	
			"	mm		"	mm
△ G37195-0605	6SB-5RMS	7250-05265	3/8	9.7	1/2-20	2.00	50.8
△ G37195-0606	6SB-6RMS	7250-16705	3/8	9.7	3/8-18	2.00	50.8

△ WARNING: Cancer and Reproductive Harm - www.P65Warnings.ca.gov





### Male SAE Inverted Flare Swivel

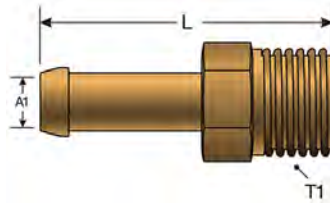

Part No.	Descr.	Prod. No.	A1		T1 (in)	L	
			"	mm		"	mm
△ G37500-0404	4SB-4RMIX	7250-16715	1/4	6.4	7/16-24	1.72	43.7
△ G37500-0405	4SB-5RMIX	7250-16725	1/4	6.4	1/2-20	1.78	45.2
△ G37500-0504	5SB-4RMIX	7250-05275	5/16	7.9	7/16-24	1.58	40.1
△ G37500-0505	5SB-5RMIX	7250-05285	5/16	7.9	1/2-20	1.58	40.1
△ G37500-0506	5SB-6RMIX	7250-05295	5/16	7.9	5/8-18	1.63	41.4
△ G37500-0605	6SB-5RMIX	7250-05305	3/8	9.7	1/2-20	1.73	44.0
△ G37500-0606	6SB-6RMIX	7250-05315	3/8	9.7	5/8-18	2.00	50.8

⚠ WARNING: Cancer and Reproductive Harm - www.P65Warnings.ca.gov

### Male SAE Inverted Flare Swivel - 45°

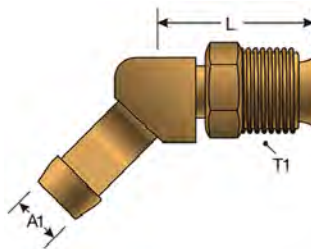

Part No.	Descr.	Prod. No.	A1		T1 (in)	L	
			"	mm		"	mm
△ G37503-0605	6SB-5RMIX45	7250-05325	3/8	9.7	1/2-20	1.25	31.8

⚠ WARNING: Cancer and Reproductive Harm - www.P65Warnings.ca.gov

- EQUIPMENT
- HOSE/CPLG. SELECTION
- G8K COUPLINGS
- GLOBALSPIRAL COUPLINGS
- STAINLESS STEEL SPIRAL
- MEGACRIMP COUPLINGS
- STAINLESS STEEL BRAID
- POWER CRIMP COUPLINGS
- FIELD ATTACHABLE G1 & G2 COUPLINGS
- FIELD ATTACHABLE C5 COUPLINGS
- C14 COUPLINGS
- GL COUPLINGS
- GLX COUPLINGS
- PCTS THERMOPLASTIC COUPLINGS
- POLARSEAL COUPLINGS (ACA)
- POLARSEAL II COUPLINGS (ACC)
- POLARSEAL II COUPLINGS (ACB)
- POWER STEERING
- ADAPTERS
- QUICK DISCONNECT COUPLERS
- BALL VALVES
- LIVE SWIVEL
- ASSEMBLY FABRICATION
- ACCESSORIES
- EQUIPMENT AND PARTS
- KITS
- AIR BRAKE HOSE ASSY
- BRASS



EQUIPMENT
HOSE/CPLG. SELECTION
G8K COUPLINGS
GLOBAL SPIRAL COUPLINGS
STAINLESS STEEL SPIRAL
MEGACRIMP COUPLINGS
STAINLESS STEEL BRAID
POWER CRIMP COUPLINGS
FIELD ATTACHABLE G1 & G2 COUPLINGS
FIELD ATTACHABLE C5 COUPLINGS
C14 COUPLINGS
GL COUPLINGS
GLX COUPLINGS
PCTS THERMOPLASTIC COUPLINGS
POLARSEAL COUPLINGS (ACA)
POLARSEAL II COUPLINGS (ACC)
POLARSEAL II COUPLINGS (ACB)
POWER STEERING
ADAPTERS
QUICK DISCONNECT COUPLERS
BALL VALVES
LIVE SWIVEL
ASSEMBLY FABRICATION
ACCESSORIES
EQUIPMENT AND PARTS
KITS
AIR BRAKE HOSE ASSY
BRASS

### Male SAE Inverted Flare Swivel - 90°

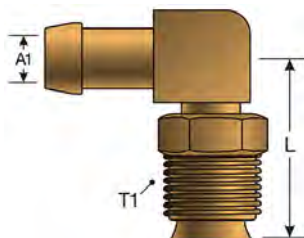

Part No.	Descr.	Prod. No.	A1		T1 (in)	L	
			"	mm		"	mm
△ G37504-0404	4SB-4RMIX90	7250-05345	1/4	6.4	7/16-24	1.01	25.7
△ G37504-0405	4SB-5RMIX90	7250-05355	1/4	6.4	1/2-20	1.01	25.7
△ G37504-0506	5SB-6RMIX90	7250-05365	5/16	7.9	5/8-18	1.21	30.7
△ G37504-0605	6SB-5RMIX90	7250-05375	3/8	9.7	1/2-20	1.21	30.7
△ G37504-0606	6SB-6RMIX90	7250-05385	3/8	9.7	5/8-18	1.40	35.6

△ WARNING: Cancer and Reproductive Harm - www.P65Warnings.ca.gov

### Female SAE Inverted Flare

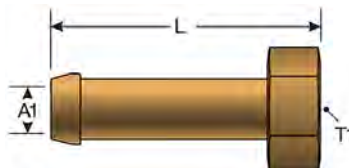

Part No.	Descr.	Prod. No.	A1		T1 (in)	L	
			"	mm		"	mm
△ G37508-0505	5SB-5RFI	7250-16735	5/16	7.9	1/2-20	2.03	51.6
△ G37508-0605	6SB-5RFI	7250-16745	3/8	9.7	1/2-20	2.09	53.1
△ G37508-0606	6SB-6RFI	7250-16755	3/8	9.7	5/8-18	2.16	54.9

△ WARNING: Cancer and Reproductive Harm - www.P65Warnings.ca.gov



**Recommended For:** Low pressure fuel, oil, compressed air, water and cooling lines. Typically used in heavy-duty truck, construction, industrial and mobile applications.

**Used With:** Low pressure multi-purpose or general purpose rubber hose and thermoplastic tubing.

**Features and Benefits:** Field attachable and reusable. An economical choice for general purpose fluid and pneumatic applications. The one-piece fitting is compact and great for use in tight spaces.

**Conformance:** Contact Gates to verify compliance to desired specifications and suitability for particular applications.

**Working Pressure:** 150 psi (10 bar)

**Temperature Range:** -40°F to +160°F (-40°C to +71°C)

**Material:** 360 Brass

### Assembly Instructions:

1. Cut hose as straight as is possible.
2. Slide clamp on hose, then lubricate hose.
3. Push hose on fitting until hose bottoms against hex or stop ring.
4. Position hose clamp between fitting end and end of hose. Tighten the clamp.
5. Hose clamps are recommended when using a barbed stem.

EQUIPMENT
HOSE/CPLG. SELECTION
G8K COUPLINGS
GLOBALSPIRAL COUPLINGS
STAINLESS STEEL SPIRAL
MEGACRIMP COUPLINGS
STAINLESS STEEL BRAID
POWER CRIMP COUPLINGS
FIELD ATTACHABLE G1 & G2 COUPLINGS
FIELD ATTACHABLE C5 COUPLINGS
C14 COUPLINGS
GL COUPLINGS
GLX COUPLINGS
PCTS THERMOPLASTIC COUPLINGS
POLARSEAL COUPLINGS (ACA)
POLARSEAL II COUPLINGS (ACC)
POLARSEAL II COUPLINGS (ACB)
POWER STEERING
ADAPTERS
QUICK DISCONNECT COUPLERS
BALL VALVES
LIVE SWIVEL
ASSEMBLY FABRICATION
ACCESSORIES
EQUIPMENT AND PARTS
KITS
AIR BRAKE HOSE ASSY
BRASS



### Male Pipe NPTF with Cone Seat

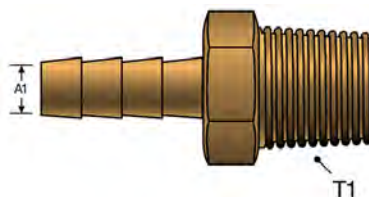

	Part No.	Descr.	Prod. No.	A1	
				"	T1 (in)
EQUIPMENT	△ G38100-0202	2BS-2MP	7250-05395	1/8	1/8-27
	△ G38100-0302	3BS-2MP	7250-05405	3/16	1/8-27
	△ G38100-0304	3BS-4MP	7250-05415	3/16	1/4-18
HOSE/CPLG. SELECTION	△ G38100-0402	4BS-2MP	7250-05425	1/4	1/8-27
	△ G38100-0404	4BS-4MP	7250-05435	1/4	1/4-18
G8K COUPLINGS	△ G38100-0406	4BS-6MP	7250-05445	1/4	3/8-18
	△ G38100-0502	5BS-2MP	7250-05455	5/16	1/8-27
	△ G38100-0504	5BS-4MP	7250-05465	5/16	1/4-18
GLOBAL SPIRAL COUPLINGS	△ G38100-0602	6BS-2MP	7250-05475	3/8	1/8-27
	△ G38100-0604	6BS-4MP	7250-05485	3/8	1/4-18
STAINLESS STEEL SPIRAL	△ G38100-0606	6BS-6MP	7250-05495	3/8	3/8-18
	△ G38100-0608	6BS-8MP	7250-05505	3/8	1/2-14
	△ G38100-0804	8BS-4MP	7250-05515	1/2	1/4-18
MEGACRIMP COUPLINGS	△ G38100-0806	8BS-6MP	7250-05525	1/2	3/8-18
	△ G38100-0808	8BS-8MP	7250-05535	1/2	1/2-14
	△ G38100-0812	8BS-12MP	7250-05545	1/2	3/4-14
STAINLESS STEEL BRAID	△ G38100-1006	10BS-6MP	7250-05555	5/8	3/8-18
	△ G38100-1008	10BS-8MP	7250-05565	5/8	1/2-14
POWER CRIMP COUPLINGS	△ G38100-1012	10BS-12MP	7250-05575	5/8	3/4-14
	△ G38100-1208	12BS-8MP	7250-05585	3/4	1/2-14
	△ G38100-1212	12BS-12MP	7250-05595	3/4	3/4-14

△ WARNING: Cancer and Reproductive Harm - www.P65Warnings.ca.gov

### Female Pipe NPTF



	Part No.	Descr.	Prod. No.	A1	
				"	T1 (in)
BALL VALVES	△ G38110-0202	2BS-2FP	7250-05605	1/8	1/8-27
	△ G38110-0302	3BS-2FP	7250-05615	3/16	1/8-27
	△ G38110-0402	4BS-2FP	7250-05625	1/4	1/8-27
LIVE SWIVEL	△ G38110-0404	4BS-4FP	7250-05635	1/4	1/4-18
	△ G38110-0502	5BS-2FP	7250-05645	5/16	1/8-27
ASSEMBLY FABRICATION	△ G38110-0504	5BS-4FP	7250-05655	5/16	1/4-18
	△ G38110-0602	6BS-2FP	7250-05665	3/8	1/8-27
	△ G38110-0604	6BS-4FP	7250-05675	3/8	1/4-18
ACCESSORIES	△ G38110-0606	6BS-6FP	7250-05685	3/8	3/8-18
	△ G38110-0804	8BS-4FP	7250-05695	1/2	1/4-18
	△ G38110-0806	8BS-6FP	7250-05705	1/2	3/8-18

△ WARNING: Cancer and Reproductive Harm - www.P65Warnings.ca.gov

EQUIPMENT
HOSE/CPLG. SELECTION
G8K COUPLINGS
GLOBAL SPIRAL COUPLINGS
STAINLESS STEEL SPIRAL
MEGACRIMP COUPLINGS
STAINLESS STEEL BRAID
POWER CRIMP COUPLINGS
FIELD ATTACHABLE G1 & G2 COUPLINGS
FIELD ATTACHABLE C5 COUPLINGS
C14 COUPLINGS
GL COUPLINGS
GLX COUPLINGS
PCTS THERMOPLASTIC COUPLINGS
POLARSEAL COUPLINGS (ACA)
POLARSEAL II COUPLINGS (ACC)
POLARSEAL II COUPLINGS (ACB)
POWER STEERING
ADAPTERS
QUICK DISCONNECT COUPLERS
BALL VALVES
LIVE SWIVEL
ASSEMBLY FABRICATION
ACCESSORIES
EQUIPMENT AND PARTS
KITS
AIR BRAKE HOSE ASSY
BRASS



Female Pipe NPTF - Continued

Part No.	Descr.	Prod. No.	A1	
			"	T1 (in)
△ G38110-0808	8BS-8FP	7250-05715	1/2	1/2-14

△ WARNING: Cancer and Reproductive Harm - www.P65Warnings.ca.gov

- EQUIPMENT
- HOSE/CPLG. SELECTION
- G8K COUPLINGS
- GLOBALSPIRAL COUPLINGS
- STAINLESS STEEL SPIRAL
- MEGACRIMP COUPLINGS
- STAINLESS STEEL BRAID
- POWER CRIMP COUPLINGS
- FIELD ATTACHABLE G1 & G2 COUPLINGS
- FIELD ATTACHABLE C5 COUPLINGS
- C14 COUPLINGS
- GL COUPLINGS
- GLX COUPLINGS
- PCTS THERMOPLASTIC COUPLINGS
- POLARSEAL COUPLINGS (ACA)
- POLARSEAL II COUPLINGS (ACC)
- POLARSEAL II COUPLINGS (ACB)
- POWER STEERING
- ADAPTERS
- QUICK DISCONNECT COUPLERS
- BALL VALVES
- LIVE SWIVEL
- ASSEMBLY FABRICATION
- ACCESSORIES
- EQUIPMENT AND PARTS
- KITS
- AIR BRAKE HOSE ASSY
- BRASS



**NOTES**

EQUIPMENT
HOSE/CPLG. SELECTION
G8K COUPLINGS
GLOBAL SPIRAL COUPLINGS
STAINLESS STEEL SPIRAL
MEGACRIMP COUPLINGS
STAINLESS STEEL BRAID
POWER CRIMP COUPLINGS
FIELD ATTACHABLE G1 & G2 COUPLINGS
FIELD ATTACHABLE C5 COUPLINGS
C14 COUPLINGS
GL COUPLINGS
GLX COUPLINGS
PCTS THERMOPLASTIC COUPLINGS
POLARSEAL COUPLINGS (ACA)
POLARSEAL II COUPLINGS (ACC)
POLARSEAL II COUPLINGS (ACB)
POWER STEERING
ADAPTERS
QUICK DISCONNECT COUPLERS
BALL VALVES
LIVE SWIVEL
ASSEMBLY FABRICATION
ACCESSORIES
EQUIPMENT AND PARTS
KITS
AIR BRAKE HOSE ASSY
BRASS



Category	Page	Category	Page
<b>Hydraulic Hose</b>		<b>Hydraulic Hose (Continued)</b>	
G8K Spiral Wire Hose	A19	C5D High-Temp Multi-Fluid Hose	A79
EFG6K Spiral Wire Hose - SAE 100R15	A19	C5M Marine Fuel Line Hose	A80
EFG6K Spiral Wire Hose - SAE 100R15 - MegaTuff® Cover	A21	C5E High-Temp Flexline Hose	A80
EFG6KL Low Temp Spiral Wire Hose	A22	C14 PTFE Hose - SAE 100R14 Type A - Nonconductive	A81
EFG5K Spiral Wire Hose - SAE 100R13	A22	C14CT PTFE Hose - SAE 100R14 Type B - Conductive	A82
EFG5K Spiral Wire Hose - SAE 100R13 - MegaTuff® Cover	A24	PolarSeal® Hose	A83
EFG5K Spiral Wire Hose - SAE 100R13 - XtraTuff® Cover	A25	PolarSeal® II Hose	A83
EFG5KL Low Temp Spiral Wire Hose	A25	PS188 Power Steering Hose	A84
ID5K Spiral Wire Hose - ISO 18752 Grade D	A26	J2AT 2-Wire Braid Jack Hose - 10,000 Static Pressure Only	A85
EFG4K Spiral Wire Hose - SAE 100R12	A27	J2AT 2-Wire Braid Jack Hose - MegaTuff® Cover - 10,000 Static Pressure Only	A85
EFG4K Spiral Wire Hose - SAE 100R12 - MegaTuff® Cover	A28	Hot Oiler 2-Wire Braid Hose	A86
EFG4K Spiral Wire Hose - SAE 100R12 - XtraTuff® Cover	A29	Hot Oiler 2-Wire Braid Hose - MegaTuff® Cover	A86
EFG4KL Low Temp Spiral Wire Hose	A30	RFS Red Fire Suppressant Hose	A87
EFG3K Spiral Wire Hose - SAE 100R12	A30	Plant Master® 150-200	A87
EFG3K Spiral Wire Hose - SAE 100R12 - MegaTuff® Cover	A31	Plant Master® 250	A89
Global M6K Mega6000™ Hose	A32	Plant Master® 300	A90
Global M5K Mega5000™ Hose	A32	Plant Master® XTreme® 501 AR	A91
Global M5K Mega5000™ Hose - MegaTuff® Cover	A33	Plant Master® Plus	A91
Global M5K Mega5000™ Hose - XtraTuff® Cover	A33	Plant Master® XTreme®	A93
Global M4K Mega4000™ Hose - SAE 100R19	A34	Plant Master® XTreme® 300 AR	A94
Global M4K Mega4000™ Hose - SAE 100R19 - MegaTuff® Cover	A35	Plant Master® Plus Lock-On	A95
Global M4K Mega4000™ Hose - SAE 100R19 - XtraTuff® Cover	A36	Ag Master®	A96
Global M4KH Mega4000™ Hose - High-Temp - SAE 100R19	A37	Clean Master® Pressure Wash	A96
Global M4KH Mega4000™ Hose - High-Temp - SAE 100R19 - MegaTuff® Cover	A38	Clean Master® Pressure Wash Assemblies	A97
Global M4KL Mega4000™ PolarFlex® Hose - SAE 100R19	A39	LP350X Hose	A98
Global M3K Mega3000™ Hose - SAE 100R17	A39	LP350 Hose	A98
Global M3K Mega3000™ Hose - SAE 100R17 - MegaTuff® Cover	A41	Fuel Master® Delivery	A99
Global M3K Mega3000™ Hose - SAE 100R17 - XtraTuff® Cover	A42	LPG Vapor	A100
Global M3KH Mega3000™ Hose - High-Temp - SAE 100R17	A43	Fuel Master® Curb Pump	A100
Global M3KH Mega3000™ Hose - High-Temp - SAE 100R17 - MegaTuff® Cover	A43	Fuel Master® Diesel Curb Pump	A101
MXT™ MegaSys® Wire Braid Hose - SAE 100R16	A44	<b>Equipment</b>	
M2T® MegaFlex® 2-Wire Braid Hose - SAE 100R16	A45	Equipment	B1
M2T® MegaFlex® 2-Wire Braid Hose - SAE 100R16 - MegaTuff® Cover	A46	<b>Hose/Cplg. Selection</b>	
M2T® MegaFlex® 2-Wire Braid Hose - SAE 100R16 - XtraTuff® Cover	A47	Hose/Cplg. Selection	C1
CM2TDL MegaFlex® Connected Dual-Line 2-Wire Braid - SAE 100R16 - XtraTuff® Cover	A48	<b>G8K Couplings</b>	
Global G2 2-Wire Braid Hose - SAE 100R2 Type AT	A48	Caterpillar Style O-Ring Flange	D2
Global G2H High-Temp 2-Wire Braid Hose - SAE 100R2 Type AT	A49	12G8K-12FLC	D2
Global G2H High-Temp 2-Wire Braid Hose - SAE 100R2 Type AT	A50	16G8K-16FLC	D2
Global G2XH 2-Wire Braid XTreme® Heat Hose - SAE 100R2 Type AT	A50	Caterpillar Style O-Ring Flange - 45° Bent Tube	D2
Global G2L PolarFlex® Hose - SAE 100R2 Type AT	A51	12G8K-12FLC45-034	D2
M-XP™ Million Impulse Xtra Performance Wire Braid Hose	A52	16G8K-16FLC45-050	D2
Global G1 1-Wire Braid Hose - SAE 100R1 Type AT	A52	Caterpillar Style O-Ring Flange - 90° Bent Tube	D3
Global G1H 1-Wire Braid Hose - High-Temp - SAE 100R1 Type AT	A53	12G8K-12FLC90-070	D3
TH7 Hydraulic Hose - SAE 100R7	A54	16G8K-16FLC90-093	D3
TH7NC Non Conductive Hydraulic Hose - SAE 100R7	A55	16G8K-16FLC90-117	D3
TH7DL Dual Line Hydraulic Hose - SAE 100R7	A56	G8K Ferrule for G8K Spiral Hose	D3
TH7NCDL Non Conductive Dual Line Hydraulic Hose - SAE 100R7	A56	12G8K1F	D3
TH7S Hydraulic Hose - SAE 100R7	A57	16G8K1F	D3
TH7SNC Non Conductive Hydraulic Hose - SAE 100R7	A58	<b>GlobalSpiral™ Couplings</b>	
TH8 Hydraulic Hose - SAE 100R8	A58	Male Pipe (NPTF - 30° Cone Seat)	E4
TH8NC Non Conductive Hydraulic Hose - SAE 100R8	A59	6GS-6MP	E4
TH18 Constant Pressure Hydraulic Hose - SAE 100R18	A59	6GS-8MP	E4
TH18NC Constant Pressure Non Conductive Hydraulic Hose - SAE 100R18	A60	8GS-8MP	E4
G3H High-Temp 2-Fiber Braid Hose - SAE 100R3	A61	8GS-12MP	E4
GTH High-Temp 1-Fiber Braid Hose - SAE 100R6	A61	10GS-8MP	E4
GTHX High-Temp Fiber Spiral Hose - SAE 100R6	A62	10GS-12MP	E4
M500 Wire Braid Hose	A63	12GS-8MP	E4
M500 Wire Braid Hose - MegaTuff® Cover	A63	12GS-12MP	E4
M500 Wire Braid Hose - XtraTuff® Cover	A64	12GS-16MP	E4
Multi Master® GMV™ MegaFlex® Return Line and Suction Hose - SAE 100R4	A64	16GS-12MP	E4
GMV Global MegaVac® Return Line and Suction Hose - SAE 100R4	A65	16GS-16MP	E4
RLA 1-Fiber Braid Return Line and Low Pressure Hose	A66	16GS-20MP	E4
RLC 3-Fiber Braid Return Line and Low Pressure Hose	A67	20GS-20MP	E4
MegaTech® LOC 1-Fiber Braid High-Temp Lock-On Hose	A67	API Line Pipe Connection	E4
LOC 1-Fiber Braid Lock-On Hose	A68	20GS-20API-LP	E4
LOL Plus Lock-On Hose	A69	Male Pipe (NPTF - 30° Cone Seat) - Long Hex	E5
AB Series Air Brake Hose	A70	16GS-16MPLH	E5
Heavy-Duty Green Stripe® Air Brake Hose	A71	Male O-Ring Boss	E5
Green Stripe® Vacuum Brake Hose	A71	6GS-6MB	E5
TR500 High-Temp/Air Brake/Engine Hose	A72	8GS-8MB	E5
MegaTech® G5TB Oil-Air Return	A72		
MegaTech® II - SAE 100R2 Type AT - ACP	A73		
MegaTech® 3000 High-Temp Oil-Air Return	A74		
MegaTech® 1000 High-Temp Oil-Air Return	A74		
MegaTech® 500 High-Temp Oil-Air Return	A75		
MegaTech® 250 High-Temp Transmission Oil Cooler (TOC) Hose	A76		
C5C Hydraulic Hose - SAE 100R5	A77		
C5C-XH XTreme® Heat Hose - SAE 100R5	A78		



Category Page  
**GlobalSpiral™ Couplings (Continued)**

Male O-Ring Boss (Continued)  
 8GS-10MB  
 10GS-10MB  
 10GS-12MB  
 12GS-12MB  
 12GS-16MB  
 16GS-12MB  
 16GS-16MB  
 16GS-20MB  
 20GS-20MB

Female MegaSeal® Swivel  
 12GS-12FMX  
 12GS-16FMX  
 16GS-16FMX  
 20GS-20FMX

Female MegaSeal® Swivel - 45° Bent Tube  
 12GS-12FMX45-032  
 16GS-16FMX45-038  
 20GS-20FMX45-041

Female MegaSeal® Swivel - 90° Bent Tube  
 12GS-12FMX90-048  
 12GS-12FMX90-058  
 12GS-12FMX90-096  
 12GS-16FMX90-056  
 16GS-16FMX90-056  
 16GS-16FMX90-071

Male JIC 37° Flare  
 6GS-6MJ  
 6GS-8MJ  
 6GS-10MJ  
 8GS-8MJ  
 8GS-10MJ  
 10GS-10MJ  
 10GS-12MJ  
 12GS-12MJ  
 12GS-14MJ  
 12GS-16MJ  
 16GS-16MJ  
 16GS-20MJ  
 20GS-20MJ

Female JIC 37° Flare Swivel  
 6GS-6FJX  
 6GS-8FJX  
 8GS-8FJX  
 8GS-10FJX  
 8GS-12FJX  
 10GS-10FJXMM  
 10GS-12FJX  
 12GS-10FJX  
 12GS-12FJX  
 12GS-14FJX  
 12GS-16FJX  
 16GS-12FJX  
 16GS-14FJX  
 16GS-16FJX  
 16GS-20FJX  
 20GS-16FJX  
 20GS-20FJX  
 20GS-24FJX

Female JIC 37° Flare Swivel - 30° Bent Tube  
 16GS-16FJX30M

Female JIC 37° Flare Swivel - 45° Bent Tube  
 6GS-6FJX45S  
 6GS-8FJX45S  
 8GS-8FJX45S  
 8GS-10FJX45S  
 10GS-10FJXMM45-018  
 10GS-12FJX45S  
 12GS-12FJX45S  
 12GS-16FJX45S  
 16GS-16FJX45S  
 16GS-16FJX45M  
 16GS-20FJX45S  
 20GS-20FJX45-038

Female JIC 37° Flare Swivel - 60° Bent Tube  
 12GS-12FJX60-043

Category Page  
**GlobalSpiral™ Couplings (Continued)**

E5 Female JIC 37° Flare Swivel - 90° Bent Tube  
 E5 6GS-6FJX90S  
 E5 6GS-6FJXMM90M  
 E5 6GS-6FJX90L  
 E5 6GS-8FJX90M  
 E5 6GS-8FJX90-083  
 E5 8GS-8FJX90S  
 E5 8GS-8FJX90M  
 E5 8GS-8FJX90L  
 E5 8GS-8FJX90XL  
 E5 8GS-10FJX90S  
 E6 8GS-10FJX90M  
 E6 8GS-10FJX90L  
 E6 8GS-12FJX90S  
 E6 10GS-10FJXMM90-036  
 E6 10GS-10FJXMM90M  
 E6 10GS-12FJX90M  
 E6 12GS-12FJX90S  
 E6 12GS-12FJX90M  
 E6 12GS-12FJX90L  
 E7 12GS-14FJX90-060  
 E7 12GS-16FJX90S  
 E7 12GS-16FJX90M  
 E7 12GS-16FJX90L  
 E7 16GS-16FJX90S  
 E7 16GS-16FJX90M  
 E7 16GS-16FJX90L  
 E7 16GS-20FJX90L  
 E7 20GS-20FJX90S  
 E7 20GS-20FJX90M  
 E7 20GS-20FJX90L  
 E7 20GS-24FJX90M

E7 Male Flat-Face O-Ring  
 E7 6GS-6MFFOR  
 E7 8GS-8MFFOR  
 E7 8GS-10MFFOR  
 E7 10GS-10MFFOR  
 E7 10GS-12MFFOR  
 E7 12GS-12MFFOR  
 E7 12GS-16MFFOR  
 E7 16GS-16MFFOR  
 E7 16GS-20MFFOR  
 E7 20GS-20MFFOR

E8 Female Flat-Face O-Ring Swivel  
 E8 6GS-6FFORX  
 E8 6GS-8FFORX  
 E8 8GS-8FFORX  
 E8 8GS-10FFORX  
 E8 8GS-12FFORX  
 E8 10GS-10FFORX  
 E8 10GS-12FFORX  
 E8 12GS-10FFORX  
 E8 12GS-12FFORX  
 E8 12GS-16FFORX  
 E8 12GS-20FFORX  
 E8 16GS-12FFORX  
 E8 16GS-16FFORX  
 E8 16GS-20FFORX  
 E8 20GS-20FFORX  
 E8 20GS-24FFORX

E8 Female Flat-Face O-Ring Swivel - 22 1/2° Bent Tube  
 E8 16GS-16FFORX22-011

E9 Female Flat-Face O-Ring Swivel - 30° Bent Tube  
 E9 16GS-16FFORX30-14

E9 Female Flat-Face O-Ring Swivel - 45° Bent Tube  
 E9 6GS-6FFORX45S  
 E9 6GS-8FFORX45S  
 E9 8GS-8FFORX45S  
 E9 8GS-10FFORX45S  
 E9 8GS-12FFORX45S  
 E9 10GS-10FFORX45S  
 E9 12GS-12FFORX45S  
 E9 12GS-16FFORX45S  
 E9 16GS-16FFORX45S  
 E9 16GS-20FFORX45S  
 E9 20GS-20FFORX45-032

E9 Female JIC 37° Flare Swivel - 90° Bent Tube  
 E10 6GS-6FJX90S  
 E10 6GS-6FJXMM90M  
 E10 6GS-6FJX90L  
 E10 6GS-8FJX90M  
 E10 6GS-8FJX90-083  
 E10 8GS-8FJX90S  
 E10 8GS-8FJX90M  
 E10 8GS-8FJX90L  
 E10 8GS-8FJX90XL  
 E10 8GS-10FJX90S  
 E10 8GS-10FJX90M  
 E10 8GS-10FJX90L  
 E10 8GS-12FJX90S  
 E10 10GS-10FJXMM90-036  
 E10 10GS-10FJXMM90M  
 E10 10GS-12FJX90M  
 E10 12GS-12FJX90S  
 E10 12GS-12FJX90M  
 E10 12GS-12FJX90L  
 E10 12GS-14FJX90-060  
 E10 12GS-16FJX90S  
 E10 12GS-16FJX90M  
 E10 12GS-16FJX90L  
 E10 16GS-16FJX90S  
 E10 16GS-16FJX90M  
 E10 16GS-16FJX90L  
 E10 16GS-20FJX90L  
 E10 20GS-20FJX90S  
 E10 20GS-20FJX90M  
 E10 20GS-20FJX90L  
 E10 20GS-24FJX90M

E11 Male Flat-Face O-Ring  
 E11 6GS-6MFFOR  
 E11 8GS-8MFFOR  
 E11 8GS-10MFFOR  
 E11 10GS-10MFFOR  
 E11 10GS-12MFFOR  
 E11 12GS-12MFFOR  
 E11 12GS-16MFFOR  
 E11 16GS-16MFFOR  
 E11 16GS-20MFFOR  
 E11 20GS-20MFFOR

E11 Female Flat-Face O-Ring Swivel  
 E11 6GS-6FFORX  
 E11 6GS-8FFORX  
 E11 8GS-8FFORX  
 E11 8GS-10FFORX  
 E11 8GS-12FFORX  
 E11 10GS-10FFORX  
 E11 10GS-12FFORX  
 E11 12GS-10FFORX  
 E11 12GS-12FFORX  
 E11 12GS-16FFORX  
 E11 12GS-20FFORX  
 E11 16GS-12FFORX  
 E11 16GS-16FFORX  
 E11 16GS-20FFORX  
 E11 20GS-20FFORX  
 E12 20GS-24FFORX

E12 Female Flat-Face O-Ring Swivel - 22 1/2° Bent Tube  
 E12 16GS-16FFORX22-011

E12 Female Flat-Face O-Ring Swivel - 30° Bent Tube  
 E12 16GS-16FFORX30-14

E13 Female Flat-Face O-Ring Swivel - 45° Bent Tube  
 E13 6GS-6FFORX45S  
 E13 6GS-8FFORX45S  
 E13 8GS-8FFORX45S  
 E13 8GS-10FFORX45S  
 E13 8GS-12FFORX45S  
 E13 10GS-10FFORX45S  
 E13 12GS-12FFORX45S  
 E13 12GS-16FFORX45S  
 E13 16GS-16FFORX45S  
 E13 16GS-20FFORX45S  
 E13 20GS-20FFORX45-032





Category	Page	Category	Page
<b>GlobalSpiral™ Couplings (Continued)</b>		<b>GlobalSpiral™ Couplings (Continued)</b>	
Female Flat-Face O-Ring Swivel - 90° Bent Tube	E13	Code 61 O-Ring Flange - 45° Bent Tube	E17
6GS-6FFORX90S	E13	6GS-8FL45M	E17
6GS-6FFORX90L	E13	8GS-8FL45M	E17
6GS-8FFORX90M	E13	8GS-12FL45M	E17
8GS-8FFORX90S	E13	10GS-12FL45M	E17
8GS-8FFORX90M	E13	12GS-12FL45M	E17
8GS-8FFORX90-083	E13	12GS-16FL45S	E17
8GS-10FFORX90S	E13	16GS-16FL45M	E17
8GS-10FFORX90M	E13	16GS-20FL45M	E17
8GS-10FFORX90L	E13	20GS-16FL45M	E17
8GS-12FFORX90S	E13	20GS-20FL45S	E17
10GS-10FFORX90S	E13	20GS-24FL45S	E17
10GS-10FFORX90M	E13	Code 61 Komatsu Style O-Ring Flange - 45° Bent Tube	E18
10GS-10FFORX90L	E13	10GS-10FLK45-026	E18
10GS-12FFORX90S	E14	Code 61 O-Ring Flange - 60° Bent Tube	E18
12GS-10FFORX90S	E14	8GS-8FL60M	E18
12GS-12FFORX90S	E14	12GS-12FL60M	E18
12GS-12FFORX90M	E14	12GS-16FL60M	E18
12GS-12FFORX90L	E14	16GS-16FL60M	E18
12GS-16FFORX90S	E14	16GS-20FL60M	E18
12GS-16FFORX90M	E14	20GS-20FL60M	E18
12GS-16FFORX90L	E14	20GS-24FL60M	E18
16GS-16FFORX90S	E14	Code 61 O-Ring Flange - 67 1/2° Bent Tube	E19
16GS-16FFORX90M	E14	8GS-12FL67-032	E19
16GS-16FFORX90L	E14	12GS-12FL67M	E19
16GS-20FFORX90S	E14	12GS-16FL67M	E19
16GS-20FFORX90M	E14	16GS-16FL67M	E19
16GS-20FFORX90L	E14	16GS-20FL67M	E19
20GS-20FFORX90S	E14	20GS-20FL67M	E19
20GS-20FFORX90M	E14	20GS-24FL67S	E19
20GS-20FFORX90L	E14	Code 61 O-Ring Flange - 90° Bent Tube	E19
20GS-24FFORX90-064	E14	6GS-8FL90M	E19
Female Flat-Face O-Ring Swivel - 135° Bent Tube	E14	8GS-8FL90M	E19
12GS-16FFORX135	E14	8GS-8FL90L	E19
Code 61 O-Ring Flange	E15	8GS-12FL90M	E19
6GS-8FL	E15	10GS-12FL90M	E19
8GS-8FL	E15	12GS-8FL90-050	E19
8GS-12FL	E15	12GS-12FL90M	E19
8GS-16FL	E15	12GS-12FL90-100	E19
10GS-12FL	E15	12GS-12FL90-125	E20
12GS-8FL	E15	12GS-16FL90S	E20
12GS-12FL	E15	12GS-16FL90M	E20
12GS-16FL	E15	12GS-16FL90-080	E20
12GS-20FL	E15	12GS-16FL90-178	E20
16GS-12FL	E15	12GS-20FL90-054	E20
16GS-16FL	E15	12GS-20FL90-125	E20
16GS-20FL	E15	16GS-12FL90M	E20
16GS-24FL	E15	16GS-12FL90	E20
20GS-16FL	E15	16GS-16FL90S	E20
20GS-20FL	E15	16GS-16FL90M	E20
20GS-24FL	E15	16GS-16FL90-120	E20
20GS-32FL	E15	16GS-16FL90-150	E20
Code 61 Komatsu Style O-Ring Flange	E15	16GS-16FL90-210	E20
8GS-10FLK	E15	16GS-20FL90S	E20
10GS-10FLK	E15	16GS-20FL90M	E20
12GS-10FLK	E15	16GS-20FL90-120	E20
Code 61 O-Ring Flange Long Neck	E16	16GS-24FL90-060	E20
12GS-12FLL	E16	16GS-24FL90S	E20
16GS-16FLL	E16	20GS-16FL90M	E20
20GS-20FLL	E16	20GS-16FL90-215	E20
Code 61 O-Ring Flange - 22 1/2° Bent Tube	E16	20GS-20FL90S	E20
8GS-8FL22M	E16	20GS-20FL90M	E20
12GS-12FL22M	E16	20GS-20FL90-168	E20
12GS-16FL22M	E16	20GS-24FL90S	E20
16GS-16FL22M	E16	20GS-24FL90-118	E20
16GS-20FL22M	E16	Code 61 Komatsu Style O-Ring Flange - 90° Bent Tube	E20
20GS-20FL22M	E16	10GS-10FLK90-055	E20
20GS-24FL22M	E16	12GS-10FLK90-055	E20
Code 61 O-Ring Flange - 30° Bent Tube	E17	Code 61 O-Ring Flange - 100° Bent Tube	E21
8GS-12FL30M	E17	12GS-16FL100-059	E21
12GS-12FL30M	E17	Code 61 O-Ring Flange - 110° Bent Tube	E21
12GS-16FL30M	E17	12GS-12FL110-064	E21
16GS-16FL30M	E17	16GS-16FL110-073	E21
16GS-20FL30M	E17	16GS-20FL110-073	E21
20GS-20FL30M	E17	20GS-20FL110-080	E21
20GS-24FL30M	E17	20GS-24FL110-080	E21



Category	Page	Category	Page
<b>GlobalSpiral™ Couplings (Continued)</b>		<b>GlobalSpiral™ Couplings (Continued)</b>	
Code 61 O-Ring Flange - 135° Bent Tube	E22	Code 62 O-Ring Flange Heavy - 90° Bent Tube (Continued)	E26
12GS-12FL135-070	E22	20GS-20FLH90-152	E26
Code 62 O-Ring Flange Heavy	E22	20GS-24FLH90S	E26
8GS-8FLH	E22	Code 62 O-Ring Flange Heavy - 110° Bent Tube	E26
8GS-12FLH	E22	12GS-12FLH110-064	E26
10GS-8FLH	E22	Caterpillar Style O-Ring Flange	E27
10GS-12FLH	E22	12GS-12FLC	E27
12GS-12FLH	E22	12GS-16FLC	E27
12GS-16FLH	E22	16GS-16FLC	E27
16GS-12FLH	E22	16GS-20FLC	E27
16GS-16FLH	E22	20GS-20FLC	E27
16GS-20FLH	E22	20GS-24FLC	E27
20GS-16FLH	E22	Caterpillar Style O-Ring Flange - 22 1/2° Bent Tube	E27
20GS-20FLH	E22	12GS-12FLC22-016	E27
20GS-24FLH	E22	16GS-16FLC22-017	E27
Code 62 O-Ring Flange Heavy - 22 1/2° Bent Tube	E23	16GS-20FLC22-017	E27
12GS-16FLH22M	E23	20GS-20FLC22-017	E27
16GS-16FLH22M	E23	20GS-24FLC22-017	E27
16GS-20FLH22M	E23	Caterpillar Style O-Ring Flange - 30° Bent Tube	E28
20GS-20FLH22M	E23	12GS-12FLC30-022	E28
20GS-24FLH22M	E23	12GS-16FLC30-022	E28
Code 62 O-Ring Flange Heavy - 30° Bent Tube	E23	16GS-16FLC30-023	E28
12GS-12FLH30M	E23	16GS-20FLC30-023	E28
12GS-16FLH30M	E23	20GS-20FLC30-024	E28
16GS-16FLH30M	E23	20GS-24FLC30-024	E28
16GS-20FLH30M	E23	Caterpillar Style O-Ring Flange - 45° Bent Tube	E28
20GS-20FLH30M	E23	12GS-12FLC45-035	E28
20GS-24FLH30M	E23	12GS-12FLC45-066	E28
Code 62 O-Ring Flange Heavy - 45° Bent Tube	E24	12GS-16FLC45-035	E28
8GS-8FLH45M	E24	16GS-16FLC45-037	E28
8GS-12FLH45M	E24	16GS-20FLC45-037	E28
10GS-12FLH45M	E24	20GS-20FLC45-037	E28
12GS-8FLH45M	E24	20GS-24FLC45-037	E28
12GS-12FLH45M	E24	Caterpillar Style O-Ring Flange - 60° Bent Tube	E29
12GS-16FLH45M	E24	12GS-16FLC60-048	E29
16GS-12FLH45M	E24	16GS-16FLC60-050	E29
16GS-16FLH45M	E24	16GS-20FLC60-050	E29
16GS-20FLH45M	E24	20GS-20FLC60-052	E29
20GS-16FLH45M	E24	20GS-24FLC60-052	E29
20GS-20FLH45M	E24	Caterpillar Style O-Ring Flange - 67 1/2° Bent Tube	E29
20GS-24FLH45M	E24	16GS-16FLC67-057	E29
Code 62 O-Ring Flange Heavy - 60° Bent Tube	E24	16GS-20FLC67-057	E29
12GS-12FLH60M	E24	20GS-20FLC67-059	E29
12GS-16FLH60M	E24	20GS-24FLC67-059	E29
16GS-16FLH60M	E24	Caterpillar Style O-Ring Flange - 90° Bent Tube	E30
20GS-20FLH60M	E24	12GS-12FLC90-068	E30
20GS-24FLH60M	E24	12GS-12FLC90-128	E30
Code 62 O-Ring Flange Heavy - 67 1/2° Bent Tube	E25	12GS-16FLC90-068	E30
16GS-16FLH67M	E25	16GS-16FLC90-074	E30
Code 62 O-Ring Flange Heavy - 90° Bent Tube	E25	16GS-16FLC90-132	E30
8GS-8FLH90M	E25	16GS-20FLC90-074	E30
8GS-8FLH90-080	E25	16GS-20FLC90-132	E30
8GS-12FLH90M	E25	20GS-20FLC90-077	E30
10GS-8FLH90M	E25	20GS-20FLC90-150	E30
10GS-12FLH90M	E25	20GS-24FLC90-077	E30
12GS-12FLH90M	E25	20GS-24FLC90-150	E30
12GS-12FLH90-100	E25	Female French GAZ (Poclair) 24° High Pressure Flange	E30
12GS-12FLH90-122	E25	8GS-17FPFL	E30
12GS-16FLH90S	E25	10GS-21FPFL	E30
12GS-16FLH90M	E25	12GS-27FPFL	E30
12GS-16FLH90-140	E25	16GS-34FPFL	E30
12GS-20FLH90M	E25	20GS-42FPFL	E30
16GS-12FLH90M	E25	Male French GAZ (Poclair) 24° High Pressure Flange	E31
16GS-16FLH90S	E25	8GS-17MPFL	E31
16GS-16FLH90M	E26	10GS-21MPFL	E31
16GS-16FLH90-120	E26	12GS-27MPFL	E31
16GS-16FLH90-090	E26	16GS-34MPFL	E31
16GS-20FLH90S	E26	20GS-42MPFL	E31
16GS-20FLH90M	E26	Male French GAZ (Poclair) 24° High Pressure Flange - 90° Bent Tube	E31
16GS-24FLH90S	E26	10GS-21MPFL90	E31
20GS-16FLH90S	E26	20GS-42MPFL90	E31
20GS-16FLH90M	E26	Hose Length Extender Caterpillar	E31
20GS-16FLH90-100	E26	12GS-12HLEC	E31
20GS-20FLH90-076	E26	16GS-16HLEC	E31
20GS-20FLH90M	E26		
20GS-20FLH90-120	E26		



Category	Page	Category	Page
<b>GlobalSpiral™ Couplings (Continued)</b>		<b>GlobalSpiral™ Couplings (Continued)</b>	
Hose Length Extender	E32	Female DIN 24° Cone Swivel - Heavy Series with O-Ring (Continued)	E37
8GS-8HLE	E32	12GS-20FDHORX	E37
12GS-12HLE	E32	12GS-25FDHORX	E37
16GS-16HLE	E32	16GS-25FDHORX	E37
20GS-20HLE	E32	16GS-30FDHORX	E37
Hose Length Extender - 45° Bent Tube	E32	16GS-38FDHORX	E37
20GS-20HLE45-103	E32	20GS-38FDHORX	E37
Hose Length Extender - 90° Bent Tube	E33	Female DIN 24° Cone Swivel - Heavy Series with O-Ring - 45° Bent Tube	E38
8GS-8HLE90-086	E33	6GS-12FDHORX45	E38
12GS-12HLE90	E33	6GS-14FDHORX45	E38
16GS-16HLE90-127	E33	8GS-16FDHORX45	E38
20GS-20HLE90-155	E33	10GS-20FDHORX45	E38
Male DIN 24° Cone - Light Series	E33	12GS-20FDHORX45	E38
6GS-12MDL	E33	12GS-25FDHORX45M	E38
8GS-15MDL	E33	16GS-25FDHORX45M	E38
12GS-22MDL	E33	16GS-30FDHORX45	E38
16GS-28MDL	E33	20GS-38FDHORX45M	E38
Female DIN 24° Cone Swivel - Light Series with O-Ring	E34	Female DIN 24° Cone Swivel - Heavy Series with O-Ring - 90° Bent Tube	E38
6GS-12FDLORX	E34	6GS-12FDHORX90	E38
8GS-15FDLORX	E34	6GS-14FDHORX90	E38
10GS-18FDLORX	E34	8GS-16FDHORX90M	E38
12GS-22FDLORX	E34	10GS-20FDHORX90M	E38
12GS-28FDLORX	E34	12GS-20FDHORX90	E38
16GS-28FDLORX	E34	12GS-25FDHORX90M	E38
20GS-35FDLORX	E34	16GS-25FDHORX90	E38
Female DIN 24° Cone Swivel - Light Series with O-Ring - 45° Bent Tube	E34	16GS-30FDHORX90M	E38
8GS-15FDLORX45	E34	20GS-38FDHORX90M	E39
12GS-22FDLORX45	E34	Male Kobelco (Male French GAZ)	E39
16GS-28FDLORX45	E34	12GS-22MKB	E39
Female DIN 24° Cone Swivel - Light Series with O-Ring - 90° Bent Tube	E35	12GS-28MKB	E39
6GS-12FDLORX90	E35	16GS-28MKB	E39
8GS-15FDLORX90	E35	16GS-35MKB	E39
10GS-18FDLORX90	E35	Male British Standard Pipe Parallel	E39
12GS-22FDLORX90M	E35	6GS-6MBSPP	E39
16GS-28FDLORX90M	E35	8GS-8MBSPP	E39
Male French GAZ	E35	10GS-10MBSPP	E39
8GS-17MFG	E35	10GS-12MBSPP	E39
12GS-21MFG	E35	12GS-12MBSPP	E39
12GS-27MFG	E35	16GS-16MBSPP	E39
16GS-34MFG	E35	20GS-20MBSPP	E39
Female French GAZ Swivel (Female Kobelco)	E36	Female British Standard Parallel Pipe O-Ring Swivel	E40
8GS-17FFGX	E36	6GS-6FBSPORX	E40
10GS-21FFGX	E36	6GS-8FBSPORX	E40
12GS-21FFGX	E36	8GS-8FBSPORX	E40
12GS-27FFGX	E36	10GS-10FBSPORX	E40
16GS-27FFGX	E36	10GS-12FBSPORX	E40
16GS-34FFGX	E36	12GS-12FBSPORX	E40
Female French GAZ Swivel - 90° Bent Tube (Female Kobelco)	E36	12GS-16FBSPORX	E40
10GS-21FFGX90	E36	16GS-16FBSPORX	E40
12GS-21FFGX90	E36	16GS-20FBSPORX	E40
12GS5K-27FFGX90-060	E36	20GS-20FBSPORX	E40
16GS-27FFGX90	E36	Female British Standard Parallel Pipe O-Ring Swivel - 45° Bent Tube	E40
16GS5K-34FFGX90-065	E36	6GS-6FBSPORX45	E40
Male DIN 24° Cone - Heavy Series	E37	8GS-8FBSPORX45M	E40
6GS-12MDH	E37	10GS-10FBSPORX45	E40
6GS-14MDH	E37	12GS-12FBSPORX45	E40
8GS-16MDH	E37	16GS-16FBSPORX45M	E40
10GS-20MDH	E37	20GS-20FBSPORX45M	E40
12GS-20MDH	E37	Female British Standard Parallel Pipe O-Ring Swivel - 90° Bent Tube	E41
12GS-25MDH	E37	6GS-6FBSPORX90	E41
12GS-30MDH	E37	8GS-8FBSPORX90M	E41
16GS-25MDH	E37	10GS-10FBSPORX90	E41
16GS-30MDH	E37	12GS-12FBSPORX90	E41
20GS-38MDH	E37	16GS-16FBSPORX90	E41
Female DIN 24° Cone Swivel - Heavy Series with O-Ring	E37	20GS-20FBSPORX90M	E41
6GS-10FDHORX	E37	Female British Standard Parallel Pipe O-Ring Swivel - 90° Block	E41
6GS-12FDHORX	E37	12GS-12FBSPORX90BL	E41
6GS-14FDHORX	E37	Female British Flat-Face Swivel	E42
8GS-12FDHORX	E37	16GS-16FBFFX	E42
8GS-14FDHORX	E37	Female Komatsu Style Japanese Metric Swivel	E42
8GS-16FDHORX	E37	8GS-8FKX	E42
8GS-20FDHORX	E37	10GS-10FKX	E42
10GS-20FDHORX	E37	12GS-12FKX	E42
10GS-25FDHORX	E37	16GS-16FKX	E42



Category	Page	Category	Page
<b>GlobalSpiral™ Couplings (Continued)</b>		<b>GlobalSpiral™ Plus Couplings (Continued)</b>	
Female Japanese Industrial Standard 30° Flare Swivel	E42	Female JIC 37° Flare Swivel (Continued)	E52
12GS-12FJISX	E42	24GSP-32FJX	E52
16GS-16FJISX	E42	32GSP-32FJX	E52
20GS-20FJISX	E43	Female JIC 37° Flare Swivel - 45° Bent Tube	E52
GS Ferrule for Wire Braid Hose	E43	24GSP-24FJX45-050	E52
6GS1F-1	E43	Female JIC 37° Flare Swivel - 90° Bent Tube	E53
6GS1F-2	E43	24GSP-24FJX90-089	E53
8GS1F-2	E43	24GSP-24FJX90-118	E53
10GS1F-2	E43	32GSP-32FJX90M	E53
12GS1F-2	E43	Male Flat-Face O-Ring	E53
16GS1F-2	E43	24GSP-24MFFOR	E53
20GS1F-2	E43	Female Flat-Face O-Ring Swivel	E53
GS Ferrule for 4-Spiral Hose	E43	24GSP-24FFORX	E53
6GS1F-4	E43	Female Flat-Face O-Ring Swivel - 45° Bent Tube	E54
8GS1F-4	E43	24GSP-24FFORX45-036	E54
10GS1F-4	E43	Female Flat-Face O-Ring Swivel - 90° Bent Tube	E54
12GS1F-4	E43	24GSP-24FFORX90M	E54
16GS1F-4	E43	24GSP-24FFORX90L	E54
20GS1F-4	E43	Code 61 O-Ring Flange	E55
GS Ferrule for 6-Spiral Hose	E44	24GSP-20FL	E55
20GS1F-6	E44	24GSP-24FL	E55
GS Ferrule for ID5K Hose	E44	24GSP-32FL	E55
8GSID1F-4	E44	32GSP-24FL	E55
10GSID1F-4	E44	32GSP-32FL	E55
12GSID1F-4	E44	32GSP-40FL	E55
16GSID1F-4	E44	Code 61 O-Ring Flange - 22 1/2° Bent Tube	E55
1 1/4" Special One-Piece Couplings - Male Pipe (NPTF - 30° Cone Seat)	E44	24GSP-24FL22M	E55
20MGS-20MP	E44	24GSP-32FL22M	E55
1 1/4" Special One-Piece Couplings - Male JIC 37° Flare	E45	32GSP-32FL22M	E55
20MGS-20MJ	E45	Code 61 O-Ring Flange - 30° Bent Tube	E56
1 1/4" Special One-Piece Couplings - Female JIC 37° Flare Swivel	E45	24GSP-24FL30S	E56
20MGS-20FJX	E45	24GSP-32FL30M	E56
1 1/4" Special One-Piece Couplings - Female JIC 37° Flare Swivel - 90° Bent Tube	E46	32GSP-32FL30M	E56
20MGS-20FJX90M-078	E46	Code 61 O-Ring Flange - 45° Bent Tube	E56
1 1/4" Special One-Piece Couplings - Female Flat-Face O-Ring Swivel	E46	24GSP-20FL45S	E56
20MGS-20FFORX	E46	24GSP-24FL45S	E56
1 1/4" Special One-Piece Couplings - Female Flat-Face O-Ring Swivel - 90° Bent Tube	E47	24GSP-32FL45S	E56
20MGS-20FFORX90M	E47	32GSP-24FL45S	E56
1 1/4" Special One-Piece Couplings - Code 61 O-Ring Flange	E47	32GSP-32FL45-066	E56
20MGS-20FL	E47	Code 61 O-Ring Flange - 60° Bent Tube	E57
1 1/4" Special One-Piece Couplings - Code 61 O-Ring Flange - 45° Bent Tube	E48	24GSP-24FL60S	E57
20MGS-20FL45S-032	E48	24GSP-32FL60S	E57
1 1/4" Special One-Piece Couplings - Code 61 O-Ring Flange - 90° Bent Tube	E48	32GSP-32FL60S	E57
20MGS-20FL90M-090	E48	Code 61 O-Ring Flange - 67 1/2° Bent Tube	E57
1 1/4" Special One-Piece Couplings - Code 62 O-Ring Flange	E49	24GSP-24FL67S	E57
20MGS-20FLH	E49	24GSP-32FL67S	E57
1 1/4" Special One-Piece Couplings - Male DIN 24° Cone - Heavy Series	E49	Code 61 O-Ring Flange - 90° Bent Tube	E58
20MGS-38MDH	E49	24GSP-20FL90S	E58
1 1/4" Special One-Piece Couplings - Female DIN 24° Cone Swivel - Heavy Series with O-Ring	E49	24GSP-24FL90S	E58
20MGS-38FDHORX	E49	24GSP-24FL90M	E58
1 1/4" Special One-Piece Couplings - Female British Standard Pipe Parallel O-Ring Swivel	E50	24GSP-24FL90-148	E58
20MGS-20FBSPORX	E50	24GSP-32FL90S	E58
		24GSP-32FL90-080	E58
		24GSP-32FL90-170	E58
		32GSP-24FL90S	E58
		32GSP-32FL90-114	E58
		32GSP-32FL90-165	E58
		32GSP-32FL90-200	E58
		32GSP-40FL90-110	E58
<b>GlobalSpiral™ Plus Couplings</b>		Code 61 O-Ring Flange - 110° Bent Tube	E58
Male Pipe (NPTF - 30° Cone Seat)	E51	24GSP-24FL110-094	E58
24GSP-24MP	E51	32GSP-32FL110-140	E58
32GSP-32MP	E51	Code 61 O-Ring Flange - 120° Bent Tube	E59
API Line Pipe Connection	E51	24GSP-24FL120-119	E59
24GSP-24API-LP	E51	Code 61 O-Ring Flange - 125° Bent Tube	E59
32GSP-32MPAPI	E51	32GSP-32FL125-150	E59
Male Pipe (NPTF - 30° Cone Seat) - Long Hex	E51	Code 62 O-Ring Flange Heavy	E60
24GSP-24MPLH	E51	24GSP-24FLH	E60
Male JIC 37° Flare	E52	24GSP-32FLH	E60
24GSP-20MJ	E52	32GSP-32FLH	E60
24GSP-24MJ	E52		
32GSP-32MJ	E52		
Female JIC 37° Flare Swivel	E52		
24GSP-24FJX	E52		



Category	Page	Category	Page
<b>GlobalSpiral™ Plus Couplings (Continued)</b>		<b>GlobalSpiral™ MAX Pressure Couplings (Continued)</b>	
Code 62 O-Ring Flange Heavy - 45° Bent Tube	E60	Female JIC 37° Flare Swivel - 90° Bent Tube	E69
24GSP-24FLH45M	E60	24GSM-24FJX90M	E69
24GSP-32FLH45S	E60	Female Flat-Face Swivel	E70
32GSP-32FLH45-066	E60	24GSM4K-24FFORX	E70
Code 62 O-Ring Flange Heavy - 90° Bent Tube	E61	32GSM-32FFORX	E70
24GSP-24FLH90-094	E61	Female Flat-Face Swivel - 45° Bent Tube	E70
24GSP-32FLH90S	E61	24GSM4K-24FFORX45-038	E70
32GSP-32FLH90M	E61	Female Flat-Face Swivel - 90° Bent Tube	E70
Code 61 Flange without O-Ring Groove	E61	24GSM4K-24FFORX90M	E70
24GSP-24FLFF	E61	Code 61 O-Ring Flange	E71
Hose Length Extender	E61	24GSM-24FL	E71
24GSP-24HLE	E61	24GSM-32FL	E71
32GSP-32HLE	E62	32GSM-32FL	E71
Hose Length Extender - 90° Bent Tube	E62	40GSM-40FL	E71
24GSP-24HLE90-182	E62	Code 61 O-Ring Flange - 30° Bent Tube	E71
Male DIN 24° Cone - Light Series	E62	24GSM-24FL30M	E71
24GSP-42MDL	E62	Code 61 O-Ring Flange - 45° Bent Tube	E72
Female DIN 24° Cone Swivel - Light Series with O-Ring	E63	24GSM-24FL45M	E72
24GSP-42FDLORX	E63	24GSM-32FL45S	E72
32GSP-42FDLORX	E63	32GSM-32FL45M	E72
Female DIN 24° Cone Swivel - Light Series with O-Ring - 45° Bent Tube	E63	Code 61 O-Ring Flange - 60° Bent Tube	E72
24GSP-42FDLORX45	E63	24GSM-24FL60M	E72
Female DIN 24° Cone Swivel - Light Series with O-Ring - 90° Bent Tube	E63	Code 61 O-Ring Flange - 90° Bent Tube	E73
24GSP-42FDLORX90	E63	24GSM-24FL90S	E73
Female DIN 24° Cone Swivel - Heavy Series with O-Ring	E64	32GSM-32FL90-130	E73
24GSP-38FDHORX	E64	Code 62 O-Ring Flange Heavy	E73
Female DIN 24° Cone Swivel - Heavy Series with O-Ring - 90° Bent Tube	E64	24GSM-20FLH	E73
24GSP-38FDHORX90	E64	24GSM-24FLH	E73
Male British Standard Pipe Tapered	E64	24GSM-32FLH	E73
24GSP-24MBSPT	E64	32GSM-24FLH	E73
Female British Standard Parallel Pipe O-Ring Swivel	E65	32GSM-32FLH	E73
24GSP-24FBSPORX	E65	Code 62 O-Ring Flange Heavy - 22° Bent Tube	E74
32GSP-32FBSPORX	E65	24GSM-24FLH22M	E74
Female British Standard Parallel Pipe O-Ring Swivel - 45° Bent Tube	E65	24GSM-24FLH20-024	E74
24GSP-24FBSPORX45	E65	Code 62 O-Ring Flange Heavy - 30° Bent Tube	E74
32GSP-32FBSPORX45	E65	24GSM-24FLH30M	E74
Female British Standard Parallel Pipe O-Ring Swivel - 90° Bent Tube	E66	24GSM-24FLH30-28	E74
24GSP-24FBSPORX90	E66	32GSM-32FLH30-040	E74
32GSP-32FBSPORX90	E66	Code 62 O-Ring Flange Heavy - 45° Bent Tube	E74
Female Komatsu Style Japanese Metric Swivel	E66	24GSM-24FLH45M	E74
24GSP-24FKX	E66	24GSM-32FLH45M	E74
Female Japanese Industrial Standard 30° Flare Swivel	E67	32GSM-32FLH45-063	E75
24GSP-24FJISX	E67	Code 62 O-Ring Flange Heavy - 60° Bent Tube	E75
GSP Ferrule for Wire Braid Hose	E67	24GSM-24FLH60M	E75
24GSP1F-2	E67	32GSM-32FLH60M	E75
32GSP1F-2	E67	Code 62 O-Ring Flange Heavy - 90° Bent Tube	E75
GSP Ferrule for 4-Spiral Hose	E67	24GSM-24FLH90-094	E75
24GSP1F-4	E67	24GSM-24FLH90-150	E75
32GSP1F-4	E67	24GSM-32FLH90S	E75
	E67	32GSM-32FLH90S	E75
	E67	32GSM-32FLH90M	E75
	E67	32GSM-32FLH90-159	E75
<b>GlobalSpiral™ MAX Pressure Couplings</b>		Code 62 O-Ring Flange Heavy with Captive Flange	E76
Male Pipe (NPTF - 30° Cone Seat)	E68	24GSM-24FLHCFM	E76
24GSM-24MP	E68	32GSM-32FLHCFM	E76
32GSM-32MP	E68	Code 62 O-Ring Flange Heavy with Captive Flange - 45° Bent Tube	E76
API Line Pipe Connection	E68	24GSM-24FLHCFM45M	E76
24GSM-24API-LP	E68	32GSM-32FLHCFM45-063	E76
32GSM-32API-LP	E68	Code 62 O-Ring Flange Heavy with Captive Flange - 90° Bent Tube	E76
40GSM-40API-LP	E68	24GSM-24FLHCFM90-094	E76
48GSM-48API-LP	E68	32GSM-32FLHCFM90-120	E77
Male JIC 37° Flare	E68	Code 62 O-Ring Flange Heavy Captive Flange Metric Bolts	E77
24GSM-24MJ	E68	40GSM-40FLHCFM	E77
32GSM-32MJ	E68	48GSM-48FLHCFM	E77
Female JIC 37° Flare Swivel	E69	Caterpillar Style O-Ring Flange	E77
24GSM-24FJX	E69	24GSM-24FLC	E77
32GSM-32FJX	E69	24GSM-24FLCL	E77
Female JIC 37° Flare Swivel - 45° Bent Tube	E69	24GSM-32FLC	E77
24GSM-24FJX45-034	E69	32GSM-32FLC	E77





Category	Page	Category	Page
<b>GlobalSpiral™ MAX Pressure Couplings (Continued)</b>		<b>Stainless Steel Spiral Couplings (Continued)</b>	
Caterpillar Style O-Ring Flange - 22° Bent Tube	E78	Female Flat-Face O-Ring Swivel Metric Hex	F3
24GSM-24FLC22-017	E78	6S-6FFORX-SS	F3
24GSM-32FLC22-022	E78	8S-8FFORX-SS	F3
Caterpillar Style O-Ring Flange - 30° Bent Tube	E78	10S-10FFORX-SS	F3
24GSM-24FLC30-023	E78	12S-12FFORX-SS	F3
24GSM-32FLC30-035	E78	16S-16FFORX-SS	F3
32GSM-32FLC30-035	E78	20S-20FFORX-SS	F3
Caterpillar Style O-Ring Flange - 45° Bent Tube	E79	24S-24FFORX-SS	F3
24GSM-24FLC45-039	E79	Code 61 O-Ring Flange	F3
24GSM-32FLC45-059	E79	12S-12FL-SS	F3
32GSM-32FLC45-064	E79	16S-16FL-SS	F3
Caterpillar Style O-Ring Flange - 60° Bent Tube	E79	20S-20FL-SS	F3
24GSM-24FLC60-055	E79	Code 62 O-Ring Flange Heavy	F4
24GSM-32FLC60-087	E79	12S-12FLH-SS	F4
32GSM-32FLC60-083	E79	16S-16FLH-SS	F4
Caterpillar Style O-Ring Flange - 90° Bent Tube	E80	20S-20FLH-SS	F4
24GSM-24FLC90-087	E80	24S-24FLH-SS	F4
24GSM-32FLC90-140	E80	32S-32FLH-SS	F4
32GSM-32FLC90-130	E80	Female DIN 24° Cone Swivel - Heavy Series with O-Ring	F4
Hose Length Extender	E80	16S-30FDHORX-SS	F4
32GSM-32HLE	E80	Female DIN 24° Cone Swivel - Heavy Series with O-Ring - 90° Bent Tube	F5
40GSM-40HLE	E80	16S-30FDHORX90-SS	F5
48GSM-48HLE	E80	Non-Skive Ferrules	F5
Hose Length Extender for Caterpillar with Clamping Area	E81	10S1F-2SS	F5
24GSM-24HLEC	E81	12S1F-2SS	F5
Female DIN 24° Cone Swivel - Heavy Series with O-Ring	E81	16S1F-2SS	F5
24GSM-38FDHORX	E81	6S1F-4SS	F5
Female DIN 24° Cone Swivel - Heavy Series with O-Ring - 45° Bent Tube	E81	8S1F-4SS	F5
24GSM-38FDHORX45	E81	10S1F-4SS	F5
Female DIN 24° Cone Swivel - Heavy Series with O-Ring - 90° Bent Tube	E82	12S1F-4SS	F5
24GSM-38FDHORX90	E82	16S1F-4SS	F5
Male British Standard Pipe Parallel	E82	20S1F-4SS	F5
24GSM-24MBSPP	E82	20S1F-6SS	F5
32GSM-32MBSPP	E82	Skive Ferrules	F6
Female British Standard Parallel Pipe O-Ring Swivel	E82	24S2F-6SS	F6
24GSM-24FBSPORX	E82	32S2F-6SS	F6
32GSM-32FBSPORX	E82	<b>MegaCrimp® Couplings</b>	
Female British Standard Parallel Pipe O-Ring Swivel - 45° Bent Tube	E83	Male Pipe (NPTF - 30° Cone Seat)	G5
24GSM-24FBSPORX45	E83	4G-2MP	G5
32GSM-32FBSPORX45	E83	4G-4MP	G5
Female British Standard Parallel Pipe O-Ring Swivel - 90° Bent Tube	E83	4G-6MP	G5
24GSM-24FBSPORX90	E83	4G-8MP	G5
32GSM-32FBSPORX90	E83	5G-4MP	G5
ISO 6164 4-bolt Square Heavy Captive Flange	E83	5G-6MP	G5
40GSM-63FLSHCF	E83	6G-4MP	G5
48GSM-80FLSHCF	E83	6G-6MP	G5
GSM Butt Weld	E84	6G-8MP	G5
40GSM-40XXSBW	E84	8G-4MP	G5
48GSM-48XXSBW	E84	8G-6MP	G5
		8G-8MP	G5
		8G-12MP	G5
		10G-8MP	G5
		10G-12MP	G5
		12G-8MP	G5
		12G-12MP	G5
		12G-16MP	G5
		16G-12MP	G5
		16G-16MP	G5
		20G-20MP	G5
		Male Pipe Long Nose	G5
		4G-4MPLN	G5
		4G-6MPLN	G5
		6G-4MPLN	G5
		6G-6MPLN	G5
		Male Pipe Swivel (NPTF - without 30° Cone Seat)	G6
		4G-2MPX	G6
		4G-4MPX	G6
		4G-6MPX	G6
		4G-8MPX	G6
		6G-4MPX	G6
		6G-6MPX	G6
		6G-8MPX	G6
		8G-6MPX	G6
		8G-8MPX	G6



Category	Page	Category	Page
<b>MegaCrimp® Couplings (Continued)</b>		<b>MegaCrimp® Couplings (Continued)</b>	
Male Pipe Swivel (NPTF - without 30° Cone Seat) (Continued)		Male O-Ring Boss Swivel - 90° Block	G10
10G-12MPX	G6	4G-5MBX90BL	G10
12G-8MPX	G6	4G-6MBX90BL	G10
12G-12MPX	G6	6G-6MBX90BL	G10
16G-16MPX	G6	6G-8MBX90BL	G10
Male Pipe Swivel - 90° Block (NPTF - without 30° Cone Seat)	G6	6G-10MBX90BL	G10
4G-2MPX90	G6	8G-8MBX90BL	G10
4G-4MPX90	G6	8G-8MBX90BLL	G10
4G-6MPX90	G6	8G-10MBX90BL	G10
6G-4MPX90	G6	8G-10MBX90BLL	G10
6G-6MPX90	G6	8G-12MBX90BL	G10
6G-8MPX90	G6	8G-12MBX90BLL	G10
8G-6MPX90	G6	10G-10MBX90BL	G10
8G-8MPX90	G6	10G-10MBX90BLL	G10
12G-12MPX90	G6	12G-12MBX90BL	G10
12G-12MPX90L	G6	12G-12MBX90BLL	G10
Male Pipe Swivel - 90° Long Block (NPTF - without 30° Cone Seat)	G7	Male O-Ring Boss Swivel - 45° Bent Tube	G11
6G-8MPX90L	G7	6G-6MBX45	G11
8G-8MPX90L	G7	6G-8MBX45	G11
12G-12MPX90L	G7	8G-8MBX45	G11
Female Pipe (NPTF - without 30° Cone Seat)	G7	8G-10MBX45	G11
4G-2FP	G7	Male O-Ring Boss Swivel - 90° Bent Tube	G11
4G-4FP	G7	4G-6MBX90	G11
4G-6FP	G7	6G-6MBX90	G11
6G-4FP	G7	6G-8MBX90	G11
6G-6FP	G7	6G-10MBX90	G11
6G-8FP	G7	8G-8MBX90	G11
8G-6FP	G7	8G-10MBX90	G11
8G-8FP	G7	8G-12MBX90	G11
12G-12FP	G7	10G-10MBX90	G11
Female Pipe Swivel (NPSM - 30° Cone Seat)	G8	10G-12MBX90	G11
4G-4FPX	G8	12G-12MBX90	G11
6G-6FPX	G8	Male O-Ring Boss Adapterless Swivel - 90° Bent Tube	G12
6G-8FPX	G8	4G-4MBAX90M	G12
8G-8FPX	G8	6G-6MBAX90M	G12
12G-12FPX	G8	8G-8MBAX90M	G12
16G-16FPX	G8	10G-10MBAX90M	G12
20G-20FPX	G8	12G-12MBAX90M	G12
Male O-Ring Boss	G8	Male JIC 37° Flare	G12
4G-4MB	G8	4G-4MJ	G12
4G-5MB	G8	4G-5MJ	G12
4G-6MB	G8	4G-6MJ	G12
6G-5MB	G8	5G-5MJ	G12
6G-6MB	G8	5G-6MJ	G12
6G-8MB	G8	6G-6MJ	G12
6G-10MB	G8	6G-8MJ	G12
6G-12MB	G8	6G-10MJ	G12
8G-8MB	G8	8G-8MJ	G12
8G-10MB	G8	8G-10MJ	G12
8G-12MB	G8	8G-12MJ	G12
10G-8MB	G8	10G-8MJ	G12
10G-10MB	G8	10G-10MJ	G12
10G-12MB	G8	10G-12MJ	G12
12G-10MB	G8	12G-10MJ	G12
12G-12MB	G8	12G-12MJ	G12
12G-14MB	G8	12G-14MJ	G13
12G-16MB	G8	12G-16MJ	G13
16G-14MB	G8	16G-14MJ	G13
16G-16MB	G8	16G-16MJ	G13
16G-20MB	G8	16G-20MJ	G13
20G-20MB	G9	20G-20MJ	G13
Male O-Ring Boss Swivel	G9	20G-24MJ	G13
4G-4MBX	G9	Female JIC 37° Flare Swivel	G13
4G-6MBX	G9	4G-4FJX	G13
6G-6MBX	G9	4G-5FJX	G13
6G-8MBX	G9	4G-6FJX	G13
6G-10MBX	G9	5G-5FJX	G13
8G-8MBX	G9	5G-6FJX	G13
8G-10MBX	G9	6G-4FJXSP	G13
10G-10MBX	G9	6G-4FJX	G13
12G-12MBX	G9	6G-5FJXSP	G13
Male O-Ring Boss Swivel - 45° Block	G9	6G-5FJX	G13
6G-6MBX45BL	G9	6G-6FJX	G13
6G-8MBX45BL	G9	6G-8FJX	G13
8G-8MBX45BL	G9	6G-10FJX	G13
8G-10MBX45BL	G10	6G-12FJX	G13
		8G-6FJXSP	G13
		8G-6FJX	G13



Category	Page	Category	Page
<b>MegaCrimp® Couplings (Continued)</b>		<b>MegaCrimp® Couplings (Continued)</b>	
Female JIC 37° Flare Swivel (Continued)	G13	Female JIC 37° Flare Swivel - 90° Bent Tube (Continued)	G16
8G-8FJX	G13	10G-12FJX90S	G16
8G-10FJX	G13	10G-12FJX90M	G16
8G-12FJX	G13	10G-12FJX90L	G16
8G-16FJX	G13	12G-10FJX90M	G16
10G-8FJXSP	G13	12G-12FJX90S	G16
10G-8FJX	G13	12G-12FJX90M	G16
10G-10FJX	G13	12G-12FJX90L	G16
10G-12FJX	G13	12G-14FJX90-054	G16
10G-14FJX	G13	12G-14FJX90-100	G16
12G-8FJX	G13	12G-16FJX90S	G16
12G-10FJXSP	G13	12G-16FJX90M	G16
12G-10FJX	G13	16G-16FJX90S	G16
12G-12FJX	G13	16G-16FJX90M	G16
12G-14FJX	G13	16G-16FJX90L	G16
12G-16FJX	G13	16G-20FJX90S	G16
16G-12FJXSP	G14	20G-20FJX90M	G16
16G-12FJX	G14	20G-20FJX90L	G16
16G-14FJXSP	G14	20G-20FJX90-089	G16
16G-14FJX	G14	Female JIC 37° Flare Swivel - 90° Block	G16
16G-16FJX	G14	12G-16FJX90BLK	G16
16G-20FJX	G14	Male SAE 45° Flare	G17
20G-20FJX	G14	4G-4MS	G17
20G-24FJX	G14	4G-5MS	G17
Female JIC 37° Flare Swivel - 30° Bent Tube	G14	6G-6MS	G17
10G-12FJX30-018	G14	6G-8MS	G17
12G-10FJX30-018	G14	8G-8MS	G17
Female JIC 37° Flare Swivel - 45° Bent Tube	G14	8G-10MS	G17
4G-4FJX45S	G14	12G-12MS	G17
4G-5FJX45-011	G14	Female SAE 45° Flare Swivel	G17
4G-6FJX45S	G14	4G-4FSX	G17
5G-5FJX45-011	G14	4G-5FSX	G17
5G-6FJX45S	G14	4G-6FSX	G17
6G-4FJX45S	G14	5G-6FSX	G17
6G-6FJX45S	G14	6G-6FSX	G17
6G-8FJX45S	G14	6G-8FSX	G17
8G-8FJX45S	G14	8G-8FSX	G17
8G-10FJX45S	G14	8G-10FSX	G17
10G-10FJX45S	G15	12G-12FSX	G17
10G-12FJX45S	G15	Female SAE 45° Flare Swivel - 45° Bent Tube	G18
12G-10FJX45S	G15	4G-4FSX45	G18
12G-12FJX45S	G15	4G-5FSX45-009	G18
12G-16FJX45S	G15	6G-6FSX45	G18
16G-12FJX45S	G15	6G-8FSX45-014	G18
16G-16FJX45S	G15	8G-8FSX45	G18
20G-20FJX45-035	G15	8G-10FSX45-016	G18
Female JIC 37° Flare Swivel - 90° Bent Tube	G15	12G-12FSX45	G18
4G-4FJX90S	G15	Female SAE 45° Flare Swivel - 90° Bent Tube	G18
4G-4FJX90M	G15	4G-4FSX90	G18
4G-4FJX90L	G15	4G-5FSX90-046	G18
4G-5FJX90-023	G15	5G-6FSX90-022	G18
4G-5FJX90M	G15	6G-6FSX90	G18
4G-5FJX90L	G15	6G-6FSX90-055	G18
4G-6FJX90S	G15	6G-8FSX90	G18
4G-6FJX90M	G15	8G-8FSX90	G18
4G-6FJX90L	G15	8G-10FSX90-031	G18
5G-6FJX90S	G15	12G-12FSX90	G18
5G-6FJX90M	G15	Male Flat-Face O-Ring	G19
6G-4FJX90S	G15	4G-4MFFOR	G19
6G-4FJX90L	G15	4G-6MFFOR	G19
6G-6FJX90S	G15	5G-6MFFOR	G19
6G-6FJX90M	G15	6G-6MFFOR	G19
6G-6FJX90L	G15	6G-8MFFOR	G19
6G-8FJX90S	G15	6G-10MFFOR	G19
6G-8FJX90M	G15	8G-8MFFOR	G19
6G-8FJX90L	G15	8G-10MFFOR	G19
6G-10FJX90M	G15	8G-12MFFOR	G19
8G-6FJX90S	G15	10G-10MFFOR	G19
8G-8FJX90S	G15	10G-12MFFOR	G19
8G-8FJX90M	G15	12G-12MFFOR	G19
8G-8FJX90L	G15	12G-16MFFOR	G19
8G-10FJX90S	G15	16G-16MFFOR	G19
8G-10FJX90M	G15	16G-20MFFOR	G19
8G-10FJX90L	G15	20G-20MFFOR	G19
8G-10FJX90-089	G15	Male Flat-Face O-Ring Bulk Head Long Nose	G19
8G-12FJX90S	G15	6G-6MFFORBKHDLN	G19
10G-10FJX90-036	G16		
10G-10FJX90M	G16		
10G-10FJX90L	G16		





Category	Page	Category	Page
<b>MegaCrimp® Couplings (Continued)</b>		<b>MegaCrimp® Couplings (Continued)</b>	
Male Flat-Face O-Ring Bulk Head Long Nose (Continued)	G19	Female Flat-Face O-Ring Swivel - 90° Bent Tube (Continued)	G23
8G-8MFFORBKHDLN	G19	8G-10FFORX90L	G23
Male Flat-Face O-Ring Bulk Head	G20	8G-12FFORX90S	G23
4G-4MFFORBKHD	G20	10G-8FFORX90S	G23
6G-6MFFORBKHD	G20	10G-8FFORX90L	G23
Female Flat-Face O-Ring Swivel	G20	10G-10FFORX90S	G23
4G-4FFORX	G20	10G-10FFORX90M	G23
4G-6FFORX	G20	10G-10FFORX90L	G23
4G-8FFORX	G20	10G-12FFORX90S	G23
5G-6FFORX	G20	10G-12FFORX90S	G23
6G-4FFORX	G20	12G-10FFORX90S	G23
6G-6FFORX	G20	12G-12FFORX90S	G23
6G-8FFORX	G20	12G-12FFORX90M	G23
6G-10FFORX	G20	12G-12FFORX90L	G23
8G-6FFORX	G20	12G-16FFORX90S	G23
8G-8FFORX	G20	16G-12FFORX90S	G23
8G-10FFORX	G20	16G-16FFORX90S	G23
8G-12FFORX	G20	16G-16FFORX90M	G23
10G-8FFORX	G20	16G-16FFORX90L	G23
10G-10FFORX	G20	16G-20FFORX90S	G23
10G-12FFORX	G20	16G-20FFORX90M	G23
12G-10FFORX	G20	20G-20FFORX90S	G23
12G-12FFORX	G20	20G-20FFORX90M	G23
12G-16FFORX	G20	20G-20FFORX90L	G23
16G-12FFORX	G20	Code 61 O-Ring Flange	G23
16G-16FFORX	G20	8G-8FL	G23
16G-20FFORX	G20	8G-12FL	G23
20G-20FFORX	G20	12G-12FL	G23
20G-24FFORX	G20	12G-16FL	G23
Female Flat-Face O-Ring Swivel - 30° Bent Tube	G21	16G-12FL	G23
8G-10FFORX30-010	G21	16G-16FL	G23
Female Flat-Face O-Ring Swivel - 45° Bent Tube	G21	16G-20FL	G23
4G-4FFORX45S	G21	16G-24FL	G23
4G-6FFORX45S	G21	20G-20FL	G23
5G-6FFORX45S	G21	20G-24FL	G23
6G-4FFORX45S	G21	Komatsu O-Ring Flange - Straight	G24
6G-6FFORX45S	G21	8G-10FLK	G24
6G-8FFORX45S	G21	10G-10FLK	G24
8G-6FFORX45S	G21	Code 61 O-Ring Flange - 22 1/2° Bent Tube	G24
8G-8FFORX45S	G21	12G-12FL22M	G24
8G-10FFORX45S	G21	12G-16FL22M-014	G24
8G-12FFORX45S	G21	16G-16FL22M	G24
10G-8FFORX45S	G21	20G-20FL22M	G24
10G-10FFORX45S	G21	Code 61 O-Ring Flange - 30° Bent Tube	G24
10G-12FFORX45S	G21	12G-12FL30M	G24
12G-10FFORX45S	G21	12G-16FL30M	G24
12G-12FFORX45S	G21	16G-16FL30M	G24
12G-16FFORX45S	G21	16G-20FL30M	G24
16G-12FFORX45S	G21	20G-20FL30S	G25
16G-16FFORX45S	G21	Code 61 O-Ring Flange - 45° Bent Tube	G25
20G-20FFORX45S	G21	8G-8FL45M	G25
Female Flat-Face O-Ring Swivel - 67 1/2° Bent Tube	G22	8G-12FL45M	G25
8G-8FFORX67-022	G22	10G-12FL45M	G25
Female Flat-Face O-Ring Swivel - 90° Bent Tube	G22	12G-12FL45M	G25
4G-4FFORX90S	G22	12G-16FL45S	G25
4G-4FFORX90M	G22	16G-16FL45S	G25
4G-4FFORX90L	G22	16G-20FL45S	G25
4G-6FFORX90S	G22	16G-24FL45	G25
4G-6FFORX90M	G22	20G-20FL45S	G25
4G-6FFORX90L	G22	Komatsu O-Ring Flange - 45° Bent Tube	G25
4G-8FFORX90S	G22	10G-10FLK45	G25
4G-8FFORX90L	G22	Code 61 O-Ring Flange - 60° Bent Tube	G26
5G-6FFORX90S	G22	12G-12FL60M	G26
6G-4FFORX90S	G22	12G-16FL60M	G26
6G-6FFORX90S	G22	16G-16FL60M	G26
6G-6FFORX90M	G22	20G-20FL60S	G26
6G-6FFORX90L	G22	Code 61 O-Ring Flange - 67 1/2° Bent Tube	G26
6G-8FFORX90S	G22	12G-12FL67M	G26
6G-8FFORX90M	G22	20G-20FL67S	G26
6G-8FFORX90L	G22	Code 61 O-Ring Flange - 90° Bent Tube	G27
8G-6FFORX90S	G22	8G-8FL90M	G27
8G-6FFORX90L	G22	8G-12FL90M	G27
8G-8FFORX90M	G22	10G-12FL90M	G27
8G-8FFORX90L	G22	12G-12FL90M	G27
8G-10FFORX90S	G22	12G-16FL90S	G27
8G-10FFORX90M	G23	16G-12FL90M	G27



Category	Page	Category	Page
<b>MegaCrimp® Couplings (Continued)</b>		<b>MegaCrimp® Couplings (Continued)</b>	
Code 61 O-Ring Flange - 90° Bent Tube (Continued)	G27	US Banjo	G32
16G-16FL90S	G27	6G-6BJ	G32
16G-20FL90S	G27		
16G-24FL90S-081	G27	Male DIN 24° Cone - Light Series	G32
20G-20FL90S	G27	4G-6MDL	G32
20G-20FL90M	G27	4G-8MDL	G32
20G-20FL90-102	G27	4G-10MDL	G32
20G-24FL90S	G27	6G-10MDL	G32
		6G-12MDL	G32
Komatsu O-Ring Flange - 90° Bent Tube	G27	6G-15MDL	G32
10G-10FLK90	G27	8G-15MDL	G32
		10G-18MDL	G32
SAE Male Inverted Swivel	G28	10G-22MDL	G32
4G-3MIX	G28	12G-18MDL	G32
4G-4MIX	G28	12G-22MDL	G32
4G-5MIX	G28	16G-28MDL	G32
6G-4MIX	G28	20G-35MDL	G32
6G-5MIX	G28		
6G-6MIX	G28	Female DIN 24° Cone Swivel - Light Series with O-Ring	G33
6G-7MIX	G28	4G-6FDLORX	G33
8G-6MIX	G28	4G-8FDLORX	G33
8G-8MIX	G28	4G-10FDLORX	G33
10G-10MIX	G28	4G-12FDLORX	G33
		5G-10FDLORX	G33
SAE Male Inverted Swivel - 45° Bent Tube	G28	5G-12FDLORX	G33
4G-3MIX45-018	G28	6G-10FDLORX	G33
4G-4MIX45-024	G28	6G-12FDLORX	G33
6G-4MIX45	G28	6G-14FDLORX	G33
6G-5MIX45	G28	6G-15FDLORX	G33
6G-6MIX45	G28	8G-15FDLORX	G33
6G-7MIX45	G28	8G-18FDLORX	G33
8G-8MIX45	G28	10G-18FDLORX	G33
10G-10MIX45	G28	12G-18FDLORX	G33
		12G-22FDLORX	G33
SAE Male Inverted Swivel - 90° Bent Tube	G29	16G-28FDLORX	G33
4G-4MIX90	G29	20G-35FDLORX	G33
4G-5MIX90	G29	20G-42FDLORX	G33
5G-6MIX90-035	G29		
6G-4MIX90	G29	Female DIN 24° Cone Swivel - Light Series with O-Ring - 45° Bent Tube	G33
6G-5MIX90	G29	4G-8FDLORX45	G33
6G-6MIX90	G29	4G-10FDLORX45	G33
6G-7MIX90	G29	5G-10FDLORX45	G33
8G-8MIX90	G29	6G-10FDLORX45	G33
10G-10MIX90	G29	6G-12FDLORX45	G33
		6G-15FDLORX45	G33
SAE Male Flareless Assembly	G29	8G-15FDLORX45	G33
4G-4MFA	G29	8G-18FDLORX45	G34
4G-5MFA	G29	10G-18FDLORX45	G34
5G-5MFA	G29	12G-22FDLORX45	G34
5G-6MFA	G29	16G-28FDLORX45	G34
6G-4MFA	G29	20G-35FDLORX45	G34
6G-5MFA	G29		
6G-6MFA	G29	Female DIN 24° Cone Swivel - Light Series with O-Ring - 90° Bent Tube	G34
6G-8MFA	G29	4G-6FDLORX90	G34
8G-8MFA	G29	4G-8FDLORX90	G34
8G-10MFA	G29	4G-10FDLORX90	G34
12G-12MFA	G29	5G-10FDLORX90	G34
16G-16MFA	G29	6G-10FDLORX90	G34
		6G-12FDLORX90	G34
North American Stand Pipe	G30	6G-15FDLORX90	G34
4G-4NASP	G30	8G-15FDLORX90	G34
6G-6NASP	G30	8G-18FDLORX90	G34
8G-8NASP	G30	10G-18FDLORX90	G34
12G-12NASP	G30	12G-18FDLORX90	G34
16G-16NASP	G30	12G-22FDLORX90	G34
		16G-28FDLORX90	G34
Hose Length Extender	G30	20G-35FDLORX90	G34
20G-20HLE	G30		
		Female French GAZ Swivel	G35
Female Air Brake Swivel	G30	8G-17FFGX	G35
6G-6FABX	G30	10G-21FFGX	G35
8G-6FABX	G30	12G-27FFGX	G35
8G-8FABX	G30		
		Male DIN 24° Cone - Heavy Series	G35
Female Grease	G31	4G-8MDH	G35
4G-8FG	G31	4G-10MDH	G35
6G-8FG	G31	5G-12MDH	G35
		6G-10MDH	G35
Female Parker Triple Thread Flare	G31	6G-12MDH	G35
16G-16FZX	G31	6G-14MDH	G35
		8G-12MDH	G35
Pressure Wash Swivel	G31	8G-16MDH	G35
4G-6PWX	G31	10G-20MDH	G35
6G-6PWX	G31		



Category	Page	Category	Page
<b>MegaCrimp® Couplings (Continued)</b>		<b>MegaCrimp® Couplings (Continued)</b>	
Male DIN 24° Cone - Heavy Series (Continued)	G35	Male British Standard Pipe Tapered/Japanese Tapered Thread (Continued)	G39
12G-20MDH	G35	8G-8MBSPT	G39
12G-25MDH	G35	10G-10MBSPT	G39
16G-30MDH	G35	12G-12MBSPT	G39
20G-38MDH	G35	16G-16MBSPT	G39
Female DIN 24° Cone Swivel - Heavy Series with O-Ring	G36	Male British Standard Parallel Pipe	G39
4G-8FDHORX	G36	4G-4MBSPP	G39
4G-10FDHORX	G36	6G-4MBSPP	G39
4G-12FDHORX	G36	6G-6MBSPP	G39
5G-12FDHORX	G36	6G-8MBSPP	G39
5G-14FDHORX	G36	8G-6MBSPP	G39
6G-10FDHORX	G36	8G-8MBSPP	G39
6G-12FDHORX	G36	10G-10MBSPP	G39
6G-14FDHORX	G36	10G-12MBSPP	G39
8G-12FDHORX	G36	12G-12MBSPP	G39
8G-14FDHORX	G36	16G-16MBSPP	G39
8G-16FDHORX	G36	20G-20MBSPP	G39
8G-20FDHORX	G36	Female British Standard Parallel Pipe O-Ring Swivel	G40
10G-16FDHORX	G36	4G-2FBSPPX	G40
10G-20FDHORX	G36	4G-4FBSPORX	G40
12G-20FDHORX	G36	4G-6FBSPORX	G40
12G-25FDHORX	G36	5G-6FBSPORX	G40
16G-25FDHORX	G36	5G-8FBSPORX	G40
16G-30FDHORX	G36	6G-6FBSPORX	G40
20G-38FDHORX	G36	6G-8FBSPORX	G40
Female DIN 24° Cone Swivel - Heavy Series with O-Ring - 45° Bent Tube	G36	8G-6FBSPORX	G40
4G-8FDHORX45	G36	8G-8FBSPORX	G40
4G-10FDHORX45	G36	8G-10FBSPORX	G40
6G-10FDHORX45	G36	8G-12FBSPORX	G40
6G-12FDHORX45	G36	10G-10FBSPORX	G40
6G-14FDHORX45	G36	10G-12FBSPORX	G40
8G-14FDHORX45	G36	12G-12FBSPORX	G40
8G-16FDHORX45	G37	12G-16FBSPORX	G40
10G-20FDHORX45	G37	16G-16FBSPORX	G40
12G-20FDHORX45	G37	20G-20FBSPORX	G40
12G-25FDHORX45	G37	Female British Standard Parallel Pipe O-Ring Swivel - 45° Bent Tube	G40
Female DIN 24° Cone Swivel - Heavy Series with O-Ring - 90° Bent Tube	G37	4G-4FBSPORX45	G40
4G-8FDHORX90	G37	6G-6FBSPORX45	G40
4G-10FDHORX90	G37	6G-8FBSPORX45	G40
5G-12FDHORX90	G37	8G-8FBSPORX45	G40
5G-14FDHORX90	G37	8G-10FBSPORX45	G40
6G-10FDHORX90	G37	10G-10FBSPORX45	G40
6G-12FDHORX90	G37	10G-12FBSPORX45	G40
6G-14FDHORX90	G37	12G-12FBSPORX45	G40
8G-14FDHORX90	G37	16G-16FBSPORX45	G40
8G-16FDHORX90	G37	20G-20FBSPORX45	G40
10G-20FDHORX90	G37	Female British Standard Parallel Pipe O-Ring Swivel - 90° Bent Tube	G41
10G-25FDHORX90	G37	4G-4FBSPORX90	G41
12G-20FDHORX90	G37	6G-6FBSPORX90	G41
12G-25FDHORX90	G37	6G-8FBSPORX90	G41
16G-25FDHORX90	G37	8G-8FBSPORX90	G41
20G-38FDHORX90	G37	8G-10FBSPORX90	G41
Metric Light Stand Pipe	G38	10G-10FBSPORX90	G41
4G-6MSP	G38	10G-12FBSPORX90	G41
4G-8MSP	G38	12G-12FBSPORX90	G41
4G-10MSP	G38	12G-16FBSPORX90	G41
6G-10MSP	G38	16G-16FBSPORX90	G41
6G-12MSP	G38	20G-20FBSPORX90	G41
8G-15MSP	G38	Female British Standard Parallel Pipe O-Ring Swivel - 90° Block	G41
10G-18MSP	G38	4G-4FBSPORX90BL	G41
10G-22MSP	G38	6G-6FBSPORX90BL	G41
12G-18MSP	G38	8G-8FBSPORX90BL	G41
12G-22MSP	G38	16G-16FBSPORX90BL	G41
16G-28MSP	G38	International Thread British Std Pipe Banjo	G42
International Thread Metric 7642 DIN Banjo	G38	4G-4BSPBJ	G42
4G-12DBJ	G38	6G-6BSPBJ	G42
6G-12DBJ	G38	8G-8BSPBJ	G42
6G-14DBJ	G38	12G-12BSPBJ	G42
6G-16DBJ	G38	Female British Flat-Face Swivel	G42
6G-18DBJ	G38	6G-6FBFFX	G42
8G-18DBJ	G38	6G-8FBFFX	G42
10G-22DBJ	G38	8G-8FBFFX	G42
12G-26DBJ	G38	8G-12FBFFX	G42
16G-30DBJ	G38	10G-12FBFFX	G42
Male British Standard Pipe Tapered/Japanese Tapered Thread	G39	12G-12FBFFX	G42
4G-4MBSPT	G39		
6G-6MBSPT	G39		



Category	Page	Category	Page
<b>MegaCrimp® Couplings (Continued)</b>		<b>MegaCrimp® Couplings (Continued)</b>	
Female Komatsu Style Japanese Metric Swivel	G43	Female Quick-Lok® High to Male O-Ring Boss Adapter (Continued)	G47
4G-4FKX	G43	12FQLH-16MB	G47
4G-6FKX	G43	16FQLH-12MB	G47
6G-6FKX	G43	16FQLH-16MB	G47
8G-8FKX	G43		
10G-10FKX	G43	Female Quick-Lok® High to Female JIC 37° Flare	G47
12G-12FKX	G43	4FQLH-4FJ	G47
16G-16FKX	G43	6FQLH-6FJ	G47
20G-20FKX	G43	8FQLH-8FJ	G47
		10FQLH-10FJ	G47
		16FQLH-16FJ	G47
Female Komatsu Style Japanese Metric Swivel - 45° Bent Tube	G43		
4G-4FKX45	G43	Female Quick-Lok® High to Female Flat-Face	G48
6G-6FKX45	G43	6FQLH-6FFOR	G48
8G-8FKX45	G43	8FQLH-8FFOR	G48
10G-10FKX45	G43	10FQLH-10FFOR	G48
12G-12FKX45	G43	12FQLH-12FFOR	G48
Female Komatsu Style Japanese Metric Swivel - 90° Bent Tube	G44	Male Quick-Lok® Low	G48
4G-4FKX90	G44	4G-6MQLL	G48
6G-6FKX90	G44	6G-6MQLL	G48
8G-8FKX90	G44	8G-8MQLL	G48
10G-10FKX90	G44	12G-12MQLL	G48
12G-12FKX90	G44	16G-16MQLL	G48
Female Japanese Industrial Standard Swivel	G44	Male Quick-Lok® Low - 45° Bent Tube	G49
4G-4FJISX	G44	4G-6MQLL45-026	G49
6G-6FJISX	G44	8G-8MQLL45-033	G49
8G-8FJISX	G44	12G-12MQLL45-030	G49
12G-12FJISX	G44	12G-12MQLL45-038	G49
16G-16FJISX	G44		
20G-20FJISX	G44	Male Quick-Lok® Low - 90° Bent Tube	G49
		4G-6MQLL90-037	G49
Female Japanese Inverted Flare Parallel Threads	G45	6G-6MQLL90-051	G49
4G-4FJISPX	G45	6G-6MQLL90-117	G49
6G-6FJISPX	G45	6G-6MQLL90-168	G49
8G-8FJISPX	G45	8G-8MQLL90-050	G49
12G-12JISPX	G45	12G-12MQLL90-061	G49
16G-16JISPX	G45		
20G-20JISPX	G45	<b>MegaCrimp® Couplings with TuffCoat® XTreme™ Plating</b>	
Male Quick-Lok® High	G45	Male Pipe (NPTF - 30° Cone Seat)	G50
4G-4MQLH	G45	4G-2MP-TCX	G50
6G-6MQLH	G45	4G-4MP-TCX	G50
8G-8MQLH	G45	4G-6MP-TCX	G50
10G-10MQLH	G45	4G-8MP-TCX	G50
12G-12MQLH	G45	6G-4MP-TCX	G50
16G-16MQLH	G45	6G-6MP-TCX	G50
		6G-8MP-TCX	G50
Male Quick-Lok® High - 45° Bent Tube	G46	8G-6MP-TCX	G50
4G-4MQLH45S-008	G46	8G-8MP-TCX	G50
6G-6MQLH45S-008	G46	8G-12MP-TCX	G50
8G-8MQLH45S-010	G46	10G-8MP-TCX	G50
10G-10MQLH45S-013	G46	10G-12MP-TCX	G50
12G-12MQLH45S-014	G46	12G-8MP-TCX	G50
16G-16MQLH45S-017	G46	12G-12MP-TCX	G50
		12G-16MP-TCX	G50
Male Quick-Lok® High - 90° Bent Tube	G46	16G-12MP-TCX	G50
4G-4MQLH90S-018	G46	16G-16MP-TCX	G50
4G-4MQLH90L-039	G46	20G-20MP-TCX	G50
6G-6MQLH90S-020	G46		
6G-6MQLH90L-046	G46	Female Pipe (NPTF - without 30° Cone Seat)	G50
8G-8MQLH90S-026	G46	4G-2FP-TCX	G50
8G-8MQLH90L-057	G46	4G-4FP-TCX	G50
10G-10MQLH90S-033	G46	6G-4FP-TCX	G50
10G-10MQLH90L-065	G46	6G-6FP-TCX	G50
12G-12MQLH90S-037	G46	6G-8FP-TCX	G50
12G-12MQLH90L-075	G46	8G-6FP-TCX	G50
16G-16MQLH90S-044	G46	8G-8FP-TCX	G50
16G-16MQLH90L-103	G46	12G-12FP-TCX	G50
Female Quick-Lok® High to Male O-Ring Boss Adapter	G47	Male JIC 37° Flare	G51
4FQLH-4MB	G47	12G-12MJ-TCX	G51
4FQLH-6MB	G47		
6FQLH-4MB	G47	Female JIC 37° Flare Swivel	G51
6FQLH-6MB	G47	4G-4FJX-TCX	G51
6FQLH-8MB	G47	4G-5FJX-TCX	G51
8FQLH-6MB	G47	4G-6FJX-TCX	G51
8FQLH-8MB	G47	6G-6FJX-TCX	G51
8FQLH-10MB	G47	6G-8FJX-TCX	G51
10FQLH-8MB	G47	6G-10FJX-TCX	G51
10FQLH-10MB	G47	8G-6FJX-TCX	G51
10FQLH-12MB	G47	8G-8FJX-TCX	G51
12FQLH-10MB	G47	8G-10FJX-TCX	G51
12FQLH-12MB	G47		



Category	Page	Category	Page
<b>MegaCrimp® Couplings with TuffCoat® XTreme™ Plating (Continued)</b>		<b>MegaCrimp® Couplings with TuffCoat® XTreme™ Plating (Continued)</b>	
Female JIC 37° Flare Swivel (Continued)	G51	Code 61 O-Ring Flange - 90° Bent Tube (Continued)	G55
8G-12FJX-TCX	G51	20G-20FL90S-TCX	G55
10G-8FJX-TCX	G51		
10G-10FJX-TCX	G51	<b>Stainless Steel Braid Couplings</b>	
10G-12FJX-TCX	G51		
12G-10FJX-TCX	G51	Male Pipe (NPTF - 30° Cone Seat)	H3
12G-12FJX-TCX	G51	4B-4MP-SS	H3
12G-14FJX-TCX	G51	6B-6MP-SS	H3
12G-16FJX-TCX	G51	8B-8MP-SS	H3
16G-12FJX-TCX	G51	12B-12MP-SS	H3
16G-16FJX-TCX	G51	16B-16MP-SS	H3
16G-20FJX-TCX	G51	20B-20MP-SS	H3
20G-20FJX-TCX	G51	24B-24MP-SS	H3
		32B-32MP-SS	H3
Female JIC 37° Flare Swivel - 45° Bent Tube	G52	Female JIC 37° Flare Swivel	H3
4G-6FJX45S-TCX	G52	6B-6FJX-SS	H3
6G-6FJX45S-TCX	G52	12B-12FJX-SS	H3
6G-8FJX45S-TCX	G52	16B-16FJX-SS	H3
8G-8FJX45S-TCX	G52	20B-20FJX-SS	H3
8G-10FJX45S-TCX	G52	24B-24FJX-SS	H3
10G-10FJX45S-TCX	G52	32B-32FJX-SS	H3
10G-12FJX45S-TCX	G52		
12G-12FJX45S-TCX	G52	Female JIC 37° Flare Swivel - 45° Bent Tube	H4
		6B-6FJX45S-SS	H4
Female JIC 37° Flare Swivel - 90° Bent Tube	G52	12B-12FJX45S-SS	H4
8G-8FJX90M-TCX	G52	16B-16FJX45S-SS	H4
10G-10FJX90M-TCX	G52		
		Female JIC 37° Flare Swivel - 90° Bent Tube	H4
Female Flat-Face O-Ring Swivel	G53	6B-6FJX90M-SS	H4
4G-4FFORX-TCX	G53	12B-12FJX90S-SS	H4
4G-6FFORX-TCX	G53	12B-12FJX90M-SS	H4
6G-4FFORX-TCX	G53	16B-16FJX90M-SS	H4
6G-6FFORX-TCX	G53		
6G-8FFORX-TCX	G53	Female SAE 45° Flare Swivel	H4
8G-6FFORX-TCX	G53	12B-12FSX-SS	H4
8G-8FFORX-TCX	G53		
8G-10FFORX-TCX	G53	Dual Seat Female JIC 37°/SAE 45° Flare Swivel	H5
8G-12FFORX-TCX	G53	4B-4FJSX-SS	H5
10G-10FFORX-TCX	G53	8B-8FJSX-SS	H5
10G-12FFORX-TCX	G53	10B-10FJSX-SS	H5
12G-10FFORX-TCX	G53		
12G-12FFORX-TCX	G53	Dual Seat Female JIC 37°/SAE 45° Flare Swivel - 45° Bent Tube	H5
12G-16FFORX-TCX	G53	4B-4FJSX45S-SS	H5
16G-16FFORX-TCX	G53	8B-8FJSX45S-SS	H5
16G-20FFORX-TCX	G53	10B-10FJSX45S-SS	H5
20G-20FFORX-TCX	G53		
		Dual Seat Female JIC 37°/SAE 45° Flare Swivel - 90° Bent Tube	H5
Female Flat-Face O-Ring Swivel - 45° Bent Tube	G53	4B-4FJSX90S-SS	H5
4G-4FFORX45S-TCX	G53	4B-4FJSX90M-SS	H6
4G-6FFORX45S-TCX	G53	8B-8FJSX90S-SS	H6
6G-4FFORX45S-TCX	G53	8B-8FJSX90M-SS	H6
6G-6FFORX45S-TCX	G53	10B-10FJSX90S-SS	H6
6G-8FFORX45S-TCX	G53	10B-10FJSX90M-SS	H6
8G-8FFORX45S-TCX	G53		
8G-10FFORX45S-TCX	G53	Female Flat-Face O-Ring Swivel Metric Hex	H6
10G-10FFORX45S-TCX	G53	4B-4FFORX-SS	H6
10G-12FFORX45S-TCX	G53	8B-8FFORX-SS	H6
12G-10FFORX45S-TCX	G53	10B-10FFORX-SS	H6
12G-12FFORX45S-TCX	G54	12B-12FFORX-SS	H6
12G-16FFORX45S-TCX	G54	16B-16FFORX-SS	H6
16G-16FFORX45S-TCX	G54	20B-20FFORX-SS	H6
20G-20FFORX45S-TCX	G54	24B-24FFORX-SS	H6
Female Flat-Face O-Ring Swivel - 90° Bent Tube	G54	Code 61 O-Ring Flange	H6
4G-4FFORX90S-TCX	G54	24B-24FL-SS	H6
4G-6FFORX90S-TCX	G54	32B-32FL-SS	H6
6G-6FFORX90S-TCX	G54		
6G-8FFORX90S-TCX	G54	Female DIN 24° Cone Swivel - Heavy Series with O-Ring	H7
8G-8FFORX90S-TCX	G54	4B-10FDHORX-SS	H7
8G-10FFORX90S-TCX	G54	6B-12FDHORX-SS	H7
10G-10FFORX90S-TCX	G54	8B-16FDHORX-SS	H7
12G-10FFORX90S-TCX	G54	12B-20FDHORX-SS	H7
12G-12FFORX90S-TCX	G54	16B-25FDHORX-SS	H7
16G-16FFORX90S-TCX	G54	16B-30FDHORX-SS	H7
20G-20FFORX90S-TCX	G54	20B-38FDHORX-SS	H7
		24B-38FDHORX-SS	H7
Code 61 O-Ring Flange	G54		
8G-8FL-TCX	G54	Non-Skive Ferrule	H7
12G-12FL-TCX	G55	4B1F-1SS	H7
12G-16FL-TCX	G55	6B1F-1SS	H7
16G-16FL-TCX	G55	4B1F-2SS	H7
		6B1F-2SS	H7
Code 61 O-Ring Flange - 90° Bent Tube	G55	8B1F-1SS	H7
12G-12FL90M-TCX	G55	10B1F-1SS	H7



Category	Page	Category	Page
<b>Stainless Steel Braid Couplings (Continued)</b>		<b>Power Crimp® Couplings (Continued)</b>	
Non-Skive Ferrule (Continued)	H7	Female Braze-On Stems (Continued)	16
12B1F-2SS	H7	12-16FBO	16
12B1F-1SS	H7	16-16FBO	17
16B1F-2SS	H7	20-20FBO	17
16B1F-3SS	H7	24-24FBO	17
20B1F-1SS	H7	Female DIN 24° Cone Swivel - Light Series	17
24B1F-2SS	H7	3C2-6FDLX	17
32B1F-2SS	H7	Female DIN 24° Cone Swivel - Light Series - 90° Bent Tube	17
24B1F-4SS	H7	3C2-6FDLX90	17
32B1F-4SS	H7		
<b>Power Crimp® Couplings</b>		Power Crimp® Two Ferrules (Steel) - PC2F Series	18
Male Pipe (NPTF - 30° Cone Seat)	I2	3PC2F-2	18
3-2MP	I2	4PC2F-2	18
3-4MP	I2	4PC2F-4	18
4-4MP	I2	5PC2F-2	18
5-4MP	I2	6PC2F-2	18
6-6MP	I2	6PC2F-4	18
6-8MP	I2	8PC2F-2	18
8-6MP	I2	8PC2F-4	18
8-8MP	I2	10PC2F-2B	18
12-12MP	I2	10PC2F-2C	18
16-16MP	I2	12PC2F-2	18
24-24MP	I2	12PC2F-4	18
32-32MP	I2	16PC2F-2	18
Male Special Grease Fitting	I2	16PC2F-4	18
3-2MPG	I2	20PC2F-2	18
3-2MPGB	I2	20PC2F-4	18
Male Pipe Swivel (NPTF - without 30° Cone Seat)	I3	24PC2F-4	18
3-2MPX	I3	32PC2F-4	18
8-8MPX	I3	Power Crimp® One Non-Skive Ferrules (Steel) - PC1FS Series	18
Female Pipe (NPTF - without 30° Cone Seat)	I3	3PC1FS	18
3-2FP	I3	4M3KPC	18
Male JIC 37° Flare	I3	4PC1F-M2S	18
3-4MJ	I3	4PC1FS	18
Female JIC 37° Flare Swivel	I4	5PC1FS	18
3-3FJX	I4	6M3KPC	18
3-4FJX	I4	6PC1F-M2S	18
4-4FJX	I4	6PC1FS	18
4-5FJX	I4	8M3KPC	18
4-6FJX	I4	8PC1F-M2S	18
5-5FJX	I4	8PC1FS	18
5-6FJX	I4	10PC1F-M2S	19
6-6FJX	I4	10PC1FS-M3K	19
6-8FJX	I4	12PC1F-M2S	19
8-8FJX	I4	12PC1FS-M3K	19
8-10FJX	I4	16PC1F-M2S	19
10-10FJX	I4	16PC1FS	19
10-12FJX	I4	20PC1FS	19
12-12FJX	I4	24PC1FS	19
16-16FJX	I4	32PC1FS	19
Female JIC 37° Flare Swivel - 45° Bent Tube	I4		
3C2-4FJX45S	I4	<b>Field Attachable Type T for G1 Hose (1 Wire)</b>	
Female JIC 37° Flare Swivel - 90° Bent Tube	I5	Male Pipe (NPTF - 30° Cone Seat)	J1
3C2-4FJX90S	I5	4C1T-2RMP	J1
24C2-24FJX90S	I5	4C1T-4RMP	J1
Female Flat-Face O-Ring Swivel	I5	6C1T-4RMP	J1
3C2-6FFORX	I5	6C1T-6RMP	J1
SAE Male Inverted Swivel	I5	8C1T-6RMP	J1
3C2-3MIX	I5	8C1T-8RMP	J1
SAE Male Inverted Swivel - 45° Bent Tube	I6	8C1T-12RMP	J1
3C2-3MIX45	I6	12C1T-12RMP	J1
SAE Male Inverted Swivel - 90° Bent Tube	I6	16C1T-16RMP	J1
3C2-3MIX90	I6	Male Pipe Swivel (NPTF - without 30° Cone Seat)	J1
Female Braze-On Stems	I6	4C1T-4RMPX	J1
3-4FBO	I6	6C1T-6RMPX	J1
4-4FBO	I6	8C1T-8RMPX	J1
4-5FBO	I6	12C1T-12RMPX	J1
6-6FBO	I6	Male O-Ring Boss	J2
6-8FBO	I6	6C1T-6RMB	J2
8-8FBO	I6	6C1T-8RMB	J2
8-10FBO	I6	8C1T-8RMB	J2
12-12FBO	I6	8C1T-10RMB	J2
		Male JIC 37° Flare	J2
		6C1T-6RMJ	J2
		8C1T-8RMJ	J2
		8C1T-10RMJ	J2
		12C1T-12RMJ	J2





Category	Page	Category	Page
<b>Field Attachable Type T for G1 Hose (1 Wire) (Continued)</b>		<b>Field Attachable Type T for G2 Hose (2 Wire) (Continued)</b>	
Female JIC 37° Flare Swivel	J2	Female Flat-Face O-Ring Swivel (Continued)	J7
4C1T-4RFJX	J2	6C2AT-6RFFORX	J7
4C1T-5RFJX	J2	8C2AT-8RFFORX	J7
6C1T-6RFJX	J2	12C2AT-12RFFORX	J7
6C1T-8RFJX	J2	Female Flat-Face O-Ring Swivel - 45° Bent Tube	J7
8C1T-8RFJX	J3	4C2AT-4RFFORX45S	J7
8C1T-10RFJX	J3	6C2AT-6RFFORX45S	J7
12C1T-12RFJX	J3	8C2AT-8RFFORX45S	J7
16C1T-16RFJX	J3	12C2AT-12RFFORX45S	J7
Female JIC 37° Flare Swivel - 45° Bent Tube	J3	Female Flat-Face O-Ring Swivel - 90° Bent Tube	J8
4C1T-4RFJX45	J3	4C2AT-4RFFORX90S	J8
6C1T-6RFJX45	J3	6C2AT-6RFFORX90S	J8
8C1T-8RFJX45	J3	8C2AT-8RFFORX90S	J8
12C1T-12RFJX45	J3	12C2AT-12RFFORX90S	J8
Female JIC 37° Flare Swivel - 90° Bent Tube	J3	<b>Field Attachable for C5CXH, C5C, C5D &amp; C5M Hose</b>	
4C1T-4RFJX90	J3	Male Pipe (NPTF - 30° Cone Seat) - Steel	K2
6C1T-6RFJX90	J3	4C5-2RMP	K2
6C1T-8RFJX90	J3	4C5-4RMP	K2
8C1T-8RFJX90	J3	5C5X-2RMP	K2
8C1T-10RFJX90	J3	5C5X-4RMP	K2
12C1T-12RFJX90	J3	6C5-4RMP	K2
<b>Field Attachable Type T for G2 Hose (2 Wire)</b>		6C5-6RMP	K2
Male Pipe (NPTF - 30° Cone Seat)	J4	8C5X-6RMP	K2
4C2AT-2RMP	J4	8C5X-8RMP	K2
4C2AT-4RMP	J4	10C5-8RMP	K2
6C2AT-4RMP	J4	10C5-12RMP	K2
6C2AT-6RMP	J4	12C5X-8RMP	K2
8C2AT-6RMP	J4	12C5X-12RMP	K2
8C2AT-8RMP	J4	16C5-12RMP	K2
8C2AT-12RMP	J4	16C5-16RMP	K2
12C2AT-12RMP	J4	20C5-20RMP	K2
16C2AT-16RMP	J4	24C5-24RMP	K2
20C2AT-20RMP	J4	32C5-32RMP	K2
24C2AT-24RMP	J4	Male Pipe (NPTF - 30° Cone Seat) - Brass	K2
Male Pipe Swivel (NPTF - without 30° Cone Seat)	J4	6C5-6RMPB	K2
4C2AT-4RMPX	J4	8C5-8RMPB	K2
6C2AT-6RMPX	J4	10C5-8RMPB	K2
8C2AT-8RMPX	J4	16C5-16RMPB	K2
12C2AT-12RMPX	J4	Male O-Ring Boss - Steel	K3
Male O-Ring Boss	J5	4C5-4RMB	K3
6C2AT-6RMB	J5	6C5-6RMB	K3
6C2AT-8RMB	J5	8C5X-8RMB	K3
8C2AT-8RMB	J5	Male JIC 37° Flare - Steel	K3
8C2AT-10RMB	J5	4C5-4RMJ	K3
Male JIC 37° Flare	J5	5C5X-5RMJ	K3
6C2AT-6RMJ	J5	6C5-6RMJ	K3
8C2AT-8RMJ	J5	8C5X-8RMJ	K3
8C2AT-10RMJ	J5	10C5-10RMJ	K3
12C2AT-12RMJ	J5	12C5X-12RMJ	K3
Female JIC 37° Flare Swivel	J5	16C5-16RMJ	K3
4C2AT-4RFJX	J5	Female JIC 37° Flare Swivel - Steel	K3
4C2AT-5RFJX	J5	6C5-6RFJX	K3
6C2AT-6RFJX	J5	8C5X-6RFJX	K3
6C2AT-8RFJX	J5	10C5-12RFJX	K4
8C2AT-8RFJX	J5	12C5X-12RFJX	K4
8C2AT-10RFJX	J5	16C5-16RFJX	K4
12C2AT-12RFJX	J6	20C5-20RFJX	K4
16C2AT-16RFJX	J6	24C5-24RFJX	K4
20C2AT-20RFJX	J6	32C5-32RFJX	K4
24C2AT-24RFJX	J6	Female JIC 37° Flare Swivel - Brass	K4
Female JIC 37° Flare Swivel - 45° Bent Tube	J6	6C5-6RFJXB	K4
4C2AT-4RFJX45	J6	12C5-12RFJXB	K4
6C2AT-6RFJX45	J6	16C5-16RFJXB	K4
8C2AT-8RFJX45	J6	Female JIC 37° Flare Swivel - 45° Bent Tube - Steel	K4
12C2AT-12RFJX45	J6	6C5-6RFJX45	K4
Female JIC 37° Flare Swivel - 90° Bent Tube	J6	12C5X-12RFJX45S	K4
4C2AT-4RFJX90	J6	16C5-16RFJX45	K4
6C2AT-6RFJX90	J6	Female JIC 37° Flare Swivel - 90° Bent Tube - Steel	K5
6C2AT-8RFJX90	J6	6C5-6RFJX90	K5
8C2AT-8RFJX90	J6	6C5-6RFJX90L	K5
8C2AT-10RFJX90	J6	12C5X-12RFJX90S	K5
12C2AT-12RFJX90	J6	12C5X-12RFJX90L	K5
Female Flat-Face O-Ring Swivel	J7	16C5-16RFJX90	K5
4C2AT-4RFFORX	J7	16C5-16RFJX90L	K5



Category Page

Field Attachable for C5CXH, C5C, C5D & C5M Hose (Continued)

Female JIC 37° Flare Swivel - 90° Bent Tube - Steel (Continued)	K5
20C5-20RFJX90S	K5
20C5-20RFJX90L	K5
Male SAE 45° Flare - Steel	K5
4C5-4RMS	K5
5C5X-5RMS	K5
6C5-6RMS	K5
8C5X-8RMS	K5
10C5-10RMS	K5
12C5X-12RMS	K5
Female SAE 45° Flare Swivel - Steel	K6
6C5-6RFSX	K6
10C5-12RFSX	K6
12C5X-12RFSX	K6
Female SAE 45° Flare Swivel - Brass	K6
6C5-6RFSXB	K6
12C5-12RFSXB	K6
Female SAE 45° Flare Swivel - 45° Bent Tube - Steel	K6
6C5-6RFSX45	K6
12C5X-12RFSX45S	K7
Female SAE 45° Flare Swivel - 90° Bent Tube - Steel	K7
6C5-6RFSX90	K7
6C5-6RFSX90L	K7
12C5X-12RFSX90S	K7
12C5X-12RFSX90L	K7
Dual Seat Female JIC 37°/SAE 45° Flare Swivel - Steel	K7
4C5-4RFJSX	K7
5C5X-4RFJSX	K7
5C5X-5RFJSX	K7
6C5-8RFJSX	K7
8C5X-8RFJSX	K7
10C5-8RFJSX	K7
10C5-10RFJSX	K7
Dual Seat Female JIC 37°/SAE 45° Flare Swivel - Brass	K8
5C5-5RFJSXB	K8
8C5-8RFJSXB	K8
10C5-10RFJSXB	K8
Dual Seat Female JIC 37°/SAE 45° Flare Swivel - 45° Bent Tube - Steel	K8
4C5-4RFJSX45	K8
5C5X-5RFJSX45S	K8
6C5-8RFJSX45	K8
8C5X-8RFJSX45S	K8
10C5-10RFJSX45	K8
Dual Seat Female JIC 37°/SAE 45° Flare Swivel - 90° Bent Tube - Steel	K9
4C5-4RFJSX90	K9
4C5-4RFJSX90L	K9
5C5X-5RFJSX90S	K9
5C5X-5RFJSX90L	K9
8C5X-8RFJSX90S	K9
8C5X-8RFJSX90L	K9
10C5-10RFJSX90	K9
10C5-10RFJSX90L	K9
Female Flat-Face Swivel - Steel	K9
4C5-4RFFORX	K9
6C5-6RFFORX	K9
8C5X-8RFFORX	K9
10C5-10RFFORX	K9
12C5X-12RFFORX	K9
Female Flat-Face Swivel - 45° Bent Tube - Steel	K10
4C5-4RFFORX45	K10
Female Flat-Face Swivel - 90° Bent Tube - Steel	K10
4C5-4RFFORX90	K10
6C5-6RFFORX90S	K10
Special Flange - 90° - Engine Oil Connection (Code 61 2-Bolt)	K11
20C5-20RFL90S	K11
Male SAE 45° Flare Inverted Swivel - Steel	K11
4C5-4RMIX	K11
5C5X-5RMIX	K11
5C5X-6RMIX	K11
6C5-5RMIX	K11
6C5-6RMIX	K11
6C5-8RMIX	K11
8C5X-6RMIX	K11

Category Page

Field Attachable for C5CXH, C5C, C5D & C5M Hose (Continued)

Male SAE 45° Flare Inverted Swivel - Steel (Continued)	K11
8C5X-8RMIX	K11
Male SAE 45° Flare Inverted Swivel - 45° Bent Tube - Steel	K12
4C5-4RMIX45	K12
6C5-6RMIX45	K12
8C5X-8RMIX45-028	K12
Male SAE 45° Flare Inverted Swivel - 90° Bent Tube - Steel	K12
4C5-4RMIX90	K12
5C5X-5RMIX90-042	K12
6C5-6RMIX90	K12
6C5-8RMIX90	K12
8C5X-6RMIX90-043	K12
8C5X-8RMIX90-045	K12
SAE Male Flareless Assembly - Steel	K13
4C5-4RMFA	K13
5C5X-5RMFA	K13
6C5-4RMFA	K13
6C5-6RMFA	K13
8C5X-8RMFA	K13
10C5-10RMFA	K13
Female Air Brake Swivel - Steel	K13
6C5-6RFABX	K13
8C5X-6RFABX	K13
Parker Triple Thread Female Swivel - Steel	K13
16C5-16RFZX	K13
<b>Field Attachable for C5E Hose</b>	
Male Pipe (NPTF - 30° Cone Seat) - Steel	K14
4C5E-2RMP	K14
4C5E-4RMP	K14
5C5E-4RMP	K14
6C5E-4RMP	K14
6C5E-6RMP	K14
8C5E-6RMP	K14
8C5E-8RMP	K14
10C5E-8RMP	K14
12C5E-12RMP	K14
12C5E-16RMP	K14
16C5E-12RMP	K14
16C5E-16RMP	K14
20C5E-20RMP	K14
Female JIC 37° Flare Swivel - Steel	K14
6C5E-6RFJX	K14
12C5E-12RFJX	K14
16C5E-16RFJX	K14
20C5E-20RFJX	K14
Female JIC 37° Flare Swivel - 45° Bent Tube - Steel	K15
6C5E-6RFJX45	K15
12C5E-12RFJX45	K15
Female JIC 37° Flare Swivel - 90° Bent Tube - Steel	K15
6C5E-6RFJX90	K15
12C5E-12RFJX90	K15
16C5E-16RFJX90	K15
20C5E-20RFJX90	K15
Female SAE 45° Flare Swivel - Steel	K16
6C5E-6RFSX	K16
12C5E-12RFSX	K16
Female SAE 45° Flare Swivel - 45° Bent Tube - Steel	K16
6C5E-6RFSX45	K16
12C5E-12RFSX45	K16
Female SAE 45° Flare Swivel - 90° Bent Tube - Steel	K17
6C5E-6RFSX90	K17
12C5E-12RFSX90	K17
Dual Seat Female JIC 37°/SAE 45° Flare Swivel - Steel	K17
4C5E-4RFJSX	K17
5C5E-5RFJSX	K17
8C5E-8RFJSX	K17
10C5E-10RFJSX	K17
Dual Seat Female JIC 37°/SAE 45° Flare Swivel - 45° Bent Tube - Steel	K18
4C5E-4RFJSX45	K18
8C5E-8RFJSX45	K18
10C5E-10RFJSX45	K18





Category	Page	Category	Page
<b>Field Attachable for C5E Hose (Continued)</b>		<b>C14 Couplings (Continued)</b>	
Dual Seat Female JIC 37°/SAE 45° Flare Swivel - 90° Bent Tube - Steel	K18	Female JIC 37° Flare Swivel - 45° Bent Tube - Steel	L4
4C5E-4RFJSX90	K18	4C14-4FJX45	L4
8C5E-8RFJSX90	K18	5C14-5FJX45	L5
10C5E-10RFJSX90	K18	6C14-6FJX45	L5
Special Flange - 90° - Engine Oil Connection (Code 61 2-Bolt) - Steel	K19	8C14-8FJX45	L5
20C5E-20RFL90S	K19	10C14-10FJX45	L5
Male SAE 45° Flare Inverted Swivel - Steel	K19	12C14-12FJX45	L5
4C5E-4RMIX	K19	16C14-16FJX45	L5
5C5E-5RMIX	K19	Female JIC 37° Flare Swivel - 90° Bent Tube - Steel	L5
6C5E-5RMIX	K19	4C14-4FJX90	L5
6C5E-6RMIX	K19	5C14-5FJX90	L5
8C5E-8RMIX	K19	6C14-6FJX90	L5
Male SAE 45° Flare Inverted Swivel - 45° Bent Tube - Steel	K20	8C14-8FJX90	L5
6C5E-6RMIX45	K20	10C14-10FJX90	L5
8C5E-8RMIX45	K20	12C14-12FJX90	L5
Male SAE 45° Flare Inverted Swivel - 90° Bent Tube - Steel	K20	16C14-16FJX90	L5
4C5E-4RMIX90	K20	Female SAE 45° Flare Swivel - Brass	L6
5C5E-5RMIX90	K20	6C14-6FSX-B	L6
6C5E-5RMIX90	K20	12C14-12FSX-B	L6
6C5E-6RMIX90	K20	Female SAE 45° Flare Swivel - 45° Bent Tube - Steel	L6
6C5E-6RMIX90	K20	4C14-4FSX45	L6
8C5E-8RMIX90	K20	5C14-5FSX45	L6
SAE Male Flareless Assembly - Steel	K21	6C14-6FSX45	L6
4C5E-4RMFA	K21	8C14-8FSX45	L6
5C5E-5RMFA	K21	10C14-10FSX45	L6
6C5E-4RMFA	K21	12C14-12FSX45	L6
6C5E-6RMFA	K21	Female SAE 45° Flare Swivel - 90° Bent Tube - Steel	L7
8C5E-8RMFA	K21	4C14-4FSX90	L7
10C5E-10RMFA	K21	5C14-5FSX90	L7
Parker Triple Thread Female Swivel - Steel	K21	6C14-6FSX90	L7
16C5E-16RFZX	K21	8C14-8FSX90	L7
		10C14-10FSX90	L7
		12C14-12FSX90	L7
<b>C14 Couplings</b>		Air Brake Compression - Brass	L7
Male Pipe (NPTF - 30° Cone Seat) - Stainless Steel	L2	8C14-8ABC-B	L7
4C14-2MP-SS	L2	10C14-10ABC-B	L7
4C14-4MP-SS	L2	12C14-12ABC-B	L7
5C14-4MP-SS	L2	Straight Tube Assembly - Brass	L8
6C14-4MP-SS	L2	10C14-8STA-B	L8
6C14-6MP-SS	L2	10C14-10STA-B	L8
8C14-6MP-SS	L2	12C14-12STA-B	L8
8C14-8MP-SS	L2	SAE Male Inverted Swivel - Steel	L8
10C14-8MP-SS	L2	4C14-4MIX	L8
12C14-12MP-SS	L2	5C14-5MIX	L8
16C14-16MP-SS	L2	6C14-6MIX	L8
Male Pipe (NPTF - 30° Cone Seat) - Brass	L2	8C14-8MIX	L8
4C14-2MP-B	L2	10C14-10MIX	L8
4C14-4MP-B	L2	SAE Male Inverted Swivel - 45° Bent Tube - Steel	L9
5C14-4MP-B	L2	4C14-4MIX45	L9
6C14-4MP-B	L2	6C14-6MIX45	L9
6C14-6MP-B	L2	8C14-8MIX45	L9
8C14-6MP-B	L2	10C14-10MIX45	L9
8C14-8MP-B	L2	12C14-12MIX45	L9
10C14-8MP-B	L2	SAE Male Inverted Swivel - 90° Bent Tube - Steel	L9
12C14-12MP-B	L2	4C14-4MIX90	L9
16C14-16MP-B	L2	5C14-5MIX90	L9
Dual Seat Female JIC 37°/SAE 45° Flare Swivel - Stainless Steel	L3	6C14-6MIX90	L9
4C14-4FJSX-SS	L3	8C14-8MIX90	L9
5C14-5FJSX-SS	L3	10C14-10MIX90	L9
8C14-8FJSX-SS	L3	12C14-12MIX90	L9
10C14-10FJSX-SS	L3	Two-Bolt Flange Swivel - Brass (Steel Flange) - Laundry Flange	L10
16C14-16FJSX-SS	L3	12C14-12TBFLX	L10
Dual Seat Female JIC 37°/SAE 45° Flare Swivel - Brass	L3	16C14-16TBFLX	L10
4C14-4FJSX-B	L3	C14 Assembly with Two Female Dual Seat JIC 37°/SAE 45° Flare Swivel (FJSX) Couplings-Steel	L10
5C14-5FJSX-B	L3	10C14-10FJSX-10FJSX-18	L10
8C14-8FJSX-B	L3	10C14-10FJSX-10FJSX-24	L10
10C14-10FJSX-B	L3	10C14-10FJSX-10FJSX-30	L10
16C14-16FJSX-B	L3	10C14-10FJSX-10FJSX-36	L10
Female JIC 37° Flare Swivel - Stainless Steel	L4	10C14-10FJSX-10FJSX-42	L10
6C14-6FJX-SS	L4	10C14-10FJSX-10FJSX-48	L10
12C14-12FJX-SS	L4	10C14-10FJSX-10FJSX-54	L10
Female JIC 37° Flare Swivel - Brass	L4	10C14-10FJSX-10FJSX-72	L10
6C14-6FJX-B	L4	10C14-10FJSX-10FJSX-84	L10
12C14-12FJX-B	L4		

# INDEX



Category Page

## C14 Couplings (Continued)

C14 Assembly with Two Air Brake Compression (ABC) Couplings - Steel	L10
10C14-10ABC-10ABC-18	L10
10C14-10ABC-10ABC-24	L10
C14 Assembly with Two Straight Tube Assembly (STA) Couplings - Steel	L11
10C14-10STA-10STA-24	L11
10C14-10STA-10STA-36	L11
12C14-12STA-12STA-24	L11
C14 One Straight Tube Assembly (STA) and One Air Brake Compression (ABC) Couplings - Steel	L11
10C14-10STA-10ABC-18	L11
10C14-10STA-10ABC-24	L11
10C14-10STA-10ABC-36	L11
10C14-10STA-10ABC-48	L11

## GL Couplings

Male Pipe (NPTF - 30° Cone Seat)	M2
12GL-12MP	M2
12GL-16MP	M2
16GL-16MP	M2
20GL-20MP	M2
24GL-24MP	M2
32GL-32MP	M2
Male Pipe Swivel (NPTF - without 30° Cone Seat)	M2
16GL-16MPX	M2
Female JIC 37° Flare Swivel	M2
12GL-12FJX	M2
12GL-14FJX	M3
12GL-16FJX	M3
16GL-16FJX	M3
20GL-20FJX	M3
24GL-20FJX	M3
24GL-24FJX	M3
32GL-32FJX	M3
40GL-40FJX	M3
Female JIC 37° Flare Swivel - 45° Bent Tube	M3
12GL-12FJX45S-021	M3
Female JIC 37° Flare Swivel - 90° Bent Tube	M3
12GL-12FJX90S	M3
16GL-16FJX90S	M3
20GL-20FJX90M	M3
24GL-20FJX90M	M3
24GL-20FJX90L	M3
24GL-24FJX90-092	M4
Female Flat-Face Swivel	M4
12GL-12FFORX	M4
16GL-16FFORX	M4
20GL-20FFORX	M4
24GL-24FFORX	M4
Female Flat-Face Swivel - 45° Bent Tube	M4
12GL-12FFORX45S	M4
16GL-16FFORX45S	M4
20GL-20FFORX45S	M4
Female Flat-Face Swivel - 90° Bent Tube	M5
12GL-12FFORX90S	M5
12GL-12FFORX90M	M5
16GL-16FFORX90S	M5
20GL-20FFORX90S	M5
24GL-24FFORX90M	M5
Code 61 O-Ring Flange	M5
12GL-12FL	M5
16GL-16FL	M5
20GL-20FL	M5
24GL-24FL	M5
32GL-32FL	M5
32GL-40FL	M5
40GL-40FL	M5
40GL-48FL	M5
40GL-56FL	M5
40GL-64FL	M5
48GL-48FL	M5
56GL-56FL	M5
64GL-64FL	M5
Code 61 O-Ring Flange - 22° Bent Tube	M6
24GL-24FL22M-018	M6

Category Page

## GL Couplings (Continued)

Code 61 O-Ring Flange - 22° Bent Tube (Continued)	M6
40GL-40FL22	M6
40GL-48FL22	M6
Code 61 O-Ring Flange - 30° Bent Tube	M6
12GL-12FL30M	M6
16GL-16FL30M	M6
20GL-20FL30M	M6
24GL-24FL30M	M6
32GL-32FL30M	M6
40GL-40FL30	M6
40GL-48FL30	M6
48GL-48FL30	M6
Code 61 O-Ring Flange - 45° Bent Tube	M7
12GL-12FL45M	M7
16GL-16FL45S	M7
20GL-20FL45S	M7
24GL-24FL45S	M7
32GL-32FL45S	M7
32GL-40FL45S	M7
40GL-40FL45	M7
40GL-48FL45	M7
48GL-48FL45	M7
56GL-56FL45	M7
56GL-64FL45	M7
64GL-64FL45	M7
Code 61 O-Ring Flange - 60° Bent Tube	M7
12GL-12FL60M	M7
16GL-16FL60M	M7
20GL-20FL60S	M7
24GL-24FL60S	M7
32GL-32FL60S	M7
40GL-40FL60	M7
48GL-48FL60	M7
Code 61 O-Ring Flange - 67 1/2° Bent Tube	M8
32GL-32FL67S	M8
40GL-40FL67	M8
48GL-48FL67	M8
64GL-64FL67	M8
Code 61 O-Ring Flange - 90° Bent Tube	M8
12GL-12FL90M	M8
12GL-16FL90S	M8
16GL-16FL90S	M8
16GL-20FL90S	M8
20GL-20FL90S	M8
20GL-24FL90-068	M8
24GL-24FL90S	M8
32GL-32FL90S	M8
32GL-40FL90-114	M8
40GL-40FL90	M8
40GL-48FL90	M8
48GL-48FL90	M8
56GL-56FL90	M8
56GL-64FL90	M8
64GL-64FL90	M8
Code 61 Captive O-Ring Flange	M9
56GL-56FLCF	M9
64GL-64FLCF	M9
Code 61 Captive O-Ring Flange - 45° Bent Tube	M9
56GL-56FLCF45-054	M9
Code 61 Captive O-Ring Flange - 90° Bent Tube	M10
56GL-56FLCF90-143	M10
<b>GLX® Couplings</b>	
Male Pipe (NPTF 30° Cone Seat)	N2
4GLX-2MP	N2
4GLX-4MP	N2
6GLX-4MP	N2
6GLX-6MP	N2
8GLX-6MP	N2
8GLX-8MP	N2
8GLX-12MP	N2
10GLX-8MP	N2
12GLX-8MP	N2
12GLX-12MP	N2
16GLX-16MP	N2



Category	Page	Category	Page
<b>GLX® Couplings (Continued)</b>		<b>PCTS Thermoplastic Couplings (One-Piece) (Continued)</b>	
Male Pipe (NPTF 30° Cone Seat) (Continued)		Dual Seat Female JIC 37°/SAE 45° Flare Swivel - 45° Bent Tube (Continued)	03
20GLX-20MP	N2	4PCTS-4FJSX	03
MPX Male NPTF Swivel	N2	5PCTS-5FJSX	03
4GLX-4MPX	N2		
6GLX-6MPX	N2	<b>PolarSeal® Couplings (ACA)</b>	
8GLX-8MPX	N2	Male SAE 45° Flare - Aluminum	P2
12GLX-12MPX	N2	6ACA-6MS	P2
16GLX-16MPX	N2	8ACA-8MS	P2
20GLX-20MPX	N2	10ACA-10MS	P2
FP Female NPTF	N3	12ACA-12MS	P2
4GLX-4FP	N3	Male SAE 45° Flare - 45° Bent Tube - Aluminum	P2
6GLX-4FP	N3	6ACA-6MS45	P2
6GLX-6FP	N3	8ACA-8MS45	P2
8GLX-6FP	N3	10ACA-10MS45	P2
8GLX-8FP	N3	12ACA-12MS45	P2
12GLX-12FP	N3	Male SAE 45° Flare - 90° Bent Tube - Aluminum	P2
16GLX-16FP	N3	6ACA-6MS90	P2
FPX Female NPSM Swivel	N3	8ACA-8MS90	P3
4GLX-4FPX	N3	10ACA-10MS90	P3
6GLX-4FPX	N3	12ACA-12MS90	P3
6GLX-6FPX	N3	Female SAE 45° Flare Swivel - Aluminum	P3
8GLX-6FPX	N3	6ACA-6FSX	P3
8GLX-8FPX	N3	6ACA-8FSX	P3
12GLX-12FPX	N3	8ACA-6FSX	P3
16GLX-16FPX	N3	8ACA-8FSX	P3
Female JIC 37° Flare Swivel	N4	10ACA-8FSX	P3
4GLX-4FJX	N4	10ACA-10FSX	P3
6GLX-6FJX	N4	12ACA-10FSX	P3
8GLX-8FJX	N4	12ACA-12FSX	P3
10GLX-10FJX	N4	Female SAE 45° Flare Swivel - Steel	P3
12GLX-12FJX	N4	6ACA-6FSX-S	P3
16GLX-16FJX	N4	8ACA-8FSX-S	P3
20GLX-20FJX	N4	10ACA-10FSX-S	P3
MS 45° SAE Male Solid	N4	Female SAE 45° Flare Swivel - 45° Bent Tube - Aluminum	P4
4GLX-4MS	N4	6ACA-6FSX45	P4
6GLX-6MS	N4	8ACA-6FSX45	P4
8GLX-8MS	N4	8ACA-8FSX45	P4
12GLX-12MS	N4	10ACA-10FSX45	P4
FSX 45° SAE Female Swivel	N5	12ACA-10FSX45	P4
4GLX-4FSX	N5	12ACA-12FSX45	P4
6GLX-6FSX	N5	Female SAE 45° Flare Swivel - 90° Bent Tube - Aluminum	P4
8GLX-8FSX	N5	6ACA-6FSX90	P4
12GLX-12FSX	N5	6ACA-8FSX90	P4
		8ACA-6FSX90	P4
<b>PCTS Thermoplastic Couplings (One-Piece)</b>		8ACA-8FSX90	P4
Male Pipe (NPTF - 30° Cone Seat)	02	10ACA-8FSX90	P4
2PCTS-2MP	02	10ACA-10FSX90	P4
2PCTS-4MP	02	12ACA-10FSX90	P4
3PCTS-2MP	02	12ACA-12FSX90	P4
3PCTS-4MP	02	Female SAE 45° Flare Swivel - 90° Bent Tube - Steel	P5
4PCTS-4MP	02	6ACA-6FSX90-S	P5
4PCTS-6MP	02	8ACA-8FSX90-S	P5
6PCTS-4MP	02	10ACA-10FSX90-S	P5
6PCTS-6MP	02	Male SAE Flareless Assembly - Aluminum	P5
6PCTS-8MP	02	6ACA-6MFA	P5
8PCTS-8MP	02	6ACA-8MFA	P5
Male Pipe Swivel (NPTF - without 30° Cone Seat)	02	8ACA-6MFA	P5
2PCTS-2MPX	02	8ACA-8MFA	P5
3PCTS-2MPX	02	8ACA-10MFA	P5
3PCTS-4MPX	02	10ACA-8MFA	P5
4PCTS-4MPX	02	10ACA-10MFA	P5
Female JIC 37° Flare Swivel	03	12ACA-10MFA	P5
2PCTS-3FJX	03	12ACA-12MFA	P5
4PCTS-6FJX	03	Male SAE Flareless Assembly - 90° Block - Aluminum	P6
8PCTS-12FJX	03	6ACA-6MFA90	P6
12PCTS-12FJX	03	6ACA-8MFA90	P6
16PCTS-16FJX	03	8ACA-6MFA90	P6
Female JIC 37° Flare Swivel - 90° Bent Tube	03	8ACA-8MFA90	P6
3PCTS-4FJX90S	03	8ACA-10MFA90	P6
6PCTS-6FJX90S	03	10ACA-8MFA90	P6
8PCTS-8FJX90L	03	10ACA-10MFA90	P6
Dual Seat Female JIC 37°/SAE 45° Flare Swivel - 45° Bent Tube	03	12ACA-10MFA90	P6
2PCTS-4FJSX	03	12ACA-12MFA90	P6
3PCTS-4FJSX	03		



Category	Page
<b>PolarSeal® Couplings (ACA) (Continued)</b>	
Female Braze-On Stems - Aluminum	P6
6ACA-6FBO	P6
8ACA-8FBO	P6
10ACA-10FBO	P6
12ACA-10FBO	P6
12ACA-12FBO	P6
Female Braze-On Stems - Steel	P7
6ACA-6FBO-S	P7
8ACA-8FBO-S	P7
10ACA-10FBO-S	P7
12ACA-10FBO-S	P7
12ACA-12FBO-S	P7
Hose Length Extender - Aluminum	P7
6ACA-6HLE	P7
6ACA-8HLE	P7
8ACA-8HLE	P7
8ACA-10HLE	P7
10ACA-10HLE	P7
12ACA-10HLE	P7
12ACA-12HLE	P7
Hose Length Extender - Steel	P7
12ACA-10HLE-S	P7
Hose Length Extender - 90° Bent Tube - Aluminum	P8
6ACA-6HLE90	P8
8ACA-8HLE90	P8
10ACA-10HLE90	P8
12ACA-12HLE90	P8
Hose Length Extender with Sight Glass - Aluminum	P8
6ACA-6HLESG	P8
Hose Length Extender - Tee - Aluminum	P9
6ACA-6HLET	P9
8ACA-8HLET	P9
10ACA-10HLET	P9
12ACA-10HLET	P9
12ACA-12HLET	P9
Hose Length Extender - 180° Bent Tube - Aluminum	P9
6ACA-6HLE180	P9
8ACA-8HLE180	P9
12ACA-12HLE180	P9
Male SAE Tube O-Ring Nut Swivel with R134a Service Port - Aluminum	P10
6ACA-6MTON134SP	P10
8ACA-8MTON134SP	P10
10ACA-10MTON134SP	P10
12ACA-12MTON134SP	P10
Male SAE Tube O-Ring Nut Swivel with R134a Service Port - 90° Bent Tube - Aluminum	P10
10ACA-10MTON134SP90	P10
Male SAE Tube O-Ring Nut Swivel - Aluminum	P11
6ACA-6MTON	P11
6ACA-7MTON	P11
6ACA-8MTON	P11
8ACA-6MTON	P11
8ACA-8MTON	P11
10ACA-10MTON	P11
12ACA-10MTON	P11
12ACA-12MTON	P11
Male SAE Tube O-Ring Nut Swivel - Steel	P11
6ACA-6MTON-S	P11
6ACA-7MTON-S	P11
10ACA-10MTON-S	P11
Male SAE Tube O-Ring Nut - 45° Bent Tube - Aluminum	P12
6ACA-6MTON45	P12
6ACA-8MTON45	P12
8ACA-6MTON45	P12
8ACA-8MTON45	P12
10ACA-10MTON45	P12
12ACA-12MTON45	P12
Male SAE Tube O-Ring Nut - 45° Bent Tube - Steel	P12
6ACA-6MTON45-S	P12
10ACA-10MTON45-S	P12
Male SAE Tube O-Ring Nut - 90° Bent Tube - Aluminum	P13
6ACA-6MTON90	P13
6ACA-7MTON90	P13
6ACA-8MTON90	P13

Category	Page
<b>PolarSeal® Couplings (ACA) (Continued)</b>	
Male SAE Tube O-Ring Nut - 90° Bent Tube - Aluminum (Continued)	P13
8ACA-6MTON90	P13
8ACA-8MTON90	P13
10ACA-10MTON90	P13
12ACA-10MTON90	P13
12ACA-12MTON90	P13
Male SAE Tube O-Ring Nut - 90° Bent Tube - Steel	P13
6ACA-6MTON90-S	P13
8ACA-8MTON90-S	P13
10ACA-10MTON90-S	P13
Female SAE Tube O-Ring Nut Swivel with R12 Service Port - Aluminum	P14
6ACA-6FTONR12SP	P14
8ACA-8FTONR12SP	P14
10ACA-10FTONR12SP	P14
Female SAE Tube O-Ring Nut Swivel with R12 Service Port - 90° Bent Tube - Aluminum	P14
6ACA-6FTONR12SP90	P14
8ACA-8FTONR12SP90	P14
10ACA-10FTONR12SP90	P14
12ACA-10FTONR12SP90	P14
Female SAE Tube O-Ring Nut Swivel with R134a Service Port - Aluminum	P15
6ACA-6FTON134SP	P15
8ACA-8FTON134SP	P15
10ACA-10FTON134SP	P15
12ACA-10FTON134SP	P15
Female SAE Tube O-Ring Nut Swivel with R134a Service Port - Steel	P15
6ACA-6FTON134SP-S	P15
8ACA-8FTON134SP-S	P15
10ACA-10FTON134SP-S	P15
Female SAE Tube O-Ring Nut Swivel with R134a Service Port - 90° Bent Tube - Aluminum	P16
6ACA-6FTON134SP90	P16
8ACA-8FTON134SP90	P16
10ACA-10FTON134SP90	P16
12ACA-10FTON134SP90	P16
Female SAE Tube O-Ring Nut Swivel with R134a Service Port - 90° Bent Tube - Steel	P16
6ACA-6FTON134SP90-S	P16
8ACA-8FTON134SP90-S	P16
10ACA-10FTON134SP90-S	P16
12ACA-10FTON134SP90-S	P16
Female SAE Tube O-Ring Nut Swivel - Aluminum	P17
6ACA-5FTON	P17
6ACA-6FTON	P17
6ACA-8FTON	P17
8ACA-6FTON	P17
8ACA-8FTON	P17
10ACA-8FTON	P17
10ACA-10FTON	P17
10ACA-12FTON	P17
12ACA-10FTON	P17
12ACA-12FTON	P17
Female SAE Tube O-Ring Nut Swivel - Steel	P17
6ACA-6FTON-S	P17
8ACA-8FTON-S	P17
10ACA-10FTON-S	P17
12ACA-10FTON-S	P17
12ACA-12FTON-S	P17
Female SAE Tube O-Ring Nut Swivel - 45° Bent Tube - Aluminum	P18
6ACA-6FTON45	P18
8ACA-6FTON45	P18
8ACA-8FTON45	P18
10ACA-8FTON45	P18
10ACA-10FTON45	P18
12ACA-10FTON45	P18
12ACA-12FTON45	P18
Female SAE Tube O-Ring Nut Swivel - 45° Bent Tube - Steel	P18
6ACA-6FTON45-S	P18
8ACA-8FTON45-S	P18
10ACA-10FTON45-S	P18
Female SAE Tube O-Ring Nut Swivel - 90° Bent Tube - Aluminum	P19
6ACA-5FTON90	P19
6ACA-6FTON90	P19
6ACA-8FTON90	P19
8ACA-6FTON90	P19
8ACA-8FTON90	P19
10ACA-8FTON90	P19



Category	Page	Category	Page
<b>PolarSeal® Couplings (ACA) (Continued)</b>		<b>PolarSeal® Couplings (ACA) (Continued)</b>	
Female SAE Tube O-Ring Nut Swivel - 90° Bent Tube - Aluminum (Continued)	P19	Female SAE Tube Dual O-Ring Nut - 45° Bent Tube - Aluminum (Continued)	P25
10ACA-10FTON90	P19	12ACA-12FTDON45	P25
10ACA-12FTON90	P19	Female SAE Tube Dual O-Ring Nut - 90° Bent Tube - Aluminum	P25
12ACA-10FTON90	P19	8ACA-8FTDON90	P25
12ACA-12FTON90	P19	10ACA-10FTDON90	P25
Female SAE Tube O-Ring Nut Swivel - 90° Bent Tube - Steel	P19	12ACA-12FTDON90	P25
6ACA-6FTON90-S	P19	Female SAE Tube Dual O-Ring Metric Nut - Aluminum	P25
8ACA-8FTON90-S	P19	8ACA-24FTDOMN	P25
10ACA-10FTON90-S	P19	10ACA-24FTDOMN	P26
12ACA-10FTON90-S	P19	12ACA-27FTDOMN	P26
Female SAE Tube O-Ring Metric Nut Swivel - Aluminum	P20	Female SAE Tube Dual O-Ring Metric Nut - 45° Bent Tube - Aluminum	P26
6ACA-16FTOMN	P20	8ACA-24FTDOMN45	P26
6ACA-18FTOMN	P20	10ACA-24FTDOMN45	P26
6ACA-20FTOMN	P20	12ACA-27FTDOMN45	P26
8ACA-20FTOMN	P20	Female SAE Tube Dual O-Ring Metric Nut - 90° Bent Tube - Aluminum	P26
10ACA-22FTOMN	P20	8ACA-24FTDOMN90	P26
10ACA-24FTOMN	P20	10ACA-24FTDOMN90	P26
12ACA-27FTOMN	P20	12ACA-27FTDOMN90	P26
Female SAE Tube O-Ring Metric Nut Swivel - 45° Bent Tube - Aluminum	P20	Female SAE Tube O-Ring Nut - 180° Bent Tube - Aluminum	P27
6ACA-14FTOMN45	P20	6ACA-6FTON180	P27
6ACA-16FTOMN45	P20	8ACA-8FTON180	P27
6ACA-18FTOMN45	P20	12ACA-12FTON180	P27
6ACA-20FTOMN45	P20	Male Inverted O-Ring with R134a Service Port - Aluminum	P27
8ACA-20FTOMN45	P20	6ACA-6MIO134SP	P27
10ACA-22FTOMN45	P20	8ACA-8MIO134SP	P27
10ACA-24FTOMN45	P20	10ACA-10MIO134SP	P27
12ACA-27FTOMN45	P20	12ACA-12MIO134SP	P27
Female SAE Tube O-Ring Metric Nut Swivel - 90° Bent Tube - Aluminum	P21	Male Inverted O-Ring with R134a Service Port - 90° Bent Tube - Aluminum	P28
6ACA-16FTOMN90	P21	6ACA-6MIO134SP90	P28
6ACA-18FTOMN90	P21	8ACA-8MIO134SP90	P28
6ACA-20FTOMN90	P21	10ACA-10MIO134SP90	P28
8ACA-20FTOMN90	P21	Universal Tee O-Ring Splicer English Threads - Aluminum	P28
10ACA-22FTOMN90	P21	6ACA-6TORSP	P28
10ACA-24FTOMN90	P21	6ACA-8TORSP	P28
12ACA-27FTOMN90	P21	10ACA-10TORSP	P28
Female SAE Tube O-Ring Nut Swivel - 90° Block - Steel	P21	10ACA-12TORSP	P28
8ACA-8FTON90BL-S	P21	Female SAE Tube O-Ring Nut Swivel with R134a High Pressure Service Port - Aluminum	P29
10ACA-10FTON90BL-S	P21	10ACA-10FTON134SPH	P29
12ACA-10FTON90BL-S	P21	Male Metric Flareless Assembly - Aluminum	P29
Male Inverted O-Ring - Aluminum	P22	6ACA-8MMFA	P29
6ACA-6MIO	P22	8ACA-12MMFA	P29
8ACA-8MIO	P22	10ACA-14.5MMFA	P29
10ACA-10MIO	P22	Female (Ford) Spring Lock Tee O-Ring Splicer - Aluminum	P29
12ACA-12MIO	P22	6ACA-8FSLTORSP	P29
Male Inverted O-Ring - Steel	P22	Female (Ford) Spring Lock Liquid Line Splicer - Aluminum	P30
6ACA-6MIO-S	P22	6ACA-8FSLSP	P30
8ACA-8MIO-S	P22	Male (Ford) Spring Lock - 45° Bent Tube - Aluminum	P30
10ACA-10MIO-S	P22	6ACA-6MSL45	P30
Male Inverted O-Ring - 45° Bent Tube - Aluminum	P22	6ACA-8MSL45	P30
6ACA-6MIO45	P22	8ACA-8MSL45	P30
8ACA-8MIO45	P22	10ACA-10MSL45	P30
10ACA-10MIO45	P22	12ACA-10MSL45	P30
Male Inverted O-Ring - 90° Bent Tube - Aluminum	P23	12ACA-12MSL45	P30
6ACA-6MIO90	P23	Male (Ford) Spring Lock - Aluminum	P30
8ACA-8MIO90	P23	6ACA-6MSL	P30
10ACA-10MIO90	P23	6ACA-8MSL	P30
Male Inverted O-Ring Bulkhead - Aluminum	P23	8ACA-8MSL	P31
6ACA-6MIOBKHD	P23	10ACA-10MSL	P31
8ACA-8MIOBKHD	P23	12ACA-10MSL	P31
10ACA-10MIOBKHD	P23	12ACA-12MSL	P31
Male Inverted O-Ring Bulkhead - Steel	P23	Male (Ford) Spring Lock - 90° Bent Tube - Aluminum	P31
6ACA-6MIOBKHD-S	P23	6ACA-6MSL90	P31
10ACA-10MIOBKHD-S	P23	6ACA-8MSL90	P31
Male Inverted O-Ring Bulkhead - 90° Bent Tube - Aluminum	P24	8ACA-8MSL90	P31
6ACA-6MIOBKHD90	P24	10ACA-10MSL90	P31
8ACA-8MIOBKHD90	P24	12ACA-10MSL90	P31
10ACA-10MIOBKHD90	P24	Female (Ford) Spring Lock - Aluminum	P31
Female SAE Tube Dual O-Ring Nut - Aluminum	P24	6ACA-6FSL	P31
8ACA-8FTDON	P24	6ACA-8FSL	P31
10ACA-10FTDON	P24	8ACA-8FSL	P31
12ACA-12FTDON	P24	10ACA-10FSL	P31
Female SAE Tube Dual O-Ring Nut - 45° Bent Tube - Aluminum	P25		
8ACA-8FTDON45	P25		



Category	Page	Category	Page
<b>PolarSeal® Couplings (ACA) (Continued)</b>		<b>PolarSeal® Couplings (ACA) (Continued)</b>	
Female (Ford) Spring Lock - Aluminum (Continued)	P31	Female Flareless Sleeve (Continued)	P38
12ACA-10FSL	P31	8ACFFS	P38
12ACA-12FSL	P31	10ACFFS	P38
		12ACFFS	P38
Female (Ford) Spring Lock - 90° Bent Tube - Aluminum	P32	Metric Female Flareless Sleeve	P39
6ACA-6FSL90	P32	8ACMFFS	P39
6ACA-8FSL90	P32	12ACMFFS	P39
8ACA-8FSL90	P32	14.5ACMFFS	P39
10ACA-10FSL90	P32	Accumulator/Compressor Sealing Washer	P39
12ACA-10FSL90	P32	10CPWTN	P39
12ACA-12FSL90	P32	10CPWTK	P39
Hose Splicer with R12 Thread Service Port - Aluminum	P32	12ACMW	P39
6ACA-R12SP	P32	12CPWTN	P39
8ACA-R12SP	P32	Valve Core	P39
10ACA-R12SP	P32	.210VC	P39
12ACA-R12SP	P32	Valve Cap for R12 Service Port	P40
Female (Ford) Spring Lock - 45° Bent Tube - Aluminum	P33	4R12CAP	P40
6ACA-6FSL45	P33	Red High Side Cap R134a Port	P40
6ACA-8FSL45	P33	8HS134CAP	P40
8ACA-8FSL45	P33	Blue Low Side Cap R134a Port	P40
10ACA-10FSL45	P33	8LS134CAP	P40
12ACA-10FSL45	P33	O-Ring for Switch	P41
12ACA-12FSL45	P33	6SWOR	P41
Hose Splicer with R134a Service Port - Aluminum	P33	O-Rings for PolarSeal® Couplings	P41
6ACA-R134SP	P33	6ACOR	P41
8ACA-R134SP	P33	8ACOR	P41
10ACA-R134SP	P33	10ACOR	P41
12ACA-R134SP	P33	12ACOR	P41
Hose Splicer with R134a Service Port - Steel	P34	O-Ring for Ford Spring Lock	P41
6ACA-R134SP-S	P34	6FSLOR	P41
8ACA-R134SP-S	P34	8FSLOR	P41
10ACA-R134SP-S	P34	10FSLOR	P41
12ACA-R134SP-S	P34	12FSLOR	P41
Female Rotalok (Compressor Connection) with R134a Service Port - 90° Block - Aluminum	P34	<b>PolarSeal® II Couplings (ACC)</b>	
8ACA-R134SP-RL	P34	Male Flareless Assembly	Q2
10ACA-R134SP-RL	P34	6ACC-6MFA	Q2
Compressor Female SAE Tube O-Ring Nut Swivel - 90° Bent Tube - Steel	P35	8ACC-8MFA	Q2
6ACA-6CFTON90-S	P35	10ACC-10MFA	Q2
8ACA-10CFTON90-S	P35	12ACC-12MFA	Q2
10ACA-10CFTON90-S	P35	Male Flareless Assembly - 90° Bent Tube	Q2
12ACA-10CFTON90-S	P35	6ACC-6MFA90	Q2
Compressor Female SAE Tube O-Ring Nut Swivel - 90° Block - Steel	P35	8ACC-8MFA90	Q2
8ACA-10CFTON90BL-S	P35	10ACC-10MFA90	Q2
12ACA-10CFTON90BL-S	P35	12ACC-12MFA90	Q2
Compressor Female Tube O-Ring Nut with 134a Service Port - 90° Block - Steel	P36	Weld On Hose End	Q2
8ACA-10CFTON134SP90BL-S	P36	6ACC-6FBO	Q2
10ACA-10CFTON134SP90BL-S	P36	8ACC-8FBO	Q2
12ACA-10CFTON134SP90BL-S	P36	10ACC-10FBO	Q2
Compressor Block - Single w/Switch or Service Port - 90° Bent Tube - Aluminum	P36	12ACC-10FBO	Q2
8ACA-8CBSR12SP90	P36	12ACC-12FBO	Q2
10ACA-8CBSR12SP90	P36	12ACC-16FBO	Q2
12ACA-8CBSR12SP90	P36	Splicer	Q3
Compressor Block - Single Reverse w/Switch or Service Port - 90° Bent Tube - Aluminum	P37	6ACC-6HLE	Q3
8ACA-8CBSRR12SP90	P37	8ACC-8HLE	Q3
10ACA-8CBSRR12SP90	P37	10ACC-10HLE	Q3
12ACA-8CBSRR12SP90	P37	12ACC-12HLE	Q3
R12 Ferrules	P37	T Splicer	Q3
6PCACF	P37	6ACC-6HLET	Q3
8PCACF	P37	8ACC-8HLET	Q3
10PCACF	P37	10ACC-10HLET	Q3
12PCACF	P37	12ACC-12HLET	Q3
Inline Orifice Tube	P37	Y Splicer	Q3
IOT-RED	P37	8ACC-8HLEY	Q3
IOT-WHITE	P37	10ACC-10HLEY	Q3
IOT-BLUE	P38	12ACC-12HLEY	Q3
IOT-BLACK	P38	Male O-Ring - 180° Bent Tube	Q4
Female Flareless Nut - Aluminum	P38	6ACC-6MTON180	Q4
6ACFFN	P38	10ACC-10MTON180	Q4
8ACFFN	P38	Male O-Ring with Switch or Service Port - 90° Bent Tube	Q4
10ACFFN	P38	8ACC-8MTON90134SWPH	Q4
12ACFFN	P38		
Female Flareless Sleeve	P38		
6ACFFS	P38		





Category	Page	Category	Page
<b>PolarSeal® II Couplings (ACC) (Continued)</b>		<b>PolarSeal® II Couplings (ACC) (Continued)</b>	
Male O-Ring	Q4	Female O-Ring - 90° Bent Tube (Continued)	Q10
6ACC-6MTON	Q4	8ACC-6FTON90	Q10
8ACC-6MTON	Q4	8ACC-8FTON90	Q10
8ACC-8MTON	Q4	8ACC-10FTON90	Q10
10ACC-10MTON	Q4	10ACC-8FTON90	Q10
12ACC-10MTON	Q4	10ACC-10FTON90	Q10
12ACC-12MTON	Q4	12ACC-10FTON90	Q10
16ACC-10MTON	Q4	12ACC-12FTON90	Q10
16ACC-12MTON	Q4	16ACC-10FTON90	Q10
		16ACC-12FTON90	Q10
Male O-Ring - 45° Bent Tube	Q5	Metric Female O-Ring	Q10
6ACC-6MTON45	Q5	8ACC-20FTOMN	Q10
12ACC-10MTON45	Q5	10ACC-27FTOMN	Q10
Male O-Ring - 90° Bent Tube	Q5	Metric Female O-Ring - 90° Bent Tube	Q11
6ACC-6MTON90	Q5	6ACC-18FTOMN90	Q11
8ACC-6MTON90	Q5	8ACC-20FTOMN90	Q11
8ACC-8MTON90	Q5	12ACC-27FTOMN90	Q11
10ACC-8MTON90	Q5	Male Insert O-Ring	Q11
10ACC-10MTON90	Q5	6ACC-6MIO	Q11
12ACC-10MTON90	Q5	8ACC-6MIO	Q11
12ACC-12MTON90	Q5	8ACC-8MIO	Q11
Straight Female O-Ring with R134 Service Port H	Q5	12ACC-10MIO	Q11
8ACC-8FTON134SPH	Q5	Male Insert O-Ring - 90° Bent Tube	Q11
10ACC-8FTON134SPH	Q6	6ACC-6MIO90	Q11
Straight Female O-Ring with R134 Service Port L	Q6	8ACC-6MIO90	Q11
10ACC-10FTON134SPL	Q6	8ACC-8MIO90	Q11
12ACC-10FTON134SPL	Q6	10ACC-8MIO90	Q11
12ACC-12FTON134SPL	Q6	10ACC-10MIO90	Q12
16ACC-10FTON134SPL	Q6	12ACC-10MIO90	Q12
Straight Female O-Ring with Switch Port M	Q6	Male Insert O-Ring Bulkhead	Q12
12ACC-10FTONMSWP	Q6	6ACC-6MIOBKHD	Q12
12ACC-12FTONMSWP	Q6	8ACC-8MIOBKHD	Q12
Straight Female O-Ring with Switch Port P	Q7	10ACC-10MIOBKHD	Q12
8ACC-8FTONSWP	Q7	12ACC-10MIOBKHD	Q12
12ACC-12FTONSWP	Q7	16ACC-12MIOBKHD	Q12
Female O-Ring with R134 Service Port H - 90° Bent Tube	Q7	Male Insert O-Ring Bulkhead - 90° Bent Tube	Q12
6ACC-8FTON134SPH90	Q7	6ACC-6MIOBKHD90	Q12
8ACC-8FTON134SPH90	Q7	8ACC-8MIOBKHD90	Q12
10ACC-8FTON134SPH90	Q7	10ACC-10MIOBKHD90	Q12
10ACC-10FTON134SPH90	Q7	12ACC-10MIOBKHD90	Q12
Female O-Ring with R134 Service Port L - 90° Bent Tube	Q7	Splicer with R134 Service Port H	Q13
10ACC-10FTON134SPL90	Q7	6ACC-6HLE134SPH	Q13
12ACC-10FTON134SPL90	Q8	8ACC-8HLE134SPH	Q13
Female O-Ring with Switch Port M - 90° Bent Tube	Q8	10ACC-10HLE134SPH	Q13
10ACC-10FTONMSWP90	Q8	Splicer with R134 Service Port L	Q13
12ACC-12FTONMSWP90	Q8	10ACC-10HLE134SPL	Q13
Female O-Ring with Switch Port P - 90° Bent Tube	Q8	12ACC-12HLE134SPL	Q13
8ACC-8FTONMSWP90	Q8	16ACC-16HLE134SPL	Q13
10ACC-8FTONMSWP90	Q8	Splicer with Switch Port M	Q13
12ACC-10FTONMSWP90	Q8	8ACC-8HLEMSWP	Q13
12ACC-12FTONMSWP90	Q8	10ACC-10HLEMSWP	Q13
Straight Female O-Ring	Q9	12ACC-12HLEMSWP	Q13
6ACC-6FTON	Q9	Splicer with Switch Port P	Q14
6ACC-8FTON	Q9	6ACC-6HLESWP	Q14
8ACC-6FTON	Q9	8ACC-8HLESWP	Q14
8ACC-8FTON	Q9	10ACC-10HLESWP	Q14
8ACC-10FTON	Q9	12ACC-12HLESWP	Q14
10ACC-8FTON	Q9	Metric Female O-Ring with Switch or Service Port - 90° Bent Tube	Q14
10ACC-10FTON	Q9	6ACC-10FTOMN90134SPH	Q14
12ACC-10FTON	Q9	Metric Male Insert O-Ring	Q14
12ACC-12FTON	Q9	10ACC-20MIOM	Q14
16ACC-10FTON	Q9	Clamp Assemblies	Q15
16ACC-12FTON	Q9	6CLAMP	Q15
Female O-Ring - 45° Bent Tube	Q9	8CLAMP	Q15
6ACC-6FTON45	Q9	10CLAMP	Q15
8ACC-8FTON45	Q9	12CLAMP	Q15
10ACC-8FTON45	Q9	16CLAMP	Q15
10ACC-10FTON45	Q9	<b>PolarSeal® II Couplings (ACB)</b>	
12ACC-10FTON45	Q9	Female SAE 45° Flare Swivel - Aluminum	R1
12ACC-12FTON45	Q9	6ACB-6FSX	R1
16ACC-12FTON45	Q9	6ACB-8FSX	R1
Female O-Ring - 90° Bent Tube	Q10		
6ACC-6FTON90	Q10		
6ACC-8FTON90	Q10		



Category Page  
**PolarSeal® II Couplings (ACB) (Continued)**

Female SAE 45° Flare Swivel - Aluminum (Continued)  
 8ACB-6FSX  
 8ACB-8FSX  
 10ACB-8FSX  
 10ACB-10FSX  
 12ACB-12FSX

Female SAE 45° Flare Swivel - Steel  
 6ACB-6FSX-S  
 8ACB-8FSX-S  
 12ACB-10FSX-S

Female SAE 45° Flare Swivel - 45° Bent Tube - Aluminum  
 6ACB-6FSX45  
 8ACB-8FSX45  
 10ACB-10FSX45  
 12ACB-12FSX45

Female SAE 45° Flare Swivel - 45° Bent Tube - Steel  
 10ACB-8FSX45-S

Female SAE 45° Flare Swivel - 90° Bent Tube - Aluminum  
 6ACB-6FSX90  
 8ACB-8FSX90  
 10ACB-10FSX90  
 12ACB-12FSX90

Female SAE 45° Flare Swivel - 90° Bent Tube - Steel  
 6ACB-6FSX90-S  
 8ACB-8FSX90-S  
 10ACB-8FSX90-S  
 10ACB-10FSX90-S  
 12ACB-10FSX90-S  
 12ACB-12FSX90-S

Male SAE Flareless Assembly - Steel  
 6ACB-6MFA-S  
 6ACB-8MFA-S  
 8ACB-6MFA-S  
 8ACB-8MFA-S  
 8ACB-10MFA-S  
 10ACB-8MFA-S  
 10ACB-10MFA-S  
 12ACB-10MFA-S  
 12ACB-12MFA-S

Male SAE Flareless Assembly - 90° Block - Steel  
 6ACB-6MFA90-S  
 6ACB-8MFA90-S  
 8ACB-8MFA90-S  
 8ACB-10MFA90-S  
 10ACB-8MFA90-S  
 10ACB-10MFA90-S  
 12ACB-10MFA90-S  
 12ACB-12MFA90-S

Female Braze-On Stems - Aluminum  
 6ACB-6FBO  
 8ACB-8FBO  
 10ACB-10FBO  
 12ACB-10FBO  
 12ACB-12FBO

Female Braze-On Stems - Steel  
 6ACB-6FBO-S  
 8ACB-8FBO-S  
 10ACB-10FBO-S  
 12ACB-10FBO-S  
 12ACB-12FBO-S

Hose Length Extender - Aluminum  
 6ACB-6HLE  
 6ACB-8HLE  
 8ACB-8HLE  
 8ACB-10HLE  
 10ACB-10HLE  
 12ACB-10HLE  
 12ACB-12HLE

Hose Length Extender - Steel  
 6ACB-6HLE-S  
 6ACB-8HLE-S  
 8ACB-8HLE-S  
 8ACB-10HLE-S

Category Page  
**PolarSeal® II Couplings (ACB) (Continued)**

R1 Hose Length Extender - Steel (Continued)  
 R1 10ACB-10HLE-S  
 R1 12ACB-10HLE-S  
 R1 12ACB-12HLE-S

R1 Hose Length Extender - 90° Bent Tube - Steel  
 R1 6ACB-6HLE90-S  
 R1 8ACB-8HLE90-S  
 R1 10ACB-10HLE90-S  
 R1 12ACB-12HLE90-S

R1 Hose Length Extender with Sight Glass - Steel  
 R1 6ACB-6HLESG-S

R1 Hose Length Extender - Tee - Aluminum  
 R1 6ACB-6HLET  
 R1 10ACB-10HLET  
 R1 12ACB-12HLET

R2 Hose Length Extender - Tee - Steel  
 R2 6ACB-6HLET-S  
 R2 8ACB-8HLET-S  
 R2 10ACB-10HLET-S  
 R2 12ACB-12HLET-S

R2 Female O-Ring with R134 Service Port - 45° Bent Tube - Aluminum  
 R2 8ACB-8FTON134SP45  
 R2 10ACB-10FTON134SP45

R2 Female O-Ring with R134 Service Port - 45° Bent Tube - Steel  
 R2 6ACB-6FTON134SP45-S  
 R2 8ACB-8FTON134SP45-S  
 R3 10ACB-10FTON134SP45-S  
 R3 12ACB-10FTON134SP45-S

R3 Female O-Ring with R12 Service Port - 45° Bent Tube - Steel  
 R3 6ACB-6FTONR12SP45-S  
 R3 8ACB-8FTONR12SP45-S  
 R3 10ACB-10FTONR12SP45-S

R3 Male SAE Tube O-Ring Nut Swivel with R134a Service Port - Steel  
 R3 6ACB-6MTON134SP-S  
 R3 10ACB-10MTON134SP-S

R3 Male SAE Tube O-Ring Nut Swivel with R134a Service Port - 90° Bent Tube - Steel  
 R3 10ACB-10MTON134SP90-S

R3 Male SAE Tube O-Ring Nut Swivel - Aluminum  
 R3 6ACB-6MTON  
 R3 8ACB-6MTON  
 R3 8ACB-8MTON  
 R3 10ACB-10MTON  
 R4 12ACB-10MTON  
 R4 12ACB-12MTON

R4 Male SAE Tube O-Ring Nut Swivel - Steel  
 R4 6ACB-6MTON-S  
 R4 6ACB-7MTON-S  
 R4 8ACB-6MTON-S  
 R4 8ACB-8MTON-S  
 R4 10ACB-8MTON-S  
 R4 10ACB-10MTON-S  
 R4 12ACB-10MTON-S  
 R4 12ACB-12MTON-S

R4 Male SAE Tube O-Ring Nut - 45° Bent Tube - Aluminum  
 R4 6ACB-6MTON45  
 R4 8ACB-8MTON45  
 R4 10ACB-10MTON45  
 R4 12ACB-12MTON45

R4 Male SAE Tube O-Ring Nut - 45° Bent Tube - Steel  
 R5 6ACB-6MTON45-S  
 R5 8ACB-6MTON45-S  
 R5 8ACB-8MTON45-S  
 R5 10ACB-10MTON45-S  
 R5 12ACB-12MTON45-S

R5 Male SAE Tube O-Ring Nut - 90° Bent Tube - Aluminum  
 R5 6ACB-6MTON90  
 R5 8ACB-6MTON90  
 R5 8ACB-8MTON90  
 R5 10ACB-10MTON90  
 R5 12ACB-10MTON90  
 R5 12ACB-12MTON90





Category	Page	Category	Page
<b>PolarSeal® II Couplings (ACB) (Continued)</b>		<b>PolarSeal® II Couplings (ACB) (Continued)</b>	
Male SAE Tube O-Ring Nut - 90° Bent Tube - Steel	R13	Female SAE Tube O-Ring Nut Swivel - 45° Bent Tube - Steel (Continued)	R19
6ACB-6MTON90-S	R13	10ACB-8FTON45-S	R19
6ACB-7MTON90-S	R13	10ACB-10FTON45-S	R19
8ACB-6MTON90-S	R13	12ACB-10FTON45-S	R19
8ACB-8MTON90-S	R13	12ACB-12FTON45-S	R19
10ACB-10MTON90-S	R13	Female SAE Tube O-Ring Nut Swivel - 90° Bent Tube - Aluminum	R19
12ACB-10MTON90-S	R13	6ACB-6FTON90	R19
12ACB-12MTON90-S	R13	6ACB-8FTON90	R19
Female SAE Tube O-Ring Nut Swivel with R12 Service Port - Aluminum	R13	8ACB-6FTON90	R19
8ACB-8FTONR12SP	R13	8ACB-8FTON90	R19
Female SAE Tube O-Ring Nut Swivel with R12 Service Port - Steel	R14	10ACB-8FTON90	R19
6ACB-6FTONR12SP-S	R14	10ACB-10FTON90	R19
8ACB-8FTONR12SP-S	R14	10ACB-12FTON90	R19
10ACB-10FTONR12SP-S	R14	12ACB-10FTON90	R19
Female SAE Tube O-Ring Nut Swivel with R12 Service Port - 90° Bent Tube - Aluminum	R14	12ACB-12FTON90	R19
6ACB-6FTONR12SP90	R14	Female SAE Tube O-Ring Nut Swivel - 90° Bent Tube - Steel	R20
Female SAE Tube O-Ring Nut Swivel with R12 Service Port - 90° Bent Tube - Steel	R15	6ACB-6FTON90-S	R20
6ACB-6FTONR12SP90-S	R15	6ACB-8FTON90-S	R20
8ACB-8FTONR12SP90-S	R15	8ACB-6FTON90-S	R20
10ACB-10FTONR12SP90-S	R15	8ACB-8FTON90-S	R20
12ACB-10FTONR12SP90-S	R15	10ACB-8FTON90-S	R20
Female SAE Tube O-Ring Nut Swivel with R134a Service Port - Aluminum	R15	10ACB-10FTON90-S	R20
6ACB-6FTON134SP	R15	10ACB-12FTON90-S	R20
8ACB-8FTON134SP	R15	12ACB-10FTON90-S	R20
10ACB-10FTON134SP	R15	12ACB-12FTON90-S	R20
12ACB-10FTON134SP	R15	Female SAE Tube O-Ring Metric Nut Swivel - Aluminum	R20
Female SAE Tube O-Ring Nut Swivel with R134a Service Port - Steel	R16	6ACB-20FTOMN	R20
6ACB-6FTON134SP-S	R16	8ACB-20FTOMN	R20
8ACB-8FTON134SP-S	R16	10ACB-22FTOMN	R20
10ACB-10FTON134SP-S	R16	Female SAE Tube O-Ring Metric Nut Swivel - Steel	R21
12ACB-10FTON134SP-S	R16	8ACB-20FTOMN-S	R21
12ACB-12FTON134SP-S	R16	12ACB-27FTOMN-S	R21
Female SAE Tube O-Ring Nut Swivel with R134a Service Port - 90° Bent Tube - Aluminum	R16	Female SAE Tube O-Ring Metric Nut Swivel - 45° Bent Tube - Aluminum	R21
6ACB-6FTON134SP90	R16	6ACB-18FTOMN45	R21
8ACB-8FTON134SP90	R16	6ACB-20FTOMN45	R21
10ACB-10FTON134SP90	R16	8ACB-20FTOMN45	R21
12ACB-10FTON134SP90	R16	12ACB-27FTOMN45	R21
Female SAE Tube O-Ring Nut Swivel with R134a Service Port - 90° Bent Tube - Steel	R17	Female SAE Tube O-Ring Metric Nut Swivel - 45° Bent Tube - Steel	R21
6ACB-6FTON134SP90-S	R17	8ACB-20FTOMN45-S	R21
8ACB-8FTON134SP90-S	R17	12ACB-27FTOMN45-S	R21
10ACB-10FTON134SP90-S	R17	Female SAE Tube O-Ring Metric Nut Swivel - 90° Bent Tube - Aluminum	R22
12ACB-10FTON134SP90-S	R17	6ACB-18FTOMN90	R22
Female SAE Tube O-Ring Nut Swivel - Aluminum	R17	8ACB-20FTOMN90	R22
6ACB-6FTON	R17	12ACB-27FTOMN90	R22
6ACB-8FTON	R17	Female SAE Tube O-Ring Metric Nut Swivel - 90° Bent Tube - Steel	R22
8ACB-6FTON	R17	8ACB-20FTOMN90-S	R22
8ACB-8FTON	R17	12ACB-27FTOMN90-S	R22
10ACB-8FTON	R17	Female SAE Tube O-Ring Nut Swivel - 90° Block - Steel	R23
10ACB-10FTON	R17	8ACB-8FTON90BL-S	R23
10ACB-12FTON	R17	10ACB-10FTON90BL-S	R23
12ACB-10FTON	R17	12ACB-10FTON90BL-S	R23
12ACB-12FTON	R17	Male Inverted O-Ring - Aluminum	R23
Female SAE Tube O-Ring Nut Swivel - Steel	R18	6ACB-6MIO	R23
6ACB-6FTON-S	R18	8ACB-8MIO	R23
6ACB-8FTON-S	R18	10ACB-10MIO	R23
8ACB-6FTON-S	R18	12ACB-12MIO	R23
8ACB-8FTON-S	R18	Male Inverted O-Ring - Steel	R23
10ACB-8FTON-S	R18	6ACB-6MIO-S	R23
10ACB-10FTON-S	R18	8ACB-8MIO-S	R23
10ACB-12FTON-S	R18	10ACB-10MIO-S	R23
12ACB-10FTON-S	R18	12ACB-12MIO-S	R23
12ACB-12FTON-S	R18	Male Inverted O-Ring - 45° Bent Tube - Aluminum	R24
Female SAE Tube O-Ring Nut Swivel - 45° Bent Tube - Aluminum	R18	6ACB-6MIO45	R24
6ACB-6FTON45	R18	8ACB-8MIO45	R24
8ACB-6FTON45	R18	10ACB-10MIO45	R24
8ACB-8FTON45	R18	Male Inverted O-Ring - 45° Bent Tube - Steel	R24
10ACB-8FTON45	R18	10ACB-10MIO45-S	R24
10ACB-10FTON45	R18	Male Inverted O-Ring - 90° Bent Tube - Aluminum	R24
12ACB-10FTON45	R18	6ACB-6MIO90	R24
12ACB-12FTON45	R18	8ACB-8MIO90	R24
Female SAE Tube O-Ring Nut Swivel - 45° Bent Tube - Steel	R19	10ACB-10MIO90	R24
6ACB-6FTON45-S	R19		
8ACB-6FTON45-S	R19		
8ACB-8FTON45-S	R19		



Category	Page	Category	Page
<b><u>PolarSeal® II Couplings (ACB) (Continued)</u></b>		<b><u>Power Steering Couplings (Continued)</u></b>	
Male Inverted O-Ring - 90° Bent Tube - Steel	R25	SAE Metric Male Flareless (includes Sleeve and Nut) (Continued)	S1
6ACB-6MIO90-S	R25	6PSM-12MFA	S1
8ACB-8MIO90-S	R25	<b><u>SAE to SAE Adapters</u></b>	
10ACB-10MIO90-S	R25	Male Pipe NPTF Plug	T1
Male Inverted O-Ring Bulkhead - Steel	R25	2MP-PLUG	T1
6ACB-6MIOBKHD-S	R25	4MP-PLUG	T1
8ACB-8MIOBKHD-S	R25	6MP-PLUG	T1
10ACB-10MIOBKHD-S	R25	8MP-PLUG	T1
Male Inverted O-Ring Bulkhead - 90° Bent Tube - Steel	R25	12MP-PLUG	T1
6ACB-6MIOBKHD90-S	R25	16MP-PLUG	T1
8ACB-8MIOBKHD90-S	R26	20MP-PLUG	T1
10ACB-10MIOBKHD90-S	R26	24MP-PLUG	T1
Female SAE Tube O-Ring Nut - 180° Bent Tube - Aluminum	R26	32MP-PLUG	T1
6ACB-6FTON180	R26	Male Pipe NPTF to Male Pipe NPTF	T1
8ACB-8FTON180	R26	2MP-2MP	T1
12ACB-12FTON180	R26	4MP-2MP	T1
Female SAE Tube O-Ring Nut - 180° Bent Tube - Steel	R26	4MP-4MP	T1
6ACB-6FTON180-S	R26	6MP-2MP	T1
10ACB-10FTON180-S	R26	6MP-4MP	T1
Universal Tee O-Ring Splicer English Threads - Aluminum	R27	6MP-6MP	T1
10ACB-10TORSP	R27	8MP-4MP	T1
Male (Ford) Spring Lock - 45° Bent Tube - Aluminum	R27	8MP-6MP	T1
6ACB-6MSL45	R27	8MP-8MP	T1
8ACB-8MSL45	R27	12MP-4MP	T1
10ACB-10MSL45	R27	12MP-6MP	T1
12ACB-12MSL45	R27	12MP-8MP	T1
Male (Ford) Spring Lock - Aluminum	R27	12MP-12MP	T1
6ACB-6MSL	R27	16MP-6MP	T1
8ACB-8MSL	R27	16MP-8MP	T1
10ACB-10MSL	R28	16MP-12MP	T1
Male (Ford) Spring Lock - 90° Bent Tube - Aluminum	R28	16MP-16MP	T1
6ACB-8MSL90	R28	20MP-12MP	T1
8ACB-8MSL90	R28	20MP-20MP	T1
10ACB-10MSL90	R28	24MP-12MP	T1
Female (Ford) Spring Lock - 90° Bent Tube - Aluminum	R28	24MP-16MP	T1
6ACB-6FSL90	R28	24MP-20MP	T2
10ACB-10FSL90	R28	24MP-24MP	T2
Hose Splicer with R12 Thread Service Port - Aluminum	R29	32MP-24MP	T2
6ACB-R12SP	R29	32MP-32MP	T2
10ACB-R12SP	R29	Male Pipe NPTF to Male Pipe NPTF - 90°	T2
12ACB-R12SP	R29	2MP-2MP90	T2
Hose Splicer with R12 Thread Service Port - Steel	R29	4MP-4MP90	T2
6ACB-R12SP-S	R29	6MP-4MP90	T2
8ACB-R12SP-S	R29	6MP-6MP90	T2
10ACB-R12SP-S	R29	8MP-4MP90	T2
Hose Splicer with R134a Service Port - Aluminum	R29	8MP-6MP90	T2
6ACB-R134SP	R29	8MP-8MP90	T2
8ACB-R134SP	R29	12MP-8MP90	T2
10ACB-R134SP	R29	12MP-12MP90	T2
12ACB-R134SP	R29	16MP-12MP90	T2
Hose Splicer with R134a Service Port - Steel	R30	16MP-16MP90	T2
6ACB-R134SP-S	R30	20MP-20MP90	T2
8ACB-R134SP-S	R30	24MP-24MP90	T2
10ACB-R134SP-S	R30	Male Pipe NPTF to Female Pipe NPTF Reducer Bushing - Short	T2
12ACB-R134SP-S	R30	4MP-2FPS	T2
Compressor Female SAE Tube O-Ring Nut Swivel - 90° Bent Tube - Steel	R30	6MP-2FPS	T2
6ACB-6CFTON90-S	R30	6MP-4FPS	T2
10ACB-10CFTON90-S	R30	8MP-2FPS	T2
Compressor Female Tube O-Ring Nut with 134a Service Port - 90° Block - Steel	R31	8MP-4FPS	T3
8ACB-10CFTON134SP90BL-S	R31	8MP-6FPS	T3
10ACB-10CFTON134SP90BL-S	R31	12MP-2FPS	T3
12ACB-10CFTON134SP90BL-S	R31	12MP-4FPS	T3
<b><u>Power Steering Couplings</u></b>		12MP-6FPS	T3
SAE Male Flareless (includes Sleeve and Nut)	S1	16MP-8FPS	T3
6PS-4MFA	S1	16MP-12FPS	T3
6PS-5MFA	S1	20MP-4FPS	T3
6PS-6MFA	S1	20MP-8FPS	T3
SAE Metric Male Flareless (includes Sleeve and Nut)	S1	20MP-12FPS	T3
6PSM-8MFA	S1	20MP-16FPS	T3
6PSM-10MFA	S1	24MP-12FPS	T3
		24MP-16FPS	T3
		24MP-20FPS	T3



Category	Page	Category	Page
<b>SAE to SAE Adapters (Continued)</b>		<b>SAE to SAE Adapters (Continued)</b>	
Male Pipe NPTF to Female Pipe NPTF Reducer Bushing - Short (Continued)	T3	Male Pipe NPTF to Female Pipe Swivel NPSM - 45°	T6
32MP-20FPS	T3	2MP-2FPX45	T6
32MP-24FPS	T3	2MP-4FPX45	T6
Male Pipe NPTF to Female Pipe NPTF Increasing Bushing - Long	T3	4MP-2FPX45	T6
2MP-4FPL	T3	4MP-4FPX45	T6
2MP-6FPL	T3	4MP-6FPX45	T6
4MP-2FPL	T3	6MP-4FPX45	T6
4MP-4FPL	T3	6MP-6FPX45	T6
4MP-6FPL	T3	6MP-8FPX45	T6
4MP-8FPL	T3	8MP-4FPX45	T6
6MP-4FPL	T3	8MP-6FPX45	T6
6MP-6FPL	T3	8MP-8FPX45	T6
6MP-8FPL	T3	8MP-12FPX45	T6
8MP-8FPL	T3	12MP-8FPX45	T6
8MP-12FPL	T3	12MP-12FPX45	T6
8MP-16FPL	T3	12MP-16FPX45	T6
12MP-8FPL	T3	16MP-12FPX45	T6
12MP-12FPL	T3	16MP-16FPX45	T6
12MP-16FPL	T3	16MP-20FPX45	T6
16MP-12FPL	T3	20MP-16FPX45	T6
16MP-16FPL	T3	20MP-20FPX45	T6
16MP-20FPL	T3	24MP-24FPX45	T6
16MP-24FPL	T3	32MP-32FPX45	T6
20MP-20FPL	T3	Male Pipe NPTF to Female Pipe Swivel NPSM - 90°	T6
20MP-24FPL	T4	2MP-2FPX90	T6
24MP-32FPL	T4	2MP-4FPX90	T6
Female Pipe NPTF to Male Pipe NPTF - 45°	T4	4MP-2FPX90	T6
6FP-6MP45	T4	4MP-4FPX90	T6
8FP-8MP45	T4	4MP-6FPX90	T6
Male Pipe NPTF to Female Pipe NPTF - 90°	T4	4MP-8FPX90	T7
2MP-2FP90	T4	6MP-4FPX90	T7
2MP-4FP90	T4	6MP-6FPX90	T7
4MP-2FP90	T4	6MP-8FPX90	T7
4MP-4FP90	T4	8MP-4FPX90	T7
4MP-6FP90	T4	8MP-6FPX90	T7
6MP-4FP90	T4	8MP-8FPX90	T7
6MP-6FP90	T4	8MP-12FPX90	T7
6MP-8FP90	T4	12MP-6FPX90	T7
8MP-4FP90	T4	12MP-8FPX90	T7
8MP-6FP90	T4	12MP-12FPX90	T7
8MP-8FP90	T4	12MP-16FPX90	T7
8MP-12FP90	T4	12MP-20FPX90	T7
12MP-8FP90	T4	16MP-8FPX90	T7
12MP-12FP90	T5	16MP-12FPX90	T7
12MP-16FP90	T5	16MP-16FPX90	T7
16MP-12FP90	T5	16MP-20FPX90	T7
16MP-16FP90	T5	20MP-12FPX90	T7
20MP-16FP90	T5	20MP-16FPX90	T7
20MP-20FP90	T5	20MP-20FPX90	T7
24MP-24FP90	T5	20MP-24FPX90	T7
32MP-32FP90	T5	24MP-20FPX90	T7
Male Pipe NPTF to Female Pipe Swivel NPSM	T5	24MP-24FPX90	T7
2MP-2FPX	T5	32MP-32FPX90	T7
2MP-4FPX	T5	Female Pipe NPTF to Female Pipe NPTF	T7
4MP-2FPX	T5	2FP-2FP	T7
4MP-4FPX	T5	4FP-2FP	T7
4MP-6FPX	T5	4FP-4FP	T7
4MP-8FPX	T5	6FP-2FP	T7
6MP-4FPX	T5	6FP-4FP	T7
6MP-6FPX	T5	6FP-6FP	T7
6MP-8FPX	T5	8FP-4FP	T7
8MP-6FPX	T5	8FP-6FP	T7
8MP-8FPX	T5	8FP-8FP	T7
8MP-12FPX	T5	12FP-8FP	T7
12MP-6FPX	T5	12FP-12FP	T7
12MP-8FPX	T5	16FP-8FP	T7
12MP-12FPX	T5	16FP-12FP	T7
12MP-16FPX	T5	16FP-16FP	T7
12MP-20FPX	T5	20FP-16FP	T7
16MP-12FPX	T5	20FP-20FP	T7
16MP-16FPX	T5	24FP-24FP	T8
16MP-20FPX	T5	32FP-32FP	T8
20MP-16FPX	T5	Female Pipe NPTF to Female Pipe NPTF - 90°	T8
20MP-20FPX	T5	2FP-2FP90	T8
20MP-24FPX	T5	4FP-2FP90	T8
24MP-20FPX	T5	4FP-4FP90	T8
24MP-24FPX	T5	6FP-4FP90	T8
32MP-32FPX	T5	6FP-6FP90	T8
		8FP-4FP90	T8



Category	Page	Category	Page
<u>SAE to SAE Adapters (Continued)</u>		<u>SAE to SAE Adapters (Continued)</u>	
Female Pipe NPTF to Female Pipe NPTF - 90° (Continued)	T8	Female Pipe NPTF on Run to Male Pipe NPTF - Tee (Continued)	T11
8FP-6FP90	T8	8FP-8FP-8MP	T11
8FP-8FP90	T8	12FP-12FP-12MP	T11
12FP-8FP90	T8	16FP-16FP-16MP	T11
12FP-12FP90	T8	20FP-20FP-20MP	T11
16FP-12FP90	T8	24FP-24FP-24MP	T11
16FP-16FP90	T8	Female Pipe Swivel NPSM - Tee	T11
20FP-20FP90	T8	2FPX-2FPX-2FPX	T11
24FP-24FP90	T8	4FPX-4FPX-4FPX	T11
32FP-32FP90	T8	6FPX-6FPX-6FPX	T11
Female Pipe NPTF to Female Pipe Swivel NPSM	T8	8FPX-8FPX-8FPX	T11
2FP-2FPX	T8	12FPX-12FPX-12FPX	T11
2FP-4FPX	T8	16FPX-16FPX-16FPX	T11
4FP-2FPX	T8	20FPX-20FPX-20FPX	T11
4FP-4FPX	T8	Female Pipe Swivel NPSM on Run to Male Pipe NPTF - Tee	T12
4FP-6FPX	T9	2FPX-2FPX-2MP	T12
6FP-4FPX	T9	4FPX-4FPX-4MP	T12
6FP-6FPX	T9	6FPX-6FPX-6MP	T12
6FP-8FPX	T9	8FPX-8FPX-8MP	T12
8FP-4FPX	T9	12FPX-12FPX-12MP	T12
8FP-6FPX	T9	16FPX-16FPX-16MP	T12
8FP-8FPX	T9	20FPX-20FPX-20MP	T12
8FP-12FPX	T9	24FPX-24FPX-24MP	T12
12FP-8FPX	T9	Male O-Ring Boss Plug	T12
12FP-12FPX	T9	2MB-PLUG	T12
12FP-16FPX	T9	3MB-PLUG	T12
16FP-12FPX	T9	4MB-PLUG	T12
16FP-16FPX	T9	5MB-PLUG	T12
20FP-20FPX	T9	6MB-PLUG	T12
24FP-24FPX	T9	8MB-PLUG	T12
32FP-32FPX	T9	10MB-PLUG	T12
Female Pipe NPTF to Female Pipe Swivel NPSM - 45°	T9	12MB-PLUG	T12
2FP-2FPX45	T9	14MB-PLUG	T12
2FP-4FPX45	T9	16MB-PLUG	T12
4FP-4FPX45	T9	20MB-PLUG	T12
6FP-4FPX45	T9	24MB-PLUG	T12
6FP-6FPX45	T9	32MB-PLUG	T12
6FP-8FPX45	T9	Male O-Ring Boss to Male Pipe NPTF	T13
8FP-6FPX45	T9	8MB-8MP	T13
8FP-8FPX45	T9	10MB-8MP	T13
12FP-12FPX45	T9	Male O-Ring Boss to Female Pipe NPTF	T13
16FP-12FPX45	T9	3MB-2FP	T13
16FP-16FPX45	T9	4MB-2FP	T13
20FP-20FPX45	T9	4MB-4FP	T13
Female Pipe NPTF to Female Pipe Swivel NPSM - 90°	T10	4MB-6FP	T13
2FP-2FPX90	T10	5MB-2FP	T13
2FP-4FPX90	T10	5MB-4FP	T13
4FP-2FPX90	T10	6MB-2FP	T13
4FP-4FPX90	T10	6MB-4FP	T13
4FP-6FPX90	T10	6MB-6FP	T13
6FP-4FPX90	T10	6MB-8FP	T13
6FP-6FPX90	T10	8MB-4FP	T13
6FP-8FPX90	T10	8MB-6FP	T13
8FP-6FPX90	T10	8MB-8FP	T13
8FP-8FPX90	T10	8MB-12FP	T13
8FP-12FPX90	T10	10MB-4FP	T13
12FP-8FPX90	T10	10MB-6FP	T13
12FP-12FPX90	T10	10MB-8FP	T13
16FP-12FPX90	T10	10MB-12FP	T13
16FP-16FPX90	T10	12MB-8FP	T13
20FP-16FPX90	T10	12MB-12FP	T13
20FP-20FPX90	T10	12MB-16FP	T13
24FP-24FPX90	T10	14MB-12FP	T13
32FP-32FPX90	T10	16MB-8FP	T13
Female Pipe NPTF - Tee	T10	16MB-12FP	T13
2FP-2FP-2FP	T10	16MB-16FP	T13
4FP-4FP-4FP	T10	20MB-16FP	T13
6FP-6FP-6FP	T10	Male O-Ring Boss to Female Pipe Swivel NPSM	T14
8FP-8FP-8FP	T10	4MB-2FPX	T14
12FP-12FP-12FP	T10	4MB-4FPX	T14
16FP-16FP-16FP	T10	4MB-6FPX	T14
20FP-20FP-20FP	T10	5MB-4FPX	T14
24FP-24FP-24FP	T11	5MB-8FPX	T14
32FP-32FP-32FP	T11	6MB-4FPX	T14
Female Pipe NPTF on Run to Male Pipe NPTF - Tee	T11	6MB-6FPX	T14
2FP-2FP-2MP	T11	6MB-8FPX	T14
4FP-4FP-4MP	T11	8MB-4FPX	T14
6FP-6FP-6MP	T11		



Category	Page	Category	Page
<u>SAE to SAE Adapters (Continued)</u>		<u>SAE to SAE Adapters (Continued)</u>	
Male O-Ring Boss to Female Pipe Swivel NPSM (Continued)	T14	Female O-Ring Boss to Male Pipe NPTF (Continued)	T16
8MB-6FPX	T14	12FB-12MP	T16
8MB-8FPX	T14	16FB-12MP	T16
8MB-12FPX	T14	16FB-16MP	T16
10MB-6FPX	T14		
10MB-8FPX	T14	Male O-Ring Boss to Male JIC 37° Flare	T17
10MB-12FPX	T14	2MB-2MJ	T17
12MB-8FPX	T14	2MB-4MJ	T17
12MB-12FPX	T14	3MB-4MJ	T17
12MB-16FPX	T14	4MB-3MJ	T17
14MB-12FPX	T14	4MB-4MJ	T17
16MB-12FPX	T14	4MB-5MJ	T17
16MB-16FPX	T14	4MB-6MJ	T17
16MB-20FPX	T14	4MB-8MJ	T17
20MB-12FPX	T14	5MB-3MJ	T17
20MB-16FPX	T14	5MB-4MJ	T17
20MB-20FPX	T14	5MB-5MJ	T17
24MB-20FPX	T14	5MB-6MJ	T17
24MB-24FPX	T14	6MB-4MJ	T17
32MB-32FPX	T14	6MB-5MJ	T17
		6MB-6MJ	T17
Male O-Ring Boss to Female Pipe Swivel NPSM - 45°	T15	6MB-8MJ	T17
4MB-2FPX45	T15	6MB-10MJ	T17
4MB-4FPX45	T15	6MB-12MJ	T17
4MB-6FPX45	T15	8MB-4MJ	T17
6MB-4FPX45	T15	8MB-5MJ	T17
6MB-6FPX45	T15	8MB-6MJ	T17
6MB-8FPX45	T15	8MB-8MJ	T17
8MB-4FPX45	T15	8MB-10MJ	T17
8MB-6FPX45	T15	8MB-12MJ	T17
8MB-8FPX45	T15	8MB-16MJ	T17
8MB-12FPX45	T15	10MB-4MJ	T17
10MB-6FPX45	T15	10MB-6MJ	T17
10MB-8FPX45	T15	10MB-8MJ	T17
10MB-12FPX45	T15	10MB-10MJ	T17
12MB-8FPX45	T15	10MB-12MJ	T17
12MB-12FPX45	T15	10MB-16MJ	T17
12MB-16FPX45	T15	12MB-4MJ	T17
16MB-12FPX45	T15	12MB-6MJ	T17
16MB-16FPX45	T15	12MB-8MJ	T17
20MB-20FPX45	T15	12MB-10MJ	T17
24MB-24FPX45	T15	12MB-12MJ	T17
		12MB-14MJ	T17
Male O-Ring Boss to Female Pipe Swivel NPSM - 90°	T15	12MB-16MJ	T17
4MB-2FPX90	T15	12MB-20MJ	T17
4MB-4FPX90	T15	14MB-10MJ	T17
4MB-6FPX90	T15	14MB-12MJ	T17
6MB-4FPX90	T15	14MB-14MJ	T17
6MB-6FPX90	T15	14MB-16MJ	T17
6MB-8FPX90	T15	16MB-8MJ	T17
8MB-4FPX90	T16	16MB-10MJ	T17
8MB-6FPX90	T16	16MB-12MJ	T17
8MB-8FPX90	T16	16MB-16MJ	T17
8MB-12FPX90	T16	16MB-20MJ	T17
10MB-6FPX90	T16	20MB-10MJ	T18
10MB-8FPX90	T16	20MB-12MJ	T18
10MB-12FPX90	T16	20MB-16MJ	T18
12MB-6FPX90	T16	20MB-20MJ	T18
12MB-8FPX90	T16	20MB-24MJ	T18
12MB-12FPX90	T16	24MB-16MJ	T18
12MB-16FPX90	T16	24MB-20MJ	T18
14MB-12FPX90	T16	24MB-24MJ	T18
16MB-12FPX90	T16	32MB-24MJ	T18
16MB-16FPX90	T16	32MB-32MJ	T18
16MB-20FPX90	T16		
20MB-12FPX90	T16	Male O-Ring Boss to Male JIC 37° Flare - 45°	T18
20MB-16FPX90	T16	4MB-4MJ45	T18
20MB-20FPX90	T16	4MB-6MJ45	T18
24MB-24FPX90	T16	5MB-5MJ45	T18
32MB-32FPX90	T16	5MB-6MJ45	T18
		6MB-4MJ45	T18
Female O-Ring Boss to Male Pipe NPTF	T16	6MB-6MJ45	T18
4FB-2MP	T16	6MB-8MJ45	T18
4FB-4MP	T16	8MB-6MJ45	T18
5FB-2MP	T16	8MB-8MJ45	T18
6FB-4MP	T16	8MB-10MJ45	T18
6FB-6MP	T16	8MB-12MJ45	T18
6FB-8MP	T16	10MB-8MJ45	T18
8FB-6MP	T16	10MB-10MJ45	T18
8FB-8MP	T16	10MB-12MJ45	T18
10FB-8MP	T16	12MB-10MJ45	T18
12FB-8MP	T16		



Category	Page	Category	Page
<u>SAE to SAE Adapters (Continued)</u>		<u>SAE to SAE Adapters (Continued)</u>	
Male O-Ring Boss to Male JIC 37° Flare - 45° (Continued)	T18	Male JIC 37° Flare on Run to Male O-Ring Boss - Tee (Continued)	T21
12MB-12MJ45	T18	14MJ-14MJ-14MB	T21
12MB-16MJ45	T18	16MJ-16MJ-16MB	T21
14MB-14MJ45	T18	20MJ-20MJ-20MB	T21
16MB-12MJ45	T18	24MJ-24MJ-24MB	T21
16MB-16MJ45	T18		
16MB-20MJ45	T18	Male O-Ring Boss to Male JIC 37° Flare to Male JIC 37° Flare - Tee	T21
20MB-16MJ45	T18	4MB-4MJ-4MJ	T21
20MB-20MJ45	T18	5MB-5MJ-5MJ	T21
24MB-24MJ45	T18	6MB-6MJ-6MJ	T21
		6MB-8MJ-6MJ	T21
		8MB-8MJ-8MJ	T21
Male O-Ring Boss to Male JIC 37° Flare - 90°	T19	10MB-10MJ-10MJ	T21
2MB-2MJ90	T19	12MB-12MJ-12MJ	T21
3MB-3MJ90	T19	12MB-12MJ-16MJ	T21
4MB-4MJ90	T19	14MB-14MJ-14MJ	T21
4MB-5MJ90	T19	16MB-16MJ-16MJ	T21
4MB-6MJ90	T19	20MB-20MJ-20MJ	T21
4MB-8MJ90	T19	24MB-24MJ-24MJ	T21
5MB-4MJ90	T19		
5MB-5MJ90	T19	Female JIC 37° Flare Cap	T22
5MB-6MJ90	T19	2FJ-CAP	T22
5MB-8MJ90	T19	3FJ-CAP	T22
6MB-4MJ90	T19	4FJ-CAP	T22
6MB-5MJ90	T19	5FJ-CAP	T22
6MB-6MJ90	T19	6FJ-CAP	T22
6MB-8MJ90	T19	8FJ-CAP	T22
6MB-10MJ90	T19	10FJ-CAP	T22
6MB-12MJ90	T19	12FJ-CAP	T22
8MB-4MJ90	T19	14FJ-CAP	T22
8MB-5MJ90	T19	16FJ-CAP	T22
8MB-6MJ90	T19	20FJ-CAP	T22
8MB-8MJ90	T19	24FJ-CAP	T22
8MB-10MJ90	T19	32FJ-CAP	T22
8MB-12MJ90	T19		
8MB-16MJ90	T19	Male JIC 37° Flare Plug	T22
10MB-5MJ90	T19	3MJ-PLUG	T22
10MB-6MJ90	T19	4MJ-PLUG	T22
10MB-8MJ90	T19	5MJ-PLUG	T22
10MB-10MJ90	T19	6MJ-PLUG	T22
10MB-12MJ90	T19	8MJ-PLUG	T22
10MB-16MJ90	T19	10MJ-PLUG	T22
12MB-6MJ90	T19	12MJ-PLUG	T22
12MB-8MJ90	T19	14MJ-PLUG	T22
12MB-10MJ90	T19	16MJ-PLUG	T22
12MB-12MJ90	T19	20MJ-PLUG	T22
12MB-14MJ90	T19	24MJ-PLUG	T22
12MB-16MJ90	T19	32MJ-PLUG	T22
12MB-20MJ90	T19		
14MB-12MJ90	T19	Male JIC 37° Flare to Female Braze - On	T23
14MB-14MJ90	T19	20MJ-20FBO	T23
14MB-16MJ90	T19		
14MB-20MJ90	T19	Male JIC 37° Flare to Male JIC 37° Flare	T23
16MB-8MJ90	T19	2MJ-2MJ	T23
16MB-10MJ90	T19	3MJ-2MJ	T23
16MB-12MJ90	T20	3MJ-3MJ	T23
16MB-14MJ90	T20	4MJ-3MJ	T23
16MB-16MJ90	T20	4MJ-4MJ	T23
16MB-20MJ90	T20	5MJ-4MJ	T23
16MB-24MJ90	T20	5MJ-5MJ	T23
20MB-10MJ90	T20	6MJ-4MJ	T23
20MB-12MJ90	T20	6MJ-5MJ	T23
20MB-16MJ90	T20	6MJ-6MJ	T23
20MB-20MJ90	T20	8MJ-4MJ	T23
20MB-24MJ90	T20	8MJ-5MJ	T23
24MB-20MJ90	T20	8MJ-6MJ	T23
24MB-24MJ90	T20	8MJ-8MJ	T23
32MB-32MJ90	T20	10MJ-4MJ	T23
		10MJ-6MJ	T23
		10MJ-8MJ	T23
Male O-Ring Boss to Female JIC 37° Flare Swivel	T20	10MJ-10MJ	T23
6MB-6FJX	T20	12MJ-4MJ	T23
8MB-8FJX	T20	12MJ-6MJ	T23
		12MJ-8MJ	T23
Male JIC 37° Flare on Run to Male O-Ring Boss - Tee	T20	12MJ-10MJ	T23
4MJ-4MJ-4MB	T20	12MJ-12MJ	T23
5MJ-5MJ-5MB	T20	14MJ-12MJ	T23
6MJ-6MJ-6MB	T20	14MJ-14MJ	T23
6MJ-6MJ-8MB	T21	16MJ-8MJ	T23
8MJ-8MJ-8MB	T21	16MJ-10MJ	T23
8MJ-8MJ-10MB	T21	16MJ-12MJ	T23
10MJ-10MJ-10MB	T21	16MJ-16MJ	T23
12MJ-12MJ-10MB	T21	20MJ-12MJ	T23
12MJ-12MJ-12MB	T21		





Category	Page	Category	Page
<b>SAE to SAE Adapters (Continued)</b>		<b>SAE to SAE Adapters (Continued)</b>	
Male JIC 37° Flare to Male JIC 37° Flare (Continued)	T24	Male JIC 37° Flare to Male JIC 37° Flare Bulkhead (Continued)	T27
20MJ-16MJ	T24	4MJ-4BKHD	T27
20MJ-20MJ	T24	5MJ-5BKHD	T27
24MJ-12MJ	T24	6MJ-6BKHD	T27
24MJ-20MJ	T24	8MJ-8BKHD	T27
24MJ-24MJ	T24	10MJ-10BKHD	T27
32MJ-32MJ	T24	12MJ-12BKHD	T27
		14MJ-14BKHD	T27
Male JIC 37° Flare to Male JIC 37° Flare - 90°	T24	16MJ-16BKHD	T27
2MJ-2MJ90	T24	20MJ-20BKHD	T27
4MJ-4MJ90	T24	24MJ-24BKHD	T27
5MJ-5MJ90	T24		
6MJ-4MJ90	T24	Male JIC 37° Flare to Male JIC 37° Flare Bulkhead - 45°	T27
6MJ-6MJ90	T24	4MJ-4BKHD45	T27
8MJ-6MJ90	T24	5MJ-5BKHD45	T27
8MJ-8MJ90	T24	6MJ-6BKHD45	T27
10MJ-10MJ90	T24	8MJ-8BKHD45	T27
12MJ-12MJ90	T24	10MJ-10BKHD45	T27
14MJ-14MJ90	T24	12MJ-12BKHD45	T27
16MJ-12MJ90	T24	16MJ-16BKHD45	T27
16MJ-16MJ90	T24		
20MJ-20MJ90	T24	Male JIC 37° Flare to Male JIC 37° Flare Bulkhead - 90°	T28
24MJ-24MJ90	T24	4MJ-4BKHD90	T28
32MJ-32MJ90	T24	5MJ-5BKHD90	T28
		6MJ-6BKHD90	T28
Male JIC 37° Flare to Female JIC 37° Flare	T25	8MJ-8BKHD90	T28
4MJ-6FJ	T25	10MJ-10BKHD90	T28
5MJ-4FJ	T25	12MJ-12BKHD90	T28
5MJ-6FJ	T25	14MJ-14BKHD90	T28
6MJ-4FJ	T25	16MJ-16BKHD90	T28
6MJ-6FJ	T25	20MJ-20BKHD90	T28
6MJ-8FJ	T25	24MJ-24BKHD90	T28
6MJ-10FJ	T25		
8MJ-4FJ	T25	Male JIC 37° Flare Tee	T28
8MJ-8FJ	T25	2MJ-2MJ-2MJ	T28
8MJ-10FJ	T25	3MJ-3MJ-3MJ	T28
8MJ-12FJ	T25	4MJ-4MJ-4MJ	T28
10MJ-4FJ	T25	5MJ-5MJ-5MJ	T28
10MJ-6FJ	T25	6MJ-6MJ-6MJ	T28
10MJ-8FJ	T25	6MJ-6MJ-8MJ	T28
10MJ-12FJ	T25	8MJ-8MJ-8MJ	T28
10MJ-16FJ	T25	10MJ-10MJ-10MJ	T28
12MJ-4FJ	T25	12MJ-12MJ-12MJ	T28
12MJ-6FJ	T25	14MJ-14MJ-14MJ	T29
12MJ-8FJ	T25	16MJ-16MJ-12MJ	T29
12MJ-12FJ	T25	16MJ-16MJ-16MJ	T29
12MJ-16FJ	T25	20MJ-20MJ-20MJ	T29
12MJ-20FJ	T25	24MJ-24MJ-24MJ	T29
16MJ-16FJ	T25	32MJ-32MJ-32MJ	T29
16MJ-20FJ	T25		
20MJ-16FJ	T25	Male JIC 37° Flare on Run to Female JIC 37° Flare Swivel - Tee	T29
		4MJ-4MJ-4FJX	T29
Male JIC 37° Flare to Female JIC 37° Flare Swivel - 90°	T25	5MJ-5MJ-5FJX	T29
4MJ-4FJX90	T25	6MJ-6MJ-6FJX	T29
5MJ-5FJX90	T26	8MJ-8MJ-8FJX	T29
6MJ-4FJX90	T26	10MJ-10MJ-10FJX	T29
6MJ-6FJX90	T26	12MJ-12MJ-12FJX	T29
8MJ-6FJX90	T26	14MJ-14MJ-14FJX	T29
8MJ-8FJX90	T26	16MJ-16MJ-16FJX	T29
8MJ-10FJX90	T26	20MJ-20MJ-20FJX	T29
10MJ-10FJX90	T26	24MJ-24MJ-24FJX	T29
12MJ-12FJX90	T26	32MJ-32MJ-32FJX	T29
14MJ-14FJX90	T26		
16MJ-16FJX90	T26	Male JIC 37° Flare on Run to Male JIC 37° Flare Bulkhead - Tee	T30
20MJ-20FJX90	T26	4MJ-4MJ-4BKHD	T30
24MJ-24FJX90	T26	5MJ-5MJ-5BKHD	T30
32MJ-32FJX90	T26	6MJ-6MJ-6BKHD	T30
		8MJ-8MJ-8BKHD	T30
Male JIC 37° Flare to Female JIC 37° Flare Swivel - 45°	T26	10MJ-10MJ-10BKHD	T30
4MJ-4FJX45	T26	12MJ-12MJ-12BKHD	T30
5MJ-5FJX45	T26	16MJ-16MJ-16BKHD	T30
6MJ-6FJX45	T26		
8MJ-8FJX45	T26	Male JIC 37° Flare to Male JIC 37° Flare Bulkhead to Male JIC 37° Flare - Tee	T30
10MJ-10FJX45	T26	4MJ-4BKHD-4MJ	T30
12MJ-12FJX45	T26	6MJ-6BKHD-6MJ	T30
14MJ-14FJX45	T26	8MJ-8BKHD-8MJ	T30
16MJ-16FJX45	T26	10MJ-10BKHD-10MJ	T30
20MJ-20FJX45	T26	12MJ-12BKHD-12MJ	T30
24MJ-24FJX45	T26	16MJ-16BKHD-16MJ	T30
32MJ-32FJX45	T26		
		Male JIC 37° Flare to Female JIC 37° Flare Swivel to Male JIC 37° Flare - Tee	T31
Male JIC 37° Flare to Male JIC 37° Flare Bulkhead	T27	4MJ-4FJX-4MJ	T31
3MJ-3BKHD	T27	5MJ-5FJX-5MJ	T31



Category	Page	Category	Page
<b>SAE to SAE Adapters (Continued)</b>		<b>SAE to SAE Adapters (Continued)</b>	
Male JIC 37° Flare to Female JIC 37° Flare Swivel to Male JIC 37° Flare - Tee (Continued)	T31	Male JIC 37° Flare to Male Pipe NPTF - 45° (Continued)	T33
6MJ-6FJX-6MJ	T31	8MJ-8MP45	T33
8MJ-8FJX-8MJ	T31	8MJ-12MP45	T33
10MJ-10FJX-10MJ	T31	10MJ-6MP45	T33
12MJ-12FJX-12MJ	T31	10MJ-8MP45	T33
14MJ-14FJX-14MJ	T31	10MJ-12MP45	T33
16MJ-16FJX-16MJ	T31	12MJ-8MP45	T33
20MJ-20FJX-20MJ	T31	12MJ-12MP45	T33
24MJ-24FJX-24MJ	T31	12MJ-16MP45	T33
32MJ-32FJX-32MJ	T31	14MJ-12MP45	T33
		16MJ-8MP45	T33
Male JIC 37° Flare to Male Pipe NPTF	T31	16MJ-12MP45	T33
2MJ-2MP	T31	16MJ-16MP45	T33
3MJ-2MP	T31	16MJ-20MP45	T33
4MJ-2MP	T31	20MJ-16MP45	T33
4MJ-4MP	T31	20MJ-20MP45	T33
4MJ-6MP	T31	20MJ-24MP45	T33
4MJ-8MP	T31	24MJ-24MP45	T33
4MJ-12MP	T31	32MJ-32MP45	T33
5MJ-2MP	T31		
5MJ-4MP	T31	Male JIC 37° Flare to Male Pipe NPTF - 90°	T34
5MJ-6MP	T31	2MJ-2MP90	T34
5MJ-8MP	T31	3MJ-2MP90	T34
6MJ-2MP	T32	4MJ-2MP90	T34
6MJ-4MP	T32	4MJ-4MP90	T34
6MJ-6MP	T32	4MJ-6MP90	T34
6MJ-8MP	T32	4MJ-8MP90	T34
6MJ-12MP	T32	4MJ-12MP90	T34
8MJ-2MP	T32	5MJ-2MP90	T34
8MJ-4MP	T32	5MJ-4MP90	T34
8MJ-6MP	T32	5MJ-6MP90	T34
8MJ-8MP	T32	6MJ-2MP90	T34
8MJ-12MP	T32	6MJ-4MP90	T34
8MJ-16MP	T32	6MJ-6MP90	T34
10MJ-4MP	T32	6MJ-8MP90	T34
10MJ-6MP	T32	6MJ-12MP90	T34
10MJ-8MP	T32	8MJ-4MP90	T34
10MJ-12MP	T32	8MJ-6MP90	T34
12MJ-6MP	T32	8MJ-8MP90	T34
12MJ-8MP	T32	8MJ-12MP90	T34
12MJ-12MP	T32	8MJ-16MP90	T34
12MJ-16MP	T32	10MJ-6MP90	T34
12MJ-20MP	T32	10MJ-8MP90	T34
12MJ-24MP	T32	10MJ-12MP90	T34
14MJ-12MP	T32	10MJ-16MP90	T34
14MJ-16MP	T32	12MJ-6MP90	T34
16MJ-8MP	T32	12MJ-8MP90	T34
16MJ-12MP	T32	12MJ-12MP90	T34
16MJ-16MP	T32	12MJ-16MP90	T34
16MJ-20MP	T32	12MJ-20MP90	T34
16MJ-24MP	T32	14MJ-8MP90	T34
20MJ-12MP	T32	14MJ-12MP90	T34
20MJ-16MP	T32	16MJ-8MP90	T34
20MJ-20MP	T32	16MJ-12MP90	T34
20MJ-24MP	T32	16MJ-16MP90	T34
24MJ-16MP	T32	16MJ-20MP90	T34
24MJ-20MP	T32	16MJ-24MP90	T34
24MJ-24MP	T32	20MJ-16MP90	T34
24MJ-32MP	T32	20MJ-20MP90	T34
32MJ-16MP	T32	20MJ-24MP90	T34
32MJ-20MP	T32	24MJ-20MP90	T34
32MJ-24MP	T32	24MJ-24MP90	T34
32MJ-32MP	T32	32MJ-24MP90	T34
		32MJ-32MP90	T34
Male JIC 37° Flare to Male Pipe NPTF - 45°	T33		
2MJ-2MP45	T33	Male JIC 37° Flare to Female Pipe NPTF	T35
3MJ-2MP45	T33	2MJ-2FP	T35
4MJ-2MP45	T33	3MJ-2FP	T35
4MJ-4MP45	T33	3MJ-4FP	T35
4MJ-6MP45	T33	4MJ-2FP	T35
4MJ-8MP45	T33	4MJ-4FP	T35
5MJ-2MP45	T33	4MJ-6FP	T35
5MJ-4MP45	T33	4MJ-8FP	T35
5MJ-6MP45	T33	5MJ-2FP	T35
6MJ-2MP45	T33	5MJ-4FP	T35
6MJ-4MP45	T33	6MJ-2FP	T35
6MJ-6MP45	T33	6MJ-4FP	T35
6MJ-8MP45	T33	6MJ-6FP	T35
6MJ-12MP45	T33	6MJ-8FP	T35
8MJ-4MP45	T33	8MJ-4FP	T35
8MJ-6MP45	T33	8MJ-6FP	T35





Category	Page	Category	Page
<b>SAE to SAE Adapters (Continued)</b>		<b>SAE to SAE Adapters (Continued)</b>	
Male JIC 37° Flare to Female Pipe NPTF (Continued)	T35	Male JIC 37° Flare Bulkhead to Male Pipe NPTF (Continued)	T38
8MJ-8FP	T35	12MJBKHD-12MP	T38
8MJ-12FP	T35	16MJBKHD-16MP	T38
10MJ-6FP	T35	20MJBKHD-20MP	T38
10MJ-8FP	T35	Male JIC 37° Flare on Run to Male Pipe NPTF - Tee	T38
10MJ-12FP	T35	3MJ-3MJ-2MP	T38
12MJ-8FP	T35	4MJ-4MJ-2MP	T38
12MJ-12FP	T35	4MJ-4MJ-4MP	T38
12MJ-16FP	T35	4MJ-4MJ-6MP	T38
14MJ-12FP	T35	5MJ-5MJ-2MP	T38
16MJ-12FP	T35	5MJ-5MJ-4MP	T38
16MJ-16FP	T35	6MJ-6MJ-4MP	T38
16MJ-20FP	T35	6MJ-6MJ-6MP	T38
20MJ-16FP	T35	6MJ-6MJ-8MP	T38
20MJ-20FP	T35	8MJ-8MJ-6MP	T38
24MJ-24FP	T35	8MJ-8MJ-8MP	T38
32MJ-32FP	T35	8MJ-8MJ-12MP	T38
Male JIC 37° Flare to Female Pipe NPTF - 90°	T36	10MJ-10MJ-8MP	T38
4MJ-2FP90	T36	12MJ-12MJ-8MP	T38
4MJ-4FP90	T36	12MJ-12MJ-12MP	T38
5MJ-2FP90	T36	12MJ-12MJ-16MP	T38
5MJ-4FP90	T36	14MJ-14MJ-12MP	T38
6MJ-2FP90	T36	16MJ-16MJ-12MP	T38
6MJ-4FP90	T36	16MJ-16MJ-16MP	T39
6MJ-6FP90	T36	20MJ-20MJ-20MP	T39
6MJ-8FP90	T36	24MJ-24MJ-24MP	T39
8MJ-4FP90	T36	Female Flat-Face O-Ring Cap	T39
8MJ-6FP90	T36	4FFOR-CAP	T39
8MJ-8FP90	T36	6FFOR-CAP	T39
10MJ-8FP90	T36	8FFOR-CAP	T39
12MJ-8FP90	T36	10FFOR-CAP	T39
12MJ-12FP90	T36	12FFOR-CAP	T39
14MJ-12FP90	T36	16FFOR-CAP	T39
16MJ-16FP90	T36	20FFOR-CAP	T39
20MJ-20FP90	T36	24FFOR-CAP	T39
24MJ-24FP90	T36	Male Flat-Face O-Ring Plug	T39
Female JIC 37° Flare Swivel to Male Pipe NPTF	T36	4MFFOR-PLUG	T39
4FJX-2MP	T36	6MFFOR-PLUG	T39
4FJX-4MP	T36	8MFFOR-PLUG	T39
6FJX-4MP	T36	10MFFOR-PLUG	T39
6FJX-6MP	T36	12MFFOR-PLUG	T39
8FJX-6MP	T36	16MFFOR-PLUG	T39
8FJX-8MP	T36	20MFFOR-PLUG	T39
10FJX-8MP	T36	24MFFOR-PLUG	T39
12FJX-8MP	T36	32MFFOR-PLUG	T39
12FJX-12MP	T36	Male Flat-Face O-Ring to Male Flat-Face O-Ring	T40
16FJX-16MP	T36	4MFFOR-4MFFOR	T40
20FJX-20MP	T36	6MFFOR-4MFFOR	T40
Female JIC 37° Flare Swivel to Male Pipe NPTF - 90°	T37	6MFFOR-6MFFOR	T40
4FJX-2MP90	T37	8MFFOR-6MFFOR	T40
4FJX-4MP90	T37	8MFFOR-8MFFOR	T40
6FJX-4MP90	T37	10MFFOR-10MFFOR	T40
6FJX-6MP90	T37	12MFFOR-12MFFOR	T40
8FJX-6MP90	T37	16MFFOR-16MFFOR	T40
8FJX-8MP90	T37	20MFFOR-20MFFOR	T40
10FJX-8MP90	T37	24MFFOR-24MFFOR	T40
12FJX-12MP90	T37	Male Flat-Face O-Ring to Male Flat-Face O-Ring - 90°	T40
16FJX-16MP90	T37	4MFFOR-4MFFOR90	T40
20FJX-20MP90	T37	8MFFOR-8MFFOR90	T40
24FJX-24MP90	T37	Male Flat-Face O-Ring to Female Flat-Face Swivel - 90°	T41
Female JIC 37° Flare Swivel to Female Pipe NPTF	T37	4MFFOR-4FFORX90	T41
4FJX-2FP	T37	6MFFOR-6FFORX90	T41
4FJX-4FP	T37	8MFFOR-8FFORX90	T41
6FJX-6FP	T37	10MFFOR-10FFORX90	T41
8FJX-6FP	T37	12MFFOR-12FFORX90	T41
8FJX-8FP	T37	16MFFOR-16FFORX90	T41
10FJX-8FP	T37	20MFFOR-20FFORX90	T41
12FJX-12FP	T37	24MFFOR-24FFORX90	T41
16FJX-16FP	T37	Male Flat-Face O-Ring Tee	T41
20FJX-20FP	T37	4MFFOR-4MFFOR-4MFFOR	T41
Male JIC 37° Flare Bulkhead to Male Pipe NPTF	T38	6MFFOR-6MFFOR-6MFFOR	T41
4MJBKHD-2MP	T38	8MFFOR-8MFFOR-8MFFOR	T41
4MJBKHD-4MP	T38	10MFFOR-10MFFOR-10MFFOR	T41
6MJBKHD-4MP	T38	12MFFOR-12MFFOR-12MFFOR	T41
8MJBKHD-6MP	T38	16MFFOR-16MFFOR-16MFFOR	T41
8MJBKHD-8MP	T38	20MFFOR-20MFFOR-20MFFOR	T41
10MJBKHD-8MP	T38		
12MJBKHD-8MP	T38		



Category	Page
<b>SAE to SAE Adapters (Continued)</b>	
Male Flat-Face O-Ring on Run to Female Flat-Face Swivel - Tee	T42
4MFFOR-4MFFOR-4FFORX	T42
6MFFOR-6MFFOR-6FFORX	T42
8MFFOR-8MFFOR-8FFORX	T42
10MFFOR-10MFFOR-10FFORX	T42
12MFFOR-12MFFOR-12FFORX	T42
16MFFOR-16MFFOR-16FFORX	T42
20MFFOR-20MFFOR-20FFORX	T42
Male Flat-Face O-Ring to Female Flat-Face O-Ring to Male Flat-Face O-Ring - Tee	T42
4MFFOR-4FFORX-4MFFOR	T42
6MFFOR-6FFORX-6MFFOR	T42
8MFFOR-8FFORX-8MFFOR	T42
10MFFOR-10FFORX-10MFFOR	T42
12MFFOR-12FFORX-12MFFOR	T42
16MFFOR-16FFORX-16MFFOR	T42
20MFFOR-20FFORX-20MFFOR	T42
Male Flat-Face O-Ring to Male Pipe NPTF	T43
4MFFOR-2MP	T43
4MFFOR-4MP	T43
4MFFOR-6MP	T43
6MFFOR-4MP	T43
6MFFOR-6MP	T43
6MFFOR-8MP	T43
8MFFOR-4MP	T43
8MFFOR-6MP	T43
8MFFOR-8MP	T43
8MFFOR-12MP	T43
10MFFOR-8MP	T43
10MFFOR-12MP	T43
12MFFOR-8MP	T43
12MFFOR-12MP	T43
12MFFOR-16MP	T43
16MFFOR-12MP	T43
16MFFOR-16MP	T43
20MFFOR-20MP	T43
24MFFOR-24MP	T43
Male Flat-Face O-Ring to Female JIC 37° Flare Swivel	T43
4MFFOR-4FJX	T43
6MFFOR-6FJX	T43
8MFFOR-8FJX	T43
10MFFOR-10FJX	T43
12MFFOR-12FJX	T43
16MFFOR-16FJX	T43
Male Flat-Face O-Ring to Male O-Ring Boss	T44
4MFFOR-4MB	T44
4MFFOR-6MB	T44
4MFFOR-8MB	T44
6MFFOR-4MB	T44
6MFFOR-6MB	T44
6MFFOR-8MB	T44
6MFFOR-10MB	T44
8MFFOR-6MB	T44
8MFFOR-8MB	T44
8MFFOR-10MB	T44
8MFFOR-12MB	T44
8MFFOR-16MB	T44
10MFFOR-8MB	T44
10MFFOR-10MB	T44
10MFFOR-12MB	T44
12MFFOR-8MB	T44
12MFFOR-10MB	T44
12MFFOR-12MB	T44
12MFFOR-16MB	T44
16MFFOR-12MB	T44
16MFFOR-16MB	T44
16MFFOR-20MB	T44
20MFFOR-16MB	T44
20MFFOR-20MB	T44
20MFFOR-24MB	T44
24MFFOR-20MB	T44
24MFFOR-24MB	T44
32MFFOR-32MB	T44
Male Flat-Face O-Ring to Male O-Ring Boss - 45°	T45
4MFFOR-4MB45	T45
4MFFOR-6MB45	T45
6MFFOR-4MB45	T45
6MFFOR-6MB45	T45
6MFFOR-8MB45	T45

Category	Page
<b>SAE to SAE Adapters (Continued)</b>	
Male Flat-Face O-Ring to Male O-Ring Boss - 45° (Continued)	T45
8MFFOR-6MB45	T45
8MFFOR-8MB45	T45
8MFFOR-10MB45	T45
8MFFOR-12MB45	T45
10MFFOR-8MB45	T45
10MFFOR-10MB45	T45
10MFFOR-12MB45	T45
12MFFOR-10MB45	T45
12MFFOR-12MB45	T45
12MFFOR-16MB45	T45
16MFFOR-12MB45	T45
16MFFOR-16MB45	T45
16MFFOR-20MB45	T45
20MFFOR-20MB45	T45
24MFFOR-24MB45	T45
Male Flat-Face O-Ring to Male O-Ring Boss - 90°	T45
4MFFOR-4MB90	T45
4MFFOR-6MB90	T45
4MFFOR-8MB90	T45
6MFFOR-4MB90	T45
6MFFOR-6MB90	T45
6MFFOR-8MB90	T46
6MFFOR-12MB90	T46
8MFFOR-6MB90	T46
8MFFOR-8MB90	T46
8MFFOR-10MB90	T46
8MFFOR-12MB90	T46
10MFFOR-8MB90	T46
10MFFOR-10MB90	T46
10MFFOR-12MB90	T46
12MFFOR-8MB90	T46
12MFFOR-10MB90	T46
12MFFOR-12MB90	T46
12MFFOR-16MB90	T46
16MFFOR-12MB90	T46
16MFFOR-16MB90	T46
16MFFOR-20MB90	T46
20MFFOR-16MB90	T46
20MFFOR-20MB90	T46
20MFFOR-24MB90	T46
24MFFOR-20MB90	T46
24MFFOR-24MB90	T46
Male Flat-Face O-Ring to Male O-Ring Boss - 90° Long Drop	T46
4MFFOR-4MB90L	T46
6MFFOR-6MB90L	T46
12MFFOR-12MB90L	T46
16MFFOR-16MB90L	T46
Male Flat-Face O-Ring on Run to Male O-Ring Boss - Tee	T47
4MFFOR-4MFFOR-4MB	T47
6MFFOR-6MFFOR-6MB	T47
8MFFOR-8MFFOR-8MB	T47
10MFFOR-10MFFOR-10MB	T47
12MFFOR-12MFFOR-12MB	T47
16MFFOR-16MFFOR-16MB	T47
20MFFOR-20MFFOR-20MB	T47
Male Flat-Face O-Ring to Male O-Ring Boss to Male Flat-Face O-Ring - Tee	T47
4MFFOR-4MB-4MFFOR	T47
6MFFOR-6MB-6MFFOR	T47
8MFFOR-8MB-8MFFOR	T47
10MFFOR-10MB-10MFFOR	T47
12MFFOR-12MB-12MFFOR	T47
16MFFOR-16MB-16MFFOR	T47
20MFFOR-20MB-20MFFOR	T47
24MFFOR-24MB-24MFFOR	T47
Female Flat-Face Swivel to Male JIC 37° Flare	T48
4FFORX-4MJ	T48
6FFORX-6MJ	T48
8FFORX-8MJ	T48
10FFORX-10MJ	T48
12FFORX-12MJ	T48
16FFORX-16MJ	T48
<b>SAE to SAE - High Pressure Adapters</b>	
Code 61 O-Ring Flange to Male JIC 37° Flare	T49
8FL-8MJ	T49
12FL-12MJ	T49



Category	Page	Category	Page
<b>SAE to SAE - High Pressure Adapters (Continued)</b>		<b>SAE to SAE - High Pressure Adapters (Continued)</b>	
Code 61 O-Ring Flange to Male JIC 37° Flare (Continued)	T49	Code 62 O-Ring Flange Heavy to Male Flat-Face O-Ring - (6,000 psi) (Continued)	T55
16FL-16MJ	T49	16FLH6K-16MFFOR	T55
20FL-20MJ	T49	20FLH6K-20MFFOR	T55
24FL-24MJ	T49		
32FL-32MJ	T49	Code 62 O-Ring Flange Heavy to Male Flat-Face O-Ring 45° - (6,000 psi)	T55
		12FLH6K-12MFFOR45	T55
Code 61 O-Ring Flange to Male JIC 37° Flare - High Pressure	T49	16FLH6K-16MFFOR45	T55
12FL5K-12MJ	T49	20FLH6K-20MFFOR45	T55
16FL5K-12MJ	T49		
16FL5K-16MJ	T49	Code 62 O-Ring Flange Heavy to Male Flat-Face O-Ring 90° - (6,000 psi)	T55
16FL5K-20MJ	T49	12FLH6K-12MFFOR90	T55
20FL4K-16MJ	T49	16FLH6K-12MFFOR90	T56
20FL4K-20MJ	T49	16FLH6K-16MFFOR90	T56
		20FLH6K-20MFFOR90	T56
Code 61 O-Ring Flange to Male JIC 37° Flare - 45°	T50	<b>British to SAE Adapters</b>	
8FL-8MJ45	T50	Male British Standard Pipe Tapered Thread to Male JIC 37° Flare	T57
12FL-12MJ45	T50	2MBSPT-4MJ	T57
16FL-16MJ45	T50	2MBSPT-5MJ	T57
20FL-20MJ45	T50	2MBSPT-6MJ	T57
24FL-24MJ45	T50	4MBSPT-4MJ	T57
32FL-32MJ45	T50	4MBSPT-5MJ	T57
		4MBSPT-6MJ	T57
Code 61 O-Ring Flange to Male JIC 37° Flare - 45° - High Pressure	T50	4MBSPT-8MJ	T57
12FL5K-12MJ45	T50	6MBSPT-4MJ	T57
16FL5K-16MJ45	T50	6MBSPT-5MJ	T57
20FL4K-16MJ45	T50	6MBSPT-6MJ	T57
20FL4K-20MJ45	T50	6MBSPT-8MJ	T57
		6MBSPT-10MJ	T57
Code 61 O-Ring Flange to Male JIC 37° Flare - 90°	T51	8MBSPT-6MJ	T57
8FL-8MJ90	T51	8MBSPT-8MJ	T57
12FL-12MJ90	T51	8MBSPT-10MJ	T57
16FL-16MJ90	T51	8MBSPT-12MJ	T57
20FL-20MJ90	T51	12MBSPT-8MJ	T57
24FL-24MJ90	T51	12MBSPT-10MJ	T57
32FL-32MJ90	T51	12MBSPT-12MJ	T57
		12MBSPT-14MJ	T57
Code 61 O-Ring Flange to Male JIC 37° Flare - 90° - High Pressure	T51	12MBSPT-16MJ	T57
12FL5K-12MJ90	T51	16MBSPT-12MJ	T57
16FL5K-12MJ90	T51	16MBSPT-16MJ	T57
16FL5K-16MJ90	T51	16MBSPT-20MJ	T57
20FL4K-16MJ90	T51	20MBSPT-16MJ	T57
20FL4K-20MJ90	T51	20MBSPT-20MJ	T57
		24MBSPT-24MJ	T57
Code 61 O-Ring Flange to Male Flat-Face O-Ring - High Pressure	T52	32MBSPT-32MJ	T57
12FL5K-12MFFOR	T52	Male British Standard Pipe Tapered Thread to Male JIC 37° Flare - 45°	T57
16FL5K-12MFFOR	T52	2MBSPT-4MJ45	T57
16FL5K-16MFFOR	T52	4MBSPT-4MJ45	T58
20FL4K-20MFFOR	T52	4MBSPT-6MJ45	T58
		6MBSPT-6MJ45	T58
Code 61 O-Ring Flange to Male Flat-Face O-Ring 45° - High Pressure	T52	6MBSPT-8MJ45	T58
12FL5K-12MFFOR45	T52	8MBSPT-8MJ45	T58
16FL5K-16MFFOR45	T52	8MBSPT-10MJ45	T58
20FL4K-20MFFOR45	T52	12MBSPT-12MJ45	T58
		12MBSPT-16MJ45	T58
Code 61 O-Ring Flange to Male Flat-Face O-Ring 90° - High Pressure	T53	16MBSPT-16MJ45	T58
12FL5K-12MFFOR90	T53	Male British Standard Pipe Tapered Thread to Male JIC 37° Flare - 90°	T58
16FL5K-16MFFOR90	T53	2MBSPT-4MJ90	T58
20FL4K-20MFFOR90	T53	4MBSPT-4MJ90	T58
		4MBSPT-5MJ90	T58
Code 62 O-Ring Flange Heavy to Male JIC 37° Flare - (6,000 psi)	T53	4MBSPT-6MJ90	T58
12FLH6K-12MJ	T53	6MBSPT-6MJ90	T58
16FLH6K-12MJ	T53	6MBSPT-8MJ90	T58
16FLH6K-16MJ	T53	8MBSPT-6MJ90	T58
16FLH6K-20MJ	T53	8MBSPT-8MJ90	T58
20FLH6K-16MJ	T53	8MBSPT-10MJ90	T58
20FLH6K-20MJ	T53	8MBSPT-12MJ90	T58
24FLH6K-20MJ	T53	12MBSPT-12MJ90	T58
24FLH6K-24MJ	T53	12MBSPT-16MJ90	T58
		16MBSPT-16MJ90	T58
Code 62 O-Ring Flange Heavy to Male JIC 37° Flare 45° - (6,000 psi)	T54	20MBSPT-20MJ90	T58
12FLH6K-12MJ45	T54	24MBSPT-24MJ90	T58
16FLH6K-16MJ45	T54	Male British Standard Pipe Parallel to Male Pipe NPTF	T59
20FLH6K-20MJ45	T54	2MBSPP-2MP	T59
		2MBSPP-4MP	T59
Code 62 O-Ring Flange Heavy to Male JIC 37° Flare 90° - (6,000 psi)	T54	4MBSPP-2MP	T59
12FLH6K-12MJ90	T54	4MBSPP-4MP	T59
12FLH6K-16MJ90	T54	4MBSPP-6MP	T59
16FLH6K-12MJ90	T54	4MBSPP-8MP	T59
16FLH6K-16MJ90	T54		
16FLH6K-20MJ90	T54		
20FLH6K-16MJ90	T54		
20FLH6K-20MJ90	T54		
24FLH6K-20MJ90	T54		
Code 62 O-Ring Flange Heavy to Male Flat-Face O-Ring - (6,000 psi)	T55		
12FLH6K-12MFFOR	T55		



Category	Page	Category	Page
<b>British to SAE Adapters (Continued)</b>		<b>British to SAE Adapters (Continued)</b>	
Male British Standard Pipe Parallel to Male Pipe NPTF (Continued)	T59	Male British Standard Pipe Parallel to Male JIC 37° Flare (Continued)	T61
6MBSPP-2MP	T59	24MBSPP-24MJ	T61
6MBSPP-4MP	T59	32MBSPP-32MJ	T61
6MBSPP-6MP	T59	Male British Standard Pipe Parallel to Male JIC 37° Flare - 45°	T61
6MBSPP-8MP	T59	2MBSPP-4MJ45	T61
6MBSPP-12MP	T59	4MBSPP-4MJ45	T61
6MBSPP-16MP	T59	4MBSPP-6MJ45	T61
8MBSPP-4MP	T59	6MBSPP-6MJ45	T61
8MBSPP-6MP	T59	6MBSPP-8MJ45	T61
8MBSPP-8MP	T59	8MBSPP-8MJ45	T61
8MBSPP-12MP	T59	8MBSPP-10MJ45	T61
8MBSPP-16MP	T59	8MBSPP-12MJ45	T61
10MBSPP-8MP	T59	12MBSPP-12MJ45	T61
10MBSPP-12MP	T59	16MBSPP-16MJ45	T61
12MBSPP-8MP	T59	Male British Standard Pipe Parallel to Male JIC 37° Flare - 90°	T62
12MBSPP-12MP	T59	2MBSPP-4MJ90	T62
12MBSPP-16MP	T59	4MBSPP-4MJ90	T62
12MBSPP-20MP	T59	4MBSPP-5MJ90	T62
16MBSPP-12MP	T59	4MBSPP-6MJ90	T62
16MBSPP-16MP	T59	4MBSPP-8MJ90	T62
16MBSPP-20MP	T59	6MBSPP-4MJ90	T62
20MBSPP-16MP	T59	6MBSPP-5MJ90	T62
20MBSPP-20MP	T59	6MBSPP-8MJ90	T62
20MBSPP-24MP	T59	8MBSPP-6MJ90	T62
24MBSPP-20MP	T59	8MBSPP-10MJ90	T62
24MBSPP-24MP	T59	8MBSPP-12MJ90	T62
32MBSPP-32MP	T59	12MBSPP-8MJ90	T62
Male British Standard Pipe Parallel to Female Pipe NPTF	T59	12MBSPP-10MJ90	T62
2MBSPP-2FP	T59	12MBSPP-16MJ90	T62
2MBSPP-4FP	T60	16MBSPP-12MJ90	T62
4MBSPP-2FP	T60	16MBSPP-16MJ90	T62
4MBSPP-4FP	T60	16MBSPP-20MJ90	T62
4MBSPP-6FP	T60	20MBSPP-16MJ90	T62
6MBSPP-2FP	T60	20MBSPP-20MJ90	T62
6MBSPP-4FP	T60	24MBSPP-24MJ90	T62
6MBSPP-6FP	T60	Male British Standard Pipe Parallel to Female JIC 37° Flare Swivel	T62
8MBSPP-4FP	T60	2MBSPP-4FJX	T62
8MBSPP-6FP	T60	4MBSPP-4FJX	T62
8MBSPP-8FP	T60	4MBSPP-5FJX	T62
12MBSPP-8FP	T60	4MBSPP-6FJX	T62
12MBSPP-12FP	T60	6MBSPP-4FJX	T62
16MBSPP-16FP	T60	6MBSPP-6FJX	T62
20MBSPP-16FP	T60	6MBSPP-8FJX	T63
20MBSPP-20FP	T60	8MBSPP-4FJX	T63
24MBSPP-20FP	T60	8MBSPP-6FJX	T63
24MBSPP-24FP	T60	8MBSPP-8FJX	T63
32MBSPP-32FP	T60	8MBSPP-10FJX	T63
Male British Standard Pipe Parallel to Male JIC 37° Flare	T60	8MBSPP-12FJX	T63
2MBSPP-4MJ	T60	10MBSPP-8FJX	T63
2MBSPP-5MJ	T60	10MBSPP-10FJX	T63
2MBSPP-6MJ	T60	12MBSPP-8FJX	T63
4MBSPP-4MJ	T60	12MBSPP-12FJX	T63
4MBSPP-5MJ	T60	12MBSPP-16FJX	T63
4MBSPP-6MJ	T60	16MBSPP-16FJX	T63
4MBSPP-8MJ	T60	16MBSPP-20FJX	T63
6MBSPP-4MJ	T60	20MBSPP-16FJX	T63
6MBSPP-5MJ	T60	20MBSPP-20FJX	T63
6MBSPP-6MJ	T60	24MBSPP-24FJX	T63
6MBSPP-8MJ	T60	32MBSPP-32FJX	T63
8MBSPP-6MJ	T60	Male British Standard Pipe Parallel with O-Ring to Male JIC 37° Flare	T63
8MBSPP-8MJ	T60	2MBSPPOR-4MJ	T63
8MBSPP-10MJ	T60	4MBSPPOR-4MJ	T63
8MBSPP-12MJ	T60	4MBSPPOR-5MJ	T63
10MBSPP-8MJ	T60	4MBSPPOR-6MJ	T63
10MBSPP-10MJ	T60	6MBSPPOR-4MJ	T63
10MBSPP-12MJ	T60	6MBSPPOR-5MJ	T63
12MBSPP-8MJ	T60	6MBSPPOR-6MJ	T63
12MBSPP-10MJ	T60	6MBSPPOR-8MJ	T63
12MBSPP-12MJ	T60	8MBSPPOR-6MJ	T63
12MBSPP-14MJ	T60	8MBSPPOR-8MJ	T63
12MBSPP-16MJ	T61	8MBSPPOR-10MJ	T63
16MBSPP-12MJ	T61	8MBSPPOR-12MJ	T63
16MBSPP-14MJ	T61	12MBSPPOR-8MJ	T63
16MBSPP-16MJ	T61	12MBSPPOR-10MJ	T63
16MBSPP-20MJ	T61	12MBSPPOR-12MJ	T63
20MBSPP-16MJ	T61	12MBSPPOR-16MJ	T63
20MBSPP-20MJ	T61	16MBSPPOR-12MJ	T63
20MBSPP-24MJ	T61	16MBSPPOR-16MJ	T63
24MBSPP-20MJ	T61		



Category	Page	Category	Page
<b>British to SAE Adapters (Continued)</b>		<b>British to SAE Adapters (Continued)</b>	
Male British Standard Pipe Parallel with O-Ring to Male JIC 37° Flare (Continued)	T63	Female British Standard Pipe Parallel to Female Pipe NPTF (Continued)	T67
20MBSPPOR-20MJ	T63	6FBSPP-6FP	T67
20MBSPPOR-24MJ	T63	8FBSPP-8FP	T67
24MBSPPOR-24MJ	T63	12FBSPP-12FP	T67
		16FBSPP-16FP	T67
		20FBSPP-20FP	T67
Male British Standard Pipe Parallel with O-Ring to Male JIC 37° Flare - 90°	T64	Female British Standard Pipe Parallel to Male JIC 37° Flare	T67
6MBSPPOR-6MJ90	T64	2FBSPP-4MJ	T67
8MBSPPOR-8MJ90	T64	4FBSPP-4MJ	T67
12MBSPPOR-12MJ90	T64	4FBSPP-6MJ	T67
		6FBSPP-6MJ	T67
Male British Standard Pipe Parallel with O-Ring to Male Flat-Face O-Ring	T64	8FBSPP-8MJ	T67
2MBSPPOR-4MFFOR	T64	12FBSPP-12MJ	T67
4MBSPPOR-4MFFOR	T64	16FBSPP-16MJ	T67
4MBSPPOR-6MFFOR	T64	20FBSPP-20MJ	T67
6MBSPPOR-6MFFOR	T64	24FBSPP-24MJ	T67
6MBSPPOR-8MFFOR	T64		
8MBSPPOR-6MFFOR	T64	Female British Standard Pipe Parallel Swivel to Male Pipe NPTF - 90°	T68
8MBSPPOR-8MFFOR	T64	2FBSPPX-2MP90	T68
8MBSPPOR-10MFFOR	T64	4FBSPPX-4MP90	T68
12MBSPPOR-12MFFOR	T64	6FBSPPX-6MP90	T68
12MBSPPOR-16MFFOR	T64	8FBSPPX-8MP90	T68
16MBSPPOR-12MFFOR	T64	12FBSPPX-12MP90	T68
16MBSPPOR-16MFFOR	T64	16FBSPPX-16MP90	T68
20MBSPPOR-20MFFOR	T64	20FBSPPX-20MP90	T68
24MBSPPOR-24MFFOR	T64	24FBSPPX-24MP90	T68
Male British Standard Pipe Parallel with O-Ring to Male Flat-Face O-Ring - Long	T65	Female British Standard Pipe Parallel Swivel to Male JIC 37° Flare	T68
6MBSPPOR-8MFFORL	T65	2FBSPPX-4MJ	T68
8MBSPPOR-8MFFORL	T65	4FBSPPX-4MJ	T68
8MBSPPOR-10MFFORL	T65	4FBSPPX-5MJ	T68
12MBSPPOR-10MFFORL	T65	4FBSPPX-6MJ	T68
12MBSPPOR-12MFFORL	T65	6FBSPPX-4MJ	T68
16MBSPPOR-16MFFORL	T65	6FBSPPX-5MJ	T68
20MBSPPOR-20MFFORL	T65	6FBSPPX-6MJ	T68
		6FBSPPX-8MJ	T68
Male British Standard Pipe Parallel with O-Ring to Male Flat-Face O-Ring - 45°	T65	6FBSPPX-10MJ	T68
2MBSPPOR-4MFFOR45	T65	8FBSPPX-6MJ	T68
4MBSPPOR-4MFFOR45	T65	8FBSPPX-8MJ	T68
4MBSPPOR-6MFFOR45	T65	8FBSPPX-10MJ	T68
6MBSPPOR-6MFFOR45	T65	10FBSPPX-8MJ	T68
6MBSPPOR-8MFFOR45	T65	10FBSPPX-10MJ	T68
8MBSPPOR-8MFFOR45	T65	12FBSPPX-8MJ	T68
8MBSPPOR-10MFFOR45	T65	12FBSPPX-10MJ	T68
		12FBSPPX-12MJ	T68
Male British Standard Pipe Parallel with O-Ring to Male Flat-Face O-Ring - 90°	T66	12FBSPPX-16MJ	T68
2MBSPPOR-4MFFOR90	T66	16FBSPPX-12MJ	T68
4MBSPPOR-4MFFOR90	T66	16FBSPPX-16MJ	T68
4MBSPPOR-6MFFOR90	T66	20FBSPPX-20MJ	T68
4MBSPPOR-8MFFOR90	T66	24FBSPPX-24MJ	T68
6MBSPPOR-6MFFOR90	T66		
6MBSPPOR-8MFFOR90	T66	Female British Standard Pipe Parallel Swivel to Female JIC 37° Flare Swivel	T69
8MBSPPOR-6MFFOR90	T66	4FBSPPX-4FJX	T69
8MBSPPOR-8MFFOR90	T66	4FBSPPX-6FJX	T69
8MBSPPOR-10MFFOR90	T66	6FBSPPX-6FJX	T69
8MBSPPOR-12MFFOR90	T66	6FBSPPX-8FJX	T69
12MBSPPOR-12MFFOR90	T66	8FBSPPX-6FJX	T69
12MBSPPOR-16MFFOR90	T66	8FBSPPX-8FJX	T69
16MBSPPOR-12MFFOR90	T66	10FBSPPX-10FJX	T69
16MBSPPOR-16MFFOR90	T66	12FBSPPX-12FJX	T69
20MBSPPOR-16MFFOR90	T66	16FBSPPX-16FJX	T69
20MBSPPOR-20MFFOR90	T66	20FBSPPX-20FJX	T69
24MBSPPOR-24MFFOR90	T66		
		Female British Flat-Face O-Ring to Male JIC 37° Flare	T69
Female British Standard Pipe Parallel to Male Pipe NPTF	T66	6FBFFOR-6MJ	T69
2FBSPP-2MP	T66	8FBFFOR-6MJ	T69
2FBSPP-4MP	T66	8FBFFOR-8MJ	T69
4FBSPP-4MP	T66	8FBFFOR-10MJ	T69
4FBSPP-6MP	T66	10FBFFOR-8MJ	T69
4FBSPP-8MP	T66	12FBFFOR-8MJ	T69
6FBSPP-6MP	T66	12FBFFOR-10MJ	T69
6FBSPP-8MP	T66	12FBFFOR-12MJ	T69
8FBSPP-8MP	T66		
8FBSPP-12MP	T66	<b>Metric Conversion Adapters</b>	
12FBSPP-12MP	T66	Male Metric O-Ring Plug	T70
12FBSPP-16MP	T66	12MMOR-PLUG	T70
16FBSPP-16MP	T66	14MMOR-PLUG	T70
20FBSPP-20MP	T67	16MMOR-PLUG	T70
20FBSPP-24MP	T67	18MMOR-PLUG	T70
24FBSPP-24MP	T67	20MMOR-PLUG	T70
32FBSPP-32MP	T67	22MMOR-PLUG	T70
Female British Standard Pipe Parallel to Female Pipe NPTF	T67		
4FBSPP-4FP	T67		



Category	Page	Category	Page
<b>Metric Conversion Adapters (Continued)</b>		<b>Metric Conversion Adapters (Continued)</b>	
Male Metric O-Ring Plug (Continued)	T70	Male DIN 24° Cone - Light Series to Male JIC 37° Flare (Continued)	T72
24MMOR-PLUG	T70	15MDL-8MJ	T72
26MMOR-PLUG	T70	15MDL-10MJ	T72
30MMOR-PLUG	T70	15MDL-12MJ	T72
36MMOR-PLUG	T70	18MDL-10MJ	T72
42MMOR-PLUG	T70	18MDL-12MJ	T72
		22MDL-12MJ	T72
Male Metric with O-Ring to Female Pipe NPTF	T70	28MDL-16MJ	T72
10MM-2FP	T70	35MDL-20MJ	T72
12MM-2FP	T70	42MDL-24MJ	T72
12MM-4FP	T70		
12MM-6FP	T70	Female DIN 24° Cone Swivel - Light Series to Male JIC 37° Flare	T73
14MM-4FP	T70	6FDLX-4MJ	T73
16MM-6FP	T70	6FDLX-5MJ	T73
16MM-8FP	T70	8FDLX-4MJ	T73
18MM-6FP	T70	8FDLX-6MJ	T73
18MM-8FP	T70	10FDLX-6MJ	T73
20MM-4FP	T70	10FDLX-8MJ	T73
20MM-6FP	T70	12FDLX-6MJ	T73
20MM-8FP	T70	12FDLX-8MJ	T73
22MM-6FP	T70	12FDLX-10MJ	T73
22MM-8FP	T70	15FDLX-6MJ	T73
22MM-12FP	T70	15FDLX-8MJ	T73
24MM-12FP	T70	15FDLX-10MJ	T73
26MM-12FP	T70	22FDLX-12MJ	T73
27MM-12FP	T70	28FDLX-16MJ	T73
33MM-16FP	T70		
Male Metric with O-Ring to Male JIC 37° Flare	T71	Male DIN 24° Cone - Heavy Series to Male JIC 37° Flare	T73
10MM-4MJ	T71	6MDH-4MJ	T73
12MM-4MJ	T71	8MDH-4MJ	T73
12MM-5MJ	T71	8MDH-6MJ	T73
12MM-6MJ	T71	10MDH-4MJ	T73
14MM-4MJ	T71	10MDH-8MJ	T73
14MM-6MJ	T71	12MDH-6MJ	T73
14MM-8MJ	T71	12MDH-8MJ	T73
16MM-5MJ	T71	12MDH-10MJ	T73
16MM-6MJ	T71	14MDH-6MJ	T73
16MM-8MJ	T71	14MDH-8MJ	T73
18MM-8MJ	T71	16MDH-8MJ	T73
18MM-10MJ	T71	16MDH-10MJ	T73
20MM-10MJ	T71	16MDH-12MJ	T73
22MM-8MJ	T71	20MDH-10MJ	T73
22MM-10MJ	T71	20MDH-12MJ	T73
22MM-12MJ	T71	25MDH-12MJ	T73
26MM-12MJ	T71	25MDH-16MJ	T73
27MM-12MJ	T71	30MDH-16MJ	T73
27MM-16MJ	T71	38MDH-20MJ	T73
33MM-16MJ	T71	38MDH-24MJ	T74
33MM-20MJ	T71		
42MM-20MJ	T71	Female DIN 24° Cone Swivel - Heavy Series to Male JIC 37° Flare	T74
48MM-24MJ	T71	10FDHX-4MJ	T74
		12FDHX-5MJ	T74
		12FDHX-6MJ	T74
		12FDHX-8MJ	T74
		12FDHX-10MJ	T74
		14FDHX-6MJ	T74
		16FDHX-8MJ	T74
		20FDHX-10MJ	T74
		25FDHX-12MJ	T74
		30FDHX-16MJ	T74
		38FDHX-20MJ	T74
		Male Kobelco Plug	T74
		22MKB-PLUG	T74
		Male Kobelco to Male JIC 37° Flare	T75
		22MKB-12MJ	T75
		28MKB-12MJ	T75
		28MKB-16MJ	T75
		35MKB-16MJ	T75
		35MKB-20MJ	T75
		<b>International to International Adapters</b>	
		British Bonded Seal	T76
		2BBDS	T76
		4BBDS	T76
		6BBDS	T76
		8BBDS	T76
		10BBDS	T76
		12BBDS	T76
		16BBDS	T76
		20BBDS	T76
Male DIN 24° Cone - Light Series to Male JIC 37° Flare	T72		
6MDL-4MJ	T72		
8MDL-4MJ	T72		
8MDL-6MJ	T72		
10MDL-4MJ	T72		
10MDL-6MJ	T72		
10MDL-8MJ	T72		
12MDL-6MJ	T72		
12MDL-8MJ	T72		





Category	Page	Category	Page
<b>International to International Adapters (Continued)</b>		<b>International to International Adapters (Continued)</b>	
British Bonded Seal (Continued)	T76	Metric Bonded Seal	T79
24BBDS	T76	6MBDS	T79
32BBDS	T76	8MBDS	T79
40BBDS	T76	10MBDS	T79
48BBDS	T76	12MBDS	T79
Male British Standard Pipe Parallel with O-Ring Plug	T76	14MBDS	T79
2MBSPOR-PLUG	T76	16MBDS	T79
4MBSPOR-PLUG	T76	18MBDS	T79
6MBSPOR-PLUG	T76	20MBDS	T79
8MBSPOR-PLUG	T76	22MBDS	T79
12MBSPOR-PLUG	T76	24MBDS	T79
16MBSPOR-PLUG	T76	26MBDS	T79
20MBSPOR-PLUG	T76	27MBDS	T79
Female British Standard Pipe Parallel Cap	T77	30MBDS	T79
2FBSPP-CAP	T77	33MBDS	T79
4FBSPP-CAP	T77	36MBDS	T79
6FBSPP-CAP	T77	42MBDS	T79
8FBSPP-CAP	T77	45MBDS	T79
10FBSPP-CAP	T77	50MBDS	T79
12FBSPP-CAP	T77	52MBDS	T79
16FBSPP-CAP	T77	Male Metric Plug	T80
20FBSPP-CAP	T77	8MM-PLUG	T80
24FBSPP-CAP	T77	10MM-PLUG	T80
32FBSPP-CAP	T77	12MM-PLUG	T80
Male British Standard Pipe Tapered Thread Plug	T77	14MM-PLUG	T80
2MBSPT-PLUG	T77	16MM-PLUG	T80
4MBSPT-PLUG	T77	18MM-PLUG	T80
6MBSPT-PLUG	T77	20MM-PLUG	T80
8MBSPT-PLUG	T77	22MM-PLUG	T80
10MBSPT-PLUG	T77	24MM-PLUG	T80
12MBSPT-PLUG	T77	26MM-PLUG	T80
16MBSPT-PLUG	T77	30MM-PLUG	T80
20MBSPT-PLUG	T77	Male DIN 24° Cone - Light Series Plug	T80
24MBSPT-PLUG	T77	6MDL-PLUG	T80
Male British Standard Pipe Parallel Plug	T78	8MDL-PLUG	T80
2MBSPP-PLUG	T78	10MDL-PLUG	T80
4MBSPP-PLUG	T78	12MDL-PLUG	T80
6MBSPP-PLUG	T78	15MDL-PLUG	T80
8MBSPP-PLUG	T78	18MDL-PLUG	T80
10MBSPP-PLUG	T78	22MDL-PLUG	T80
12MBSPP-PLUG	T78	28MDL-PLUG	T80
16MBSPP-PLUG	T78	35MDL-PLUG	T80
20MBSPP-PLUG	T78	42MDL-PLUG	T80
24MBSPP-PLUG	T78	Female DIN 24° Cone - Light Series Cap	T81
32MBSPP-PLUG	T78	6FDL-CAP	T81
Male British Standard Pipe Parallel to Female British Standard Pipe Parallel Swivel	T78	8FDL-CAP	T81
2MBSPP-2FBSPPX	T78	10FDL-CAP	T81
2MBSPP-4FBSPPX	T78	12FDL-CAP	T81
4MBSPP-2FBSPPX	T78	15FDL-CAP	T81
4MBSPP-4FBSPPX	T78	18FDL-CAP	T81
4MBSPP-6FBSPPX	T78	22FDL-CAP	T81
4MBSPP-8FBSPPX	T78	28FDL-CAP	T81
6MBSPP-4FBSPPX	T78	35FDL-CAP	T81
6MBSPP-6FBSPPX	T78	42FDL-CAP	T81
6MBSPP-8FBSPPX	T78	Male DIN 24° Cone - Heavy Series Plug	T81
8MBSPP-6FBSPPX	T78	8MDH-PLUG	T81
8MBSPP-8FBSPPX	T78	10MDH-PLUG	T81
8MBSPP-10FBSPPX	T78	12MDH-PLUG	T81
8MBSPP-12FBSPPX	T78	14MDH-PLUG	T81
10MBSPP-8FBSPPX	T78	16MDH-PLUG	T81
10MBSPP-10FBSPPX	T78	20MDH-PLUG	T81
10MBSPP-12FBSPPX	T78	25MDH-PLUG	T81
12MBSPP-6FBSPPX	T78	30MDH-PLUG	T81
12MBSPP-8FBSPPX	T78	38MDH-PLUG	T81
12MBSPP-10FBSPPX	T78	Female DIN 24° Cone - Heavy Series Cap	T82
12MBSPP-12FBSPPX	T78	8FDH-CAP	T82
12MBSPP-16FBSPPX	T78	10FDH-CAP	T82
12MBSPP-20FBSPPX	T78	12FDH-CAP	T82
16MBSPP-12FBSPPX	T79	14FDH-CAP	T82
16MBSPP-16FBSPPX	T79	16FDH-CAP	T82
16MBSPP-20FBSPPX	T79	20FDH-CAP	T82
20MBSPP-16FBSPPX	T79	25FDH-CAP	T82
20MBSPP-20FBSPPX	T79	30FDH-CAP	T82
20MBSPP-24FBSPPX	T79	38FDH-CAP	T82
24MBSPP-20FBSPPX	T79		
24MBSPP-24FBSPPX	T79		
32MBSPP-32FBSPPX	T79		



Category	Page	Category	Page
<b>Japanese Conversion Adapters</b>		<b>Ermeto Adapters</b>	
Female Japanese Industrial Standard Cap	T83	Bite Sleeve	T87
4FJIS-CAP	T83	3ERBS	T87
6FJIS-CAP	T83	4ERBS	T87
8FJIS-CAP	T83	6ERBS	T87
12FJIS-CAP	T83	8ERBS	T87
16FJIS-CAP	T83		
20FJIS-CAP	T83	Tube Sleeve Nut	T87
32FJIS-CAP	T83	6ERTSN	T87
Male Japanese Industrial Standard Plug	T83	Ermeto to Male Pipe	T87
4MJIS-PLUG	T83	4ERT-2MP	T87
6MJIS-PLUG	T83	4ERT-4MP	T87
8MJIS-PLUG	T83		
12MJIS-PLUG	T83	Ermeto to Male Pipe - 90°	T88
16MJIS-PLUG	T83	4ERT-2MP90	T88
20MJIS-PLUG	T83		
24MJIS-PLUG	T83	Ermeto to Ermeto	T88
32MJIS-PLUG	T83	3ERT-3ERT	T88
		4ERT-4ERT	T88
Female Japanese Industrial Standard to Male JIC 37° Flare	T83	5ERT-5ERT	T88
4FJIS-4MJ	T83	6ERT-6ERT	T88
6FJIS-4MJ	T83	8ERT-8ERT	T88
6FJIS-6MJ	T83	10ERT-10ERT	T88
8FJIS-8MJ	T84		
12FJIS-12MJ	T84	<b>G940 Series (Agriculture Standard-Ball Valve)</b>	
16FJIS-16MJ	T84	Male Ball Valve to Female Pipe	U1
20FJIS-20MJ	T84	4MQBA-4FP	U1
		6MQBA-6FP	U1
Female Komatsu Cap	T84	8MQBA-8FP	U1
4FK-CAP	T84	8MQBA-12FP	U1
6FK-CAP	T84	12MQBA-12FP	U1
8FK-CAP	T84		
10FK-CAP	T84	Male Ball Valve to Female O-Ring Boss	U1
12FK-CAP	T84	8MQBA-8FB	U1
16FK-CAP	T84		
		Female Ball Valve To Female Pipe	U1
Male Komatsu Plug	T84	4FQBA-4FP	U1
4MK-PLUG	T84	6FQBADA-6FP	U1
6MK-PLUG	T84	8FQBADA-8FP	U1
8MK-PLUG	T84	8FQBA-8FP	U1
10MK-PLUG	T84	8FQBADA-12FP	U1
12MK-PLUG	T84	12FQBA-12FP	U1
16MK-PLUG	T84		
		Female Ball Valve To Female O-Ring Boss	U2
Female Komatsu to Male JIC 37° Flare	T85	8FQBA-8FB	U2
4FK-4MJ	T85		
6FK-6MJ	T85	O-Ring	U2
8FK-8MJ	T85	4QDAOR	U2
10FK-10MJ	T85	6QDAOR	U2
12FK-12MJ	T85	8QDAOR	U2
16FK-16MJ	T85	12QDAOR	U2
Male Komatsu to Male Komatsu	T85	<b>G940 and G941 Series (Agricultural)</b>	
4MK-4MK	T85	QD Dust Plug	U3
6MK-6MK	T85	4QDADP	U3
8MK-8MK	T85	6QDADP	U3
10MK-10MK	T85	8QDADP	U3
12MK-12MK	T85		
16MK-16MK	T85	QD Dust Cap	U3
		4QDADC	U3
Male Komatsu to Male JIC 37° Flare	T85	6QDADC	U3
4MK-4MJ	T85	8QDADC	U3
6MK-6MJ	T85		
8MK-8MJ	T85	<b>G941 Series (Agriculture Standard-Poppet Valve)</b>	
10MK-10MJ	T85	Male Poppet Valve to Female Pipe	U4
12MK-12MJ	T85	4MQPA-4FP	U4
16MK-16MJ	T85	6MQPA-6FP	U4
		8MQPA-8FP	U4
Male Komatsu to Female Komatsu - 90°	T86	16MQPA-16FP	U4
4MK-4FK90	T86		
6MK-6FK90	T86	Female Poppet Valve to Female Pipe	U4
8MK-8FK90	T86	4FQPA-4FP	U4
10MK-10FK90	T86	6FQPA-6FP	U4
12MK-12FK90	T86	8FQPA-8FP	U4
16MK-16FK90	T86	16FQPA-16FP	U4
Male Komatsu to Female Komatsu to Male Komatsu - Tee	T86	<b>G942 Series (John Deere Old Style)</b>	
4MK-4FK-4MK	T86	Male Ball Valve to Female Pipe	U5
6MK-6FK-6MK	T86	8MQBAJD-8FP	U5
8MK-8FK-8MK	T86		
10MK-10FK-10MK	T86	Male Ball Valve to Female O-Ring Boss	U5
12MK-12FK-12MK	T86	8MQBAJD-8FB	U5





Category	Page	Category	Page
<u>G942 Series (John Deere Old Style) (Continued)</u>		<u>G949 Series (Flush Face - HTMA) (Continued)</u>	
Female Ball Valve to Female Pipe 8FQBAJD-8FP	U5 U5	Female Flush Face Valve to Female Pipe (Continued) 6FQFF-8FP 8FQFF-8FP 8CPFOFF-8FP 12FQFF-12FP 16FQFF-16FP	U11 U11 U11 U11 U11
<u>G943 Series (International Harvester Old Style)</u>		Female Flush Face Valve to Female O-Ring Boss 4FOFF-4FB 6FOFF-8FB 8FOFF-8FB 8CPFOFF-8FB 8CPFOFF-10FB 8FOFF-12FB 8CPFOFF-12FB 10FOFF-12FB 12FQFF-12FB 16FQFF-16FB	U12 U12 U12 U12 U12 U12 U12 U12 U12 U12 U12
Male Tip - Ball Valve to Female Pipe 8MQBAIHC-8FP	U6 U6	Female Flush Face to JIC 37° Flare Bulkhead 8FOFF-10BKHD 10FOFF-12BKHD	U12 U12 U12
<u>G944 Series (J.I. Case Old Style)</u>		Female Flush Face Valve to Female British Pipe Parallel 8FOFF-8FBPP 12FOFF-12FBPP 16FOFF-16FBPP	U12 U12 U12 U12
<u>G945 Series (Industrial ISO 7241-1 - Series B)</u>		Dust Plug 4QDFFDP 6QDFFDP 8QDFFDP 10QDFFDP 12QDFFDP 16QDFFDP	U13 U13 U13 U13 U13 U13 U13
Male Poppet Valve to Female Pipe 4MQPI-4FP 6MQPI-6FP 8MQPI-8FP 12MQPI-12FP 16MQPI-16FP	U8 U8 U8 U8 U8	Dust Cap 4QDFFDC 6QDFFDC 8QDFFDC 10QDFFDC 12QDFFDC 16QDFFDC	U13 U13 U13 U13 U13 U13
Female Poppet Valve to Female Pipe 4FQPI-4FP 6FQPI-6FP 8FQPI-8FP 12FQPI-12FP 16FQPI-16FP	U8 U8 U8 U8 U8	<u>G950 Series (Flush Face - High Pressure)</u>	
O-Ring 4QDIOR 6QDIOR 8QDIOR 12QDIOR 16QDIOR	U8 U8 U8 U9 U9	Male Flush Face Valve 6MQFFH-4FP 6MQFFH-6FP 8MQFFH-8FP 12MQFFH-12FP 16MQFFH-16FPA 16MQFFH-16FP	U14 U14 U14 U14 U14 U14
Backup Ring 4QDIBR 6QDIBR 8QDIBR 12QDIBR 16QDIBR	U9 U9 U9 U9 U9	Female Flush Face Valve 6FOFFH-4FP 6FOFFH-6FP 8FOFFH-8FP 12FOFFH-12FP 16FOFFH-16FPA 16FOFFH-16FP	U14 U14 U14 U14 U14 U14
QD Plug - Cap Combination 4QDIDP/C 6QDIDP/C 8QDIDP/C 12QDIDP/C 16QDIDP/C	U9 U9 U9 U9 U9	QD Dust Plug 6QDFFHDP 8QDFFHDP 12QDFFHDP 16QDFFHDP	U14 U14 U14 U14 U14
<u>G949 Series (Flush Face - HTMA)</u>		QD Dust Cap 6QDFFHDC 8QDFFHDC 12QDFFHDC 16QDFFHDC	U15 U15 U15 U15
Male Flush Face Valve to Female Pipe 4MQFF-4FP 6MQFF-6FP 6MQFF-8FP 8MQFF-8FP 8CPMQFF-8FP 12MQFF-12FP 16MQFF-16FP	U10 U10 U10 U10 U10 U10 U10	<u>G951 Series (Wing Nut)</u>	
Male Flush Face Valve to Female O-Ring Boss 4MQFF-4FB 6MQFF-8FB 8MQFF-8FB 8CPMQFF-8FB 8CPMQFF-10FB 8MQFF-12FB 8CPMQFF-12FB 10MQFF-12FB 12MQFF-12FB 16MQFF-16FB	U10 U10 U10 U10 U10 U10 U10 U10 U10 U10	Male (Brass) - Less Flange 12MQW-12FP 16MQW-16FP 20MQW-20FP 24MQW-24FP	U16 U16 U16 U16
Male Flush Face Valve to JIC 37° Flare Bulkhead 8MQFF-10BKHD 10MQFF-12BKHD	U11 U11 U11	Female (Brass) - Wing Nut (Cast Iron) 12FQW-12FP 16FQW-16FP	U16 U16 U16
Male Flush Face Valve to Female British Pipe Parallel 4MQFF-4FBPP 8MQFF-8FBPP 12MQFF-12FBPP 16MQFF-16FBPP	U11 U11 U11 U11		
Female Flush Face Valve to Female Pipe 4FOFF-4FP 6FOFF-6FP	U11 U11 U11		



Category	Page	Category	Page
<u>G951 Series (Wing Nut) (Continued)</u>		<u>G956 Series (Industrial ISO 7241 - Series A) (Continued)</u>	
Female (Brass) - Wing Nut (Cast Iron) (Continued)	U16	QD Dust Plug (Continued)	U22
20FQW-20FP	U16	6QDDP	U22
24FQW-24FP	U16	8QDDP	U22
Dust Plug	U16	12QDDP	U22
12QWDP	U16	16QDDP	U22
16QWDP	U16	QD Dust Cap	U22
20QWDP	U17	4QDDC	U22
24QWDP	U17	6QDDC	U22
Dust Cap	U17	8QDDC	U22
12QWDC	U17	12QDDC	U22
16QWDC	U17	16QDDC	U22
20QWDC	U17	<u>G959 Series (Agriculture QD Adapters)</u>	
24QWDC	U17	John Deere Old Style to ISO Style	U23
<u>G952 Series (High Pressure Wing Nut)</u>		8MJUD-8FISO	U23
Male Acme Flat Threads to Female Pipe	U18	ISO Style to John Deere Old Style	U23
12MQWH-12FP	U18	8MISO-8FJD	U23
16MQWH-16FP	U18	Int'l Harvester to John Deere Old Style	U23
20MQWH-20FP	U18	8MIHC-8FJD	U23
24MQWH-24FP	U18	Int'l Harvester Old Style to ISO Style	U23
32MQWH-32FP	U18	8MIHC-8FISO	U23
Female Wing Nut to Female Pipe	U18	ISO Style to Int'l Harvester Old Style	U24
12FQWH-12FP	U18	8MISO-8FIHC	U24
16FQWH-16FP	U18	ISO Style to John Deere Old Style - (Double Shutoff)	U24
20FQWH-20FP	U18	8MISO-8FJDDSO	U24
24FQWH-24FP	U18	ISO Style to Int'l Harvester Old Style - (Double Shutoff)	U24
32FQWH-32FP	U18	8MISO-8FIHCDSO	U24
Dust Plug	U18	<u>Two Way Block Style</u>	
12QWHDP	U18	Female Pipe NPTF	V1
16QWHDP	U18	4FP-4FPBV	V1
20QWHDP	U18	6FP-6FPBV	V1
24QWHDP	U18	8FP-8FPBV	V1
32QWHDP	U18	12FP-12FPBV	V1
Dust Cap	U19	16FP-16FPBV	V1
12QWHDC	U19	20FP-16FPBV	V1
16QWHDC	U19	Female O-Ring Boss	V1
20QWHDC	U19	4FB-4FBVB	V1
24QWHDC	U19	6FB-6FBVB	V1
32QWHDC	U19	8FB-8FBVB	V1
<u>G953 Series (Very High Pressure)</u>		12FB-12FBVB	V1
Male Poppet Valve to Female Pipe	U20	16FB-16FBVB	V1
6MQFFVH-6FP	U20	Code 61 O-Ring Flange	V1
Female Screw to Connect to Female Pipe	U20	8FL-8FLBV	V1
6FQFFVH-6FP	U20	12FL-12FLBV	V1
<u>G956 Series (Industrial ISO 7241 - Series A)</u>		16FL-16FLBV	V1
Male Poppet Valve to Female Pipe	U21	20FL-20FLBV	V1
4MQP-4FP	U21	24FL-24FLBV	V2
6MQP-6FP	U21	32FL-32FLBV	V2
8MQP-8FP	U21	Code 62 O-Ring Flange	V2
12MQP-12FP	U21	8FLH-8FLHBV	V2
16MQP-16FP	U21	12FLH-12FLHBV	V2
Female Poppet Valve to Female Pipe	U21	16FLH-16FLHBV	V2
4FQP-4FP	U21	20FLH-20FLHBV	V2
6FQP-6FP	U21	24FLH-24FLHBV	V2
12FQP-12FP	U21	32FLH-32FLHBV	V2
16FQP-16FP	U21	<u>Two Way Round Style Large ID</u>	
O-Ring	U21	Female Pipe NPTF	V3
4QDOR	U21	20FP-20FPBV	V3
6QDOR	U21	24FP-24FPBV	V3
8QDOR	U21	32FP-32FPBV	V3
12QDOR	U21	<u>Three Way Block Style</u>	
16QDOR	U21	Ball Valve Lock Out Kits	V4
Backup Ring	U22	1/4" THRU 1/2" BV LOCK OUT KIT	V4
4QDBR	U22	3/4" THRU 1" BV LOCK OUT KIT	V4
6QDBR	U22	1 1/4" THRU 2" BV LOCK OUT KIT	V4
8QDBR	U22	Female Pipe NPTF	V4
12QDBR	U22	4FP-4FP-4FPBV	V4
16QDBR	U22	6FP-6FP-6FPBV	V4
QD Dust Plug	U22		
4QDDP	U22		



Category	Page	Category	Page
<b>Three Way Block Style (Continued)</b>		<b>Live Swivel (Continued)</b>	
Female Pipe NPTF (Continued)	V4	ORS Seal Kit (Continued)	W4
8FP-8FP-8FPBV	V4	16ORS LIVE SWIVEL SEAL KIT	W4
12FP-12FP-12FPBV	V4		
16FP-16FP-16FPBV	V4	ORS/BSPP Seal Kit	W4
20FP-20FP-20FPBV	V4	8ORS/8BSPP LIVE SWVL SEAL KIT	W4
<b>Live Swivel</b>			
Male Pipe to Female Pipe - 90°	W1	Male ORFS to Female ORFS	W5
6MP-6FP-LX90	W1	12MFFOR-12FFORX-LX	W5
8MP-8FP-LX90	W1	16MFFOR-16FFORX-LX	W5
12MP-12FP-LX90	W1		
16MP-16FP-LX90	W1	Male ORFS to Male ORFS	W5
		8MFFOR-8MFFOR-LX	W5
Male BSPP to Male BSPP	W1	12MFFOR-12MFFOR-LX	W5
8BSPP-8BSPP-LX	W1	16MFFOR-16MFFOR-LX	W5
12BSPP-12BSPP-LX	W1		
16BSPP-16BSPP-LX	W1	<b>Assembly Fabrication</b>	
Male JIC to Male JIC	W1	Tube Assembly Equipment	X1
6MJ-6MJ-LX	W1	Bend-N-Fit Tube Bender	X1
8MJ-8MJ-LX	W1	Steel Power Steering & Transmission Oil Cooler Tubing - Male O-Ring	X1
12MJ-12MJ-LX	W1	24" - 5/16" Male O-Ring	X1
16MJ-16MJ-LX	W1	24" - 3/8" Male O-Ring	X1
20MJ-20MJ-LX	W1	24" - 7/16" Male O-Ring	X1
24MJ-24MJ-LX	W1	24" - 14mm Male O-Ring	X1
32MJ-32MJ-LX	W1	24" - 16mm Male O-Ring	X1
Male JIC to Male JIC - 90°	W2	Steel Power Steering & Transmission Oil Cooler Tubing - Male Inverted Flare	X1
6MJ-6MJ-LX90S	W2	24" - 3/8" Inverted Male Flare	X1
8MJ-8MJ-LX90	W2	24" - 14mm Male Inverted Flare	X1
8MJ-8MJ-LX90S	W2	24" - 16mm Male Inverted Flare	X1
12MJ-12MJ-LX90	W2	Steel Power Steering & Transmission Oil Cooler Tubing - Male SAE	X2
12MJ-12MJ-LX90S	W2	24" - 3/8" Male SAE	X2
16MJ-16MJ-LX90	W2	Steel Power Steering & Transmission Oil Cooler Tubing - Long Swivel O-Ring	X2
16MJ-16MJ-LX90S	W2	24" - 16mm Long Swivel O-Ring	X2
20MJ-20MJ-LX90	W2	Steel Power Steering & Transmission Oil Cooler Tubing - Swivel O-Ring Type I	X2
Male JIC to Female JIC/Boss	W2	24" - 3/8" Swivel O-Ring Type I	X2
8MJ-8FJ/FB-LX	W2	Steel Power Steering & Transmission Oil Cooler Tubing - Swivel O-Ring Type II	X2
12MJ-12FJ/FB-LX	W2	24" - 5/16" Swivel O-Ring Type II	X2
16MJ-16FJ/FB-LX	W2	Steel Power Steering & Transmission Oil Cooler Tubing - Swivel O-Ring Type III	X3
20MJ-20FJ/FB-LX	W2	24" - 16mm Swivel O-Ring Type III	X3
24MJ-24FJ/FB-LX	W2	Steel Power Steering & Transmission Oil Cooler Tubing - Male Captive O-Ring	X3
32MJ-32FJ/FB-LX	W2	24" - 12mm Male Captive O-Ring	X3
Male JIC to Female Boss - 90°	W2	Steel Power Steering & Transmission Oil Cooler Tubing - Captive O-Ring	X3
8MJ-8FB-LX90	W2	24" - 18mm Captive O-Ring	X3
12MJ-12FB-LX90	W2	Steel Power Steering & Transmission Oil Cooler Tubing - Female SAE	X4
16MJ-16FB-LX90	W3	24" - 3/8" Female SAE	X4
20MJ-20FB-LX90	W3	24" - 1/2" Female SAE	X4
Male Boss to Female JIC/Boss - 90°	W3	24" - 16mm Female SAE	X4
6MB-6FJ/FB-LX90S	W3	Steel Power Steering & Transmission Oil Cooler Tubing - Beaded Tube	X4
8MB-8FJ/FB-LX90S	W3	24" - 3/8" Beaded Tube	X4
12MB-12FJ/FB-LX90S	W3	Steel Power Steering & Transmission Oil Cooler Tubing - Male Single Bead Quick Connect	X4
16MB-16FJ/FB-LX90S	W3	24" - 3/8" Male Single Bead Quick Connect	X4
JIC Seal Kit	W3	Steel Power Steering & Transmission Oil Cooler Tubing - Double Beaded Pipe	X4
6JIC SWIVEL SEAL KIT	W3	24" - 3/8" Double Beaded Pipe	X4
8JIC SWIVEL SEAL KIT	W3	Steel Power Steering & Transmission Oil Cooler Tubing - GM Quick Connect	X5
12JIC SWIVEL SEAL KIT	W3	24" - 3/8" GM Quick Connect	X5
16JIC SWIVEL SEAL KIT	W3	Aluminum Air Conditioning Tubing - Male Tube O-Ring	X5
20JIC SWIVEL SEAL KIT	W3	24" - 3/8" Male Tube O-Ring	X5
24JIC SWIVEL SEAL KIT	W3	24" - 1/2" Male Tube O-Ring	X5
32JIC SWIVEL SEAL KIT	W3	Aluminum Air Conditioning Tubing - Male SAE	X5
Male JIC to Female Pipe	W3	24" - 3/8" Male SAE	X5
8MJ-8FP-LX	W3	24" - 1/2" Male SAE	X5
12MJ-12FP-LX	W3	Aluminum Air Conditioning Tubing - Male Inverted O-Ring	X5
16MJ-16FP-LX	W3	24" - 3/8" Male Inverted O-Ring	X5
Male Boss to Female Pipe - 90°	W4	24" - 1/2" Male Inverted O-Ring	X5
6MB-6FP-LX90S	W4	Aluminum Air Conditioning Tubing - Female Tube O-Ring	X6
8MB-8FP-LX90S	W4	24" - 3/8" Female Tube O-Ring	X6
12MB-12FP-LX90S	W4	24" - 1/2" Female Tube O-Ring	X6
16MB-16FP-LX90S	W4	24" - 16mm Female Tube O-Ring	X6
Male Boss to Male JIC - 90°	W4	24" - 18mm Female Tube O-Ring	X6
6MB-6MJ-LX90S	W4	24" - 20mm Female Tube O-Ring	X6
8MB-8MJ-LX90S	W4	Aluminum Air Conditioning Tubing - Female SAE	X6
12MB-12MJ-LX90S	W4	24" - 3/8" Female SAE	X6
16MB-16MJ-LX90S	W4		
ORS Seal Kit	W4		
12ORS LIVE SWIVEL SEAL KIT	W4		



Category	Page	Category	Page
<b>Assembly Fabrication (Continued)</b>		<b>Nylon Protective Sleeve (Continued)</b>	
Aluminum Air Conditioning Tubing - Female SAE (Continued)	X6	Nylon Protective Sleeve (Continued)	Y3
24" - 1/2" Female SAE	X6	HG-46	Y3
Aluminum Air Conditioning Tubing - Male Ford Spring Lock	X6	HG-64	Y3
24" - 3/8" Male Ford Spring Lock	X6	HG 14 X25FT	Y3
24" - 1/2" Male Ford Spring Lock	X6	HG 16 X25FT	Y3
Aluminum Air Conditioning Tubing - Female Ford Spring Lock	X7	HG 20 X25FT	Y3
24" - 3/8" Female Ford Spring Lock	X7	HG 24 X25FT	Y3
24" - 1/2" Female Ford Spring Lock	X7	HG 26 X25FT	Y3
<b>Nylon Protective Sleeve</b>		HG 28 X25FT	Y3
LifeGuard® Tools	Y1	HG 32 X25FT	Y3
LifeGuard Sleeve Guide Table	Y1	HG 38 X25FT	Y3
LifeGuard Sleeve Bullets -4, -6, -8	Y1	<b>Hose Guards</b>	
LifeGuard® 3000, 4000 and 5000	Y1	PolySleeve™ High Density Polyethylene Hose Wrap	Y4
14LG3K	Y1	6PSB POLY SLEEVE	Y4
16LG3K	Y1	8PSB POLY SLEEVE	Y4
20LG3K	Y1	12PSB POLY SLEEVE	Y4
22LG3K	Y1	16PSB POLY SLEEVE	Y4
26LG3K	Y1	20PSB POLY SLEEVE	Y4
32LG3K	Y1	24PSB POLY SLEEVE	Y4
14LG4K	Y1	28PSB POLY SLEEVE	Y4
16LG4K	Y1	36PSB POLY SLEEVE	Y4
20LG4K	Y1	44PSB POLY SLEEVE	Y4
22LG4K	Y1	48PSB POLY SLEEVE	Y4
26LG4K	Y1	56PSB POLY SLEEVE	Y4
32LG4K	Y1	72PSB POLY SLEEVE	Y4
14LG5K	Y1	6PSY POLY SLEEVE	Y4
16LG5K	Y1	8PSY POLY SLEEVE	Y4
20LG5K	Y1	12PSY POLY SLEEVE	Y4
22LG5K	Y1	16PSY POLY SLEEVE	Y4
26LG5K	Y1	20PSY POLY SLEEVE	Y4
LifeGuard® Clamp Collars - Stainless Steel	Y1	24PSY POLY SLEEVE	Y4
6SC-4-SS	Y1	28PSY POLY SLEEVE	Y4
8SC-4-SS	Y1	36PSY POLY SLEEVE	Y4
10SC-4-SS	Y1	44PSY POLY SLEEVE	Y4
12SC-4-SS	Y1	48PSY POLY SLEEVE	Y4
16SC-5-SS	Y1	56PSY POLY SLEEVE	Y4
Clamp Collar for Nylon Sleeve and LifeGuard® Sleeve	Y2	Plastic Protective Coil Sleeves	Y5
4SC-1	Y2	1/4" CS1151-100FT	Y5
4SC-1 XBULK	Y2	3/8" CS1152-100FT	Y5
6SC-1	Y2	1/2" CS1153-100FT	Y5
6SC-1 XBULK	Y2	5/8" CS1154-50FT	Y5
8SC-1	Y2	3/4" CS1155-50FT	Y5
8SC-1 XBULK	Y2	1" CS1156-50FT	Y5
10SC-1	Y2	1 3/8" CS1157-25FT	Y5
10SC-1 XBULK	Y2	1 7/8" CS1158-25FT	Y5
12SC-1	Y2	Plated Flat Armor Spring Guards	Y5
12SC-1 XBULK	Y2	35/64" FSG-25FT	Y5
16SC-2 XBULK	Y2	21/32" FSG-25FT	Y5
4SC-2 XBULK	Y2	39/64" FSG-25FT	Y5
10SC-2	Y2	22/32" FSG-25FT	Y5
10SC-2 XBULK	Y2	13/16" FSG-25FT	Y5
12SC-2	Y2	51/64" FSG-25FT	Y5
12SC-2 XBULK	Y2	7/8" FSG-25FT	Y5
6SC-3	Y2	61/64" FSG-25FT	Y5
6SC-3 XBULK	Y2	1" FSG-25FT	Y5
6SC-4	Y2	1 3/32" FSG-25FT	Y5
6SC-4 XBULK	Y2	1 7/32" FSG-25FT	Y5
8SC-4	Y2	1 9/32" FSG-25FT	Y5
8SC-4 XBULK	Y2	1 3/8" FSG-25FT	Y5
10SC-4	Y2	1 9/16" FSG-25FT	Y5
10SC-4 XBULK	Y2	1 5/8" FSG-25FT	Y5
12SC-4	Y2	1 11/16" FSG-5FT	Y6
12SC-4 XBULK	Y2	1 51/64" FSG-15FT	Y6
16SC-4	Y2	1 27/32" FSG-15FT	Y6
Nylon Protective Sleeve	Y3	2 3/32" FSG-10FT	Y6
HG-10	Y3	2 11/32" FSG-5FT	Y6
HG-14	Y3	2 7/8" FSG-5FT	Y6
HG-16	Y3	Plated Wire Spring Guards	Y6
HG-20	Y3	35/64" RSG-25FT	Y6
HG-24	Y3	49/64" RSG-25FT	Y6
HG-26	Y3	11/16" RSG-25FT	Y6
HG-28	Y3	47/64" RSG-25FT	Y6
HG-32	Y3	55/64" RSG-25FT	Y6
HG-38	Y3	59/64" RSG-25FT	Y6
HG-42	Y3	63/64" RSG-25FT	Y6
	Y3	1 3/64" RSG-25FT	Y6
	Y3	1 1/8" RSG-25FT	Y6



Category	Page	Category	Page
<b>Hose Guards (Continued)</b>		<b>Flange Fittings</b>	
Plated Wire Spring Guards (Continued)	Y6	Code 61 Flange Cap	Y11
1 9/32" RSG-25FT	Y6	12FL-CAP	Y11
1 11/32" RSG-25FT	Y6	16FL-CAP	Y11
1 37/64" RSG-25FT	Y6	20FL-CAP	Y11
1 5/8" RSG-25FT	Y6	24FL-CAP	Y11
1 27/32" RSG-10FT	Y6	32FL-CAP	Y11
2 1/8" RSG-7FT	Y6	Flange Half Sets (Code 61 - SAE J518)	Y11
2 7/64" RSG-7FT	Y6	8CFHS	Y11
<b>HeatGuard®</b>		12CFHS	Y11
HeatGuard® Tape	Y7	16CFHS	Y11
HTG-1" Wide HeatGuard Tape	Y7	20CFHS	Y11
HTG-2" Wide HeatGuard Tape	Y7	24CFHS	Y11
HTG-3" Wide HeatGuard Tape	Y7	32CFHS	Y11
HTG-4" Wide HeatGuard Tape	Y7	40CFHS	Y11
HTG-5" Wide HeatGuard Tape	Y7	48CFHS	Y11
HeatGuard® Protective Sheathing	Y7	56CFHS	Y11
HTG-4	Y7	64CFHS	Y11
HTG-5	Y7	Code 62 Flange Cap	Y12
HTG-6	Y7	12FLH-CAP	Y12
HTG-7	Y7	16FLH-CAP	Y12
HTG-8	Y7	20FLH-CAP	Y12
HTG-9	Y7	24FLH-CAP	Y12
HTG-10	Y7	32FLH-CAP	Y12
HTG-11	Y7	Flange Half Sets (Code 62 - SAE J518)	Y12
HTG-12	Y7	8FHHS	Y12
HTG-13	Y7	12FHHS	Y12
HTG-14	Y7	16FHHS	Y12
HTG-15	Y7	20FHHS	Y12
HTG-16	Y7	24FHHS	Y12
HTG-18	Y8	32FHHS	Y12
HTG-20	Y8	Caterpillar-Style Flange Half Sets	Y13
HTG-22	Y8	12CATFHS	Y13
HTG-24	Y8	16CATFHS	Y13
HTG-26	Y8	20CATFHS	Y13
HTG-28	Y8	24CATFHS	Y13
HTG-30	Y8	32CATFHS	Y13
HTG-32	Y8	<b>O-Rings</b>	
HTG-34	Y8	O-Rings for Straight Thread Boss Fittings	Y14
HTG-36	Y8	3 O-RING	Y14
HTG-38	Y8	4 O-RING	Y14
HTG-40	Y8	5 O-RING	Y14
HTG-44	Y8	6 O-RING	Y14
HTG-56	Y8	8 O-RING	Y14
HTG-64	Y8	10 O-RING	Y14
HeatGuard® High-Temp Protective Sheathing	Y8	12 O-RING	Y14
24-HTGH	Y8	14 O-RING	Y14
28-HTGH	Y8	16 O-RING	Y14
34-HTGH	Y8	20 O-RING	Y14
52-HTGH	Y8	O-Rings for Flat-Face Fittings	Y14
<b>Gates OE-Style Clamp Collars</b>		4 O-RING FF	Y14
Clamp Collars	Y9	6 O-RING FF	Y14
CC1.12	Y9	8 O-RING FF	Y14
CC1.20	Y9	10 O-RING FF	Y14
CC1.25	Y9	12 O-RING FF	Y14
CC1.37	Y9	16 O-RING FF	Y14
<b>Vinyl Bend Restrictor</b>		20 O-RING FF	Y14
Vinyl Bend Restrictor	Y10	24 O-RING FF	Y14
HBR1051	Y10	O-Rings for Code 61, Code 62, and Caterpillar-Style Flange Fittings	Y15
HBR1051 XBULK	Y10	8 FLANGE O-RING	Y15
HBR1052	Y10	10 FLANGE O-RING	Y15
HBR1052 XBULK	Y10	12 FLANGE O-RING	Y15
HBR1053	Y10	16 FLANGE O-RING	Y15
HBR1053 XBULK	Y10	20 FLANGE O-RING	Y15
HBR1050	Y10	24 FLANGE O-RING	Y15
HBR1050 XBULK	Y10	32 FLANGE O-RING	Y15
HBR1054	Y10	40 FLANGE O-RING	Y15
HBR1054 XBULK	Y10	48 FLANGE O-RING	Y15
HBR1056	Y10	56 FLANGE O-RING	Y15
HBR1055	Y10	64 FLANGE O-RING	Y15
HBR1055 XBULK	Y10	O-Rings for British Standard Parallel Pipe (BSPP Couplings)	Y15
HBR1098	Y10	4 O-RING FBSPP	Y15
HBR1098 XBULK	Y10	6 O-RING FBSPP	Y15
HBR1097	Y10	8 O-RING FBSPP	Y15
HBR1097 XBULK	Y10	10 O-RING FBSPP	Y15
	Y10	12 O-RING FBSPP	Y15



Category	Page	Category	Page
<b>O-Rings (Continued)</b>		<b>Tube Nuts and Sleeves (Continued)</b>	
O-Rings for British Standard Parallel Pipe (BSPP Couplings) (Continued)	Y15	Locknuts for Bulkhead Fittings (Continued)	Y19
16 O-RING FBSPP	Y15	5LN	Y19
20 O-RING FBSPP	Y15	6LN-SH	Y19
O-Rings for DIN Light & Heavy Series (MegaCrimp® and GlobalSpiral™ Couplings)	Y16	8LN-SH	Y19
18 O-RING DIN L	Y16	10LN-SH	Y19
22 O-RING DIN L	Y16	16LN-SH	Y19
28 O-RING DIN L	Y16	SAE Tubing Sleeve Nut	Y19
35 O-RING DIN L	Y16	4STSN	Y19
42 O-RING DIN L	Y16	5STSN	Y19
6 O-RING DIN H	Y16	6STSN	Y19
8 O-RING DIN H	Y16	8STSN	Y19
10 O-RING DIN H	Y16	10STSN	Y19
12 O-RING DIN H	Y16	12STSN	Y19
14 O-RING DIN H	Y16	Metric Bite Sleeve	Y19
15/16 O-RING DIN L/H	Y16	6BS	Y19
20 O-RING DIN H	Y16	8BS	Y19
25 O-RING DIN H	Y16	10BS	Y20
30 O-RING DIN H	Y16	12BS	Y20
38 O-RING DIN H	Y16	14BS	Y20
O-Rings for DIN Heavy Series (MegaCrimp® and GlobalSpiral™ Couplings)	Y16	15BS	Y20
8 O-RING DIN H	Y16	16BS	Y20
10 O-RING DIN H	Y16	18BS	Y20
12 O-RING DIN H	Y16	20BS	Y20
14 O-RING DIN H	Y16	22BS	Y20
16 O-RING DIN H	Y16	25BS	Y20
20 O-RING DIN H	Y16	28BS	Y20
25 O-RING DIN H	Y16	30BS	Y20
30 O-RING DIN H	Y16	35BS	Y20
38 O-RING DIN H	Y16	38BS	Y20
		42BS	Y20
<b>Tube Nuts and Sleeves</b>		Metric Bite Nut	Y20
Female Flareless Nut	Y17	6MNL	Y20
4FFN	Y17	6MNLL	Y20
5FFN	Y17	8MNL	Y20
6FFN	Y17	10MNL	Y20
8FFN	Y17	12MNL	Y20
10FFN	Y17	15MNL	Y20
12FFN	Y17	18MNL	Y20
16FFN	Y17	22MNL	Y20
Female Flareless Sleeve	Y17	28MNL	Y20
4FFS	Y17	35MNL	Y20
5FFS	Y17	42MNL	Y20
6FFS	Y17	6MNH	Y20
8FFS	Y17	8MNH	Y20
10FFS	Y17	10MNH	Y20
12FFS	Y17	12MNH	Y20
16FFS	Y17	14MNH	Y20
Tube Sleeve	Y17	16MNH	Y20
3TS	Y17	20MNH	Y20
4TS	Y18	25MNH	Y20
5TS	Y18	30MNH	Y20
6TS	Y18	38MNH	Y20
8TS	Y18	<b>Diagnostic</b>	
10TS	Y18	Diagnostic Equipment	Y21
12TS	Y18	RFID BAND TAG - ORANGE	Y21
14TS	Y18	RFID KEY TAG - ORANGE	Y21
16TS	Y18	RFID LANYARD TAG 12 IN ORANGE	Y21
20TS	Y18	RFID LANYARD TAG 24 IN ORANGE	Y21
24TS	Y18	RFID LANYARD TAG 36 IN ORANGE	Y21
32TS	Y18	<b>Equipment and Parts</b>	
Tube Sleeve Nut	Y18	Gates GC®16XD™ Parts	Z1
2TSN	Y18	GC16XD Handle Assembly	Z1
3TSN	Y18	GC16XD Foam Filler	Z1
4TSN	Y18	GC16XD Die Tub	Z1
5TSN	Y18	QC Tool (QCT) GC16-XD	Z1
6TSN	Y18	GC16XD End Caps	Z1
6TSN XBULK	Y18	GC16XD Stand Off Assembly (Long Version)	Z1
8TSN	Y18	GC16XD Die Retainer Sets	Z1
10TSN	Y18	GC16XD Dial Vernier Assembly	Z1
12TSN	Y18	GC16XD Bracket Assembly	Z1
14TSN	Y18	GC16XD Start Up Kit	Z1
16TSN	Y18	MobileCrimp® 4-20 Positive Stop Spacers	Z1
20TSN	Y18	B1 Spacer, PS	Z1
32TSN	Y18	W1 Spacer, PS	Z1
Locknuts for Bulkhead Fittings	Y19	R1 Spacer, PS	Z1
4LN-SH	Y19		





Category	Page	Category	Page
<b>Equipment and Parts (Continued)</b>		<b>Equipment and Parts (Continued)</b>	
MobileCrimp® 4-20 Positive Stop Spacers (Continued)	Z1	GC®32 Parts (Continued)	Z3
B2 Spacer, PS	Z1	Valve Block Adapters	Z3
W2 Spacer, PS	Z1	Pilot Operated Check	Z3
R2 Spacer, PS	Z1	Quick Change Tool	Z3
B3 Spacer, PS	Z1	Dial Vernier	Z3
W3 Spacer, PS	Z1	Depth Stop	Z3
R3 Spacer, PS	Z1	Mirror	Z3
B4 Spacer, PS	Z1	Foot Pedal	Z3
W4 Spacer, PS	Z1	Control Panel Post	Z3
R4 Spacer, PS	Z1	Kicker Tubing (Upper)	Z3
B5 Spacer, PS	Z1	Kicker Tubing (Lower)	Z3
W5 Spacer, PS	Z1	Foam Fillers GC32-XD Set of 8	Z3
R5 Spacer, PS	Z1	Die Tubs	Z4
MobileCrimp® 4-20 Parts	Z1	Head Seal	Z4
Magnet for Handling Die Sets	Z1	Breather Cap	Z4
Stand	Z1	Kicker	Z4
Pivot Spacer	Z1	2 Position 3-Way Solenoid	Z4
Stand Clamp	Z2	Dial Vernier Locking Plate	Z4
Pivot Knob	Z2	Relief Valve	Z4
Positive Stop Pressure Plate	Z2	Back Press. Cont. Cartridge	Z4
DD Computer Pressure Plate	Z2	Oil Filter Element	Z4
Hose Assembly	Z2	Control Box CSA	Z4
Pusher	Z2	Surge Protector w/Hubbell Plug	Z4
Cover Plate	Z2	OTC Repair Kit GC32/96 series up to 2"	Z4
Seal Kit Includes: Seal, Washer and Backup Ring	Z2	GC96TS, TSi, GC32TSi Power Supply	Z4
DD Pressure Plate for 20G/MC38	Z2	GC96 GC32XD Transformer	Z4
Computer Cable	Z2	GC32 Inverter	Z4
Digital Dial Assy. Kit (To Upgrade PS)	Z2	Die Retention Plate Kit	Z4
Ball Plunger for Top of Cylinder	Z2	Gates GC®96 Parts	Z4
Die Spring	Z2	GC96TS Control Box with Potentiometer	Z4
Die Link	Z2	GC96TS Die Release Tool	Z4
Shoulder Screws	Z2	<b>Kits</b>	
Slydring for Piston	Z2	Kits	AA1
Tall Handle for DD	Z2	<b>Air Brake Hose Assemblies</b>	
Locking Pin	Z2	1/2" ID Hose with 1/2" Female SAE Swivel at Both Ends	AB1
Chain for Locking Pin	Z2	8AB-8FSX-8FSX-18	AB1
Cable Assy. for DD	Z2	8AB-8FSX-8FSX-24	AB1
DD Top Mt Contrl Kit (side to top mount)	Z2	8AB-8FSX-8FSX-30	AB1
DD Controller Top Mount	Z2	8AB-8FSX-8FSX-36	AB1
Retaining Ring for Piston	Z2	8AB-8FSX-8FSX-42	AB1
Power Crimp® 707 Parts	Z2	8AB-8FSX-8FSX-48	AB1
PC703 to PC707 Conversion Kit	Z2	8AB-8FSX-8FSX-60	AB1
Crimp Switch Button for PC603/PC707	Z2	AB-8FSX-8FSX-54	AB1
Piston New Design (Seals Included)	Z2	1/2" ID Hose with 3/8" Male Pipe NPTF Swivel at Both Ends	AB1
Piston Rod	Z2	8AB-6MPX-6MPX-08	AB1
Piston Rod Guide	Z2	8AB-6MPX-6MPX-12	AB1
Base Plate (Machine)	Z2	8AB-6MPX-6MPX-16	AB1
Tie Rod	Z2	8AB-6MPX-6MPX-20	AB1
Pusher Cup (update design)	Z2	8AB-6MPX-6MPX-24	AB1
Cylinder and Top Plate	Z2	8AB-6MPX-6MPX-28	AB1
Spring Anchor	Z2	8AB-6MPX-6MPX-32	AB1
Mounting Bracket	Z2	8AB-6MPX-6MPX-36	AB1
O-Ring Between Piston and Rod	Z2	8AB-6MPX-6MPX-42	AB1
Actuator Rod	Z2	8AB-6MPX-6MPX-48	AB1
Die Cone With Notch	Z3	8AB-6MPX-6MPX-54	AB1
Tie Rod Nut	Z3	8AB-6MPX-6MPX-60	AB1
Switch Box Complete w/115V Cord Assy.	Z3	8AB-6MPX-6MPX-66	AB1
Digital Readout Meter	Z3	8AB-6MPX-6MPX-72	AB1
PC707 Shroud Only	Z3	8AB-6MPX-6MPX-84	AB1
PC707 Hose Assy. (Pump to Crimper)	Z3	3/8" ID Hose with 1/4" Male Pipe NPTF Swivel at Both Ends	AB1
Magnet for Removing Dies	Z3	6AB-4MPX-4MPX-08	AB1
Die Cone (No Notch)	Z3	6AB-4MPX-4MPX-12	AB1
Microswitch	Z3	6AB-4MPX-4MPX-16	AB2
230V Cord Assy. for Digital Readout	Z3	6AB-4MPX-4MPX-20	AB2
PC707 230V Converter Kit	Z3	6AB-4MPX-4MPX-24	AB2
115V Cord Assy for Digital Readout	Z3	6AB-4MPX-4MPX-28	AB2
Die Cage Halves (Set of 2) for 700 Series	Z3	6AB-4MPX-4MPX-32	AB2
Stainless Steel Washer	Z3	6AB-4MPX-4MPX-36	AB2
Die Cage Halves for 739	Z3	6AB-4MPX-4MPX-42	AB2
PC707 Seal Kit for New Aluminum Piston Serial Nos. 14,000 and Up	Z3	6AB-4MPX-4MPX-48	AB2
Silver Die Back Up Ring	Z3	6AB-4MPX-4MPX-52	AB2
LifeGuard Plate	Z3	6AB-4MPX-4MPX-60	AB2
LifeGuard Plate and Die Kit	Z3	6AB-4MPX-4MPX-66	AB2
Screw for Die Fingers	Z3	6AB-4MPX-4MPX-72	AB2
Molykote 3 oz. Jar G Die Lubricant	Z3	6AB-4MPX-4MPX-84	AB2
Piston Return Spring for PC707/3000B	Z3		
GC®32 Parts	Z3		
Head Replacement Kit	Z3		
Panel Replacement Kit	Z3		



Category	Page	Category	Page
<b>Air Brake Hose Assemblies (Continued)</b>		<b>Air Brake Couplings For Rubber Hose (Continued)</b>	
3/8" ID Hose with 3/8" Male Pipe NPTF Swivel at Both Ends	AB2	Air Brake to Female Air Brake Swivel with Adapter	AC6
6AB-6MPX-6MPX-08	AB2	6ABR-6FABX-4MPA	AC6
6AB-6MPX-6MPX-12	AB2	6ABR-6FABX-6MPA	AC6
6AB-6MPX-6MPX-16	AB2	6ABR-8FABX-8MPA	AC6
6AB-6MPX-6MPX-20	AB2	8ABR-6FABX-6MPA	AC6
6AB-6MPX-6MPX-24	AB2	Air Brake Union	AC6
6AB-6MPX-6MPX-28	AB2	6ABR-6ABR	AC6
6AB-6MPX-6MPX-32	AB2	8ABR-8ABR	AC6
6AB-6MPX-6MPX-36	AB2	Brass Lock-On Field Attachable Couplings for LOC & LOL Hose	
6AB-6MPX-6MPX-42	AB2	Male Pipe with Cone Seat	AC8
6AB-6MPX-6MPX-45	AB2	4LOC-2RMP	AC8
6AB-6MPX-6MPX-48	AB2	4LOC-4RMP	AC8
6AB-6MPX-6MPX-52	AB2	4LOC-6RMP	AC8
6AB-6MPX-6MPX-60	AB2	5LOC-2RMP	AC8
6AB-6MPX-6MPX-66	AB2	5LOC-4RMP	AC8
6AB-6MPX-6MPX-72	AB2	6LOC-2RMP	AC8
6AB-6MPX-6MPX-84	AB2	6LOC-4RMP	AC8
3/8" ID Hose with 3/8" Female SAE Swivel at Both Ends	AB3	6LOC-6RMP	AC8
6AB-6FSX-6FSX-18	AB3	6LOC-8RMP	AC8
6AB-6FSX-6FSX-24	AB3	8LOC-4RMP	AC8
6AB-6FSX-6FSX-30	AB3	8LOC-6RMP	AC8
6AB-6FSX-6FSX-36	AB3	8LOC-8RMP	AC8
6AB-6FSX-6FSX-42	AB3	8LOC-12RMP	AC8
6AB-6FSX-6FSX-48	AB3	10LOC-6RMP	AC8
6AB-6FSX-6FSX-54	AB3	10LOC-8RMP	AC8
6AB-6FSX-6FSX-60	AB3	10LOC-12RMP	AC8
<b>Air Brake Couplings For Rubber Hose</b>		12LOC-8RMP	AC8
Male Air Brake to Male Pipe Adapter	AC2	12LOC-12RMP	AC8
6MAB-4MP	AC2	Male Pipe Swivel without Cone Seat	AC8
6MAB-6MP	AC2	4LOC-4RMPX	AC8
6MAB-8MP	AC2	6LOC-6RMPX	AC8
8MAB-6MP	AC2	8LOC-8RMPX	AC8
8MAB-8MP	AC2	12LOC-12RMPX	AC8
Gladhand	AC2	Male Pipe 90° Block with Cone Seat	AC9
8GH-S	AC2	4LOC-2RMP90	AC9
8GH-U	AC2	4LOC-4RMP90	AC9
8GH-E	AC2	5LOC-2RMP90	AC9
Gladhand Seal	AC3	5LOC-4RMP90	AC9
6GH-SEAL	AC3	6LOC-2RMP90	AC9
Sleeve	AC3	6LOC-4RMP90	AC9
6TS-6ABR	AC3	6LOC-6RMP90	AC9
8TS-8ABR	AC3	8LOC-8RMP90	AC9
Nut	AC3	12LOC-12RMP90	AC9
6TSN-6ABR	AC3	Female Pipe without Cone Seat	AC9
8TSN-8ABR	AC3	4LOC-4RFP	AC9
Spring Guard Nut	AC4	5LOC-4RFP	AC9
6SGN-6ABR	AC4	6LOC-6RFP	AC9
8SGN-8ABR	AC4	8LOC-6RFP	AC9
Air Brake to Male Pipe with Nut and Sleeve	AC4	8LOC-8RFP	AC9
6ABR-4MP	AC4	10LOC-8RFP	AC9
6ABR-6MP	AC4	12LOC-12RFP	AC9
6ABR-8MP	AC4	Female Pipe Swivel with Cone Seat	AC10
8ABR-6MP	AC4	4LOC-2RFPX	AC10
8ABR-8MP	AC4	4LOC-4RFPX	AC10
Air Brake to Male Pipe with Spring Guard	AC5	4LOC-6RFPX	AC10
6ABRSG-4MP	AC5	6LOC-4RFPX	AC10
6ABRSG-6MP	AC5	6LOC-6RFPX	AC10
6ABRSG-8MP	AC5	8LOC-8RFPX	AC10
8ABRSG-6MP	AC5	8LOC-12RFPX	AC10
8ABRSG-8MP	AC5	10LOC-12RFPX	AC10
Air Brake to Male Pipe without Nut and Sleeve	AC5	12LOC-12RFPX	AC10
6ABRI-4MP	AC5	Male JIC 37° Flare	AC10
6ABRI-6MP	AC5	4LOC-4RMJ	AC10
6ABRI-8MP	AC5	4LOC-5RMJ	AC10
8ABRI-6MP	AC5	4LOC-6RMJ	AC10
8ABRI-8MP	AC5	6LOC-4RMJ	AC10
Air Brake Spring Guard	AC5	6LOC-5RMJ	AC10
6SGABR	AC5	6LOC-6RMJ	AC10
8SGABR	AC5	6LOC-8RMJ	AC10
Air Brake to Female Air Brake Swivel	AC6	8LOC-8RMJ	AC10
6ABR-6FABX	AC6	8LOC-10RMJ	AC10
8ABR-8FABX	AC6	10LOC-8RMJ	AC10
		10LOC-10RMJ	AC10
		12LOC-10RMJ	AC10





Category	Page	Category	Page
<b>Brass Lock-On Field Attachable Couplings for LOC &amp; LOL Hose (Continued)</b>		<b>Single Bead</b>	
Male JIC 37° Flare (Continued)	AC10	Male Pipe with Cone Seat	AC17
12LOC-12RMJ	AC10	3SB-2RMP	AC17
Female JIC 37° Flare Swivel	AC11	4SB-2RMP	AC17
4LOC-6RFJX	AC11	4SB-4RMP	AC17
6LOC-6RFJX	AC11	5SB-2RMP	AC17
12LOC-12RFJX	AC11	5SB-4RMP	AC17
Male SAE 45° Flare	AC11	6SB-2RMP	AC17
4LOC-4RMS	AC11	6SB-4RMP	AC17
4LOC-5RMS	AC11	6SB-6RMP	AC17
4LOC-6RMS	AC11	8SB-6RMP	AC17
5LOC-5RMS	AC11	8SB-8RMP	AC17
6LOC-4RMS	AC11	10SB-6RMP	AC17
6LOC-5RMS	AC11	10SB-8RMP	AC17
6LOC-6RMS	AC11	10SB-12RMP	AC17
6LOC-8RMS	AC11	12SB-8RMP	AC17
8LOC-8RMS	AC11	12SB-12RMP	AC17
8LOC-10RMS	AC11	Male Straight Thread Connector	AC17
10LOC-8RMS	AC11	6SB-9MSC	AC17
10LOC-10RMS	AC11	6SB-10MSC	AC17
12LOC-10RMS	AC11	6SB-14MSC	AC17
12LOC-12RMS	AC11	Male Pipe 90° Block Cone Seat	AC18
Female SAE 45° Flare Swivel	AC12	4SB-2RMP90	AC18
4LOC-6RFSX	AC12	5SB-2RMP90	AC18
5LOC-6RFSX	AC12	5SB-4RMP90	AC18
6LOC-6RFSX	AC12	6SB-2RMP90	AC18
8LOC-6RFSX	AC12	6SB-4RMP90	AC18
12LOC-12RFSX	AC12	6SB-6RMP90	AC18
Dual Seat Female JIC 37°/SAE 45° Flare Swivel	AC12	8SB-6RMP90	AC18
4LOC-4RFJSX	AC12	8SB-8RMP90	AC18
4LOC-5RFJSX	AC12	10SB-6RMP90	AC18
5LOC-5RFJSX	AC12	10SB-8RMP90	AC18
6LOC-5RFJSX	AC12	12SB-8RMP90	AC18
6LOC-8RFJSX	AC12	Male SAE 45° Flare Connector	AC18
8LOC-8RFJSX	AC12	6SB-5RMS	AC18
8LOC-10RFJSX	AC12	6SB-6RMS	AC18
10LOC-10RFJSX	AC12	Male SAE Inverted Flare Swivel	AC19
12LOC-10RFJSX	AC12	4SB-4RMIX	AC19
Male SAE Inverted Flare Swivel	AC13	4SB-5RMIX	AC19
4LOC-3RMIX	AC13	5SB-4RMIX	AC19
4LOC-4RMIX	AC13	5SB-5RMIX	AC19
4LOC-5RMIX	AC13	5SB-6RMIX	AC19
5LOC-4RMIX	AC13	6SB-5RMIX	AC19
5LOC-5RMIX	AC13	6SB-6RMIX	AC19
5LOC-6RMIX	AC13	Male SAE Inverted Flare Swivel - 45°	AC19
6LOC-5RMIX	AC13	6SB-5RMIX45	AC19
6LOC-6RMIX	AC13	Male SAE Inverted Flare Swivel - 90°	AC20
6LOC-8RMIX	AC13	4SB-4RMIX90	AC20
8LOC-6RMIX	AC13	4SB-5RMIX90	AC20
8LOC-8RMIX	AC13	5SB-6RMIX90	AC20
10LOC-10RMIX	AC13	6SB-5RMIX90	AC20
Female SAE Inverted Flare	AC13	6SB-6RMIX90	AC20
4LOC-3RFI	AC13	Female SAE Inverted Flare	AC20
4LOC-4RFI	AC13	5SB-5RFI	AC20
4LOC-5RFI	AC13	6SB-5RFI	AC20
5LOC-5RFI	AC13	6SB-6RFI	AC20
6LOC-5RFI	AC13		
6LOC-6RFI	AC13	<b>Barb Stem</b>	
8LOC-8RFI	AC13	Male Pipe NPTF with Cone Seat	AC22
North American Stand Pipe	AC14	2BS-2MP	AC22
4LOC-3RFT	AC14	3BS-2MP	AC22
4LOC-4RFT	AC14	3BS-4MP	AC22
4LOC-5RFT	AC14	4BS-2MP	AC22
5LOC-5RFT	AC14	4BS-4MP	AC22
6LOC-6RSP	AC14	4BS-6MP	AC22
8LOC-8RSP	AC14	5BS-2MP	AC22
10LOC-10RSP	AC14	5BS-4MP	AC22
Hose Length Extenders	AC14	6BS-2MP	AC22
4LOC-4RHM	AC14	6BS-4MP	AC22
5LOC-5RHM	AC14	6BS-6MP	AC22
6LOC-6RHM	AC14	6BS-8MP	AC22
8LOC-8RHM	AC14	8BS-4MP	AC22
10LOC-10RHM	AC14	8BS-6MP	AC22
12LOC-12RHM	AC14	8BS-8MP	AC22
Male British Standard Pipe Tapered	AC15	8BS-12MP	AC22
5LOC-4MBSPT	AC15	10BS-6MP	AC22
		10BS-8MP	AC22



<u>Category</u>	<u>Page</u>
<u>Barb Stem (Continued)</u>	
Male Pipe NPTF with Cone Seat (Continued)	AC22
10BS-12MP	AC22
12BS-8MP	AC22
12BS-12MP	AC22
Female Pipe NPTF	AC22
2BS-2FP	AC22
3BS-2FP	AC22
4BS-2FP	AC22
4BS-4FP	AC22
5BS-2FP	AC22
5BS-4FP	AC22
6BS-2FP	AC22
6BS-4FP	AC22
6BS-6FP	AC22
8BS-4FP	AC22
8BS-6FP	AC22
8BS-8FP	AC23



**DRIVEN BY POSSIBILITY™**



Automotive 431-2080  
Industrial 35093



Please recycle this catalog!

Printed in the U.S.A.

For more information on Gates Hydraulic hose,  
visit [www.gates.com/hydraulics](http://www.gates.com/hydraulics)

For in-depth technical support, contact  
Gates Industrial Technical & Engineering Support  
at 303.744.5070 or [pa0000@gates.com](mailto:pa0000@gates.com)

Gates Industrial Corporation  
1144 15th Street, Suite 1400  
Denver, CO 80202, U.S.A.  
303.744.1911