



DRIVEN BY POSSIBILITY™

# SAFE HYDRAULICS™

## HYDRAULIC HOSE + COUPLINGS

SAFETY, PREVENTIVE MAINTENANCE, TROUBLESHOOTING,  
COUPLING IDENTIFICATION + SELECTION, ASSEMBLY, AND  
INSTALLATION.



# TABLE OF CONTENTS



<b>INTRODUCTION</b> .....	<b>3</b>	<b>COUPLING SELECTION</b> .....	<b>36</b>
Why Preventive Maintenance? .....	3	Identification Tools .....	36
Benefits .....	4	Coupling Identification .....	36
Components of a Preventive Maintenance Program .....	4	Measuring Threads and Seat Angles .....	37
Fluid Power Technology .....	5	North American Standards .....	38
		British Standards .....	39
		Japanese Standards .....	40
		German Standards .....	40
		French Standards .....	41
		Gates Coupling Nomenclature .....	42
		Additional Selection Criteria .....	44
<b>SAFETY</b> .....	<b>6</b>	<b>PROPER HOSE ASSEMBLY</b> .....	<b>45</b>
Maintaining a Safe Work Environment .....	6	Measuring and Cutting Hose .....	45
Safe Hose Selection .....	8	Hose Preparation .....	47
Safe Coupling Selection .....	8	Crimp Procedures .....	47
Safe Hose Assembly .....	8	Field Attachable Procedures .....	49
Safe Installation .....	9	Hose Cleanliness .....	49
Maintenance .....	9		
		<b>INSTALLING HOSE ASSEMBLIES</b> .....	<b>52</b>
<b>PERIODIC INSPECTIONS</b> .....	<b>10</b>	Coupling Configurations .....	52
When to Inspect and How Often .....	10	Seven Easy Steps to Install a Hose Assembly .....	54
Inspection Procedure .....	10	Hose Assembly Routing Tips .....	55
<b>SLAM</b> Risks the <b>SMART</b> Way .....	11	Assembly Techniques and Accessories .....	57
		Coupling and Adapter Installation: Flats Method .....	58
		Coupling and Adapter Installation: Torque Table .....	58
<b>HOSE RISK MANAGEMENT</b> .....	<b>12</b>		
Components .....	12	<b>CRIMPER PREVENTIVE MAINTENANCE</b> .....	<b>59</b>
		Safety and Maintenance for Gates Crimpers .....	59
<b>TROUBLESHOOTING</b> .....	<b>14</b>	Crimper Setup .....	59
		Crimper Troubleshooting .....	60
<b>HOSE SELECTION</b> .....	<b>23</b>	eCrimp™ Database .....	60
Why Use Hose? .....	23		
Hose Construction .....	23	<b>GLOSSARY OF TERMS</b> .....	<b>62</b>
Hose Performance Characteristics .....	24		
Hose Selection .....	26		
Hose Nomenclature .....	28		
Characteristics of Hose Stock Types .....	30		
Agency Specifications .....	31		
Hydraulic Fluids .....	34		
Storage and Shelf Life Considerations .....	35		
Service Life Considerations .....	35		



## INTRODUCTION

# WHY PREVENTIVE MAINTENANCE?



**THERE ARE SEVERAL VALID REASONS TO BEGIN A PREVENTIVE MAINTENANCE PROGRAM. COSTLY EMERGENCY REPAIRS, PRODUCTION DOWNTIME AND WORKER SAFETY ARE JUST A FEW. THE MAIN OBJECTIVE OF A PREVENTIVE MAINTENANCE PROGRAM IS TO IDENTIFY COMPONENT WEAKNESSES BEFORE FAILURE AND LOSS OF PRODUCTION. SOME BELIEVE THAT PM ACTUALLY SHOULD MEAN “PREDICTIVE MAINTENANCE” RATHER THAN “PREVENTIVE MAINTENANCE.”**

Preventive maintenance is especially important with hydraulic products. The high pressures and temperatures associated with hydraulics make hose and fitting maintenance, as well as selection, critical. If done correctly, the risk of injury and/or excessive, costly downtime decreases significantly. In addition, there is a growing awareness regarding costs associated with cleaning up a hydraulic spill (EPA). Combining top-quality Gates products with a regular preventive maintenance program will keep your equipment operating at maximum efficiency.

### EXPERT ADVICE



Though this manual contains helpful suggestions, it is not an all-inclusive reference for implementing a preventive maintenance program.

The most effective program will also take into account your equipment manufacturer's recommendations, as well as your experience in using and maintaining the equipment. You should, however, contact Gates before doing anything contrary to recommendations in this manual or in other Gates literature.

You must also consult the equipment manufacturer for information regarding injury risks related to its equipment that may not be identified or fully discussed in this manual. In addition, Society of Automotive Engineers (SAE) recommended practice J1273\* contains many useful recommendations about design, installation, maintenance and other activities involving hose assemblies in hydraulic systems.

\* SAE documents are available through SAE Customer Service at:  
877-606-7323  
[www.sae.org/about/contact](http://www.sae.org/about/contact)



## BENEFITS

1. **Minimized safety hazards**
2. **Efficient production** because equipment is in good operating condition at all times
3. **Better use of in-shop maintenance personnel** since there's less emergency work and more scheduled work
4. **Improved control** of spare parts inventory, and reduced parts usage
5. **Reduction of equipment downtime** through scheduled inspections
6. **Increased life expectancy** of equipment
7. **Fewer capital outlays** for purchasing new equipment prematurely
8. **Reduced repair costs** due to fewer breakdowns
9. **Prevention of equipment deterioration** from causes other than obsolescence

## COMPONENTS OF A PREVENTIVE MAINTENANCE PROGRAM

An effective preventive maintenance program consists of the following key elements:

- Maintaining a safe work environment
- Complete and accurate maintenance records
- Regularly scheduled inspections conducted when equipment is shut down and hoses are not pressurized
- Troubleshooting (identifying problems and solutions)
- Proper hose and fitting selection
- Proper assembly, routing and installation
- Receiving updated maintenance and product training periodically



## FLUID POWER TECHNOLOGY

### QUESTIONS ANSWERED, PROBLEMS SOLVED

The Gates Customer Solutions Center (CSC) is staffed with top engineers, scientists and technicians whose sole mission is to meet the needs of the Gates fluid power customer. Problems with equipment? Need training? Application problems? The CSC is at your disposal.

### RESEARCH AND DEVELOPMENT

There is nothing static about the fluid power industry. By anticipating industry changes through research and development, Gates specialists work to improve fluid power productivity. Some search for better hose assemblies, while others address specific customer application problems. All are dedicated to advancing technologies that increase value in the marketplace.

### TESTING

At the CSC, the testing of existing assemblies or prototypes is intensive. The testing simulates real-world conditions. We freeze, heat, abrade, age and even expose materials to ozone. We evaluate metals and compounds. We examine designs for effectiveness and durability. The Impulse Test Lab is the most advanced of its kind in the industry. In short, we find out what works and what doesn't. If a product passes the tests at the CSC, you can be sure of its reliability.

### CUSTOMER TRAINING

When you or your company's personnel need technical training, there is no better place to get it than in the CSC's classrooms. At individual computer workstations and in mobile equipment bays, students work side by side with Gates professionals to learn about hose selection, crimping, routing and system design. Our training courses instruct customers in equipment maintenance, troubleshooting and safety. In our secure mobile equipment bay, we work with customers to design and develop new products. This high-quality, hands-on training is but one more value-added commitment to our customers.



## SAFETY

### MAINTAINING A SAFE WORK ENVIRONMENT

Establishing a safe working environment in and around your hydraulic equipment is vital. Safe Hydraulics training can lead to not only safety, but safe production. The easiest and most effective way to avoid problems is to make sure your associates understand their equipment, know how to operate it safely and recognize the danger it represents if handled carelessly.

A few things you must be aware of include:

**Pressure** – Hydraulic fluid under pressure is dangerous and can cause serious injury.

**Temperature** – Hot fluid can burn skin, eyes and ocular cavities.

**Flammability** – When ignited, some hydraulic fluids can explode and/or cause fires.

**Mechanical** – Hydraulic fluid creates movement, which causes parts of your equipment to move or rotate at high speeds and with great force. Moving components should be in a safe or neutral position.

**Electricity** – Electricity can create the spark that causes a fire, explosion or electrocution. Shut it down.

#### PRESSURE

Operating pressures of hydraulic systems can be up to 10,000 psi. Under pressure, hydraulic fluid can cause these dangers:

**Pinhole** – Fluid under pressure can cause serious injury. It can be almost invisible escaping from a pinhole, and it can pierce the skin into the body. Do not touch or get near a pressurized hydraulic hose assembly with any part of your body. If fluid punctures the skin, even if no pain is felt, a serious emergency exists. Seek medical assistance immediately. **Failure to do so can result in loss of the injured part or death.**

**Leak** – Leaking hydraulic fluid is not only unsightly, it's hazardous. In addition to making workplace floors slippery and dangerous, leaks also contaminate the environment. As little as one quart of oil can pollute up to 250,000 gallons of water. 100 million gallons of oil are estimated to leak from hydraulic equipment annually. Before cleaning an oil spill, always check EPA, state and local regulations.

**Burst** – Whether due to improper selection or damage, a ruptured hose can cause injury. If it bursts, a worker can be burned, cut, injected, or may slip and fall.

**Coupling Blowoff** – If the assembly isn't properly made or installed, the coupling could come off and hit or spray a worker, possibly resulting in serious injury.

**Whipping Hose** – If the hose end or end fitting comes apart under pressure, the loose hose can whip around with great force. This has the potential to cause serious injury. If this hazard exists, restrain or shield the hose using clamps or protective shielding.

**Stored Energy** – Hydraulic systems sometimes use accumulators to store potential energy or absorb shock. This energy can create pressure that keeps the system's components moving.

**REMEMBER:** Charged accumulators can be lethal. Always open the accumulator's valve to release pressure. Hoses under pressure act as accumulators.



Burst

<b>TEMPERATURE</b>	<p>Most hydraulic systems typically operate at 150° to 180°F (65° to 82°C). Others may go as high as 300°F (149°C). Liquid at these temperatures may burn skin. Metal parts (such as fittings and adapters) are also hot and may cause burns. Hoses can also become hot.</p>
<b>FLAMMABILITY</b>	<p>With the exception of those comprised primarily of water, all hydraulic fluids are flammable when exposed to the proper conditions (including many “fire-resistant” hydraulic fluids).</p> <p>Leaking pressurized hydraulic fluids may develop a mist or fine spray that can flash or explode upon contact with a source of ignition. These explosions can be very severe and could result in serious injury or death.</p> <p>Precautions should be taken to eliminate all ignition sources from contact with escaping fluids, sprays or mists resulting from hydraulic failures. Sources of ignition could include electrical discharges (sparks), open flames, extremely high temperatures, hot manifolds and engine blocks, sparks caused by metal-to-metal contact, etc.</p>
<b>MECHANICAL</b>	<p>Mechanical motion can be dangerous. Watch out for swinging arms, booms, rollers, presses—anything that moves can be dangerous if a hose fails. For example, when a hose bursts, objects supported by fluid pressure may fall, and vehicles or machines may lose their brakes. If the equipment is mobile, always chock the tires to prevent rolling.</p>
<b>ELECTRICITY</b>	<p>It’s important to turn hydraulic equipment off before starting to work on it. If plant equipment, lock the control box, and tag it with a warning sign stating “DOWN FOR MAINTENANCE. DO NOT TURN ON POWER.” If the equipment is mobile, take the key and/or disconnect the battery so it can’t be started.</p> <p>During normal equipment operation, you may be exposed to electrical hazards such as high-voltage power lines and underground power sources. Always identify these potential hazards before running the equipment. Most hydraulic hose is wire-reinforced, making it conductive to electricity.* Some equipment requires the use of non-conductive hose if there’s a chance of contacting power sources.</p> <p>OSHA standards require that all hydraulic tools used on or near energized power lines or equipment be supplied with non-conducting hose having adequate strength for normal operating pressures [29 CFR 1926.951(f)(3)]. Faulty wiring can also be an electrical hazard. A regular preventive maintenance program should always include a wiring check.</p> <p>* Even non-wire-reinforced hose may be conductive through the rubber compound itself or moisture that penetrates a pin-pricked hose cover.</p>

## EXPERT ADVICE



Equipment safety precautions include:

- Always wear safety glasses.
- Keep appendages clear from moving parts.
- Don't wear loose-fitting clothing.
- Make sure equipment is securely mounted and connected.
- Use new hoses and couplings (reference crimp manuals and eCrimp).

## SAFE HOSE SELECTION

Proper hose selection is critical to a safe hydraulic system. A simple rule of thumb for proper hose selection is the word “stamped”:

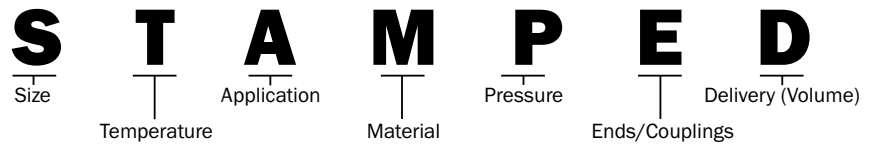

The first step in having a safe hydraulic system is selecting components that meet your needs. Compromises in hose selection may put you in danger, as well as affect the performance and life of your system. The decision may work for the short run but may not be a good long-term decision. Remember, the most important thing is your safety. Most hydraulic systems should be designed with a 4:1 safety factor (burst test pressure vs. maximum recommended working pressure). However, some applications may have different standards (examples: waterblast, jack hose). (See pages 26–28.)

## SAFE COUPLING SELECTION

Thread ends must be compatible in order to prevent leaking or assembly blowoff. Fittings seal three ways:

1. Thread interference
2. Mechanical joint or mated angle
3. O-rings

It's critical that both the male and female fittings are compatible to create an effective seal. Incorrect sealing can cause leaks, which can create a safety and environmental hazard. (See pages 36-44 for more details.)

Once the components have been selected, it's important that the assembly is made properly. If not, the ends could blow off.

## SAFE HOSE ASSEMBLY

Whether you're making it yourself or buying it ready-made, don't mix and match hose and couplings from various manufacturers. It's critical that the hose and coupling manufacturer are the same and that they're assembled using the manufacturer's recommended equipment, components and procedures and that the components are new, never reuse old components. Mixed combinations may not have been tested. SAE standard states that “SAE J517 hose from one manufacturer is usually not compatible with SAE J516 fittings supplied by another manufacturer.”

Gates has conducted extensive testing to verify the integrity of its products. For instance, an assembly with our MXG4K-XTP hose passes one million impulse cycles when tested at SAE 100R12 conditions with GlobalSpiral™ couplings.

That means not only is the product safe, but you'll receive maximum hose life as well. The key is using the recommended fitting and assembly procedures. If not followed, there's no telling how long the assembly will last. (See pages 45–51 for more details.)

If making your own assemblies, refer to the operating manual for that specific equipment (crimpers, cutters, swagers, etc.) for proper use.

\*There are certain couplings that utilize a mated angle and an O-ring for sealing.

## 1. Thread interface

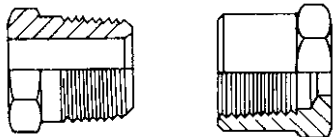

## 2. Mechanical joint or mated angle

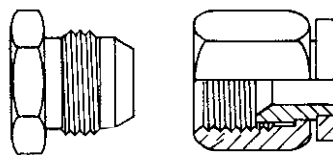

## 3. O-rings

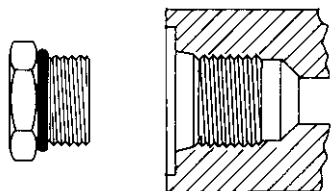



## SAFE INSTALLATION

It is important to pay particular attention to **hose routing** (see pages 55–56):

- Hose must be properly installed to prevent hazards and ensure long life
- Avoid twisting
- Avoid positioning hose next to heat sources
- Avoid positioning hose next to metal edges or too close to other hose. The hose cover and reinforcement may be damaged by abrasion, creating a safety problem
- Sleeving, clamping and abrasion-resistant products may be problem solvers

Proper **torquing** of fittings is also important:

- When connecting threaded or flanged ends, follow proper torque recommendations. Improperly torqued (both under-torqued or over-torqued) fittings may not only leak, but they may not withstand system pressure or vibration. (See page 58 for more details.)

## MAINTENANCE

A well-maintained machine is a productive machine. If not properly maintained, it could be unsafe and could break down. A scheduled maintenance program should ensure a long system life and a safe work environment. Refer to your equipment maintenance manual for recommendations.



## PERIODIC INSPECTIONS

### EXPERT ADVICE



Review safety precautions first prior to conducting any inspection of your hydraulic system.

It's important to understand the precautions outlined in pages 6–9, as well as specific precautions outlined by your equipment manufacturer.

### PREVENTIVE MAINTENANCE CHECKLIST

By following this preventive maintenance checklist, you can maintain your equipment's hoses efficiently, safely and with very little effort. Each step is covered in detail in the following section.

- 1. First, always turn off the equipment's power and release pressure in hoses and accumulators.
- 2. Place equipment and components in a safe or neutral position (use lockout tag).
- 3. Remove access panels and inspect hose and fittings for damage or leaks.
- 4. Repair or replace as needed.
- 5. Inspect other hydraulic components.
- 6. Reinstall the access panels.
- 7. Turn power back on.
- 8. Be aware of your equipment. Always look and listen for anything unusual.

A good place to begin is with a periodic inspection of hydraulic components. During normal operation, be aware of how the equipment sounds, looks and feels. Any noticeable difference in its daily operation may indicate a problem. Take time to check it out thoroughly.

### WHEN TO INSPECT AND HOW OFTEN

Because inspections vary by type of equipment, refer to your equipment operating manual for recommendations. Always use the manufacturer's inspection recommendations. If they are not available, a good rule of thumb is:

- For mobile equipment: Every 400–600 of operation hours or 3 months, whichever occurs first.
- For stationary equipment: Every 3 months.

The following factors influence how often you need to inspect your hose:

- Critical nature of equipment.
- Operating temperatures.
- Operating pressures.
- Environmental factors.
- Type of usage (rugged, abusive, shock, vibration, operating time, etc.).
- Accessibility of equipment.

Of course, personal experience with your equipment is often the best manual for knowing when to conduct inspections. If you're having a specific problem or problem area, it is important to keep a close eye on the situation.

Also, if you have a rugged, high-pressure hose application operating 24 hours a day, 7 days a week, it will require more frequent inspections than a hose used in a mild environment at ambient temperature that's only pressurized a few times daily.

Potential problem areas include high heat sources, rough abrasion areas, and tight bend or twisting. These possible trouble spots may need to be inspected and hoses replaced more often. Always look for opportunities to correct these potentially damaging situations.

### INSPECTION PROCEDURE

#### 1. Turn off equipment power and release pressure.

Remember to release pressure from the accumulators along with the system pressure. Lock the control box, and tag it with a warning sign that reads "DOWN FOR MAINTENANCE. DO NOT TURN ON POWER." If it's mobile equipment, turn the key off, put it in a safe place and/or disconnect the battery. Chock tires if necessary.

#### 2. Place equipment and components in a safe or neutral position.

Make sure components are not in mid-stroke, mid-cycle or holding a load. This could cause the equipment to be unstable or to move. Before working around the equipment, drop the load, retract cylinders, relieve pressure and allow cool-down time.

**3. Remove access panels and inspect hose and fittings for damage or leaks.**

Hose assemblies—what to look for:

**A. Cover**

The hose cover protects the reinforcement. If damaged, the reinforcement could be damaged as well. Visually inspect the cover for signs of abrasion, blisters, nicks, cracks or cuts, hardness, and color changes.

Look around to find what caused the damage. For instance, what's causing the abrasion? Is it rubbing against metal or another hose?

Check for hardness by pressing a ballpoint pen into rubber. Pen should not permanently indent or penetrate hose cover. Be careful—it could be hot! If the hose is hard, check to see if it's near a heat source such as an exhaust manifold.

**B. Leakage**

Leaking can occur in the hose at the coupling and/or the thread end. Signs of leakage include puddles of fluid in or around the equipment, low fluid in reservoir, and greasy/dirty hose. Release pressure and allow cool-down time. Then look around to locate the leak, but be very careful.

**C. Routing**

Proper routing is critical in preventing early hose failure. Make sure hoses do not rub against each other or against metal parts. Also, make sure they are not located next to a high heat source. Check for twisting or kinking, and make sure there's enough slack to allow for length changes under pressure. (See pages 53–58 for more details.)

**4. Repair or replace as needed.**

See pages 52–58 for hose assembly replacement.

**5. Inspect other hydraulic components.**

Look beyond the hose and fittings to other components, like valves, pumps, cylinders, etc., for leaks and damage.

**6. Reinstall the access panels.****7. Turn on the power.****8. Be aware of your equipment.**

Your eyes, ears and nose are your best inspection tools. Rely on your senses. If they tell you something isn't quite right, check it out to avoid the unwanted result of a hose assembly failure.

- Smell burning oil? It's a sign of excessive heat. Measure temperature; carefully inspect and test the hose assemblies.
- Is the hose's wire reinforcement showing? This is a sign of hose damage. Replace the hose assembly.
- Measure the temperature against Gates specifications. Also, carefully inspect and test the hose. For hose temperature recommendations, see page 29.

If any step in the inspection indicates a problem (or even a potential problem), have it checked out and repaired before operating. Keep a detailed log of inspection and service information. This can be used to identify problem areas and trends. For specific troubleshooting information, refer to pages 14–22.

**CAUTION:** Never check for leaks by running your hand over hose or hydraulic connections. Instead, use a piece of cardboard to locate a pressurized leak. For drips (low-pressure leaks), use a rag to clean the area and determine where the leak originates.

**CAUTION:** Never touch a pressurized hose assembly. Shut down the hydraulic system and relieve pressure before checking hose temperature.

**SLAM RISKS  
THE SMART WAY**

The Mine Safety and Health Administration (MSHA) recommends following the SLAM Risks program, intended for use as introductory material for risk assessment training across all industries.

**CONTRACTORS:**

**Stop** — Think through the task.

**Look** — Identify the hazards for each job step.

**Analyze** — Determine if you have the proper knowledge, training and tools.

**Manage** — Remove or control hazards and use proper equipment.

**OPERATORS:**

**Stop** — Isolate each step in a task and identify past and potential accidents, injuries and violations.

**Measure** — Evaluate the risks associated with the task and barriers that have allowed hazards to cause injuries.

**Act** — Implement controls to minimize or eliminate any hazards that make the risk unacceptable.

**Review** — Conduct frequent work site visits to observe practices and audit accidents, injuries and violations to identify root causes.

**Train** — Develop a human factor-based action plan and involve and train the miners.

## HOSE RISK MANAGEMENT



Risk management is a process for identifying, assessing and prioritizing various risks. Once the risks are identified, the risk manager will create a plan to minimize or eliminate the impact of negative events. A variety of strategies is available, depending on the type of risk and the type of business.

### COMPONENTS

- Risk Assessment Requirements
- Inspection of Hydraulic Hose Assemblies
- Maintenance Inspection Frequency
- Determination of Replacement Intervals
- Training Requirements
- Maintenance of Documentation

### RISK ASSESSMENT REQUIREMENTS

There is a systematic means of quantifying the relative level of danger for different types of machine hazards present to the machine operator and/or maintenance personnel.

- Hydraulic fluids under pressure escaping due to leaks or rupture of the hose assembly.
- Hydraulic fluids escaping due to dismantling of components under pressure.
- Falling or sudden movement of machine components in the event of hose assembly failure.
- Lashing and pulsation of the hose assembly in the event of pressure pulses.
- Risk of fire in the event of hydraulic fluids leaking.
- Risk of people slipping and falling on hydraulic fluid on the floor.

### INSPECTION OF HYDRAULIC HOSE ASSEMBLIES

Inspection of the hydraulic hose assemblies must be performed by a qualified person.

- After installation and before operation of the hose assembly.
- After accidents caused in the hydraulic system.
- After prolonged periods of non-use.
- After damage caused by collisions or other means.
- After repairs to the machine which could compromise safety.
- At specific regular intervals.
- Where deficiencies are identified during inspection which impair safety.
- Damaged or defective hose assemblies must be replaced before the machine is used again.

### MAINTENANCE INSPECTION FREQUENCY

- Nature and severity, application, past history, and manufacturer's recommendation.
- Periods for routine inspection must be determined prior to going into operation.
- The intervals are suitable to ensure that any deficiencies can be identified and remedied in good time.
- Identify periods of routine inspections based on previous experience.

**Group 1 equipment:** Inspection required every 3 months.

- Extended operating times, multiple shift operation or short machine/pressure pulse cycles.
- Strong external and internal (fluid) influence which greatly reduce the service life of the hose assembly.
- Handheld hydraulic tools, e.g., mobile shears.
- Extreme wear due to severe flexing, frequent load changes, high temperatures.

**Group 2 equipment:** Inspection required every 6 months.

- Normal loads with operating pressure significantly below normal pressure.
- Relatively straight hose routing without severe loads.
- Manageable consequential damage in the event of sudden failure of hydraulic hose assembly.

## DETERMINATION OF REPLACEMENT INTERVALS

**Group 1 equipment:** Replacement intervals not to exceed a 2-year period.

- Extended operating times, multiple shift operation or short machine/pressure pulse cycles.
- Strong external and internal (fluid) influence which greatly reduce the service life of the hose assembly.
- Handheld hydraulic tools, e.g., mobile shears.
- Extreme wear due to severe flexing, frequent load changes, high temperatures.

**Group 2 equipment:** Replacement intervals every 2 to 6 years (not to exceed a 6-year period).

- Normal loads with operating pressure significantly below normal pressure.
- Relatively straight hose routing without severe loads.
- Manageable consequential damage in the event of sudden failure of hydraulic hose assembly.

## TRAINING REQUIREMENTS

Training should be provided initially and biennially to all employees who work near or are exposed to hydraulic hose assemblies. The training should include:

- Hazards of hydraulic hose under pressure.
- Importance of reporting leaks.
- Abnormal operating conditions of machines that may be related.
- Damage and hose ruptures.

Qualified persons should receive training on the following:

- Review of location's hydraulic hose.
- Assembly procedure.
- Proper hose use and handling.
- Proper hose construction and assembly.

## MAINTENANCE OF DOCUMENTATION

Keep a traceable record of the process steps for the use of hydraulic hose assemblies and make this record available for inspection upon request. Include:

- Date of installation of the hydraulic hose assembly.
- Age and storage life of the hydraulic hose assemblies and hydraulic hoses.
- Inspection results/inspection periods.
- Risk assessment.



### EXPERT ADVICE



Retain records for at least 5 years beyond the replacement of the hydraulic hose assemblies.

## TROUBLESHOOTING



Abrasion



Crushed Hose



Cover Blisters

PROBLEM	SOLUTION
<p><b>ABRASION</b></p> <p>Part of the hose cover has been removed, exposing the hose reinforcement.</p> <p>This may be caused by continuous rubbing against equipment components, other hose or objects in the operating environment. Cover erosion may also be caused by non-compatible fluids such as toxic chemicals, acids, detergents and non-compatible hydraulic fluids. Exposed hose reinforcement is susceptible to rust and accelerated damage, leading to failure.</p>	<ol style="list-style-type: none"> <li><b>1. Reroute hose.</b> Bundle hoses together that flex in the same direction. Clamps, bent tube couplings, nylon ties, spring guards and sleeving can be used to keep hoses away from abrasion sources and exposure to non-compatible fluids.</li> <li><b>2. Protect hose.</b> Nylon and urethane sleeving and spring guards can be used to protect the cover from abrasion. (See pages 57-58 for more information.)</li> <li><b>3. Change to a hose with a cover that is compatible with any chemicals it may contact.</b></li> </ol> <p> <b>MEGASys™</b></p> <p>Gates offers abrasion-resistant hose covers with far greater abrasion resistance than any standard rubber hose in the industry. Gates MegaTuff™, XtraTuff™ Plus and XtraTuff hoses were developed to solve your abrasion problems.</p>
<p><b>CRUSHED HOSE</b></p> <p>Hose has been crushed.</p> <p>Flattened area has been caused by external forces (movement). Reinforcement is weakened and could burst. Also, the tube has collapsed restricting fluid flow.</p>	<p>Determine source of damage. Rerouting or guarding may be necessary. Replace hose.</p>
<p><b>COVER BLISTERS</b></p> <p>Blisters have formed on the hose cover.</p> <p>This can be caused by incompatible fluids that have permeated the hose tube and collected under the cover. Compressed gases can also permeate or effuse through the tube and become trapped under the cover. Trapped air in the hydraulic system can also cause blisters.</p>	<p>Replace the hose with one that is compatible with the fluid being used. If it is compressed gas, the cover can also be perforated (pinpricked) to allow the gas to pass through the cover. Textile hose covers also eliminate blistering. Bleed the system to eliminate any trapped air.</p> <p><b>CAUTION:</b> Some gases can displace breathable air and/or be flammable. Properly ventilate the routing area.</p>



Hose Burst at Coupling



Hose Cracks

PROBLEM		SOLUTION
<p><b>HOSE BURST AT COUPLING</b></p>	<p>Hose has burst at coupling end.</p> <p>This may be caused by insufficient hose slack, excessive bending/flexing or an over-crimped hose end. When a hose is pressurized, it typically shortens in length, putting excessive stress (tug) at the coupling. Excessive bending or flexing increases stress of the reinforcement.</p> <p>Over-crimping or use of the wrong ferrule will damage or crush the reinforcement, severely limiting its ability to withstand pressure.</p>	<p>Increase hose length to accommodate contraction under pressure. Increase actual bend radius as the hose exits the coupling. (See pages 52-57 for proper installation and routing.) Bend restrictors can also be used to reduce bending stress at the coupling. Replace hose assembly with properly crimped assembly.</p> <p> <b>MEGASys™</b></p> <p>Gates MegaSys hose products are designed to improve flexibility and perform at half the industry standard (SAE) minimum bend radius. This includes very high-pressure, spiral-reinforced wire braid and low-pressure suction hose.</p>
<p><b>HOSE CRACKS</b></p>	<p>Hose cover or tube has cracks and appears hardened.</p> <p>This is typically caused by exposure to excessive heat and/or ozone. Excessive heat can be created by:</p> <ul style="list-style-type: none"> <li>■ Routing near a heat source such as an exhaust manifold.</li> <li>■ Using an undersized hose or reservoir.</li> </ul> <p>An increase of 18°F above the maximum temperature may decrease hose life by half. Cracks can also be caused by flexing, especially at excessively low temperatures. Never exceed the temperature rating of the hose.</p>	<p>Select a hose that meets the temperature and flow requirements of the application. Also, identify the heat source and consider rerouting it away from the source to minimize the heat's effects. Examine reservoir size (if necessary). (See page 55 for more details). If the cracks were due to ozone exposure consider using Gates hose with XtraTuff Plus which has improved resistance to the harmful effects of ozone.</p>

## TROUBLESHOOTING



Weep at Hose/Coupling Interface



Hose Burst at Body



Mated Angle Seat Cracks

PROBLEM	SOLUTION
<p><b>WEEP AT HOSE/ COUPLING INTERFACE</b></p> <p>Fluid is seeping or weeping from the end of the ferrule.</p> <p>This may be caused by insufficient hose insertion during assembly and/or under-crimping/over-crimping. Also, excessive vibration, flexing and tugging may weaken the interface and reduce the assembly's ability to prevent fluid seepage.</p>	<p>Whether it has been under-crimped/over-crimped or the stem has been improperly inserted, the hose assembly must be replaced with one that has been properly assembled.</p> <p> <b>MEGASys™</b></p> <p>Gates revolutionary MegaCrimp and GlobalSpiral couplings have been designed to provide "weep-free" performance, as well as easy/simple insertion.</p>
<p><b>HOSE BURST AT BODY</b></p> <p>The hose has burst at some length away from the hose ends.</p> <p>This may be caused by excessive pressure surges, flexing, kinking, crushing or exceeding minimum bend radius.</p> <ul style="list-style-type: none"> <li>■ Pressure surges that exceed the hose's maximum operating pressure rating may result in reinforcement failure.</li> <li>■ Excessive flexing, kinking and crushing cause reinforcement fatigue and eventual failure, i.e., flexing a metal paper clip back and forth until it breaks.</li> <li>■ Bending the hose tighter than recommended will place excessive stress on the reinforcement, could open large gaps between strands of reinforcement, and will severely reduce the hose's ability to withstand pressure.</li> </ul>	<p>Review/inspect your operating pressure. It may be necessary to use a pressure transducer to measure the magnitude of any pressure surges. Select a hose that has the proper working pressure rating to handle the maximum pressure (including surges) of your application. If your application has frequent pressure surges, you may want to consider a spiral wire-reinforced hose rather than a wire braid-reinforced hose. (See pages 23-35 for proper hose selection.)</p> <p>Reroute hose to eliminate excessive flexing and/or exceeding the minimum recommended bend radius for the hose in use. Use a hose that has a smaller bend radius.</p>
<p><b>JIC/SAE SEAT CRACKS</b></p> <p>Fitting sealing cone seat is cracked.</p>	<p>If crack is due to over-torquing, use torque wrench and follow recommended torque specifications. If crack is due to excessive vibration or shock loading, change hose routing to reduce side load on fitting.</p>





Hose Twist

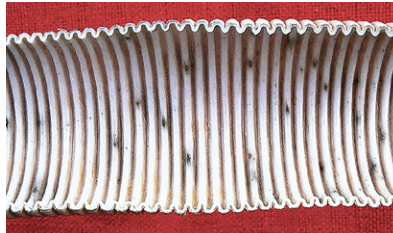

Static Discharge on PTFE Hose

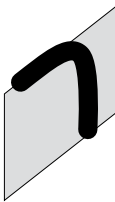
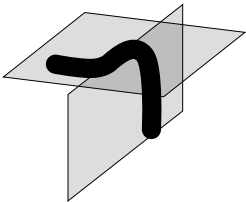
PROBLEM		SOLUTION
<p><b>HOSE TWIST</b></p>	<p>Hose assembly is twisted.</p> <p>This is evident by a spiraling hose label and bends in two planes, as demonstrated in the photograph above. Twisting misaligns the reinforcement and reduces its ability to withstand pressure. Twisting a high-pressure hose 7 degrees may reduce service life by as much as 90 percent.</p>	<p>Replace and reroute the hose to ensure that bending occurs only in one plane (see below). The use of bent tube or block-style couplings and adapters may improve routing. Also, when installing the assembly, hold the backup hex to prevent it from turning and applying a twist. If male and female couplings are used on the same hose assembly, install the male (non-swivel) end first.</p> <div style="display: flex; justify-content: space-around; align-items: center;"> <div style="text-align: center;"> <p style="color: green; font-weight: bold;">RIGHT</p>  <p>One-plane bend</p> </div> <div style="text-align: center;"> <p style="color: red; font-weight: bold;">WRONG</p>  <p>Two-plane bend</p> </div> </div> <p>Twist can also cause the coupling to twist in service, causing leaks or coupling blowoff.</p>
<p><b>STATIC DISCHARGE ON PTFE HOSE</b></p>	<p>Pinholes in PTFE tube allow fluid to escape through the cover.</p> <p>Dissection of tube shows black "burn" areas and pinholes. This is caused by a release of an electrostatic charge through the tube to the wire cover. Some fluids have the potential for electrostatic buildup.</p>	<p>Replace damaged hose with one that has a conductive tube (Gates C14 conductive tube). This allows any charge to be conducted to the end fittings rather than discharging through the tube wall.</p>

## TROUBLESHOOTING



Leak/Weep at Coupling Interface



Hose Tube Failure

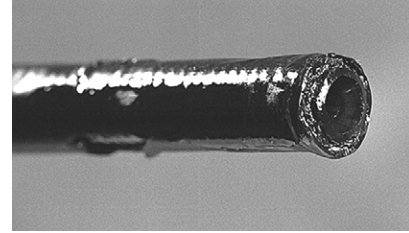

Tube Swell

PROBLEM		SOLUTION
<p><b>LEAK/WEEP AT COUPLING INTERFACE</b></p>	<p>Coupling leaks at thread or seat.</p> <p>This may be caused by any of the following:</p> <ul style="list-style-type: none"> <li>■ Missing or damaged O-ring.</li> <li>■ Damaged threads or seat angle.</li> <li>■ Thread misalignment.</li> <li>■ Incompatible thread ends or seat angles.</li> <li>■ Over- or under-torquing.</li> </ul>	<p>Remove the connection and inspect.</p> <ol style="list-style-type: none"> <li>1. Certain couplings require the use of an O-ring. If it is missing, replace it. If an O-ring is used, check for damage caused by installation or possible material breakdown from heat or fluid incompatibility. Alternative O-ring materials may be required. Replace if necessary.</li> <li>2. Check the threads and/or seat angles for damage that may have occurred prior to or during installation. Any ding or burr may be a potential leak path. Replace if necessary.</li> <li>3. If the coupling was misaligned during installation, threads may have been damaged. Replace and carefully reinstall.</li> <li>4. It is possible to thread together some components that are not compatible. Use Gates thread ID kit to assist in identifying mating components. Some thread end configurations have better sealability than others. (See pages 36-44 for proper coupling selection.)</li> <li>5. Over-torquing of a threaded connection can stretch and damage threads and mating seat angles. Overtorquing can also damage the staking area of the nut. Over-torquing can cause cracking of either the nut or seat. Under-torquing does not allow proper sealing. (See pages 57-58 for recommended installation torque.) Use of a torque wrench can alleviate such problems.</li> </ol> <p> <b>MEGASys™</b></p> <p>Gates Full Torque Nut technology featured on MegaCrimp and GlobalSpiral couplings resists the harmful effect of cracked nuts due to being over-torqued.</p>
<p><b>HOSE TUBE FAILURE</b></p>	<p>Tube material is cracked and brittle. High temperature is caused by excessive fluid velocity.</p>	<p>Compare pump output to the hose size using nomographic chart (see page 25). Select a hose type with a higher temperature rating. If not possible, add cooling devices and increase reservoir size.</p>



Over-crimp



Under-crimp

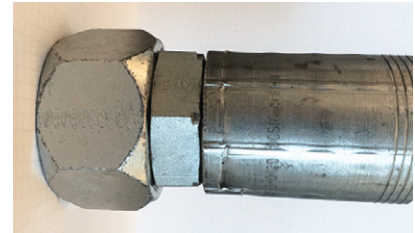

Double Crimp

PROBLEM		SOLUTION
<b>TUBE SWELL</b>	<p>The equipment has become sluggish and unresponsive.</p> <p>Cutting and evaluating the hose shows the hose tube is swollen and deteriorated and possibly washed out in sections. Fluid incompatibility is the likely cause. Many new fluids are now promoted as “environmentally friendly” but may not necessarily be compatible with the hose.</p> <p>See chemical resistance tables in Gates hydraulic catalog (industrial #35093/automotive #431-2080).</p> <p>Excess fluid temperatures can also cause the tube to bulge near the end of the coupling.</p>	<p>Replace the hose using a tube material recommended for that particular fluid. (See pages 23-35 for proper hose selection.)</p> <p> <b>MEGASys™</b></p> <p>Gates EnviroFluid™ hoses are compatible with biodegradable hydraulic fluids like polyglycol and vegetable oil, as well as standard petroleum-based fluids.</p>
<b>OVER-CRIMP</b>	<p>The ferrule appears to be over-crimped which could lead to leaking or premature failure.</p>	<p>Refer to the crimp manuals or charts for proper die selection and crimp settings. Receive hands-on training for fabricating hydraulic assemblies. Use Gates calipers to measure the finished crimp diameter for accuracy. Crimp outside diameter (O.D.) tolerance is +/- .010 (in). (See pages 21 &amp; 48 to properly measure crimp diameter.)</p>
<b>UNDER-CRIMP</b>	<p>The ferrule appears to be under-crimped which can lead to coupling leaks or blowoffs.</p>	<p>Refer to the crimp manuals or charts for proper die selection and crimp settings. Receive hands-on training for fabricating hydraulic assemblies. Use Gates calipers to measure the finished crimp diameter for accuracy. Crimp O.D. tolerance is +/- .010 (in). (See pages 21 &amp; 48 to properly measure crimp diameter.)</p>
<b>DOUBLE CRIMP</b>	<p>The coupling has been crimped two or more times.</p> <p>This can weaken the stem (causing stem collapse) and affect the integrity of the hose/coupling interface.</p>	<p>When crimping, ensure that you have the correct crimp setting and that the coupling is crimped along the entire length of the ferrule, or follow manufacturer’s crimp assembly procedures.</p>

## TROUBLESHOOTING



Coupling Corrosion



Coupling Blowoff

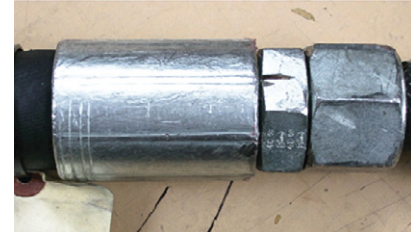

Reuse of Hydraulic Hose

PROBLEM		SOLUTION
<p><b>COUPLING CORROSION</b></p>	<p>Coupling has been exposed to corrosive conditions that have begun to cause rust and deterioration.</p> <p>Chemicals, fertilizers, humidity or a marine environment could be the cause of the corrosion.</p> <p>Many hydraulic fittings are manufactured from carbon steel and have zinc dichromate plating that provides minimal corrosion resistance. SAE J516 requires manufacturers to pass a 144-hour continuous salt-spray test.</p>	<p>Provide adequate protection for the coupling or minimize exposure to corrosive elements. Other coupling materials, such as stainless steel and brass, are available and can provide better resistance to some corrosive elements.</p> <p> <b>MEGASys™</b></p> <p>Gates TuffCoat™ Xtreme™ plating offers 840 hours of protection against corrosion. This is nearly a 6X improvement over the 144-hour SAE and even greater improvement to the typical 96-hour OE industry standards.</p>
<p><b>COUPLING BLOWOFF</b></p>	<p>The crimped coupling comes off the end of the hose.</p> <p>This may be caused by any of the following:</p> <ol style="list-style-type: none"> <li>1. Under- or over-crimping.</li> <li>2. Incorrect crimping dies.</li> <li>3. Improper skive (if applicable).</li> <li>4. Incorrect fitting/hose combination.</li> <li>5. Ferrule not engaged into the stem locking collar (if using two-piece coupling).</li> <li>6. Coupling not fully inserted into hose.</li> </ol> <p>Insufficient hose slack in routing will cause the hose to pull away from and release the coupling. Mixing various manufacturers' hose and couplings may also reduce coupling retention.</p>	<p>Examine and replace the hose assembly to ensure proper assembly procedures are followed (see pages 45-51 for details). Modify hose length and/or routing to accommodate potential hose length reduction under pressure (see page 55). Never mix different manufacturers' hose, couplings or crimpers.</p>
<p><b>REUSE OF HYDRAULIC HOSE</b></p>	<p>The ferrule has been cut off and reassembled using the existing hose and coupling with a new ferrule.</p> <p>The crimping of the existing stem will cause stem collapse and affect the hose/coupling interface, and, ultimately, the life of the hose.</p>	<p>Never cut off and use the existing hose with the existing or new coupling. This will cause premature failure. Always replace a hose assembly with new hose and coupling.</p>



Mushroom-Flare Crimp



Tail-Flare Crimp

PROBLEM		SOLUTION
<b>MUSHROOM-FLARE CRIMP</b>	<p>The crimp of the ferrule is not full length, leaving a mushroom flare at the top of the ferrule.</p> <p>This could lead to coupling blowoff or early failure.</p>	<p>With the Gates crimping system, be sure that the ferrule or shell is fully engaged with the dies to ensure a full-length crimp. Refer to Gates crimp manuals and charts for proper crimping instructions. Receive proper training on crimping procedures with the Gates hose and coupling system.</p>
<b>TAIL-FLARE CRIMP</b>	<p>The crimp of the ferrule is not full length, leaving a tail flare at the end of the ferrule.</p>	<p>With the Gates crimping system, be sure that the ferrule or shell is fully engaged with the dies to ensure a full-length crimp. Refer to Gates crimp manuals and charts for proper crimping instructions. Receive proper training on crimping procedures with the Gates hose and coupling system.</p>

### GOOD CRIMP

Examples of good crimps:

#### MegaCrimp Coupling

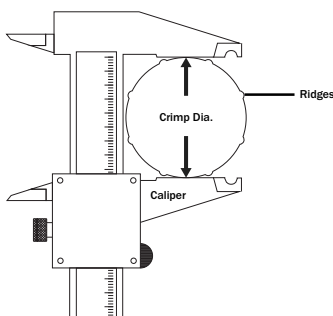

Measuring -8 and larger couplings

#### GlobalSpiral Coupling

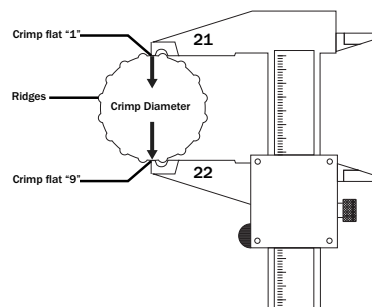
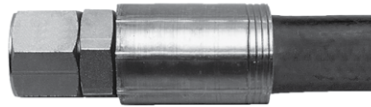

Measuring -4 and -6 couplings

#### EXPERT ADVICE



A visual inspection does not confirm a good crimp. Always check the crimp O.D. to verify the crimp is within specification even if you are using a crimper such as the GC32TSi with crimp OD measuring capability.

# TROUBLESHOOTING

## UNRESPONSIVE EQUIPMENT

**PROBLEM:** Equipment has become sluggish or unresponsive. There are a number of potential causes that should be reviewed:

CAUSE	SOLUTION
<b>AIR IN THE HYDRAULIC SYSTEM</b>	<ul style="list-style-type: none"> <li>■ Check fluid level.</li> <li>■ Purge (bleed) air out of system.</li> <li>■ Check connections on suction line (pump intake).</li> </ul>
<b>PRESSURE DROP</b>	<ul style="list-style-type: none"> <li>■ Review hose sizes and lengths to minimize pressure drop. Smaller hose diameters and longer lengths increase the pressure drop in a line.</li> <li>■ Replace block-style couplings and adapters with bent tube style to improve laminar flow and reduce pressure drop.</li> </ul>
<b>HOSE TUBE COLLAPSE OR SWELL</b>	<ul style="list-style-type: none"> <li>■ Check fluid compatibility with tube material.</li> <li>■ Vacuum may have exceeded hose vacuum rating. Select a hose that meets the requirements.</li> </ul>
<b>NON-FUNCTIONING HYDRAULIC COMPONENTS (PUMPS, VALVES, ETC.)</b>	<ul style="list-style-type: none"> <li>■ Check each hydraulic component for full function, i.e., seal may have rolled in a cylinder causing it to bind and limit stroke.</li> </ul>
<b>BLOCKAGE IN FLUID FLOW</b>	<ul style="list-style-type: none"> <li>■ Check flow in each line and component for blockage. It may be necessary to remove and replace each component to determine where blockage exists. Eliminate source of contamination.</li> <li>■ Check and replace filter if necessary.</li> </ul>
	<p>If you encounter a problem that hasn't been covered in this manual or which still exists after your troubleshooting efforts have been exhausted, contact your Gates distributor or sales representative.</p>



## HOSE SELECTION

### WHY USE HOSE?

There are two common types of fluid connection—rigid tubing and hose assemblies.

Rigid tubing offers the following advantages:

- Better heat dissipation.
- Tighter bend radius.
- Lighter weight.
- Ability to handle pressures exceeding 6,000 psi.

Hose assemblies, however, have the following advantages:

- Less susceptible to damage from vibration or movement.
- No brazing or specialized bending required.
- Easier to obtain in the aftermarket.
- Easier to route around obstacles.
- Sound absorption.
- Dampens pressure surges.

Today's hydraulic hose is much lighter and provides improved bend radius compared to earlier products. With the introduction of these hoses (such as Gates MegaSys products), the weight advantage of bent tubing has been minimized, while the bend advantage has been reduced by half.

Given the availability and routing advantages of hose, maintenance personnel often prefer it over metal tubing. It is not uncommon to replace a hard-to-reach failed bent tube with a hose assembly.

### HOSE CONSTRUCTION

A hose is generally made up of three components:

#### 1. Tube

The tube's function is to contain the material conveyed. Refer to the chemical resistance charts and characteristics of hose stock types in Gates hydraulic catalog to identify material for a specific fluid.

#### 2. Reinforcement

The reinforcement is the hose's muscle. It provides the necessary strength to resist internal pressure (or external pressure in the case of suction/vacuum). The three basic types of reinforcement are:

- Braided
- Spiraled
- Helical coil

#### 3. Cover

The cover protects the reinforcement and tube from environmental conditions such as:

- Weather
- Ozone
- Abrasion
- Temperature
- Chemicals

Refer to the chemical resistance charts and characteristics of hose stock types in Gates hydraulic catalog to help identify cover material.

Braided reinforcement can be wire or textile and can have single or multiple layers.



Spiraled reinforcement on hydraulic hose is typically wire or textile and has four or six layers (plies). Spiral-reinforced hose can typically handle more severe applications with longer impulse service life.



Helical coil reinforcement keeps the hose from collapsing during suction (vacuum) and tight bending.



## HOSE SELECTION

### HOSE PERFORMANCE CHARACTERISTICS

Hydraulic hose (and hose assemblies) has a limited life dependent on service conditions to which it is applied. Subjecting hose (and hose assemblies) to conditions more severe than the recommended limits significantly reduces service life. Exposure to combinations of recommended limits (i.e., continuous use at maximum rated working pressure, maximum recommended operating temperature and minimum bend radius) will also reduce service life. Failure to follow proper selection, installation and maintenance procedures may result in injury to personnel and/or damage to equipment.

Hose assemblies in service should be regularly inspected for leaks, abrasion, kinks, cover blisters or other such damage. Assemblies showing signs of wear or damage should be replaced immediately. Maximum service life can be attained by complying with the following recommendations:

#### EXPERT ADVICE



#### WARNING:

- Hoses are not designed to pull external loads or to replace ropes, cables, etc.
- Do not recouple used hose with either field attachable or permanent fittings.
- Heed these warning messages to avoid serious injury from premature hose failures or hose being blown out of fittings.
- Do not use Hose Length Extenders to mend a blown assembly.

**Working Pressure** — The hydraulic system pressure should not exceed the rated working pressure of the hose. Pressure surges or peaks exceeding the rated working pressure are destructive and must be taken into account when selecting a hose. It is not safe to use hose assemblies above their rated working pressure.

**Minimum Burst Pressure** — Burst pressures are reference pressures intended for destructive testing purposes and design safety factors only.

**Temperature Range** — Do not expose hose to internal or external temperatures exceeding the recommended limits. Consult additional technical data when hydraulic fluids contain emulsions or solutions. The fluid manufacturer's recommended maximum operating temperature for any given fluid must not be exceeded, regardless of hose temperature range (reference the Gates hydraulic catalog for temperature ranges). Some fluids reduce the safe operating temperature of a hose (i.e., water in a hydraulic hose).

**Fluid Compatibility** — The hydraulic assembly (tube, cover, reinforcement and couplings) must be fluid-compatible. The correct hose must be used because phosphate ester and petroleum-based hydraulic fluids have drastically different chemical characteristics. Many hoses are compatible with one or the other but not all fluids. Gates G2XH and C5D hoses are capable of handling both phosphate ester and petroleum-based hydraulic fluids.

**Minimum Bend Radius** — Do not bend or flex hose to a radius smaller than the minimum recommended and do not subject hose to tension or torque. This can place excessive stress on the reinforcement and severely reduce the ability of the hose to withstand pressure.

**Hose Size** — The hose size (inside diameter) must be capable of handling the required flow volume. Too small an I.D. for a given volume of flow results in excessive fluid turbulence, pressure drop, heat generation and tube damage. It is generally a best practice not to exceed 30 feet per second fluid velocity in a hydraulic system. Using a larger inner diameter (I.D.) hose will lower fluid velocity.

**Hose Routing** — Restrain, protect or guide hose (clamps can be used) to minimize risk of damage due to excessive flexing, whipping, or contacting other moving parts or corrosives. Determine hose lengths and configurations that will result in proper routing and protection from abrasion, snagging or kinking, and provide leak-resistant connections.

**Hose Length** — Correct hose length determinations include considerations for length changes under pressure, machine vibration and motion, and hose assembly routing.

**Hose Application** — Select the proper hose for the application. Vacuum service which can be addressed with Gates Multi Master GMV MegaFlex and special fluid or high-temperature capabilities are among the applications requiring particular consideration and a specific hose. Do not use Gates hydraulic hose in place of permanent piping. When additional information is required, contact your local Gates representative.





### NOMOGRAPHIC CHART

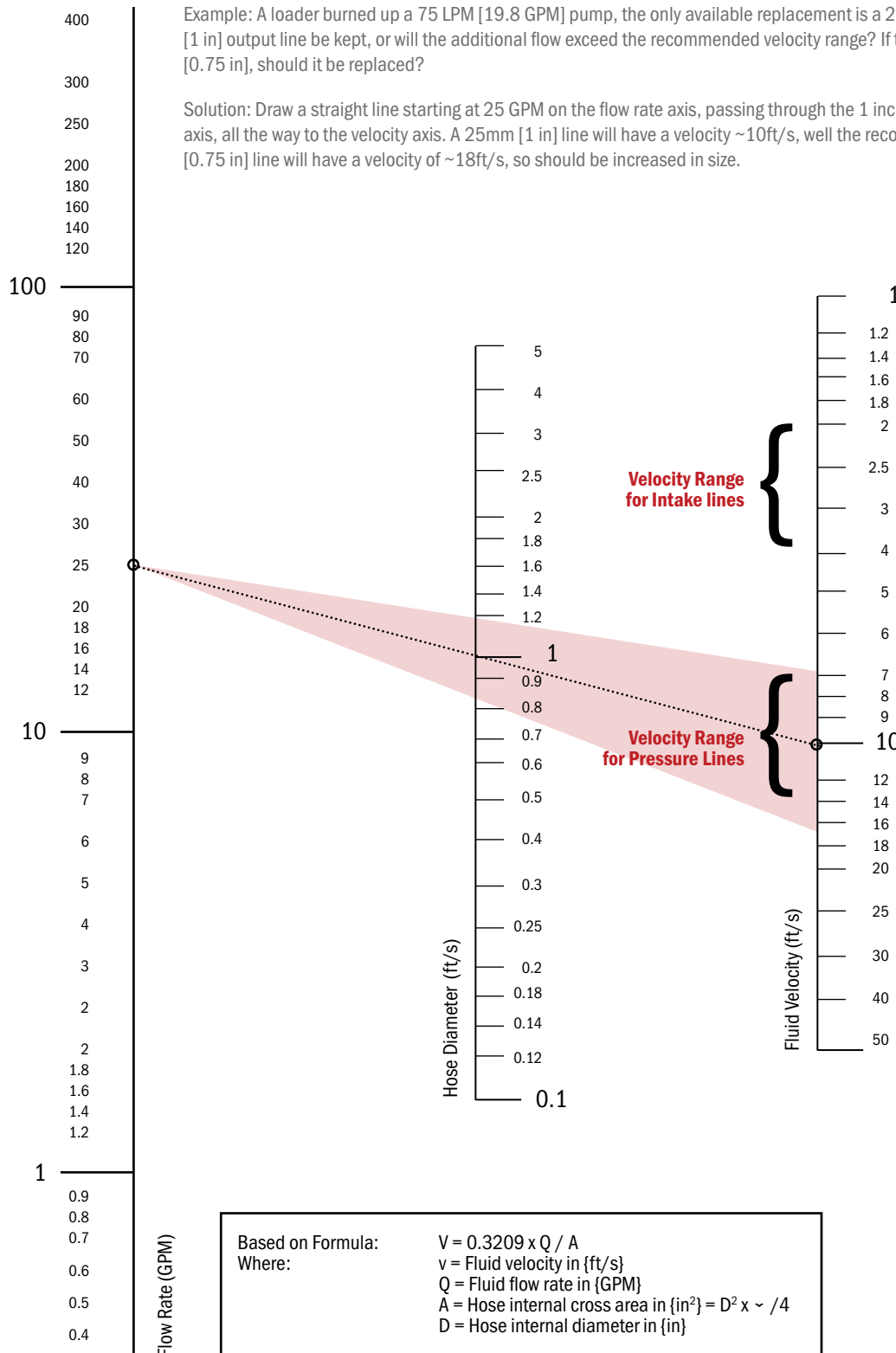

## HOSE SELECTION

To take into account the hose performance characteristics and service application, a simple and easy method is used to properly select a hydraulic hose. An effective way to remember this hose selection criteria is to remember the word "STAMPED."

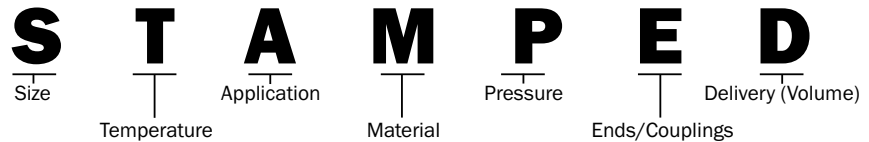

<p><b>S</b></p> <p><b>HOSE SIZE (DASH NUMBERS)</b></p>	<p>The inside diameter of the hose must be adequate to keep pressure loss to a minimum and avoid damage to the hose due to heat generation by excessive turbulence. See hose sizing nomographic chart on previous page.</p> <p>The nomographic chart will help you select the correct hose size for a given hydraulic system. The velocity of the hydraulic fluid should not exceed the range shown in the right-hand column. When fluid velocities are higher than recommended in the chart, the results are turbulent conditions with loss of pressure and excessive heating. Higher velocities may be used if the flow of hydraulic fluid is intermittent or for short periods of time only.</p> <p>Velocity of hydraulic fluid in suction lines should always fall within the range recommended to ensure efficient pump operation.</p> <p>To determine the replacement hose size, read the layline printing on the side of the original hose. If the original hose layline is painted over or worn off, the original hose must be cut and inside diameter measured for size. NOTE: Before cutting an original hose assembly, measure the overall assembly length and coupling orientation. This measurement will be required to build the replacement assembly or match the hose I.D. to the port size. Hose O.D. should not be used to identify the I.D. of the hose. Different hose constructions will vary with the wall thickness and O.D.</p> <p>The hydraulics industry has adopted a measuring system called Dash Numbers to indicate hose and coupling size. The number which precedes the hose or coupling description is the dash size (see table below). This industry standard number denotes hose I.D. in sixteenths of an inch (the exceptions are the SAE 100R5, SAE 100R14 and refrigerant hoses, where dash sizes denote hose I.D. compared to equivalent tube O.D.). Hose O.D. can be a critical factor when hose routing clamps are used or hose is routed through bulkheads. Check individual hose specification tables for O.D.s.</p>
<p><b>T</b></p> <p><b>TEMPERATURE</b></p>	<p>When selecting a replacement assembly, two areas of temperature must be considered. These are fluid temperature and ambient temperature. The hose selected must be capable of withstanding the minimum and maximum temperature of the system. Care must be taken when routing hose near hot manifolds, and in extreme cases, a heat shield may be advisable.</p> <p>Actual service life at temperatures approaching the recommended limit will depend on the particular application and the fluid being used in the hose. Intermittent (up to 10 percent of operating time) refers to momentary temperature surges. Detrimental effects increase with increased exposure to elevated temperatures.</p>
<p><b>A</b></p> <p><b>APPLICATION</b></p>	<p>Determine where or how the replacement hose or assembly is to be used. Most often, only a duplicate of the original hose will have to be made, provided the original hose assembly gave acceptable service life. To fulfill the requirements of the application, additional questions may need to be answered: Where will hose be used? Equipment type? Working and surge pressures? Suction application? Fluid and/or ambient temperature? Fluid compatibility? Environmental conditions? Routing requirements? Government and industry standards being met? Unusual mechanical loads? Hose construction? Thread end connection type? Permanent or field attachable couplings? Thread type? Minimum bend radius? Non-conductive hose required? Excessive abrasion? Expected service life?</p>

<p style="text-align: center;"><b>M</b></p> <p style="text-align: center;"><b>MATERIAL TO BE CONVEYED</b></p>	<p>Some applications require specialized oils or chemicals to be conveyed through the system. Hose selection must ensure compatibility of the hose tube, cover, couplings and O-rings with the fluid used. Additional caution must be exercised in hose selection for gaseous applications where permeation can occur.</p> <p>Permeation, or effusion, is seepage through the hose resulting in loss of fluid. This may occur when hose is used with fluids such as (but not limited to): liquid and gas fuels, refrigerants, helium, fuel oil, and natural gas. Consider whether there are potential hazardous effects of permeation through the hose, such as explosions, fires and toxicity. Refer to applicable standards for specific applications such as fuels and refrigerants.</p> <p>If gas permeates through the tube, consider pin-perforated covers to prevent gas buildup under the cover. Also consider the compatibility of the system fluid not only with the tube, but also with the braid, cover, fittings and other components, since permeation may expose the entire hose assembly to the system fluid. (For more information on hydraulic fluids, please see page 33.)</p> <p><b>NOTE:</b> Some couplings contain nitrile O-rings, which must be compatible with the fluids being used. See the chemical resistance tables in Gates hydraulic catalog.</p>
<p style="text-align: center;"><b>P</b></p> <p style="text-align: center;"><b>PRESSURE</b></p>	<p>In the hose selection process, it's essential to know the system pressure, including pressure spikes. Published working pressures must be equal to or greater than the system pressure. Pressure spikes greater than the published working pressure will shorten hose life and must be taken into consideration. Gates DOES NOT recommend using hose on applications having pressure spikes greater than published working pressures of the hose.</p> <p>Burst pressures are reference pressures intended for destructive testing purposes and design safety factors only. Typically, for dynamic hydraulic applications, the minimum burst pressure rating is four times that of the maximum working pressure rating.</p> <p>Pressure Drop</p> <p>What is pressure drop? As related to fluid power, pressure drop is the difference between the pressure of a fluid as it enters one end of a hydraulic hose assembly and the pressure of that fluid as it leaves the other end. There will be a difference in pressure, and it will be less. How much less depends on what is between the beginning and end of the hose assembly. Here are some factors that can influence the amount of pressure drop:</p> <ol style="list-style-type: none"> <li>1. <b>Friction</b> – This is the rubbing of fluid against the inside walls of the hose assembly.</li> <li>2. <b>Type of fluid</b> – Different fluids behave differently under pressure. Thicker fluids are moved with greater difficulty and will exhibit greater pressure drop.</li> <li>3. <b>Temperature of fluid</b> – Warming fluids thin them so they are moved more easily, as with automotive oil.</li> <li>4. <b>Length of hose assembly</b> – The longer it is, the more surface there is for friction to decrease pressure.</li> <li>5. <b>Size (I.D.) of hose</b> – This affects the fluid velocity for a given flow rate. Higher velocities result in greater pressure drop. Therefore, a larger I.D. hose will produce less pressure drop.</li> <li>6. <b>Type of couplings and adapters</b> – Any change in bore or change in direction (such as with 45° or 90° elbows) can increase the amount of pressure drop.</li> <li>7. <b>Flow rate</b> – Pressure drop increases with flow rate for the same size hose.</li> </ol>

**CONTINUED ON NEXT PAGE**

## HOSE SELECTION

### HOSE SELECTION (CONTINUED)

#### WHO CARES ABOUT PRESSURE DROP?

Suppose you need 4,000 psi of output from a hose assembly for hydraulic equipment to run efficiently. There will be some pressure drop, and you must allow for it in helping to plumb the system with hose, couplings and adapters. This means that the input pressure to the hose assembly must be equal to the output, plus the amount of pressure drop. If the pressure drop in this example is 150 psi, then you will need 4,150 psi of input.

Output PSI = Input PSI - Pressure Drop

4,000 PSI = 4,150 PSI - 150 PSI

#### HOW CAN YOU DETERMINE THE AMOUNT OF PRESSURE DROP?

That's the easy part. Contact your local Gates representative who is trained and equipped to quickly solve pressure drop problems for you. Your representative will need the following information:

- Type of application.
- Fluid type and viscosity (at desired temperature).
- Fluid temperature (°F).
- Fluid flow rate (GPM).
- Hose size and length.
- Number and type of fittings.

To do your own pressure drop analysis, please visit [www.gates.com/fluidflowcalculator](http://www.gates.com/fluidflowcalculator).

# E

## ENDS OR COUPLINGS

Identify the end connectors using the information provided starting on page 35. There are two functional parts of a hose coupling: 1) the hose barb end; 2) the port connecting end. Both must be identified to determine the correct coupling to use. Once the thread ends have been identified, consult the appropriate section of the catalog for specific part number selection.

# D

## DELIVERY (VOLUME)

How much fluid must go through the hose? This will determine the size of hose that must be used. Undersizing a hose leads to increased pressure loss, turbulent flow and heat buildup. Oversizing the hose adds unnecessary cost, weight and bulk.

## HOSE NOMENCLATURE

### M 3 K

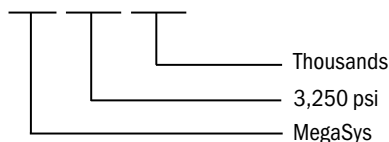

AC – Air conditioning  
 CP – Coal power  
 EFG - Environmentally Friendly  
 Fluid Gates Spiral  
 G – Gates proprietary  
 GTH – Global textile braid, high-temp  
 H – High-temp  
 HMP – High-temp, multi-fluid  
 J – Jack hose  
 K – Thousands  
 L – Low-temp  
 LO – Lock-on

LW – Longwall  
 M – MegaSys  
 MT – MegaTech™  
 MV – MegaVac™  
 NC – Non-conductive  
 RL – Return line  
 SHR – Slim hose rotary  
 TH7 – Gates thermoplastic 100R7  
 TH8 – Gates thermoplastic 100R8  
 XH – Xtreme heat, high-temp 300°F



**MAXIMUM TEMPERATURE LIMITS FOR WATER, WATER/OIL EMULSIONS AND WATER/GLYCOL SOLUTIONS**

HOSE	PRESSURE LINES	RETURN LINES
G8K, EFG6K, EFG5K, EFG4K, EFG3K, MXG4K, MXT, G2L, CPB, G1, M2T™, M6K, M5K, M4K, M3K, RFS, RLA, C5C, C5E, CPS, LOC, LOL	+200°F (+93°C)	+180°F (+82°C)
M4KH, M3KH, G2H, G1H, MegaTech Line, G2XH, C5D, G3H, GTH, GMV MegaFlex, GMV, RLC, TR500	+225°F (+107°C)	+180°F (+82°C)

**EXPERT ADVICE**



- Water, water/oil emulsions and water/glycol solutions must be kept below the temperatures listed in the adjacent table, relative to line pressures. Low-pressure applications (i.e., in return lines) require lower maximum temperatures as shown.
- To avoid equipment breakdown and possible injury, the fluid manufacturer's recommended maximum operating temperature for any given fluid must not be exceeded. If different than the listed hose temperatures, the lower limit must take precedence.
- Operating at maximum temperature and maximum working pressure at the same time may cause reduced service life.

**DASH NUMBERS**

HOSE I.D. (INCHES)				
DASH NUMBER	ALL EXCEPT C5 SERIES, C14 AND REFRIGERANT		C5 SERIES, C14 AND REFRIGERANT	
	INCHES	MILLIMETERS	INCHES	MILLIMETERS
-3	3/16	4.8	–	–
-4	1/4	6.4	3/16	4.8
-5	5/16	7.9	1/4	6.4
-6	3/8	9.5	5/16	7.9
-8	1/2	12.7	13/32	10.3
-10	5/8	15.9	1/2	12.7
-12	3/4	19.0	5/8	15.9
-14	7/8	22.2	–	–
-16	1	25.4	7/8	22.2
-20	1-1/4	31.8	1-1/8	28.6
-24	1-1/2	38.1	1-3/8	34.9
-32	2	50.8	1-13/16	46.0
-40	2-1/2	63.5	2-3/8	60.3
-48	3	76.2	–	–
-56	3-1/2	88.9	–	–
-64	4	101.6	–	–

## HOSE SELECTION

### CHARACTERISTICS OF HOSE STOCK TYPES

The characteristics shown below are for the normal or usual range of these specific stocks. Stocks can be changed somewhat through different compounding to meet the needs of specialized applications. Tube and cover stocks may occasionally be upgraded to take advantage of improved materials and technology. (For detailed information on a specific hose tube or cover stock, check the chemical resistance table in the Gates hydraulic catalog.)

CHEMICAL NAME	POLY-CHLOROPRENE	NITRILE	NYLON	CSM	EPDM	CPE	PTFE
<b>FLAME RESISTANCE</b>	Very Good	Very Good	Good	Good	Poor	Good	Good
<b>PETROLEUM BASE OILS</b>	Good	Excellent	Good to Excellent	Good	Poor	Very Good	Excellent
<b>DIESEL FUEL</b>	Fair to Good	Good to Excellent	Good to Excellent	Good	Poor	Good	Excellent
<b>RESISTANCE TO GAS PERMEATION</b>	Good	Good	Good to Excellent	Good to Excellent	Fair to Good	Good	Good to Excellent
<b>WEATHER</b>	Good to Excellent	Poor	Excellent	Very Good	Excellent	Good	Excellent
<b>OZONE</b>	Good to Excellent	Poor (for Tube) Good (for Cover)	Excellent	Very Good	Outstanding	Good	Excellent
<b>HEAT</b>	Good	Good	Good	Very Good	Excellent	Excellent	Excellent
<b>LOW TEMPERATURE</b>	Fair to Good	Poor to Fair	Excellent	Poor	Good to Excellent	Good	Excellent
<b>WATER/OIL EMULSIONS</b>	Excellent	Excellent	Good to Excellent	Good	Poor	Excellent	Excellent
<b>DIESTERS</b>	Poor	Poor	Excellent	Fair	Excellent	Very Good	Excellent
<b>PHOSPHATE ESTERS</b>	Fair (for Cover)	Poor	Excellent	Fair	Very Good	Very Good	Excellent
<b>PHOSPHATE ESTER BASE EMULSIONS</b>	Fair (for Cover)	Poor	Excellent	Fair	Very Good	Very Good	Excellent



## AGENCY SPECIFICATIONS

### Agency Specifications and Hose Selection Manual

It is important to understand the agency specification requirements that may be applicable to your application. Below is a list with a brief description of each.

<b>SAE*</b>	The Society of Automotive Engineers establishes the American standards for most hydraulic hose. SAE guidelines provide general properties of size, tolerances and minimum performance characteristics of each major hose type. SAE is made up of representatives from the major manufacturers. SAE does not test or certify hose and fitting performance. SAE rated hoses from different manufacturers are similar but not exactly the same. SAE J517 identifies the 100R hose series, which SAE ranges from 100R1 to 100R19. The number designation following the "R" does not identify the number of reinforcement layers, but rather the specific requirements of a type of hose. (See SAE J517 hose specification chart, page 34.)
<b>DNV</b>	Det Norske Veritas for North Sea Floating Vessels certifies hose for use on floating vessels.
<b>DIN</b>	The Deutsche Industrial Norme are German standards that are accepted through much of Europe. Similar to SAE, they identify general guidelines for size, tolerances, construction and minimum performance characteristics of major hose types.
<b>EN</b>	By 1997, all hydraulic DIN standards were superseded by European standards called EN (European Norm). The new European Norm for spiral hydraulic hoses is now called EN 856 and is again divided into subcategories, 4SP and 4SH, which are identical to the old DIN 4SP and 4SH. The new European standards are also included as subdivisions of SAE standards R12 and R13. The new European Norm for hydraulic hoses with steel braid wire reinforcement that does not require cover removal (non-skiving) is EN 853. The standard EN 853 is divided into two parts: 1SN for single braid and 2SN for two braids.
<b>NCB 174</b>	The National Coal Board is now governed by British Coal Corporation. It sets the dynamic and static pressures for the coal industry.
<b>IJS</b>	The Industrial Jack Specification specifies the tests and procedures for hydraulic hose and hose jacking systems. The test uses a limited impulse test life to determine a static (non-impulse) working pressure rating.
<b>MSHA</b>	The Mine Safety and Health Administration specifies flame-resistance properties required of hose covers used in underground mining applications. It's also the recognized standard for flame resistance for many other industries.
<b>DOT/FMVSS</b>	The Department of Transportation/Federal Motor Vehicle Safety Standards describe the requirements for hydraulic, air and vacuum brake hose, hose assemblies, and fittings for use on passenger vehicles, trucks, buses, trailers and motorcycles.
<b>USCG</b>	The United States Coast Guard requirements are met through two SAE specifications for hose and fittings that are used on marine vessels. They are SAE J1475 and J1942. Also, J1942/1 lists hose that is accepted (but not approved) by the USCG.
<b>MIL/DOD</b>	The United States Military/Department of Defense has many specifications that identify dimensional and performance requirements for various hose types. Some specifications require a manufacturer to be listed as an approved source. Many specifications require a low-temperature rating to -65°F.
<b>ISO</b>	International Standards Organization. The ISO 18752 standard was released in 2006 to define wire or textile reinforced hoses and assemblies for hydraulic applications. ISO 18752 first defines hydraulic hoses by a constant working pressure class for all sizes. Then hoses are classified by four different grades of performance and two different designs. Based on the number of impulse cycles they can resist at a defined temperature, hoses are divided into four different grades: A, B, C, or D. Based on the outside diameter dimension, there are two different hose design designations: S = Standard dimension and C = Compact dimension. The hose type is described by combining the grade and then the design designation. For example, BC designates a "B" performance grade in a "C" compact hose design style.

\* SAE documents are available through SAE Customer Service at 877-606-7323 and [www.sae.org/about/contact](http://www.sae.org/about/contact).

# HOSE SELECTION GUIDE

STANDARD INDUSTRY SPECIFICATION	GATES DESCRIPTION	CONSTRUCTION (REINFORCEMENT)	USE	STOCK	
				TUBE NAME	COVER NAME
Gates Proprietary Design	G8K	6-spiral, wire	Ultra High Pressure & Impulse Cycle Life, High Temperature, Petroleum Oils	Polychloroprene	Polychloroprene
ISO 3862 R15 SAE 100R15	EFG6K	4 & 6-spiral, wire	Extremely High Pressure & Impulse Cycle Life, High Temperature, Petroleum Oils, Environmental Fluids	Nitrile	Polychloroprene
EN 856 4SP/4SH	EFG6K-MTF	4 & 6-spiral, wire	Extremely High Abrasion Resistant, Pressure & Impulse Cycle Life, High Temperature, Petroleum Oils, Environmental Fluids	Nitrile	MegaTuff
ISO 18752 Grade D	EFG5K	4 & 6-spiral, wire	Extremely High Pressure & Impulse Cycle Life, High Temperature, Petroleum Oils, Environmental Fluids	Nitrile	Polychloroprene
ISO 3862 R13 SAE 100R13	EFG5K-MTF	4 & 6-spiral, wire	Extremely High Abrasion Resistant, Pressure & Impulse Cycle Life, High Temperature, Petroleum Oils, Environmental Fluids	Nitrile	MegaTuff
EN 856 4SH/4SP EN 856 R13	MXG5K-XTP	Patented Xpiral wire	High Abrasion and Ozone Resistant, Extremely High Pressure & Impulse Cycle Life, High Temperature, Petroleum Oils, Environmental Fluids	Nitrile	XtraTuff Plus
ISO 18752 SAE J517 100R13	ID5K	4-spiral, wire	Extremely High-Pressure, High-Impulse Applications	HNBR	Polychloroprene
	EFG4K	4-spiral, wire	Very High Pressure & Impulse Cycle Life, High Temperature, Petroleum Oils, Environmental Fluids	Nitrile	Polychloroprene
ISO 18752 Grade D ISO 3862 R12 SAE 100R12	EFG4K-MTF	4-spiral, wire	Extremely High Abrasion Resistant, Very High Pressure & Impulse Cycle Life, High Temperature, Petroleum Oils, Environmental Fluids	Nitrile	MegaTuff
EN 856 R12	EFG4K-XTF	4-spiral, wire	High Abrasion Resistant, Pressure & Impulse Cycle Life, High Temperature, Petroleum Oils, Environmental Fluids	Nitrile	XtraTuff Nitrile
	MXG4K-XTP	Patented Xpiral wire	High Abrasion and Ozone Resistant, Pressure & Impulse Cycle Life, High Temperature, Petroleum Oils, Environmental Fluids	Nitrile	XtraTuff Plus
ISO 18752 Grade D ISO 3862 R12 SAE 100R12	EFG3K	4-spiral, wire	Very High Pressure & Impulse Cycle Life, High Temperature, Petroleum Oils, Environmental Fluids	Nitrile	Polychloroprene
EN 856 4SP EN 856 R12	EFG3K-MTF	4-spiral, wire	Extremely High Abrasion Resistant, Very High Pressure & Impulse Cycle Life, High Temperature, Petroleum Oils, Environmental Fluids	Nitrile	MegaTuff
Gates Proprietary Design	M6K	2-braid, wire	High Pressure, Impulse Cycle Life & Flexibility, Tight Bend Radius, Petroleum Oils, Environmental Fluids	Nitrile	Nitrile + PVC
	M5K	2-braid, wire	High Pressure, Impulse Cycle Life & Flexibility, Tight Bend Radius, Petroleum Oils, Environmental Fluids	Nitrile	Nitrile + PVC and Polychloroprene
Gates Proprietary Design ISO 18752 Grade B	M5K-MTF	2-braid, wire	Extremely High Abrasion Resistant, High Pressure, Impulse Cycle Life & Flexibility, Tight Bend Radius, Petroleum Oils, Environmental Fluids	Nitrile	MegaTuff
	M5K-XTF	2-braid, wire	High Abrasion Resistant, Pressure, Impulse Cycle Life & Flexibility, Tight Bend Radius, Petroleum Oils, Environmental Fluids	Nitrile	XtraTuff Nitrile
	M4K	2-braid, wire	High Pressure, Impulse Cycle Life & Flexibility, Tight Bend Radius, Petroleum Oils, Environmental Fluids	Nitrile	Nitrile + PVC
ISO 18752 Grade B ISO 11237 R19 SAE 100R19	M4K-MTF	2-braid, wire	Extremely High Abrasion Resistant, High Pressure, Impulse Cycle Life & Flexibility, Tight Bend Radius, Petroleum Oils, Environmental Fluids	Nitrile	MegaTuff
	M4K-XTF	2-braid, wire	High Abrasion Resistant, Pressure, Impulse Cycle Life & Flexibility, Tight Bend Radius, Petroleum Oils, Environmental Fluids	Nitrile	XtraTuff Nitrile
ISO 18752 Grade C ISO 11237 R19 SAE 100R19	M4KH	2-braid, wire	High Temperature, Pressure, Impulse Cycle Life & Flexibility, Tight Bend Radius, Petroleum Oils, Environmental Fluids	Nitrile	Polychloroprene
	M4KH-MTF	2-braid, wire	Extremely High Abrasion Resistant, High Temperature, Pressure, Impulse Cycle Life & Flexibility, Tight Bend Radius, Petroleum Oils, Environmental Fluids	Nitrile	MegaTuff
	M3K	1 & 2-braid, wire	High Pressure, Impulse Cycle Life & Flexibility, Tight Bend Radius, Petroleum Oils, Environmental Fluids	Nitrile	Nitrile + PVC
ISO 18752 Grade B ISO 11237 R17 SAE 100R17	M3K-MTF	1 & 2-braid, wire	Extremely High Abrasion Resistant, High Pressure, Impulse Cycle Life & Flexibility, Tight Bend Radius, Petroleum Oils, Environmental Fluids	Nitrile	MegaTuff
EN 857 1SC	M3K-XTF	1 & 2-braid, wire	High Abrasion Resistant, Pressure, Impulse Cycle Life & Flexibility, Tight Bend Radius, Petroleum Oils, Environmental Fluids	Nitrile	XtraTuff Nitrile
ISO 18752 Grade C ISO 11237 R17 SAE 100R17	M3KH	1 & 2-braid, wire	High Temperature, Pressure, Impulse Cycle Life & Flexibility, Tight Bend Radius, Petroleum Oils, Environmental Fluids	Nitrile	Polychloroprene
EN 857 1SC	M3KH-MTF	1 & 2-braid, wire	Extremely High Abrasion Resistant, High Temperature, Pressure, Impulse Cycle Life & Flexibility, Tight Bend Radius, Petroleum Oils, Environmental Fluids	Nitrile	MegaTuff
SAE 100R16 SAE 100R2	MXT	High-tensile steel wire braid	High Pressure, Impulse Cycle Life & Flexibility, Tight Bend Radius, Petroleum Oils, Environmental Fluids	Nitrile	Nitrile + PVC
Performance	MXT-XTP	High-tensile steel wire braid	High Abrasion and Ozone Resistant, High Pressure, Impulse Cycle Life & Flexibility, Tight Bend Radius, Petroleum Oils, Environmental Fluids	Nitrile	XtraTuff Plus
ISO 11237 2SC R16 ISO 1436 2SN R2 EN 857 2SC	M2T	2-braid, wire	High Pressure, Impulse Cycle Life & Flexibility, Tight Bend Radius, Petroleum Oils, Environmental Fluids	Nitrile	Nitrile + PVC
EN 853 2SN SAE 100R16 SAE 100R2	M2T-MTF	2-braid, wire	Ultra High Abrasion Resistant, High Pressure, Impulse Cycle Life & Flexibility, Tight Bend Radius, Petroleum Oils, Environmental Fluids	Nitrile	MegaTuff
	M2T-XTF	2-braid, wire	High Abrasion Resistant, Pressure, Impulse Cycle Life & Flexibility, Tight Bend Radius, Petroleum Oils, Environmental Fluids	Nitrile	XtraTuff Nitrile
Exceeds ISO/DIS 1436 SAE 100R16 EN 857 2SC	CM2TDL-XTF	2-braid, wire	High Pressure, Impulse Cycle Life & Flexibility, Tight Bend Radius, Petroleum Oils, Environmental Fluids	Nitrile	XtraTuff Nitrile
ISO 1436 2SN R2 SAE 100R2 Type AT EN 853 2SN	G2L	2-braid, wire	High Pressure, Low Temperature, Petroleum Oils & Environmental Fluids	Nitrile	Polychloroprene
	G2XH	2-braid, wire	Extremely High Heat, High Pressure, Petroleum Oils & Environmental Fluids	CPE	CSM
ISO 1436 2SN R2 SAE 100R2 Type AT EN 853 2SN	G2H	2-braid, wire	High Pressure, Temperature, Petroleum Oils & Environmental Fluids	Nitrile	CSM
	G2H-MTF	2-braid, wire	High Pressure, Temperature, Petroleum Oils & Environmental Fluids	Nitrile	MegaTuff
Gates Proprietary Design	M-XP	2-braid, wire	High Pressure & Impulse Cycle Life, High Flexibility, Tight Bend Radius, Petroleum Oils, Environmental Fluids	Nitrile	Nitrile + PVC and Polychloroprene
IJ100	J2AT	2-braid, wire	Industrial Jack Hose Applications	Nitrile	Nitrile + PVC
IJ100	J2AT-MTF	2-braid, wire	Ultra High Abrasive Industrial Jack Hose Applications	Nitrile	MegaTuff
ISO 1436 1SN R1 SAE 100R1 Type AT EN 853 1SN	G1	1-braid, wire	Medium Pressure, Petroleum Oils & Environmental Fluids	Nitrile	Nitrile + PVC





STANDARD INDUSTRY SPECIFICATION	GATES DESCRIPTION	CONSTRUCTION (REINFORCEMENT)	USE	STOCK	
				TUBE NAME	COVER NAME
SAE 100R1 Type AT	G1H	1-braid, wire	High Temperature, Medium Pressure, Petroleum Oils & Environmental Fluids	Nitrile	CSM
Gates Proprietary Design SAE 100R1	RFS	1-braid, wire	Low Pressure, Powder Fire Suppressant Applications	Nitrile	Nitrile + PVC
SAE 100R3	G3H	2-braid, textile	Petroleum Oils, Antifreeze, Water, High Temperature	Nitrile	Polychloroprene
SAE 100R6	GTH	1-braid, textile	Petroleum Oils, Antifreeze, Water, High Temperature	Nitrile	Polychloroprene
SAE 100R6	GTHX	1-spiral, textile	Petroleum Oils, Antifreeze, Water, High Temperature	Nitrile	Polychloroprene
Gates Proprietary Design	M500	1-braid, wire, textile	Pilot Lines, Grease Lines and Pressure Return Lines, 500 psi or Less Pressure Applications	Nitrile	Nitrile + PVC
SAE 100R4	Multi Master	High tensile textile, helical wire	Return & Suction High Temperature	Nitrile	Polychloroprene
SAE 100R4	GMV	2-spiral, textile, helical wire	Return & Suction High Temperature	Nitrile	Polychloroprene
SAE 100R4	G4H	2-spiral, textile, helical wire	Return & Suction High Temperature	Nitrile	Polychloroprene
SAE 30R2 Type 1 & 2, B20 Biodiesel	RLA	1-braid, textile	Return & Suction Low Pressure, Biodiesel up to 125°F	Nitrile	Nitrile + PVC
Gates Proprietary Design	RLC	3-braid, textile	Return & Low Pressure	Nitrile	Nitrile + PVC
Gates Proprietary Design	MegaTech LOC	1-braid, textile	Extremely High Heat, Hot Oil Pressure & Return Lines, High Temperature Rotary Oil/Air, Air Compressor, Petroleum Oils, Transmission Oil Cooler	CPE	Textile
SAE 30R2, 30R6, 30R7 and B20 Biodiesel	LOC	1-braid, textile	Petroleum, Oils, Antifreeze, Water, Air & Biodiesel up to 125°F	Nitrile	Textile
Gates Proprietary Design	LOL	1-braid, textile	Petroleum Oils, Antifreeze, Water & Air	Nitrile	Nitrile + PVC and Polychloroprene (LOLA)
SAE J1402, DOT** FMVSS 106-74	TR500	1-braid wire, textile	Petroleum & Synthetic Fluids, Air Brakes	Nitrile	Textile
Gates Proprietary Design	MegaTech G5TB	2-braid, wire, textile	Extremely High Heat, Hot Oil Pressure & Return Lines, High Temperature Rotary Oil/Air, Air Compressor, Petroleum Oils	CPE	Textile
SAE 100R2 Type AT SAE 100R2 Type AT	MegaTech II	2-braid, wire, textile	Extremely High Heat, Hot Oil Pressure & Return Lines, High Temperature Rotary Oil/Air, Air Compressor, Petroleum Oils	CPE	Textile
Gates Proprietary Design	MegaTech 3000	2-braid, wire, textile	Pressurized Hot Oil Return Lines and Rotary Oil Lines	CPE	Textile
SAE J1402 DOT FMVSS 106-74	MegaTech 1000	1-braid, wire, textile	Extremely High Heat, Hot Oil Pressure & Return Lines, High Temperature Rotary Oil/Air, Air Compressor, Petroleum Oils, Air Brake	CPE	Textile
Gates Proprietary Design	MegaTech 500	1-braid, wire, textile	Extremely High Heat, Hot Oil Pressure & Return Lines, High Temperature Rotary Oil/Air, Air Compressor, Petroleum Oils	CPE	Textile
Gates Proprietary Design	MegaTech 250	1-braid, wire, textile	Extremely High Heat, Hot Oil Pressure & Return Lines, High Temperature Rotary Oil/Air, Air Compressor, Petroleum Oils, Transmission Oil Cooler	CPE	Textile
SAE 100R5, SAE J1402 DOT FMVSS 106-74 Type All	*C5C	3-braid, T-W-T	Petroleum Oil, Air Brake, Power Steering	Nitrile	Textile
SAE 100R5, SAE J1402 DOT FMVSS 106-74 Type All	C5C-XH	1-braid, wire, textile	Extremely High-Temperature Petroleum-Based or Phosphate Ester Fluids	CPE	Textile
SAE J1402, DOT FMVSS 106-74 Type All	C5D	3-braid, T-W-T	Petroleum & Synthetic Fluids, Air Brakes	CPE	Textile
SAE J1527, SAE J1942 ISO 840-A1	C5M	1-braid, textile	Marine Fuel & Oil	Nitrile	Nitrile + PVC
SAE J1402, DOT FMVSS 106-74 Type A1	C5E	3-braid, T-W-T	Air Brake, Power Steering, Lube	Nitrile	Textile
<b>PTFE</b>					
SAE 100R14	C14	1-braid, stainless steel	High Temperature, Multi Fluid, Non-Conductive	PTFE	Stainless Steel
SAE 100R14	C14CT	1-braid, stainless steel	High Temperature, Multi Fluid, Conductive	PTFE	Stainless Steel
<b>THERMOPLASTIC</b>					
SAE 100R7	TH7	1-braid, polyester	Petroleum & Synthetic Fluids	Nylon	Urethane
SAE 100R7	TH7NC	1-braid, polyester	Non-Conductive	Nylon	Urethane
SAE 100R7	TH7DL	1-braid, polyester	Petroleum & Synthetic Fluids, Dual Line	Nylon	Urethane
SAE 100R7	TH7NCDL	1-braid, polyester	Non-Conductive, Dual Line	Nylon	Urethane
SAE 100R7	TH7S	Synthetic fiber	Petroleum & Synthetic Fluids	Polyester	Urethane
SAE 100R7	TH7SNC	Synthetic fiber	Non-Conductive	Polyester	Urethane
SAE 100R8	TH8	2-braid, polyester	Petroleum & Synthetic Fluids	Nylon	Urethane
SAE 100R8	TH8NC	2-braid, polyester	Non-Conductive	Nylon	Urethane
SAE 100R18	TH18	1-braid, synthetic fiber	Petroleum & Synthetic Fluids	Nylon	Urethane
SAE 100R18	TH18NC	2-braid, synthetic fiber	Non-Conductive	Nylon	Urethane
<b>REFRIGERANT</b>					
SAE J51 Type A2 Dimensions/Type D Performance, SAE J2064 and J3062 Type C, Class II Performance	PolarSeal™ AC134a	Nylon barrier, 2-spiral, polyester	Air Conditioning (R12 and R134a)	Polychloroprene	EPDM
SAE J2064, SAE J3062 Type C, Class 1	PolarSeal ACC-PSII	Single-braid polyester	Reduced Barrier Construction, Air Conditioning (R12, R13A and R22)	Elastomeric	Elastomeric

\* -4 and -5 sizes have a Polychloroprene tube, \*\*MegaTech1000 sizes -4, 6, -8, -10



## SAE J517 HYDRAULIC HOSE SPECIFICATIONS

This SAE standard provides general, dimensional and performance specifications for the most common hoses used in hydraulic systems on mobile and stationary equipment (100R series).

SAE 100R SERIES	DESCRIPTION	EQUIVALENT GATES HOSE
<b>100R1</b>	Steel Wire Reinforced, Rubber Covered Hydraulic Hose (1 wire braid)	
	Type AT - Thin Cover (no-skive type)	G1, G1H
<b>100R2</b>	High Pressure, Steel Wire Reinforced, Rubber Covered Hydraulic Hose (2 wire)	
	Type A- Thick Cover (skive type)	
	Type AT - Thin Cover (no-skive type)	G2H, G2, M2T, MXT**
<b>100R3</b>	Double Fiber Braid (Non-Metallic), Rubber Covered Hydraulic Hose	C3, C3H
<b>100R4</b>	Wire Inserted Hydraulic Suction Hose	MultiMaster GMV, GMV
<b>100R5</b>	Single Wire Braid, Textile Covered Hydraulic Hose	C5 series hoses (CXH, C, D, E)
<b>100R6</b>	Single Fiber Braid (Non-Metallic), Rubber Covered Hydraulic Hose	GTH
<b>100R7</b>	Thermoplastic Hydraulic Hose	
	Black	TH7
	Orange - Non-Conductive	TH7NC
<b>100R8</b>	High Pressure, Thermoplastic Hydraulic Hose	
	Black	TH8S
	Orange - Non-Conductive	TH8NC
<b>100R9</b>	High Pressure, Four Spiral Steel Wire Reinforced, Rubber Covered Hydraulic Hose	
	Type A - Thick Cover (skive type)	
	Type AT - Thin Cover (no-skive type)	
<b>100R10</b>	Heavy-Duty, Four Spiral Steel Wire Reinforced, Rubber Covered Hydraulic Hose	Discontinued by SAE
	Type A - Thick Cover (skive type)	
	Type AT - Thin Cover (no-skive type)	
<b>100R11</b>	Heavy-Duty, Six Spiral Steel Wire Reinforced, Rubber Covered Hydraulic Hose	
<b>100R12</b>	Heavy-Duty, High Impulse, Four Spiral Wire Reinforced, Rubber Covered Hydraulic Hose	MXG4K*, EFG4K, EFG4K
<b>100R13</b>	Heavy-Duty, High Impulse, Multiple Spiral Wire Reinforced, Rubber Covered Hydraulic Hose	EFG5K, MXG5K***
<b>100R14</b>	PTFE Lined Hydraulic Hose	
	Type A	C14
	Type B	C14CT
<b>100R15</b>	Heavy-Duty, High Impulse, Multiple Spiral Wire Reinforced, Rubber Covered Hydraulic Hose	EFG6K
<b>100R16</b>	Compact, 21 MPa, Maximum Operating Pressure, 1 & 2 Steel Wire Reinforced, with Smaller Bend Radius	MXT, M2T
<b>100R17</b>	Compact, High Pressure, 1 & 2 Steel Wire Reinforced, Rubber Covered Hydraulic Hose	M3K
<b>100R18</b>	21 MPa Thermoplastic Hydraulic Hose	TH18
<b>100R19</b>	Compact, 28 MPa Maximum Working Pressure, 1 and 2 Steel Wire Reinforced, Rubber Covered Hydraulic Hose	MXG4K, M4K

\*MXG4K Exceeds performance of SAE100R12 with a patented Xspiral construction.

\*\*MXT Exceeds the performance of SAE100R2.

\*\*\*MXG5K Exceeds performance of SAE100R13 with patented Xspiral construction.

## HYDRAULIC FLUIDS

### TYPES

Most hydraulic fluids are petroleum-based. Others are either water-glycol or synthetic-based (i.e., phosphate ester). All provide specific properties that may or may not meet the needs of a given application.

In the past, hydraulic fluids have caused problems by leaking into the ground and contaminating the water supply and surrounding area. Today, the industry is moving toward more “environmentally friendly” fluids where advances have led to many new generations of “green” fluids.

Green fluids are typically synthetic- or vegetable-based. Synthetic fluids are primarily ester-based. Vegetable oils are gaining popularity since they cost less than synthetic and are more biodegradable. They also have excellent lubricity and a high viscosity index. However, they have a limited temperature range with rapid oxidation at elevated temperatures. Although the fluid base may be biodegradable and non-toxic, the additives may not be.

### VOCABULARY OF FLUIDS

The properties that fluid suppliers are striving to improve are:

- 1. Lubricity** – The fluid must keep friction low and maintain an adequate film between moving parts to prevent wear of pumps, bearings, vanes, gears, pistons and rods. Increasing pressures and, consequently, closer tolerances make lubricity even more important.

**CONTINUED ON NEXT PAGE**



## HOSE SELECTION

### VOCABULARY OF FLUIDS (CONTINUED)

#### VOCABULARY OF FLUIDS

2. Viscosity — It is the fluid “thickness” or resistance to flow. Pump manufacturers specify this according to clearances, speeds, temperatures and suction characteristics. The fluid must be thin enough to flow freely, yet heavy enough to prevent wear and leakage. Viscosity might not be so critical in selecting a hydraulic fluid except that it varies with temperature. Fluid thickens when it cools, thins as it heats up. Because some hydraulic systems must work under wide temperature extremes, viscosity range is important.
3. Viscosity index — This measures the rate of viscosity change with temperature: The higher the index, the more stable the viscosity as temperature varies.
4. Rust resistance — Moisture gets into petroleum fluids by condensation and by contamination of the reservoir. Rust inhibitors and preventives combat the effects of moisture. Obviously, they are very important in water-in-oil emulsions and water-glycol fluids.
5. Oxidation resistance — Air, heat and contamination all promote fluid oxidation which forms sludges and acids. Oxidation inhibitors delay the process.
6. Foaming resistance — Although control of foaming depends largely on reservoir design, anti-foaming additives in the fluid help, too.

#### COMPATIBILITY

Refer to Material in STAMPED in this section (page 27.)

#### HANDLING AND DISPOSAL OF FLUIDS

Please contact local agencies for proper storage and disposal regulations.

### STORAGE AND SHELF LIFE CONSIDERATIONS

Storage environment, along with rubber materials, can vary the shelf life limit. Some hose materials last longer in storage due to inherent resistance characteristics. Other materials require additives during compounding. These additives are eventually consumed by varying environments, even in seemingly ideal storage conditions.

Shelf life is difficult to predict because many variables affect the hose. Proper storage precautions can result in 4+ years of shelf life. Beyond this time, service life can decrease significantly, depending on storage environment variables. Some of these variables include temperature, humidity, ozone, oil, solvents, corrosive materials, fumes, insects, rodents, radioactivity, space allowance and bends.

Hose should be stored in a cool, dry area never exceeding 100°F. If stored below freezing, prewarming may be required prior to handling, testing and placing into service. Store hose in original container.

Never stack hose too high, as its weight can crush hose at the bottom of the stack. Direct sunlight, rain, heaters or close proximity to electrical equipment may reduce hose life.

Gates recommends hose in extended storage be visually inspected and tested prior to use. Hose judged marginal should be replaced to avoid potential failure, property damage or bodily injury. Store hose on a first-in, first-out basis. Unusually long or poor storage environment can deteriorate hose, reduce performance and may lead to premature failure.

### SAE J1273 (OCT 2019) - SECTION 9.1 AGE CONTROL

Shelf life is the period of time when you should expect the hose to retain full capabilities for the intended service life. Unless otherwise specified:

- \* For bulk hoses without fittings attached, maximum of 4 years.
- \* For assembled hoses, maximum of 2 years.

These two periods are consecutive for a total storage time of 6 years (4 years in bulk and 2 years assembled). You may purchase this SAE guideline for the most up to date revision and details since the printing of this document.

### SERVICE LIFE CONSIDERATIONS

Hydraulic hose has a limited life dependent on service conditions to which it is applied. Subjecting hose (and hose assemblies) to conditions more severe than the recommended limits significantly reduces service life. Exposure to combinations of recommended limits (i.e., continuous use at maximum rated working pressure, maximum recommended operating temperature and minimum bend radius) will also reduce service life. Failure to follow proper selection, installation and maintenance procedures may result in injury to personnel and/or damage to equipment.

Hose assemblies in service should be regularly inspected for damage. Assemblies showing signs of wear or damage should be replaced immediately. Maximum service life can be attained by complying with the recommendations outlined in this manual.

## COUPLING SELECTION

### IDENTIFICATION TOOLS

Tools to assist you in identifying thread ends include coupling templates, thread identification kits, measuring tools and calipers.



#### ECRIMP APP

Gates eCrimp mobile app, available for iPhone and Android, allows users to identify unknown couplings and adapters through a series of simple questions. The app can be downloaded for free on iOS and Android using these QR codes.

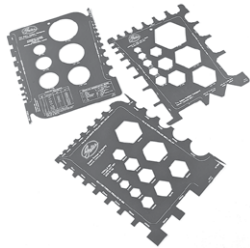

#### HYDRAULIC COUPLING TEMPLATES

ADVERTISING NUMBER: 39549

These templates provide a fast and easy way to measure North American thread and flange ends, seat angles (37° and 45°), and hose I.D.



#### INTERNATIONAL THREAD IDENTIFICATION KIT

PART NUMBER: 70264

PRODUCT NUMBER: 7369-0015

Attractive carrying case suitable for counter display and field sales calls. Contains male and female metric and British gauge for identifying thread size. Also includes pocket thread I.D. kit.



#### NORTH AMERICAN THREAD IDENTIFICATION KIT

PART NUMBER: 70270

PRODUCT NUMBER: 7369-0016

Attractive carrying case suitable for counter display and field sales calls. Contains 45 anodized gauges, male and female, for identifying pipe and UN/UNF 2A/2B threads. Also includes pocket thread ID kit.



#### DIGITAL CALIPER

PRODUCT NUMBER: 7369-0322

Gates specially designed digital caliper is perfect for making those precise measurements required for hydraulic coupling crimps. Use the color-coded buttons to switch from inches to metric, turn the caliper on and off, and reset the measurements to zero—at any position. The easy-to-read LCD screen clearly displays the crimp diameter digitally, taking the guesswork out of manual readings. Constructed of hardened stainless steel, the digital caliper comes with a handy protective carrying case.

### COUPLING IDENTIFICATION

A hydraulic coupling stem consists of two functional ends:

1. The hose end for hose attachment.

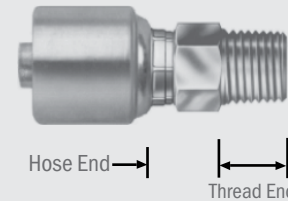

2. The thread end for port attachment.

The hose end is identified by the hose size and type to which it is attached. Serration patterns are specified by the hose manufacturer to meet hose performance.

The thread end of a coupling (or adapter) can be identified by comparing it with the coupling being replaced or by measuring the port or thread end to which it will be attached. The thread end may also come in different configurations.

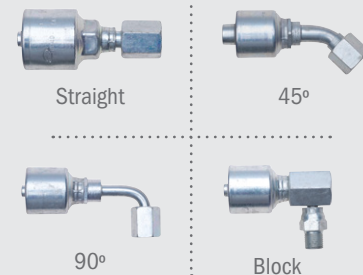

Hose ends and thread ends are measured by industry standard dash sizes. The hose end dash size refers to the inside diameter in 1/16" (except for SAE 100R5, PolarSeal and SAE 100R14, which are based on tube O.D. and are one size smaller than the dash size implies, i.e., 8C5C hose is actually 13/32" I.D.).

**CONTINUED ON NEXT PAGE**

# COUPLING SELECTION

## COUPLING IDENTIFICATION (CONTINUED)

There are two types of hydraulic couplings—permanent and field attachable.

### Permanent Couplings

Permanent couplings require crimping or swaging equipment to assemble to a hose. They are available in either preassembled or two-piece configurations.

Preassembled couplings are made with the ferrule permanently attached to the stem. Two-piece couplings consist of a stem and separate ferrule. When using two-piece couplings, it is important to match the ferrule with its appropriate stem and hose.

### Field Attachable Couplings

There are different types of field attachable fittings—skive, no-skive, mandrel type, lock-on, C5 and those that are stamped for Dept. of Transportation (DOT) use.

### EXPERT ADVICE



**DO NOT** use couplings with any Gates hydraulic hose unless recommended by Gates in writing. Never mix couplings and hoses from different manufacturers. Never rerimp or recouple used hose with permanent or field attachable couplings. Never reuse field attachable couplings which previously have been placed in service.

## MEASURING THREADS AND SEAT ANGLES

### MEASURING THREADS

With the caliper, measure the thread diameter at the largest point (O.D. of male threads; I.D. of female threads).

Using the pitch gauge, determine the number of threads per inch. Comparison of gauge and coupling threads against a lighted background will ensure an accurate reading.

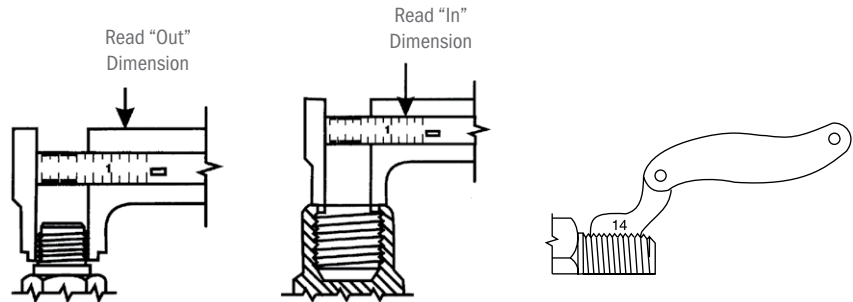

### MEASURING SEAT ANGLES

When the centerline of the seat gauge points straight out of the coupling, the angles of the gauge and seat match.

Compare the measurements taken to the coupling specification tables that appear in Gates Hydraulic Hose, Couplings & Equipment Catalog 35093 or the specifications in the Gates Hydraulic Coupling International Thread Identification Manual 35095-H.

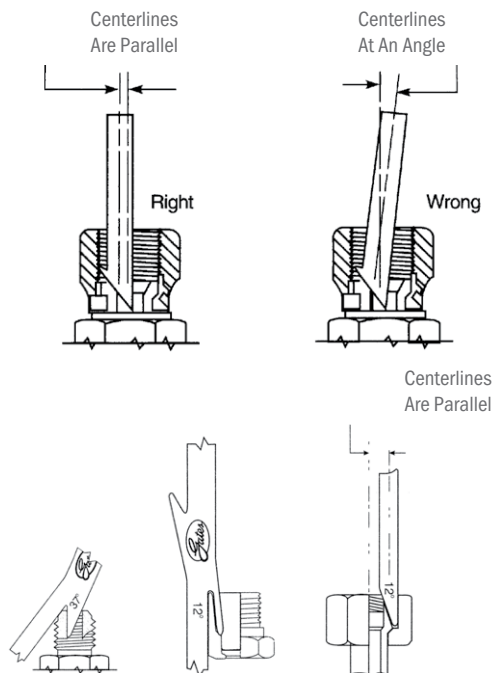

**NOTE:** Thread binding will occur when different thread configurations are used. **DO NOT** mix thread configurations.

## NORTH AMERICAN STANDARDS

There are nine common North American hydraulic thread types—national pipe thread, JIC 37° flare, SAE 45° flare, SAE straight thread O-ring boss, O-ring face seal, flareless tube, SAE inverted flare, SAE Code 61 and Code 62 flanges, and staple type.

While all these couplings are widely used in the U.S. and Canada, they are also found on a worldwide basis in a variety of applications.

### NATIONAL PIPE THREAD

These threads are available in several varieties—National Pipe Tapered for Fuels (NPTF), National Pipe Straight for Fuels (NPSF) and National Pipe Straight for Mechanical Joints (NPSM). The NPTF male coupling will mate with the NPTF, NPSF or NPSM female coupling.

The NPTF male has tapered threads and a 30° inverted seat. The NPTF female has tapered threads and no seat. The seal takes place by deformation of the threads. The NPSM female has straight threads and a 30° inverted seat. The seal takes place on the 30° seat.

The NPTF coupling is similar to, but not interchangeable with, the BSPT coupling. The thread pitch is different in most sizes. Also, the thread angle is 60° instead of the 55° angle of the British coupling.

### JIC 37° FLARE

The Joint Industry Conference (JIC) is now defunct, and this standard is included as a part of SAE J516. The JIC 37° flare male coupling will mate with a JIC female only. The JIC male and female have straight threads and a 37° flare seat. The seal is made on the 37° flare seat.

Some sizes have the same threads as the SAE 45° flare. Carefully measure the seat angle to differentiate between the two.

### SAE 45° FLARE

The SAE 45° flare will only mate with an SAE 45° flare female. Both male and female couplings have straight threads and a 45° flare seat. The seal is made on the 45° flare seat.

Once again, because some sizes of this coupling have the same threads as the JIC 37° flare, carefully measure the seat angle to identify the correct coupling.

### SAE STRAIGHT THREAD O-RING BOSS

The O-ring boss male will only mate with an O-ring boss female, and the female is generally found on ports.

The male has straight threads and an O-ring. The female has straight threads and a sealing face. The seal is made at the O-ring on the male and the sealing face on the female.

### O-RING FACE SEAL

The solid male O-ring face seal fitting will mate with a swivel female O-ring face seal only. An O-ring rests in the O-ring groove in the male coupling. The seal is made when the O-ring in the male contacts the flat face on the female coupling.

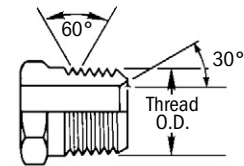

**NPTF male**

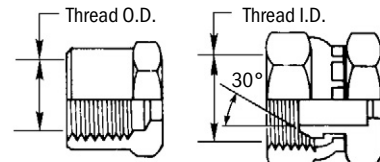

**NPTF female**

**NPSM female**

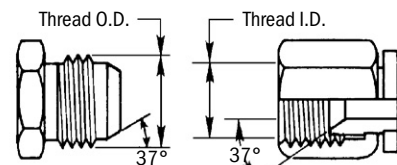

**JIC 37° male**

**JIC 37° female**

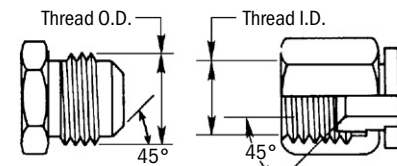

**SAE 45° male**

**SAE 45° female**

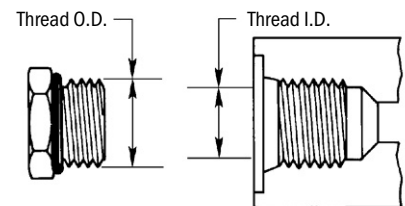

**O-ring boss male**

**O-ring boss female port**

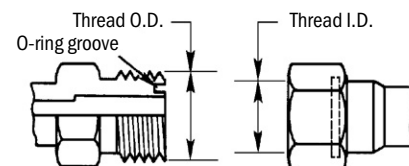

**O-ring face seal  
solid male**

**O-ring face seal  
swivel female**

**CONTINUED ON NEXT PAGE**

## COUPLING SELECTION

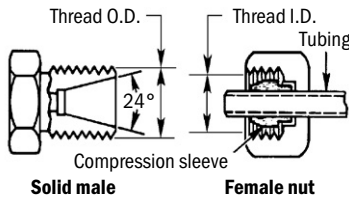
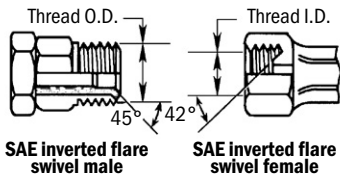
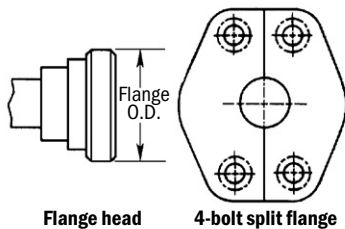
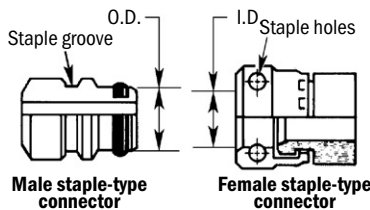
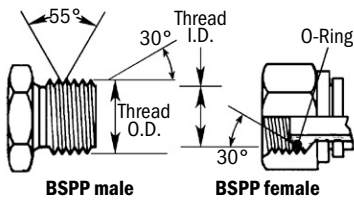
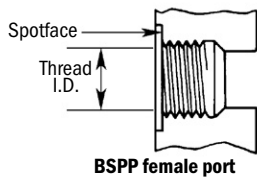
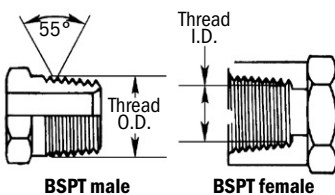
**Solid male**
**Female nut**

**SAE inverted flare swivel male**
**SAE inverted flare swivel female**

**Flange head**
**4-bolt split flange**

**Male staple-type connector**
**Female staple-type connector**

**BSPP male**
**BSPP female**

**BSPP female port**

**BSPT male**
**BSPT female**

### NORTH AMERICAN STANDARDS (CONTINUED)

#### FLARELESS TUBE

The flareless solid male only mates with a female flareless nut and compression sleeve. The male has straight threads and a 24° seat. The female has straight threads and a compression sleeve for a sealing surface. The seal is made between the compression sleeve and the 24° seat on the male, and between the compression sleeve and the tubing on the female.

#### SAE INVERTED FLARE

The SAE 45° inverted flare male will only mate with an SAE 42° inverted flare female. The male has straight threads and a 45° inverted flare. The female has straight threads and a 42° inverted flare. The seal is made on the 45° flare seat on the male and the 42° flare seat on the female.

#### SAE CODE 61 AND CODE 62 4-BOLT SPLIT FLANGES

These two couplings are used worldwide, usually as a connection on pumps and motors for extremely high-pressure lines. There are four exceptions:

- The dash 10 size, which is common outside of North America, is not an SAE standard size.
- Caterpillar flanges, which have the same flange O.D. as SAE Code 62, have a thicker flange head, and require different flange halves, clamps and bolts.
- Poclair flanges are completely different from SAE flanges and are not interchangeable.
- Komatsu flanges are dimensionally the same as SAE flanges except for their O-ring grooves.

#### STAPLE TYPE

The seal on these connectors is made when the O-ring on the male contacts the inside surface of the female. The two connectors are held together with a staple. Staple-type couplings are commonly found on mining equipment worldwide.

### BRITISH STANDARDS

There are two types of British couplings—British Standard Pipe Parallel (BSPP) and British Standard Pipe Tapered (BSPT). The British couplings are widely used in the United Kingdom, France, Scandinavia, Japan, and British Commonwealth countries such as India, Australia and New Zealand. These components are widely available in Europe.

#### BSPP

The BSPP male and female have straight threads and a 30° seat. The female port has a spotface. The seal on the port is made with an O-ring or a soft metal washer on the male. The BSPP coupling is similar to, but not interchangeable with, the North American NPSM coupling. The thread pitch is different in most sizes, and the thread angle is 55° instead of the 60° angle found on most NPSM threads.

#### BSPT

The BSPT male has tapered threads. The BSPT male will mate with either a BSPT female or a BSPP female. When mating with either the BSPT or BSPP female port, the seal is made on the threads. The BSPT coupling is also similar to a North American coupling, the NPTF. The thread pitch is different in most cases, and the required thread angle is 55° instead of the 60° angle found on NPTF threads. The major applications for BSPP and BSPT hydraulic couplings would include most connections on British-built hydraulic components such as valves and cylinders.

## JAPANESE STANDARDS

There are four major Japanese Industrial Standard (JIS) couplings—JIS 30° flare parallel thread, JIS tapered pipe thread, Komatsu-style 30° flare and Komatsu-style flange. The couplings are used primarily in Japan and the United Kingdom.

### JIS 30° FLARE PARALLEL THREAD

The JIS 30° flare male coupling will mate only with a JIS 30° flare female. The male and female have straight threads and a 30° seat. The seal is made on the 30° seat.

The threads on the JIS 30° flare coupling are the same as the BSPP threads, and both the Japanese and British couplings have a 30° seat. However, these couplings are not interchangeable because the British seat is inverted.

### JIS TAPERED PIPE THREAD

The JIS tapered pipe thread coupling is identical to and fully interchangeable with the BSPT coupling. The seal on the Japanese pipe thread coupling is made on the threads.

### KOMATSU-STYLE 30° FLARE PARALLEL THREAD

The Komatsu-style 30° flare parallel thread coupling is identical to the JIS 30° flare parallel thread coupling except for the threads. The Komatsu style uses metric fine threads. The Komatsu-style coupling seals on the 30° flare.

### KOMATSU-STYLE FLANGE FITTING

The Komatsu-style coupling is nearly identical to and fully interchangeable with the North American SAE Code 61 flange fitting. In all sizes, the O-ring dimensions are different. When replacing a Komatsu-style flange with an SAE flange, an SAE O-ring always must be used.

All popular equipment manufactured by Komatsu uses Komatsu couplings. Most other Japanese equipment uses JIS 30° couplings, although some use BSPP 30° couplings. Other popular couplings, such as North American SAE (JIC) 37° flare, are also found on Japanese equipment.

## GERMAN STANDARDS

There are four main German Deutsche Industrial Norme (DIN) couplings—DIN 24°, DIN 60°, DIN 3852 Types A and B, and DIN 3852 Type C. The DIN couplings are used primarily in Germany and less frequently in Western and Eastern Europe. Availability is very good in Europe but limited elsewhere.

### DIN 24°

The DIN 24° couplings are the most common German couplings. The DIN 24° cone male will mate with the female 24° cone with O-ring, female metric tube, and female universal 24° or 60° cone. The male has a 24° seat, straight metric threads and a recessed counterbore which matches the tube O.D. of the coupling used with it.

There is a light and heavy series DIN coupling. Proper identification is made by measuring both the thread size and the tube O.D. (The heavy series has a smaller I.D. and thicker wall than the light series of the same O.D.) When measuring the flare angle with a seat angle gauge, use a 12° gauge. The seat angle gauge measures the angle from the coupling centerline.

### DIN 60°

The DIN 60° coupling is not commonly used. The DIN 60° cone male will mate with the female universal 24° or 60° cone couplings only. The male has a 60° seat and straight metric threads.

When measuring the flare angle with the seat angle gauge, use the 30° gauge.

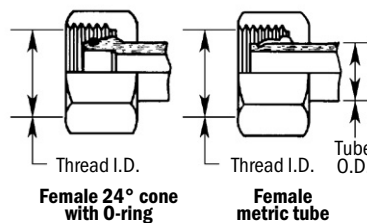
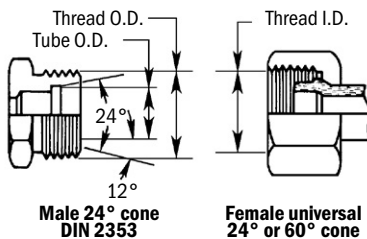
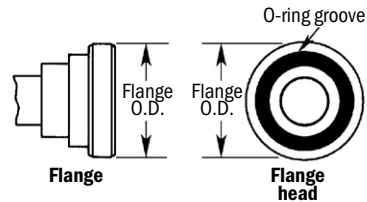
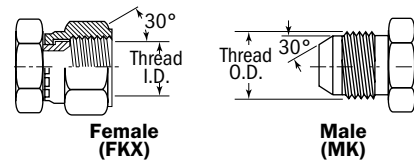
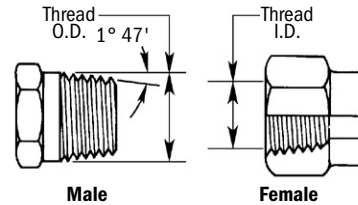
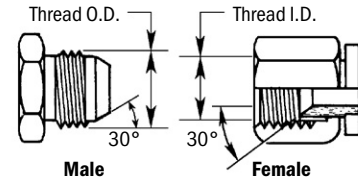

**CONTINUED ON NEXT PAGE**



# COUPLING SELECTION

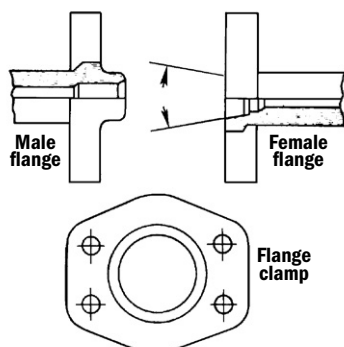
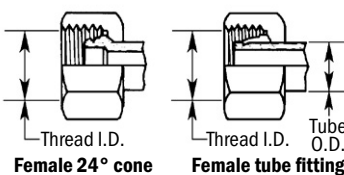
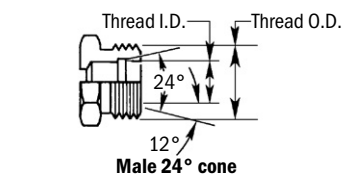
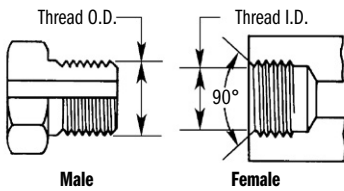
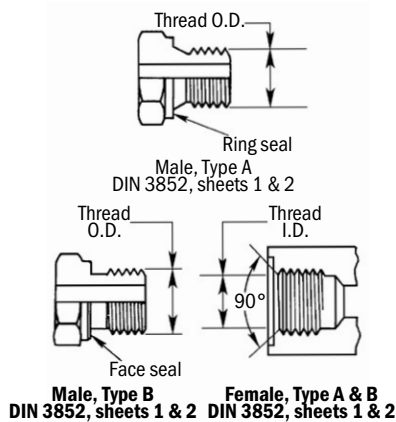
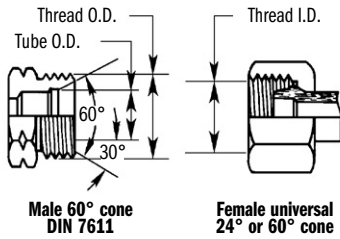

## GERMAN STANDARDS (CONTINUED)

### DIN 3852 TYPES A AND B

The male DIN 3852 A and B couplings will mate only with a matching DIN 3852 A and B female. The male and female A and B couplings have straight threads, but these threads can be either metric or British-designed Whitworth threads. (The reason for Whitworth threads on German components is that, historically, Britain built much of the world's mining equipment. Germany machined couplings to fit the equipment.) The seal occurs when the ring seal (Type A) or the face (Type B) mates with the face of the female port.

There are two series of the Types A and B couplings—the light (L) and the heavy (S) series. This is a very common German port connection.

### DIN 3852 TYPE C

Type C couplings are tapered threads. They are also available with either metric or Whitworth threads. The seal takes place on the threads.

There are three series of Type C couplings—extra light (LL), light (L) and heavy (S).

Type C is also a port connection.

Tapered threads (Type C) are less popular than straight threads (Types A and B). Again, the Whitworth threads are generally found on mining equipment.

## FRENCH STANDARDS

There are two major types of French (GAZ) couplings—24° flare and GAZ 24° flange.

These couplings are used primarily on French equipment and are not broadly used in other parts of the world.

### GAZ 24° FLARE

The French metric (GAZ) 24° flare coupling will mate with a female with either a 24° cone or the female tube coupling. The male has a 24° seat and straight metric fine threads. The female has a 24° seat or a tube sleeve and straight metric fine threads.

When measuring the flare angle with the seat angle gauge, use the 12° gauge.

### GAZ 24° FLANGE

Also called the Poclairn 24° high-pressure fitting, this is a specialty fitting found on equipment manufactured by Poclairn. It is not commonly used.

The male flange will mate with a female flange or a port. The seal is made on the 24° seat.



## GATES COUPLING NOMENCLATURE

### FERRULE NOMENCLATURE

Ferrule-type designations (GS, GSP) correspond to the stem hose end-type designations (16GS-16FJX, etc.).

Always refer to Gates eCrimp for the right hose, stem and ferrule combination.

### COUPLING NOMENCLATURE

Gates utilizes various hose ends as follows:

#### COUPLINGS FOR WIRE BRAID HOSE

- MegaCrimp – G Series (Global)

#### COUPLINGS FOR SPIRAL HOSE

- GS – GlobalSpiral
- GSM – GlobalSpiral MAX
- GSP – GlobalSpiral Plus™

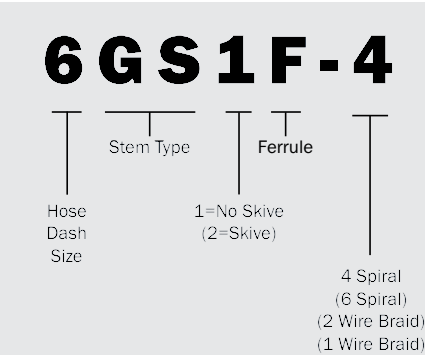

Once you've identified the thread end, it is important to put it into correct nomenclature.

With a two-piece system, both stem and ferrule must be identified.

#### OTHER HOSE ENDS

- PCTS – Power Crimp™ T/P Swage for Thermoplastic Hose
- C14 – For PTFE Hose
- GL – For Low-Pressure Return and Suction Hose
- ACA, ACC, ACB – Air Conditioning for Refrigerant Hose

#### FIELD ATTACHABLE COUPLINGS

- C5 Series – For C5 Hoses
- C1T – For G1
- LOC – For LOL and LOC

## GATES GLOBAL PART NUMBERING SYSTEM

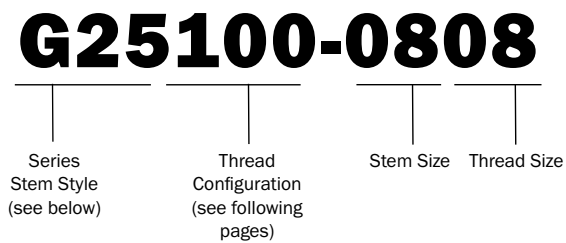

### SERIES STEM STYLES:

**G17** Stainless Steel Braid Couplings

**G18** Stainless Steel Spiral Couplings

**G19** G8K Couplings

**G20** GlobalSpiral Couplings

**G21** GlobalSpiral One Piece Couplings For MC4-20 Crimper

**G22** GlobalSpiral Plus (GSP)

**G23** GlobalSpiral Max (GSM) Pressure Couplings (-32)

**G24** GlobalSpiral Max (GSM) Pressure Couplings (-24)

**G25** MegaCrimp Couplings

**G27** Field Attachable Type T for G1 Hose (1 Wire)

**G28** Field Attachable Type T for G2 Hose (2 Wire)

**G33** Air Brake Couplings For Rubber Hose

**G34** Field Attachable for C5CXH, C5C, C5D & C5M Hose

**G35** Field Attachable for C5E Hose

**G36** Brass Lock-On Field Attachable Couplings for LOC & LOL Hose

**G37** Single Bead

**G38** Barbed Stem

**G40** C14 Couplings

**G43** GL Couplings

**G44** GLX™ Couplings

**G45** PolarSeal Couplings (ACA)

**G46** PolarSeal II Couplings (ACC)

**G47** PolarSeal II Couplings (ACB)

**G50** Power Steering Couplings

**G51** PCTS Thermoplastic Couplings



## ADDITIONAL SELECTION CRITERIA

### END CONFIGURATION SELECTION

It is important to keep in mind that the hose assembly—couplings and hose—is only one component of the system. In choosing the correct end terminations for the couplings attached to the hose, formal design standards and sound engineering judgment should be used.

In the absence of formal design standards, an engineer should consider the factors located in the sidebar when choosing the proper end termination.

If there are any questions as to what end fittings should be used, Gates recommends that you consult your Gates sales representative or the Product Application Group for assistance.

### CORROSION RESISTANCE

Most hydraulic fittings are manufactured from carbon steel and have zinc dichromate plating for corrosion resistance. Tested under SAE J516 and ASTM B117 salt-spray conditions, our revolutionary TuffCoat Xtreme plating provided 840 hours of protection against corrosion. That's a 1,000% improvement over the 72-hour SAE and 96-hour OE industry standards.

### VIBRATION

Coupling selection may be influenced if the end connection has quite a bit of motion and/or vibration, which can potentially weaken or loosen a connection. Use of split flange couplings, or other couplings that use an O-ring for sealing, perform better under vibration. Avoid use of couplings that seal on the threads.

### TEMPERATURE

Metal surfaces can expand and contract under extreme temperature fluctuations. Choose couplings that use O-rings for sealing. The O-ring will seal as the metal moves. It may be necessary to use O-ring materials that are suitable for high temperatures. Also, use a fitting material that is best suited for the application's temperature (i.e., if the application is high temperature, avoid using brass or aluminum).

### FLUID COMPATIBILITY

While hydraulic hose is commonly selected by its compatibility with fluid, couplings usually are not. Couplings can, however, be affected by the fluid. Always check the chemical resistance charts for compatibility with coupling materials and O-rings.

### PRESSURE

Working pressure should be a consideration when selecting a fitting. Some fittings don't seal well at high pressures and can develop a leak. O-ring-type fittings, as well as solid port connectors, work well at high pressures. Avoid the use of swivel staked nut couplings at extremely high pressures.

### USE OF ADAPTERS

You may want to select a coupling based on the need of adapters. Some couplings connect directly to a port, while others connect to adapters. Connecting directly to the port eliminates the need for an additional connection but can make installation more difficult. Adapters can make installation easier, eliminate the need for coupling orientation, but introduce an additional connection or possible leak point.

In the absence of formal design standards, an engineer should consider the following factors in choosing the proper end termination:

- Pressure
- Impulse frequency, amplitude and waveform
- Vibration
- Corrosion
- Dissimilar metals (galvanic corrosion)
- Maintenance procedures and frequency
- Installation reliability
- The connection's risk in the system
- Exposure to the elements
- The operator's and bystander's exposure to the connection
- Installation, operation, and service activities and practices that affect safety

### EXPERT ADVICE



**NOTE:** Some male swivel-type couplings have internal O-rings. Fluid compatibility with the O-rings must also be considered.

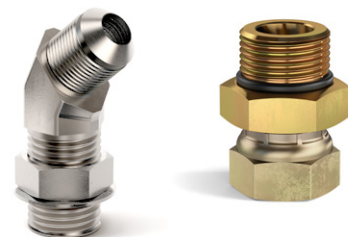

# PROPER HOSE ASSEMBLY

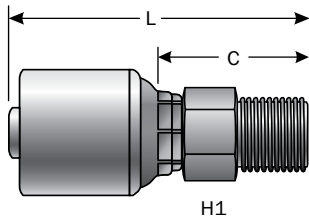

Male Pipe

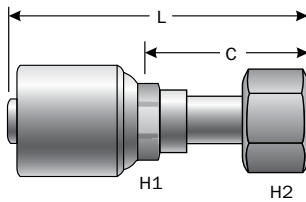

Female Flat-Face Swivel

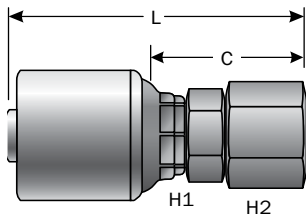

Female JIC

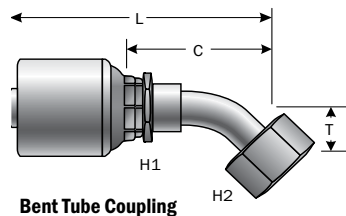

Bent Tube Coupling

## MEASURING AND CUTTING HOSE

Once the proper hose and couplings have been selected, the assembly can now be made. There are three types of assemblies:

1. Permanent crimped.
2. Permanent swage.
3. Field attachable.

Components, equipment and procedures vary for all types. However, measuring, cutting procedures and fitting orientation are the same.

### MEASURING HOSE

With some assemblies, the length must be within a tight tolerance for proper installation. This is especially true for short high-pressure hose assemblies.

Before cutting the hose, make sure you understand the difference between “cut hose length” and “assembly overall length” as shown below.

Cut-off value “C” is the length of that part of the coupling not directly in contact with or applied to the hose. Subtract the sum of the two “C” values from the total length of the assembly to determine the approximate hose length to be cut.

All cut-off values are identified in the coupling tables found in Gates hydraulic catalog 35093.

For male thread couplings, the cut-off is measured from the locking collar to the end of the threads.

For straight female couplings, the cut-off is measured from the locking collar to either the end of the nut or seat, depending on whether the nut can be pulled back exposing the seating surface.

Bent tube couplings are measured to the centerline of the seating surface.

## CUT HOSE LENGTH = ASSEMBLY OVERALL LENGTH MINUS (C1 + C2)

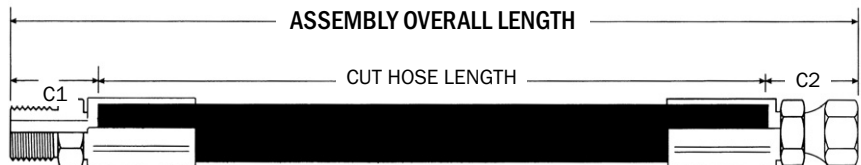

### SAE LENGTH TOLERANCES FOR HYDRAULIC HOSE ASSEMBLIES AND SPECIFIED HOSE LENGTHS

LENGTH	TOLERANCE
For lengths up to 300mm	+/-3mm
For lengths 301mm to 450mm	+/-5mm
For lengths 451mm to 900mm	+/-7mm
For lengths 901mm and above	±1% of length measured to the nearest whole mm

#### EXPERT ADVICE



When cutting hose, always wear safety glasses and avoid loose-fitting clothing. Hearing protection is also strongly recommended.

## CUTTING HOSE

After determining the cut hose length by deducting for fittings, cut the hose with a cut-off saw. There are two blade types that can be used—notched (serrated) or abrasive.

The notched blade gives a clean, efficient cut on non-spiral-reinforced hose (one- and two-wire braid hose and textile hose). Though notched blades will cut spiral hose, they are not recommended as they dull quickly and/or become damaged.

The abrasive wheel efficiently cuts all hose types, including spiral-reinforced hose. The drawback with this blade is the amount of debris it creates from cutting. As the blade wears out, its diameter becomes smaller and eventually requires replacement.

Once you've installed the appropriate blade, place the hose in the bending fixture. This draws the hose away as you cut, minimizing binding (squeezing) and making cutting easier. Handheld cutters can be used on some textile-reinforced hose.

Cutting PTFE hose requires special consideration. It can be cut cleanly with a cutting shear. An abrasive wheel can also be used, but the hose's cutting location must be wrapped with heavy-duty masking tape (at least twice). Once the cut is made, the PTFE tube must be deburred using a sharp knife. Remove the tape prior to assembly.

**NOTE:** Cutting of any hose will generate some debris that if not properly removed can damage the hydraulic system. (See page 49 for more information on hose cleanliness.)

When cutting any hose, keep the cut as straight as possible and square with the side of the hose. The maximum allowable angle of the cut is 5° (as shown in the sidebar).

## FITTING ORIENTATION

Fitting orientation is necessary when neither fitting is straight (both are at an angle). Fittings must be oriented to each other to ensure proper installation with minimal stress on the hose from twisting.

Orientation procedure:

1. Position far coupling vertically downward.
2. Orientation angle is measured clockwise.

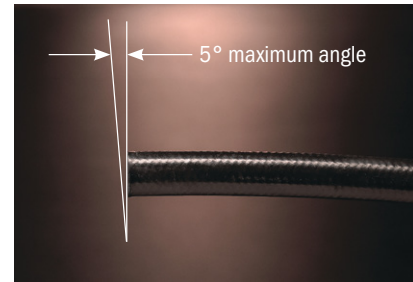

### Correct Insertion Depth Made Easy

Confirm the proper insertion depth for all Gates wire braid hydraulic hose with the Gates MegaCrimp coupling insertion tool. Made of lightweight solid aluminum, and designed to mount either on top or on the side of a workbench, it has a slot for holding a marking pen or grease pencil.

To use, just locate the slot with the correct dash size (marked on both top and side), insert the hose and push it all the way in. Check to ensure the cut is square (the maximum allowable angle of cut is 5°). Then mark the insertion depth on the hose. Now you can easily see if the coupling is properly seated on the hose before you crimp.

To order the tool, ask for product no. 7482-1342/part no. 78017.



## PROPER HOSE ASSEMBLY

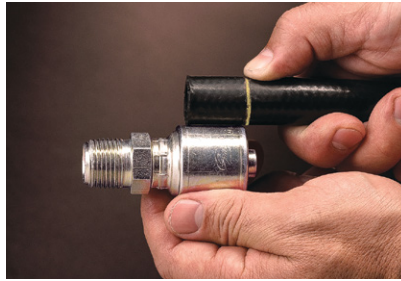
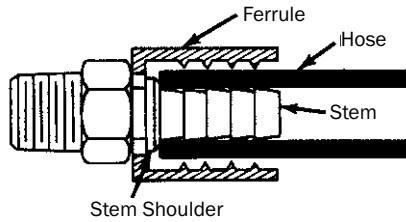

### EXPERT ADVICE



**WARNING:** An incorrect hose assembly can rupture or blow apart in use, resulting in serious injury, death or property damage.

**FOR SAFETY'S SAKE, USE A CRIMPER ONLY IF YOU:**

1. Receive hands-on training with Gates crimpers and assemblies.
2. Follow current Gates operating manual and crimp data for the Gates crimper. For the most current crimp data, refer to Gates Electronic Crimp Data (eCrimp) at [ecrimp.gates.com](http://ecrimp.gates.com).
3. Use only new (unused) Gates hose and fittings.
4. Wear safety glasses.

**REMEMBER:** Others depend on you to make correct assemblies.

## HOSE PREPARATION

### PREASSEMBLY USING TWO-PIECE FITTINGS (P, GS & GSP)

1. Lubricate the first two or three serrations on the stem with lightweight oil.
2. Clamp stem in vise on hex portion and push hose onto stem. Hose should be flush against the stem shoulder.
3. Cutaway of assembly below shows the hose has bottomed against stem shoulder. To check for full insertion, pull the ferrule down. The stem shoulder should be level with the top of the ferrule.
4. Push ferrule so it rests against hex of stem. Hose and coupling are now ready for crimping.

### PREASSEMBLY USING ONE-PIECE FITTINGS (MEGACRIMP & GSM)

MegaCrimp was designed for easy insertion. No oil is needed for lubrication.

1. Place the hose next to the coupling. Use your thumb or mark the depth of insertion.
2. With your thumb (or mark) in place, push the coupling until the shell touches the tip of your thumb (or mark). Twist it slightly to ensure it is fully inserted.

## CRIMP PROCEDURES

### LISTED BELOW ARE BASIC CRIMP PROCEDURES.

For specific instructions for your crimper, please refer to the appropriate operator's manual.

1. Always wear safety glasses, and keep hands and clothing away from moving parts.
2. Refer to crimp data chart for:
  - Skive data (if necessary)
  - Die selection
  - Finished crimp diameter
  - Approximate crimp setting

For the most current crimp data, refer to Gates Electronic Crimp Data (eCrimp) at [ecrimp.gates.com](http://ecrimp.gates.com) or access the Gates eCrimp mobile app on your smart phone.

3. Load the selected dies into the crimper. When using a die set for the first time, apply a thin coat of lubricant to the contact surface and cone (not the bore of the die). This layer of lubricant must be thinly reapplied when contact surfaces become shiny. Locate dies in crimp position.
4. Adjust the machine to the proper crimp setting. Gates Tablet enabled crimpers load the setting for you, just select the hose and coupling you need to crimp.
5. Adjust the depth stop (if necessary).
6. Insert the assembly and locate with the die fingers.
7. Install die cone if used.
8. Activate crimp mechanism.
9. Remove assembly from dies and measure crimp diameter.

To properly measure a crimp diameter:

1. Measure halfway between ridges. When using dial calipers, be sure the caliper fingers do not touch the ridges.
2. Measure halfway down the crimped portion of the ferrule.
3. When measuring small crimp diameters (3/16" and 1/4"), a set of jaw-type micrometers is recommended.
4. Do not measure the top of the code identification marks.

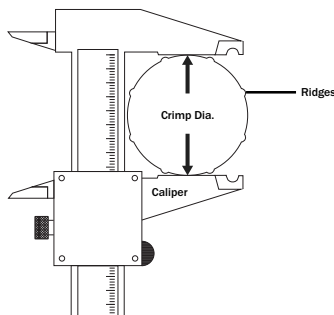

Measuring -8 and larger couplings

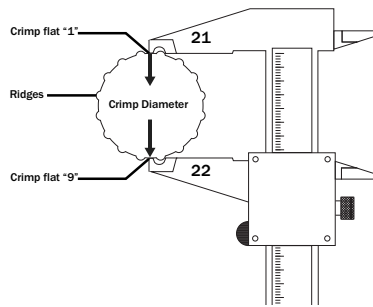

Measuring -4 and -6 couplings

If the actual crimp diameter isn't within the recommended crimp tolerance, you may need to check the calibration of the machine and recalibrate, if necessary. If the machine is properly calibrated, you'll need to make a slight adjustment to the setting.

Refer to the manual for the specific crimper in use for the correct calibration procedure. Tablet enabled crimpers have the user manuals on-board for quick and easy access.

#### PERMANENT SWAGE PROCEDURES (PCTS & C14)

Mark hose for proper insertion depth into coupling. See Gates swage data chart for insertion depth. Use a lightweight oil to lubricate the inside diameter of hose. Place the coupling hex into a vise and insert hose to insertion depth.

The following are the basic swage procedures. For specific instructions for your crimper or swager, please refer to the appropriate operator's manual.

1. Insert the correct die and pusher into the swaging machine. Refer to Gates swage data chart for die/pusher information.
2. Lubricate inner bore surfaces of dies with a thin film of lightweight oil.
3. Feed hose assembly through the dies, and hold hose and coupling into the pusher.
4. Pull control lever while guiding coupling into the die, until pusher bottoms against top of die surface.
5. Push control lever to retract the pusher and open the die halves. Remove swaged hose assembly.

Gates swage operating manuals are listed in the sidebar.

#### EXPERT ADVICE



#### IMPORTANT SAFETY NOTE:

All settings are approximate. Machining tolerances exist for each crimper, die set and supporting piece of equipment which will affect your actual setting. Always check the crimp diameter to ensure that it is within the published limits. Record your actual crimper setting to achieve the specified crimp diameter for future use. Failure to heed this message could result in improperly made assemblies, blowing the hose out of the fittings at high pressure, and risk of fire and/or serious injury.

Never reuse a stem which has been previously crimped and salvaged by cutting away the ferrule. Never reuse or recrimp hose which has been in service.

CRIMPER	MANUAL FORM NO.
701/707/709	35019-AG
MobileCrimp™ 4 20 (Digital Dial)	35032 DD
(Positive Stop)	35032 PS
GC32TSi™	34012
GC96™	35016
SC32™	35019-SC

EQUIPMENT	MANUAL FORM NO.
HS-1 Hand Swager	35019-MB
Thermoplastic Swage Data Charts	35068-A
C14 PTFE	35493-B



# PROPER HOSE ASSEMBLY

## EXPERT ADVICE



**WARNING:** An incorrect hose assembly can rupture or blow apart in use, resulting in serious injury, death or property damage.

### FOR SAFETY'S SAKE, USE SWAGERS ONLY IF YOU:

1. Receive hands-on training with Gates swagers and assemblies.
2. Follow current Gates operating manual and swage data for the Gates swager.
3. Use only new (unused) Gates hose and fittings.
4. Wear safety glasses.

**REMEMBER:** Others depend on you to make correct assemblies.



## FIELD ATTACHABLE PROCEDURES

“Field attachable” means no crimper is needed to attach the couplings. Below are the basic steps in the assembly of “field attachable” couplings.

### INSTALLATION OF GATES FIELD ATTACHABLE “TYPE T” COUPLING

1. Be sure to thoroughly oil hose and nipple.
2. Put socket in vise. Turning clockwise, thread hose into socket until hose bottoms on inside shoulder of socket. Then turn hose back one-half turn.
3. In clockwise motion, thread stem into hose and socket until stem hex shoulders against ferrule.

## HOSE CLEANLINESS

As your customers become more dependent on ISO standards, your overall strategy must reflect a dedication to system cleanliness.

### WHAT IS HYDRAULIC SYSTEM CLEANLINESS?

“Cleanliness” is a term used to describe the level of solid and liquid contamination found in hydraulic systems. “Contamination” may be defined as any substance that is not part of the hydraulic system’s working fluid.

### WHY IS CLEANLINESS IMPORTANT TO YOUR CUSTOMERS?

**Efficient production** because clean systems provide for maximum productivity.

**Improved control** of spare parts through preventive maintenance and monitoring contamination.

**Reduce equipment downtime** through scheduled inspections.

**Safety hazards minimized** through preventing contamination-related failure for increased life expectancy of components on equipment.

**Reduced repair cost** due to fewer breakdowns.

Several reputable sources have claimed that 70 to 80 percent of hydraulic system failures are due to contamination. By establishing a contamination control program, costly repairs and downtime may be minimized. A contamination control program can be as simple as establishing an allowable level of contamination within a hydraulic system, supplying cleaned components for the system, and monitoring levels of contamination as part of a preventive maintenance program.

### HOW DOES THIS “CONTAMINATION” GET IN THERE?

Origins of contamination may be from system components themselves, the hydraulic working fluid, the outside environment, or even generated by the system itself. These contaminants, some large and some microscopic, can have a profound impact on the performance and longevity of the hydraulic system. There are three principal means through which contamination can occur in a typical hydraulic system. It can be:

1. Generated during system operation.
2. Built into the system during assembly.
3. Ingested by the system during operation.

For optimum performance, the working fluid in hydraulic systems should be as homogeneous as possible and free of all visible, as well as microscopic, debris. Although the complete absence of contamination in hydraulic systems is unrealistic, an acceptable and defined level of contamination is generally considered hydraulic system cleanliness. The best approach to cleanliness is to prevent contamination in the first place. Use clean hose and couplings, and keep them clean (i.e., cap ends). Clean hose bore after cutting to length. Cutting hose to length is a major contributor to contamination.

#### HOW WORKING FLUID CONTAMINATION AFFECTS THE FOLLOWING:

**Valves** — Microscopic contamination can mill away tolerances, similar to erosion. Tolerances are used for sealing purposes. For example, on spring-centering valves, debris may get caught between the valve and wall surfaces, slowing down the motion of the valve or causing sluggish or adverse mechanical actuation. When abrasive particles enter the clearances between moving parts, they score and hone the surfaces to greater tolerances. As these tolerances broaden, system performance is compromised by pressure losses incurred due to fluid leakage from high to lower pressures.

Even worse is the occurrence when particles that are greater than or equal to the orifice openings become wedged between the surfaces. This may cause wear to occur, or it may cause the system components to seize.

**Pumps & drives** — Just as in valves, microscopic contamination can mill away tolerances, creating leak points. These leak points rob the system of pressure and cause poor responsiveness.

**System cooling** — If passages become blocked, working fluid may not flow through to remove contaminants generated from metal-to-metal contact. Lower flow rates mean greater heat buildup in systems and thermal breakdown of the working fluid.

#### METHODS OF CONTAMINATION MEASUREMENT & CONTAMINANT LEVELS

Despite efforts to totally remove all of the contaminant in a hydraulic hose assembly, some contamination remains even after the most meticulous cleaning or flushing techniques are applied. It becomes necessary to quantify varying levels of contamination to better understand the cleanliness levels in hydraulic systems.

Contamination particles are usually sized using a metric unit of measure called a micrometer, otherwise known as a micron. A micron is a very small unit of measure equivalent to 39 millionths (.000039) of an inch. 25 microns are equal to one thousandth of an inch. The human eye can discern a particle no smaller than 40 microns.

The International Standards Organization (ISO) has established three principal methods to measure the contamination level within a component, circuit or system. These three methods are widely used for cleanliness quantification.

**Gravimetric Measurement (ISO 4405)** — Reporting method that references the total mass of contaminant found in a hydraulic component. This total mass measurement is then normalized by the total internal component surface area of a hydraulic component. A fluid is used to dislodge contamination in a hose assembly and is then poured through a membrane catch filter. An analytical balance is used to measure the total mass of contaminant which has been flushed out of a component and is referenced to the surface area or volume of the assembly or component.

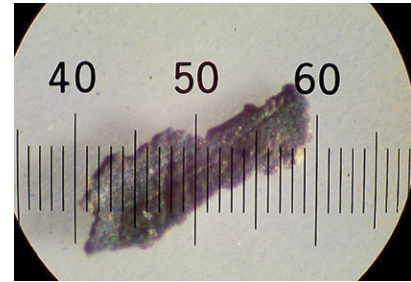

## PROPER HOSE ASSEMBLY

### EXPERT ADVICE



#### SWEEP IT CLEAN

Contaminated hydraulic assembly components shorten service life. The easiest method of cleaning a hose is to blow air through it. But that's really only a half-measure. To do the job thoroughly, Gates recommends using the Gates MegaClean™ system. Pressurized launchers and compatible nozzles blow foam projectiles through the inside surface of the hose, sweeping away fine particles of loose dirt and contaminants. The projectiles are 20–30 percent larger than the hose I.D. and leave nothing behind but a clean hose.



**Particle Size Distribution Analysis (ISO 4406 or NAS 1638)** — Reporting method to gauge both the size and number of contaminant particles in a known quantity of fluid. Either a fluid sample is taken directly out of a hydraulic system or a known quantity of fluid is used to dislodge contaminants out of a hydraulic component. This fluid is run through a particle-counting instrument to size and count contaminant particles. These particle “counts” can then be normalized by the total component volume to determine a corresponding ISO 4406 “code” level of particle contamination. Levels of 5 and 15 microns of contamination are reported on a logarithmic scale corresponding to the ISO 4406 “code” for the number of particles greater than or equal to these respective sizes per milliliter of fluid.

**Maximum Particle Size Analysis (ISO 4407)** — Evaluation that is done with a microscope. A microscope is used to size individual pieces of contaminant. Particle size is important in reference to maximum clearances of hydraulic components.

Whether hydraulic assembly cleanliness applies to you or not, it is worthwhile to understand the significant impact that contamination levels can have on the life of hydraulic system components.

Implementing a thorough cleanliness system may have a significant impact on warranty returns for hydraulically powered equipment.

Gates currently offers a system of four gravimetric (ISO 4405) levels of hydraulic assembly cleanliness to meet or exceed your customer's assembly cleanliness standards.

#### WHAT CAN GATES DO FOR YOU?

Gates has actively promoted hydraulic assembly cleanliness for over a decade with the development of a system that ensures four gravimetric levels of cleanliness for customers who deal directly with our assembly facilities.

The current Gates gravimetric system:

**Level One** — No more than 1,000 mg of contaminant per square meter of internal assembly area.

**Level Two** — No more than 300 mg of contaminant per square meter of internal assembly area.

**Level Three** — No more than 100 mg of contaminant per square meter of internal assembly area.

**Level Four** — No more than 44 mg of contaminant per square meter of internal assembly area.

Gates can measure and develop cleaning/flushing methods to furnish ISO 4406 particle counts, as well as report largest particle size (ISO 4407).

With our new particle-counting laboratories in Chambersburg, Pennsylvania, and St. Neots, in the U.K., Gates now offers certain ISO 4406 levels for supplied assemblies to customers.

Gates current system of four cleanliness levels is designed to meet a variety of system demands, both high pressures and low. Gates continues to develop new methods of cleaning hydraulic hose assemblies to ISO 4406 levels. Contact a Gates representative in your area or call Hydraulic/Industrial Hose Product Application at (303) 744-5070 for more information.

## INSTALLING HOSE ASSEMBLIES

Before installing hydraulic hose assemblies, review the safety precautions in the Safety section of this manual, as well as your equipment's operations manual. Installation varies based on coupling configurations, use of adapters and routing.

### COUPLING CONFIGURATIONS

Female swivel connections are made by rotating the swivel nut over the solid male threads. Never use a swivel female with a swivel male. Once hand-tight, use a wrench to hold the backup hex while tightening the swivel nut to proper torque. This will prevent stem rotation and hose twist.

Bent tube and block-style fittings must be held in position by hand while tightening.

Male fitting to port connections can be made using four types of configurations:

- Solid male (MP, MB, MBSPT, etc.).
- Male swivels (MPX, MBX, MIX).
- Flanges (FL, FLH, FLC, FLK).
- Block-style adapters with lock nuts.

Solid male fittings are installed by rotating the entire hose assembly as you thread the male into the port. PTFE tape should not be used on the tapered threads for hydraulic applications.

If an O-ring is used, lubricate it with oil before installation. A dry O-ring will stick and pull away from the sealing area, resulting in a poor seal.

Once hand-tight, use a wrench on the hex to properly torque the fitting. Since hose rotation is necessary, never use two solid males on the same hose assembly.

Male swivel installation does not require hose rotation. Simply thread the male into the port and use a wrench to torque properly. Since the hose does not rotate, you can orientate the hose curvature to assist in routing. Be aware that male swivels (except MIX) have internal O-rings that must be compatible with the fluid used.

Flanges are installed using split flange clamps. The following are steps for proper flange fitting installation:

1. Put a small amount of oil on the O-ring and place in the fitting groove.  
Oil will prevent the O-ring from falling out.
2. Place fitting over port.
3. Install clamp halves over flange head and thread in bolts by hand.
4. Use torque wrench to tighten using crossing pattern.
5. Torque to manufacturer's specifications.

Some block-style male port adapters use lock nuts to orient the fitting. Rotate the block and thread fitting into port. When nearly tight, hold block in position and tighten lock nut against port.

# INSTALLING HOSE ASSEMBLIES

## HOSE ASSEMBLY ROUTING TIPS

Proper hose installation is essential for satisfactory performance. If hose length is excessive, the installation's appearance will be unsatisfactory, and unnecessary equipment costs will be incurred. If hose assemblies are too short to permit adequate flexing and allow for length changes due to expansion or contraction, service life will be reduced.

Hose can elongate up to 2 percent or contract up to 4 percent depending on hose construction. Routing must take this into account.

The diagrams on the following pages show proper hose routing, which provides maximum performance and cost savings. Consider these examples in determining length of a specific assembly.

### Bend Radius

The minimum bend radius of a hose is the smallest bend the hose can be used in application without internal damage or kinking. Most hydraulic hose manufacturers list the minimum bend radius for their hose, which is based on the hose construction, pressure rating, size and wall thickness. Bend radius is measured to the inside of the curvature.

Compression-style fittings (MSP, MFA, STA, ABC, NASP, MMFA) use a bite sleeve and nut for connecting to tubing. Installation steps are as follows:

1. Make sure the tube is cut cleanly with no burrs or paint buildup.
2. Place nut, then bite sleeve over tube. Bite sleeve must be oriented with taper facing away from tube.
3. Locate tubing into male fitting and secure nut over threads. The bite sleeve will compress against the tube and seal with the male internal taper.

## USE OF ADAPTERS

Adapters can be used to make installation and orientation easier. Be aware, however, that adapters can also be a potential leak point. They can be used in the following situations:

1. To avoid fitting orientation, use a straight fitting and an angle adapter on one end. This makes installation easier and eliminates the need for orientation. However, this requires more parts and increases the number of joints for potential leakage.
2. When jump-size fittings are not available, make the jump with an adapter.
3. To ease port connection and hose installation.
4. To change to a different thread configuration, including international threads.

When using adapters, the preferred method is to install the adapter first, the hose assembly next.

## 4-BOLT FLANGES

DASH SIZE	BOLT SIZE	TORQUE
1/16 INCH	INCH	FT-LB
-8	0.31	24
-12	0.38	44
-16	0.44	44
-20	0.5	68
-24	0.63	111
-32	0.75	111

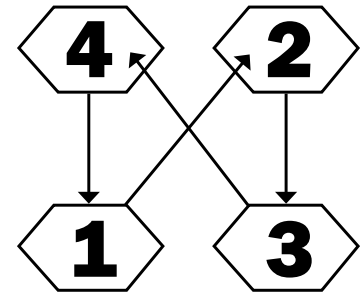

### NOTE:

1. Align faces and finger-tighten bolts before applying final torque in a pattern. The seal faces must be parallel with even bolt tension to seal properly.
2. Torque values apply to bolts which are plated or coated in light engine oil.
3. Before assembly, lubricate O-ring with light oil (SAE 10W or 20W).

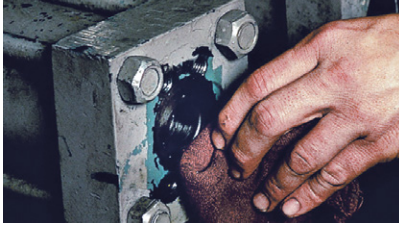

## SEVEN EASY STEPS TO INSTALL A HOSE ASSEMBLY

1. Clean the surrounding area where connections are to be made. Make sure no dirt or contamination gets into hydraulic openings.

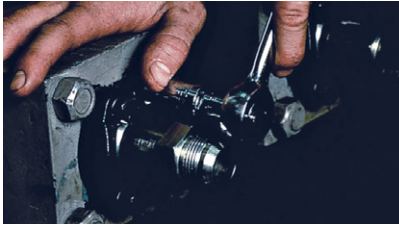

2. Install adapters into ports (if used). Torque to manufacturer's specifications.



3. Lay the hose assembly into routing position to verify length and correct routing.



4. Thread one end of hose assembly onto port (or adapter). If the hose assembly uses an angled fitting, always install it first to ensure proper positioning.



5. Thread other end of the assembly without twisting the hose. Use a wrench on the backup hex of the fitting while tightening.

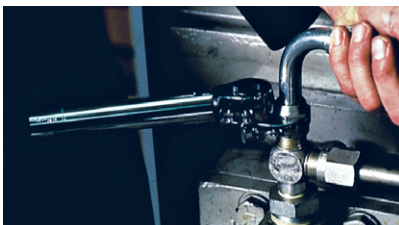

6. Properly torque both ends (see following page for torque information).



7. Run the hydraulic system to circulate oil under low pressure, and safely reinspect for leaks and potentially damaging contact. Circulating also purges air from the system that can cause sluggish performance and possible damage to pumps and other components (under no pressure).

# INSTALLING HOSE ASSEMBLIES

## HOSE ASSEMBLY ROUTING TIPS

<p><b>ABRASION</b></p> <p>Run hose in the installation so that it avoids rubbing and abrasion. Often, clamps are required to support long hose runs or to keep hose away from moving parts. Use clamps of the correct size. Too large a clamp allows hose to move inside the clamp and cause wear.</p>	
<p><b>APPEARANCE</b></p> <p>Route hose directly by using 45° and/or 90° adapters and fittings. Avoid excessive hose length to improve appearance.</p>	
<p><b>COLLAPSE</b></p> <p>To avoid hose collapse and flow restriction, keep hose bend radius as large as possible. Refer to hose specification tables for minimum bend radius.</p>	
<p><b>HIGH HEAT</b></p> <p>High ambient temperatures shorten hose life, so make sure hose is kept away from hot parts. If this is not possible, insulate hose with Gates HeatGuard™ protective sleeving.</p>	
<p><b>LENGTH CHANGE</b></p> <ol style="list-style-type: none"> <li>1. When hose installation is straight, allow enough slack in hose line to provide for length changes that will occur when pressure is applied.</li> <li>2. To allow for length changes when the hose is pressurized, do not clamp at bends so that curves will absorb changes. Do not clamp high- and low-pressure lines together.</li> </ol>	
<p><b>MOVEMENT/FLEXING</b></p> <p>Adequate hose length is necessary to distribute movement on flexing applications and to avoid abrasion.</p>	

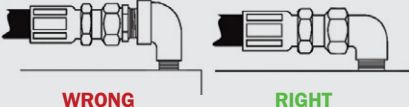
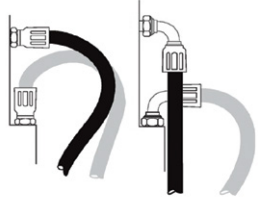
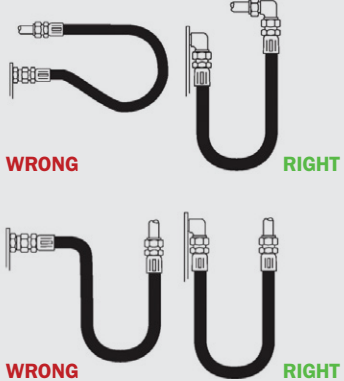
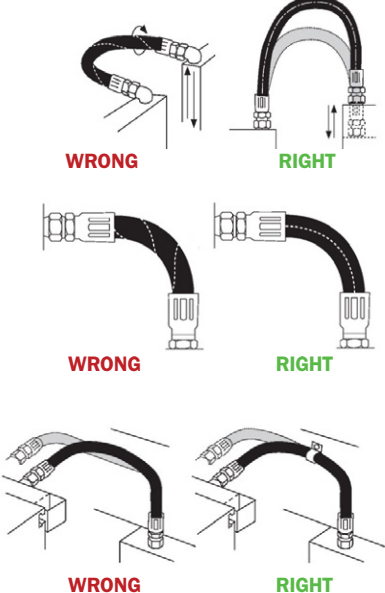
<p><b>REDUCE CONNECTIONS</b> Reduce number of pipe thread joints by using hydraulic adapters instead of pipe fittings.</p>	 <p><b>WRONG</b>      <b>RIGHT</b></p>
<p><b>STRAIN</b> Elbows and adapters should be used to relieve strain on the assembly, and to provide neater installations which will be more accessible for inspection and maintenance.</p>	 <p><b>WRONG</b>      <b>RIGHT</b></p>
<p><b>TIGHT BEND</b></p> <ol style="list-style-type: none"> <li>1. When radius is below the required minimum, use an angle adapter to avoid sharp bends.</li> <li>2. Use proper angle adapters to avoid tight bends in hose.</li> </ol>	 <p><b>WRONG</b>      <b>RIGHT</b></p> <p><b>WRONG</b>      <b>RIGHT</b></p>
<p><b>TWIST</b></p> <ol style="list-style-type: none"> <li>1. Prevent twisting and distortion by bending hose in same plane as the motion of the port to which hose is connected.</li> <li>2. When installing hose, make sure it is not twisted. Pressure applied to a twisted hose can result in hose failure or loosening of connections.</li> <li>3. Avoid twisting of hose lines bent in two planes by clamping hose at change of plane.</li> </ol>	 <p><b>WRONG</b>      <b>RIGHT</b></p> <p><b>WRONG</b>      <b>RIGHT</b></p> <p><b>WRONG</b>      <b>RIGHT</b></p>



## INSTALLING HOSE ASSEMBLIES

### EXPERT ADVICE



**CAUTION:** Over-torquing may damage nuts, adapters or sealing seats, which may result in leaks, breakage, and potential for injury or damage to property.



### EXPERT ADVICE



It is important to remember that most sleeving provides little or no operator protection. Use sound engineering judgment in the design of equipment in order to control the hazard of direct exposure of operators to fluids under pressure.

Do not use nylon sleeves when internal temperatures exceed 250°F, or if the ambient temperatures exceed 212°F, to avoid sleeving damage and personal injury. Use Gates HeatGuard sleeving.

### INSTALLATION TORQUE\*

Installation torque is very important to ensure a proper leak-free seal. Over-torquing of a threaded connection can stretch and damage threads and mating seat angles. It can also damage the staking area of a nut or possibly break a bolt on the port area. Under-torquing does not allow proper sealing.

\* Gates recommends dry torque values. Torque values in these charts are for dry (non-lubricated) threads.

If a threaded connection leaks, maintenance personnel may be inclined to tighten the connection until the leak stops. This approach may solve the leak problem, but it also may cause more damage.

Torque should first be checked before continued tightening to ensure it is within accepted limits.

The most reliable method of torquing threaded connections is to first hand-tighten the connection, then use a torque wrench to measure the torque. Torque values vary by thread configuration.

Gates Full Torque Nut technology featured on MegaCrimp and GlobalSpiral couplings resists the harmful effect of cracked nuts due to being over-torqued and resist de-torque once installed.

## ASSEMBLY TECHNIQUES AND ACCESSORIES

### BUNDLING

When installing hose assemblies, bundling techniques can improve space utilization, appearance and hose life.

Here are some tips:

1. Group and bundle similarly constructed and sized hose together using clamps, nylon straps or nylon sleeving.
2. Never bundle high-pressure hose with low-pressure hose. Under pressure, they can work against each other.
3. Never bundle rubber hose with thermoplastic or PTFE hose. Under pressure, they can also work against each other.
4. Always consider mechanical movement when bundling. Allow sufficient slack without pulling on a fitting or another hose. Bundles (like individual hose) should bend in one plane only.

### SLEEVING

A number of sleeving types are used today. The most common is nylon, which is typically used for one or more of the following:

1. To protect hoses from abrasion.
2. For use in bundling hoses.

### LIFEGUARD™ SLEEVING

Protect against pinhole leaks or hose bursts up to 5,000 psi with Gates LifeGuard sleeving. This sleeving system is an effective, economical alternative to costly metal shielding. Follow crimp procedures for assembly to contain any escaping fluids under pressure.

## SPRING GUARDS

There are many types of spring guards—flat armor, plated wire, plastic, etc. They can be used to bundle hose or provide stability and/or protection against abrasion. Also, tightly wound plated wire guards can be used as bend restrictors to ease stress on the hose.

## BEND RESTRICTORS

Bend restrictors typically are PVC sleeves which are installed near the coupling during hose assembly. They reduce bending stress in the hose to prevent damage.



Gates now offers an abrasion-resistant hose cover with far greater abrasion resistance than any standard rubber hose in the industry. Gates XtraTuff, XtraTuff Plus and MegaTuff hoses were developed to solve your abrasion problems.

TERMINATION TYPE	DASH SIZE 1/16 INCH	FLATS
JIS	-4	0.5-1.5
JIC	-4	1.5-1.75
JIC	-6	1.0-1.5
JIC	-8	1.5-1.75
JIC	-10	1.0-1.5
JIC	-12	1.0-1.5
JIC	-16	.75-1.0
JIC	-20	.75-1.0
JIC	-24	.75-1.0
JIC	-32	.75-1.0

## COUPLING AND ADAPTER INSTALLATION: FLATS METHOD

### METHOD OF VERIFYING COUPLING TORQUE

Once hand-tight, mark a straight line between the backup hex, nut and adapter hex.

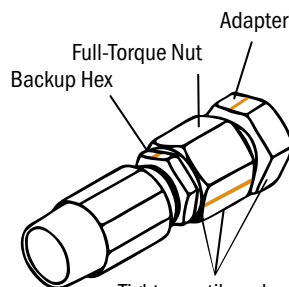
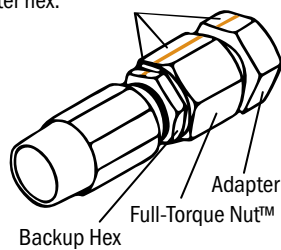

Tighten until marks are misaligned by the specified values; this example is two flats. The backup hex mark should align with the adapter mark.

### NOTE:

1. Seal faces must be in contact and the fitting fully hand-tightened before marking flats.
2. Flats method is most accurate for the first assembly cycle; for multiple disassembly/assembly cycles, torque values are more reliable.
3. Tightening two flats or more is equivalent to severe over-torque and may damage seal faces.

## COUPLING AND ADAPTER INSTALLATION: TORQUE TABLE

### JIC, SAE 45°, ORFS, O-RING BOSS, GATES ADAPTERLESS, & MEGASEAL™

DASH SIZE 1/16 INCH	JIC 37°, SAE 45° & MEGASEAL (STEEL)		JIC 37°, SAE 45° & MEGASEAL (BRASS)		FLAT FACE O-RING SEAL (STEEL)		SAE O-RING BOSS (STEEL) & GATES ADAPTERLESS ≤ 4000 PSI		SAE O-RING BOSS (STEEL) & GATES ADAPTERLESS > 4000 PSI	
	LB-FT		LB-FT		LB-FT		LB-FT		LB-FT	
	MIN	MAX	MIN	MAX	MIN	MAX	MIN	MAX	MIN	MAX
-3	8	10	5	7	-	-	7	9	7	9
-4	11	14	7	9	18	23	13	17	15	18
-5	14	18	9	11	22	28	18	23	18	23
-6	18	22	11	14	29	37	22	28	26	32
-8	36	45	23	29	41	51	37	46	52	64
-10	57	71	37	46	44	55	44	55	74	92
-12	79	99	51	64	66	83	70	88	125	157
-14	94	117	61	76	-	-	92	115	158	198
-16	108	135	70	88	92	115	111	138	199	249
-20	127	158	82	103	125	157	147	184	210	263
-24	158	198	103	129	147	184	155	193	273	341
-32	245	306	159	199	376	470	221	276	398	497

## CRIMPER PREVENTIVE MAINTENANCE

### EXPERT ADVICE



Read and follow the operating manual. This information is for general preventive maintenance.

As with other types of equipment, it is very important to properly maintain crimpers.

A typical crimper is a hydraulic ram that uses fluid under pressure to extend the ram and crimp the fittings.

Fluid flows from the pumps to the cylinder under pressure. This extends the piston, rod and pusher down on the die cone. The die cone is sloped to receive tapered die fingers. As the die cone is pushed by the hydraulic ram, the die fingers are forced (perpendicular) inward. The set of die fingers completely surrounds the ferrule to provide an even crimp.

Though there are many types and configurations of crimpers, i.e., vertical (bottom or top loading), horizontal or angled, the basic principle of operation is the same. Pumps do not have to be electronically driven. They can be manual or air-driven.

Care should be taken to properly set up and maintain these crimpers.

### CRIMPER SETUP

Here are the steps to properly set up a crimper:

1. Remove crimper and pump from shipping container.
2. Position crimper on stable surface. It's a good idea to place a rubber mat on the floor near the crimper to reduce the chance of damaging a die if dropped and to improve operator comfort.
3. Connect hydraulic hose assembly to the crimper and pump (if required). Refer to pump manual for proper port connection. Also, install the breather cap in the reservoir (tank) if needed. Fill pump reservoir with oil.
4. Make the proper electrical connections. Check to verify that the voltage and phase rating of both the crimper and power unit are compatible with the power source.
5. Bleed air from the system. Follow procedures in the crimper operations manual.
6. Lubricate all metal-to-metal sliding surfaces with a thin layer of the recommended lubricant. This includes dies, cones and die shoes.
7. Check calibration of the machine by following the procedures in the operations manual. Recalibrate as required.

### LUBRICATION

Lubricants should be reapplied to metal-to-metal sliding surfaces whenever the surfaces becomes shiny. Use only a very thin coat of Gates die grease. Failure to do so reduces the life of the dies and cone. Excessive wear on these components produces poorly performing hose assemblies that could blow apart and result in injury.

### CALIBRATION

Check the crimper's calibration at least monthly or whenever you notice a change in crimp diameter. This is critical for repeatedly producing accurate hose assemblies. Be aware that some machines calibrate automatically.



### HOSE ASSEMBLY (IF REQUIRED)

Check the hose assembly which connects the pump to the cylinder. Use the Periodic Inspections section of this manual as a guide to inspect the hose. Replace if necessary with a properly rated hose assembly. If hose assembly is not periodically checked for damage or replaced with properly rated assembly, personal injury may result.

### FLUID LEVEL

Proper fluid level in the reservoir (tank) is important for maximum crimp stroke, as well as keeping air from getting into the system. Make sure the fluid is within 1/2" from the top of the tank opening or within the sight glass if equipped.

### DIE WEAR AND STORAGE

Check the dies' sliding and crimping surfaces for wear or damage during use. Look for nicks, chips, cracks, gouges and/or other signs of wear. Replace die if any of these exist. Proper storage and lube will extend their service. Store in stable racks or in original packaging.

### CLEANING

Hydraulic fluid and lubricants can pick up dirt and debris. Clean off any buildup using a clean shop rag. Buildup can damage crimper components and produce inaccurate crimped assemblies.

### OIL CHANGE AND BLEEDING

Depending on the amount of usage, fluid should be changed periodically. Fluid viscosity can break down under high usage and temperatures. Also, component wear can contaminate the fluid. Drain and replace with the recommended fluid (see crimper and/or pump operator's manual).

## CRIMPER TROUBLESHOOTING

If your crimper isn't performing correctly, you may have to do some troubleshooting. First, determine the symptoms: What is it doing or not doing? Are all connections made properly? Is there any fluid leakage? Have any modifications been made?

The most common crimper problems fall into three categories—cylinder seal, electrical or pump.

### CYLINDER SEAL

A seal is used between the piston and cylinder that provides the proper seal under pressure. In time and with usage, these seals can wear and eventually leak or roll. Fluid leakage is a sign that seal replacement is necessary. Also, if the piston (ram) jams in the cylinder, the seal may need replacement.

### ELECTRICAL

Electrical problems can be difficult to troubleshoot. Make sure the power source is compatible with the crimper and pump. Replacement components are available if necessary.

### PUMP

Pump components can be damaged from debris in fluid, low-temperature operation or air in the system. Debris may cause a valve to stick; low temperatures thicken the fluid and can cause component damage; and air can damage pump components.

## eCRIMP DATABASE

### CRIMP WITH THE PRECISION OF GATES.

Quickly find hose and hydraulic crimp specifications at [gates.com/eCrimp](http://gates.com/eCrimp).

Gates eCrimp database allows Gates end users and distributors to find and print the most up-to-date crimp specifications for Gates hydraulic and industrial hose products. It provides crimping instructions, crimp diameter, and maintenance and troubleshooting information.

Use eCrimp to:

- Reduce downtime with hose assembly guides.
- Eliminate potential dangers of an improperly crimped hose.
- Quickly and easily find exact crimping specifications from your browser or smart phone.



## CRIMPER PREVENTIVE MAINTENANCE

PROBLEM	SOLUTION
<b>RAM WON'T RETURN (STUCK)</b>	<p>Slowly loosen the hose assembly from the pump. Be prepared to catch the fluid as it escapes.</p> <p>If no fluid escapes, the piston seal in the crimper must be damaged. Replace the seal using the proper seal replacement kit and instructions.</p> <p>If fluid escapes through the hose assembly, the check valve in the pump must be stuck. It may need cleaning and/or replacement. Contact your local Gates representative.</p>
<b>DIGITAL DISPLAY IS BLANK</b>	<p>Check all electrical wiring to make sure connections are made properly. The wrong voltage supplied to the digital display will damage it and require replacement. If all connections are made properly, the display may have been damaged. Identify the source of the damage and replace the digital display.</p>
<b>DIGITAL DISPLAY IS INCORRECT</b>	<p>A faulty digital display is not likely to be the cause. Check for proper electrical connections, including the back of the display itself. Also, check for proper calibration.</p> <p>If everything seems to be correct, replace the switchbox.</p>
<b>CYLINDER IS LEAKING FLUID</b>	<p>If field repairable, disassemble the cylinder using the proper seal replacement instructions and check the cylinder wall for scoring or damage. If the cylinder is damaged, it will require rework. If the cylinder is not damaged, replace the worn seal using the seal replacement kit.</p>
<b>BROKEN DIE FINGERS OR DIE CONE</b>	<p>Check the crimp specifications to ensure the proper die, hose, cone and setting are being used. Also, check the calibration. A broken die finger is usually the result of damage from a fall or improper use of the notched die cone. A broken cone (usually the notched cone) may also be the result of a fall or improper use. Replace all broken or damaged parts.</p>
<b>CRIMPER WON'T PLUG INTO POWER UNIT</b>	<p>Check the voltage rating on both the power unit and the crimper for compatibility. A 115-volt connector differs from a 230-volt connector. Return and replace the incorrect component (pump or crimper) or contact your local Gates representative.</p>
<b>OVER- OR UNDER-CRIMPING</b>	<p>Check calibration following the standard procedures in the operator's manual or on crimper decal. Adjust the actuator rod or switchbox position as necessary.</p> <p>Also, check the crimp specifications.</p>

## GLOSSARY OF TERMS

<b>ABRASION, HOSE</b>	The wearing, grinding or rubbing away of material. The products of abrasion will be introduced into the system as generated particulate contamination.
<b>ACCUMULATOR</b>	A container in which fluid is stored under pressure, most commonly with a gaseous space above the fluid.
<b>AIR BREATHER</b>	A device permitting air movement between atmosphere and the component in which it is installed.
<b>BAR</b>	A unit of pressure based on newtons per square meter, approximately equal to 14.5 psi. This unit is not preferred in SI metrics.
<b>BEND RADIUS</b>	The radius of a bent section of hose is always measured to the innermost surface of the curved portion.
<b>BUFFING</b>	The partial removal of the hose cover in order to put on a coupling. A stone wheel is typically used to grind or buff the cover.
<b>BUNDLING</b>	Grouping numerous hoses together.
<b>BURST PRESSURE</b>	The pressure that causes rupture. Reference pressure is intended for destructive testing purposes and design safety factors only.
<b>CAVITATION</b>	A localized gaseous condition within a liquid stream causing the rapid implosion of a gaseous bubble.
<b>CLEANLINESS LEVEL</b>	The measurement of contamination level.
<b>COMPONENT</b>	A device in a system or circuit that performs a given function (i.e., pump, valve, motor, etc.).
<b>COMPRESSIBILITY</b>	The change in volume of a unit volume of a fluid when subjected to a unit change of pressure.
<b>CONTAMINANT</b>	Any material or substance that is unwanted or adversely affects the fluid power system or components or both.
<b>CORROSION</b>	The chemical change in the mechanical elements caused by the interaction of fluid or contaminants or both. More specifically related to chemical changes in metals. The products of change may be introduced into the system as generated particulate contamination.
<b>CRIMP</b>	A method of permanently attaching hose ends.
<b>CUT-OFF LENGTH</b>	The length of that part of the coupling not directly in contact with or applied to the hose. Subtract the sum of the cut-off length of the two couplings from the total length of the assembly, and you will have the approximate cut hose length to be replaced.
<b>DASH SIZE</b>	A shorthand method of denoting the size of a particular end fitting or the inside diameter of a hose. Measured in 1/16 of an inch (i.e., -4 = 4/16 or 1/4).
<b>EFFUSION</b>	The process where chemical molecules move through the hose tube and escape from a hose.
<b>EPA</b>	Environmental Protection Agency.
<b>FITTING</b>	A connector or closure for fluid power lines and passages.
<b>FLANGE</b>	A plate attached to the end of a tube which can be clamped or bolted to a mated component interface. SAE J518 Code 61 or Code 62 defines the dimensional and performance requirements.
<b>FLARE SEAT</b>	The chamfered edge of the fitting, either 24°, 30°, 37° or 45°, where the hydraulic seal is made.
<b>FLUID</b>	A liquid, gas or combination thereof.
<b>FLUID COMPATIBILITY</b>	The hydraulic assembly (tube, cover, reinforcement and couplings) must be fluid-compatible. The correct hose must be used because some hydraulic fluids have drastically different chemical characteristics. Many hoses are compatible with most, but not all, fluids.
<b>FRICTION (FLUID)</b>	The rubbing of fluid against the inside walls of the hose assembly.
<b>HEAT GAIN</b>	The total amount of energy converted to heat energy which will raise the fluid temperature if it is not dissipated.
<b>HOSE LENGTH</b>	Correct hose length determinations include consideration for length, length changes under pressure, machine vibration and motion, and hose assembly routing.
<b>HOSE ROUTING</b>	The most direct or best path a hose uses to connect one port to another. Determine hose lengths and configurations that will result in proper routing and protection from abrasion, snagging or kinking, and provide leak-resistant connections.
<b>LAMINAR FLOW</b>	Liquid particles flowing smoothly in even layers with no cross flow.



## GLOSSARY OF TERMS

<b>LAYLINE</b>	The printed line on the hose cover used as a manual to ensure that the hose lies straight with no twisting.
<b>LOCKING COLLAR</b>	The collar behind the stem hex. When crimped, it interfaces with the ferrule lip and locks the stem and ferrule together.
<b>LOCKOUT/TAGOUT (LO/TO)</b>	The placement of a lockout/tagout device on a power switch, in accordance with an established procedure, to indicate that the power switch and the equipment being controlled may not be operated until the lockout/tagout is removed.
<b>MINIMUM BEND RADIUS</b>	The tightest a hose can be bent prior to exerting excessive force that can cause kinking or damage.
<b>O-RING</b>	A ring that has a round cross section usually used for sealing.
<b>ORIENTATION</b>	The alignment of couplings (bent or block) on a hose assembly.
<b>PEAKS</b>	A marked jump in pressure in a system. Also called spikes or surges.
<b>PERFORATED</b>	The process of making holes in a hydraulic cover. This enables any air or gases to escape (bleed) through and not bubble or blister the cover.
<b>PETROLEUM FLUID</b>	A fluid composed of petroleum oil. It may contain additives.
<b>PINHOLE</b>	A small hole in a hose that can spray fluid at a high pressure.
<b>PORT</b>	Threaded or unthreaded female connection of a fluid power component which is flush with the surface.
<b>PRESSURE</b>	Force per unit area. The distributed reaction (pressure) on a confined fluid is typically measured in pounds per square inch.
<b>PRESSURE DROP</b>	The difference between the pressure of a fluid as it enters one end of a hydraulic hose assembly and the pressure of that fluid as it leaves the other end.
<b>QUICK DISCONNECT</b>	A coupling that can quickly join or separate a fluid line without the use of tools or special devices.
<b>RETURN LINE</b>	The line conducting fluid from working devices to the reservoir.
<b>SAE</b>	Society of Automotive Engineers.
<b>SAE PORT</b>	A straight thread port used to attach tube and hose fittings. It employs an O-ring compressed in a wedge-shaped cavity.
<b>SKIVING</b>	The process of removing the outer cover of a hose before installing the coupling.
<b>SLEEVING</b>	Nylon or cordura sleeving provides excellent abrasion resistance to protect individual hoses; can be used to bundle several hose assemblies together for maximum protection.
<b>STATIC DISCHARGE</b>	Producing stationary charges of electricity.
<b>SUCTION LINE</b>	A supply line at subatmospheric pressure to a pump, compressor or other component.
<b>SWAGE</b>	A method of permanently attaching couplings where the coupling is compressed to the hose by forcing it through a tapered hole in a die.
<b>SYNTHETIC FLUID</b>	Fluid that has been artificially compounded for use in a fluid power system.
<b>TORQUE</b>	A rotational twisting force.
<b>TURBULENT FLOW</b>	A flow situation in which the fluid particles move in a random manner.
<b>VACUUM</b>	Pressure less than atmospheric pressure. It is usually expressed in inches of mercury (in. Hg) as referred to the existing atmospheric pressure.
<b>VELOCITY</b>	The time rate (speed) of linear motion in a given direction.
<b>VISCOSITY</b>	A measure of the internal friction or the resistance of a fluid to flow.
<b>VISCOSITY INDEX</b>	A measure of how viscosity changes in relation to temperature.
<b>WATER-GLYCOL FLUID</b>	A fluid whose major constituents are water and one or more glycols or polyglycols.
<b>WORKING PRESSURE</b>	The pressure at which the hydraulic system operates. Pressure surges or peaks exceeding the rated working pressure are destructive and must be taken into account when selecting a hose.



**DRIVEN BY POSSIBILITY™**

## **HYDRAULIC HOSE + COUPLINGS SAFE HYDRAULICS**

### **PROPER INSTALLATION + PREVENTIVE MAINTENANCE PROCEDURES**

Improve workplace safety, reduce downtime, and increase production.

There are several valid reasons to begin a preventive maintenance program. Costly emergency repairs, production downtime and worker safety are just a few. This thorough textbook provides in-depth guidance to avoid these issues to improve hydraulic hose performance. Ideal for facility personnel responsible for managing hydraulic hose assemblies, the Gates Safe Hydraulics program covers the following topics:

- Hydraulic Hose Safety
- Periodic Inspections
- Hydraulic Hose Risk Management
- Troubleshooting
- Hydraulic Hose Selection
- Coupling Selection
- Proper Hose Assembly
- Installing Hose Assemblies
- Crimper Preventive Maintenance

**GATES CORPORATION OFFERS ONSITE SAFE HYDRAULICS TRAINING. TO SCHEDULE TRAINING OR TO LEARN MORE, CONTACT AN AUTHORIZED GATES DISTRIBUTOR OR VISIT [GATESSAFETY.COM](https://www.gatesafety.com)**